

**Spectral90**  
**KATLAR ARASI DOGRAMA SİSTEMİ**  
**WINDOW WALL SYSTEM**

<b>A</b>	<b>ALUMİNYUM PROFİLLER</b> ALUMINIUM PROFILES .....	A-01 / A-09
<b>B</b>	<b>CAM MONTAJ TALİMATI</b> GLAZING ASSEMBLY .....	B-01 / B-09
<b>C</b>	<b>CONTALAR</b> GASKETS .....	C-01 / C-05
<b>D</b>	<b>AKSESUARLAR</b> ACCESSORIES .....	D-01 / D-12
<b>E</b>	<b>TAM ÖLÇEKLİ PROFİLLER</b> FULL SCALE PROFILES .....	E-01 / E-27
<b>F</b>	<b>PRENSİP SİSTEM DETAYLARI</b> PRINCIPAL SECTIONS .....	F-01 / F-70
<b>G</b>	<b>ÜRETİM TALİMATLARI</b> MANUFACTURING INSTRUCTIONS .....	G-01 / G-68

## SİSTEM ÖZELLİKLERİ / SYSTEM FEATURES



- KASA DERİNLİĞİ 90mm FRAME DEPTH 3 1/2"
- CAM KALINLIK OPSİYONU 24mm den 50mm ye kadar  
GLAZING OPTIONS WITH 1", AND 2"
- YÜKSEK ISI PERFORMANSI (0.22 BTU/h ft2 F)  
IMPROVED THERMAL PERFORMANCE (UP TO 0.22 Btu/h ft2 F)
- ÇOKLU UYGULAMA SECENEGİ,(SÜREKLİ-KAT  
ARASI-RECEPTORLU VE RESEPTORSÜZ-DÖŞEME ÖNÜ  
LEVHA-GÖLGE KUTULU)  
MULTIPLE INSTALLATION OPTIONS (BYPASS, SLAB TO SLAB  
OPTION, SUB-SILL/ SIDE JAMB RECEPTOR, BREAK METAL SLAB  
COVER, SHADOW BOX SPANDRELS)
- İÇERİDEN CAM DEĞİŞİMİ  
OPERABLE CAN BE REPLACED FROM INSIDE
- ÇEŞİTLİ AÇILIR PENCERE ŞEKİLLERİ (GİZLİ KANAT-BONDİNGLİ  
GİZLİ KANAT-TOP HUNG-BONDİNGLİ TOP HUNG-KLASİK  
PENCERE-İÇE VE DIŞA AÇILIR BİNİLİ VE HEMYÜZ KAPI)  
VARIOUS OPTIONS FOR OPERABLE (PROJECT OUT WITH OS  
OR EURO CRANK OPERATOR, TILT AND TURN WITH HIDDEN  
SASH, BALCONY DOOR)
- HIZLI ÜRETİM,HIZLI MONTAJ,DAHA AZ SİLİKON VE VİDA  
KULLANIMI,ISIL UZAMADAN KAYNAKLI SESİN AZALTILMASI  
FAST INSTALLATION WITH INTEGRATED SNAP IN SYSTEM  
(REDUCED CAULK AND FASTENER USAGE, NO METAL TO  
METAL CONNECTION TO REDUCE POPPING SOUND CAUSED  
BY THERMAL EXPANSION BETWEEN UNITS)
- SERT KÖPÜK EKLENME OPSİYONU  
HARD FOAM THERMAL INSERTS

## OPSİYONEL ÖZELLİKLER / OPTIONAL FEATURES





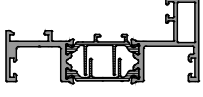
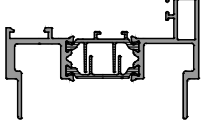
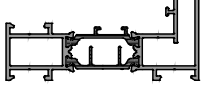
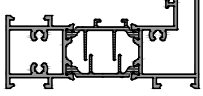

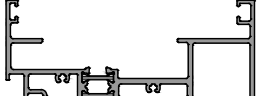
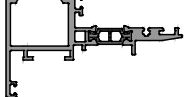
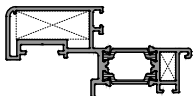
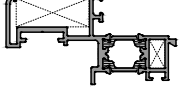
- LOW-E KAPLAMASI & ARGON DOLGULU CAM  
LOW-E COATING & ARGON FILLED IGU
- ÖZEL RENK VE BİTİŞ (İÇ-DIŞ FARKLI RENK OPSİYONU)  
CUSTOM COLOR & FINISH (TWO TONE OPTION)
- ÇELİK YADA ALUMİNYUM TAKVİYE İLE GÜÇLENDİRME  
STEEL INSERTS FOR STRUCTURAL IMPROVEMENT

**Spectral90**  
**KATLAR ARASI DOGRAMA SİSTEMİ**  
**WINDOW WALL SYSTEM**

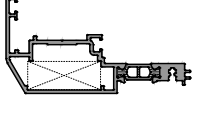



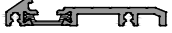

**ALUMİNYUM PROFİLLER**  
**ALUMINIUM PROFILES**

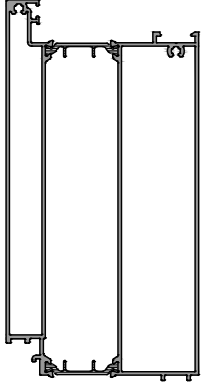
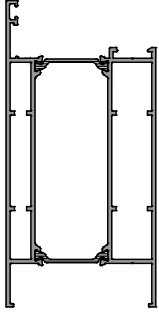
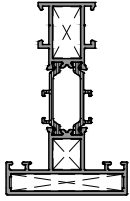
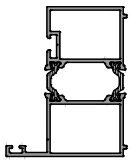
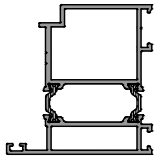
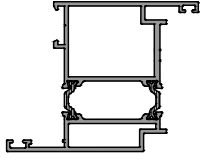
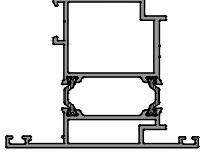

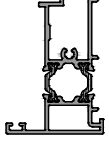
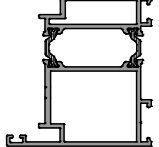
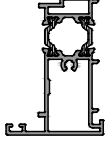
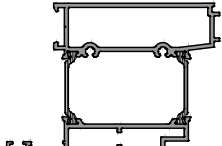

PROFİL ŞEKLİ PROFILE SECTION	PROFİL ADI PROFILE NO	KALIP KODU DIE NO	PROFİL TANIMI PROFILE DESCRIPTION	AĞIRLIK WEIGHT
	P 2525		DİŞİ MÜLYON PROFİLİ Female Mullion Profile	1,575kg/mt
	P 2526		ERKEK MÜLYON PROFİLİ Male Mullion Profile	1,845kg/mt
	P 2527	18092 + .....	YAN KASA PROFİLİ Side Frame Profile	1,455kg/mt
	P 2528		ALT-ÜST KASA PROFİLİ Top-Bottom Frame Profile	1,860kg/mt
	P 2529		ÜST RECEPTOR PROFİLİ Top Receptor profile	1,820kg/mt
	P 1715	16081	RECEPTOR ÇITA PROFİLİ Receptor Slat Profile	0,570kg/mt
	P 2530		ALT RECEPTOR PROFİLİ Sill Receptor profile	2,170kg/mt
	P 2409	18908 17085	GİZLİ KANAT PROFİLİ Hidden Sash Profile	1,460kg/mt
	P 2508	16092 + 16093	VASİSTAS PENCERE KANAT PROFİLİ sash profile for top hung	1,490kg/mt
	P 2509	16092 + .....	VASİSTAS PENCERE KANAT PROFİLİ sash profile for top hung	1,450kg/mt







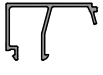

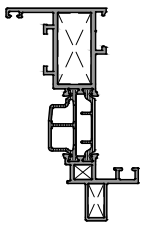
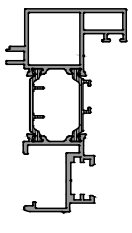

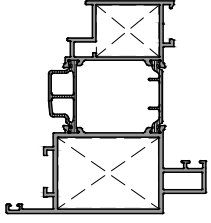
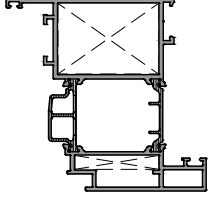
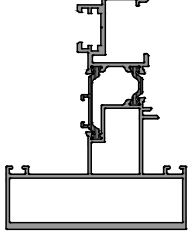





PROFİL ŞEKLİ PROFILE SECTION	PROFİL ADI PROFILE NO	KALIP KODU DIE NO	PROFİL TANIMI PROFILE DESCRIPTION	AĞIRLIK WEIGHT
	P 2510	..... + 18921	VASİSTAS PENCERE KASA PROFİLİ frame profile for top hung	1,245kg/mt
	P 1699	16094	DIŞ CAM ÇITASI exterior glazing bead profile	0,300kg/mt
	P 2511		GİZLİ KANAT PROFİLİ Hidden Sash Profile	1,095kg/mt
	P 2513		BONDING ÇITA PROFİLİ Bonding Slat Profile	0,470kg/mt
	P 2514		BONDING ÇITA PROFİLİ Bonding Slat Profile	0,400kg/mt
	P 2515		BONDING ÇITA PROFİLİ Bonding Slat Profile	0,320kg/mt
	P 2516		BONDING ÇITA PROFİLİ Bonding Slat Profile	0,250kg/mt
	P 2517		EŞİK PROFİLİ Threshold Profile	0,880kg/mt
	P 1029	18699 + 18700	EŞİK PROFİLİ Threshold Profile	0,710kg/mt
	P 1020	12769	TİJ PROFİLİ (eloxal) rod profile (anodised)	0,105kg/mt

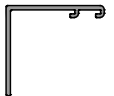

PROFİL ŞEKLİ PROFILE SECTION	PROFİL ADI PROFILE NO	KALIP KODU DIE NO	PROFİL TANIMI PROFILE DESCRIPTION	AĞIRLIK WEIGHT
	P 2518		ETEK PROFİLİ Sill Profile	3,890kg/mt
	P 1215	13933 + 13934	ETEK PROFİLİ Sill Profile	3,150kg/mt
	P 2193	18092 18280	ORTA KAYIT PROFİLİ Mullion Profile	1,770kg/mt
	P 1028	18697 + 18698	ETEK ALT EK PROFİLİ Additional Profile for Sill	1,750kg/mt
	P 1205	13917 + 13918	KAPI KANAT PROFİLİ Door Sash Profile	1,955kg/mt
	P 1206	13919 + 13920	KAPI KANAT PROFİLİ Door Sash Profile	2,115kg/mt
	P 1207	13917 + 13921	KAPI KANAT PROFİLİ Door Sash Profile	2,120kg/mt

PROFİL ŞEKLİ PROFILE SECTION	PROFİL ADI PROFILE NO	KALIP KODU DIE NO	PROFİL TANIMI PROFILE DESCRIPTION	AĞIRLIK WEIGHT
	P 1208	13922 + 13923	ÇİFT KANAT ADAPTÖR PROFİLİ double sash adapter profile	1,275kg/mt
	P 1210	13919 + 13926	KAPI KASA PROFİLİ Door Frame Profile	2,015kg/mt
	P 1211	13927 + 13928	ÇİFT KANAT ADAPTÖR PROFİLİ double sash adapter profile	1,295kg/mt
	P 1334	14211 + 14220	ETEK ÜST EK PROFİLİ Additional Profile for Sill	2,310kg/mt
	P 1176	13698	14mm CAM ÇITASI 14mm glazing bead profile	0,335kg/mt
	P 1179	13671	18mm CAM ÇITASI 18mm glazing bead profile	0,350kg/mt
	P 1180	13670	27mm CAM ÇITASI 27mm glazing bead profile	0,380kg/mt
	P 1105	13113	22mm CAM ÇITASI 22mm glazing bead profile	0,360kg/mt
	P 1158	13111	31mm CAM ÇITASI 31mm glazing bead profile	0,365kg/mt

PROFİL ŞEKLİ PROFILE SECTION	PROFİL ADI PROFILE NO	KALIP KODU DIE NO	PROFİL TANIMI PROFILE DESCRIPTION	AĞIRLIK WEIGHT
	P 1494	15306	10mm CAM ÇITASI 10mm glazing bead profile	0,325kg/mt
	P 1495	15307	6mm CAM ÇITASI 6mm glazing bead profile	0,270kg/mt
	P 1496	15308	2mm CAM ÇITASI 2mm glazing bead profile	0,245kg/mt
	P 1497	15309	40mm CAM ÇITASI 40mm glazing bead profile	0,435kg/mt
	P 1498	15310	36mm CAM ÇITASI 36mm glazing bead profile	0,415kg/mt
	P 1647	15811	EKLEME CAM ÇITASI additional glazing bead profile	0,275kg/mt
	P 2176	18094 + 18095	KANAT PROFİLİ sash profile	1,720kg/mt
	P 2179	18103 + 18104	ÇİFT KANAT ADAPTÖR PROFİLİ double sash adapter profile	1,795kg/mt

PROFİL ŞEKLİ PROFILE SECTION	PROFİL ADI PROFILE NO	KALIP KODU DIE NO	PROFİL TANIMI PROFILE DESCRIPTION	AĞIRLIK WEIGHT
	P 2194	18099 + 18282	DIŞA AÇILIR KAPI PROFİLİ outward opening sash profile	2,500kg/mt
	P 2196	18272 + 18273	İÇE AÇILIR KAPI PROFİLİ inward opening sash profile	2,445kg/mt
	P 2408	18104 18911	ÇİFT KANAT ADAPTÖR PROFİLİ Double Sash Adapter Profile	2,685kg/mt
	P 2414	18910	EK ÇİTA PROFİL Additional Bead Profile	0,235kg/mt
	P 1371	.....	KAPI ÇİTA PROFİL Door Slat Profile	0,170kg/mt
	P 2180		12,5mm CAM ÇİTASI 12,5mm glazing bead profile	0,240kg/mt
	P 2181	18279	18,5mm CAM ÇİTASI 18,5mm glazing bead profile	0,285kg/mt

PROFİL ŞEKLİ PROFILE SECTION	PROFİL ADI PROFILE NO	KALIP KODU DIE NO	PROFİL TANIMI PROFILE DESCRIPTION	AĞIRLIK WEIGHT
	P 2182	18096	25mm CAM ÇITASI 25mm glazing bead profile	0,295kg/mt
	P 2183		30mm CAM ÇITASI 30mm glazing bead profile	0,320kg/mt
	P 2184		36mm CAM ÇITASI 36mm glazing bead profile	0,340kg/mt
	P 2404	1831	DAMLALIK PROFİLİ Dropper Profile	0,160kg/mt
	P 1850	17089	GİZLİ KANAT CAM ÇITASI glazing bead profile for hidden sash	0,100kg/mt
	P 2199	18285	KAPI ALT BİNİ PROFİLİ door bottom bead profile	0,170kg/mt
	P 2519		ÜST RECEPTOR EK PROFİL Additional Slat for Top Receptor	0,515kg/mt
	P 2520		ALT RECEPTOR EK PROFİL Additional Slat for Bottom Receptor	0,355kg/mt
	P 1702	11683	CAM TAŞIYICI PROFİL glass support profile	0,355kg/mt
	P 1849	11184	CAM TAŞIYICI PROFİL glass support profile	0,280kg/mt

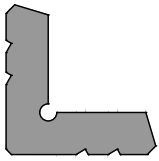
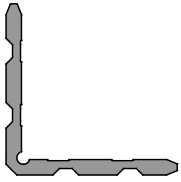
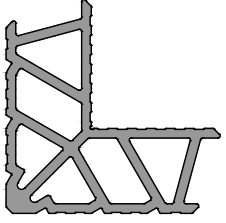
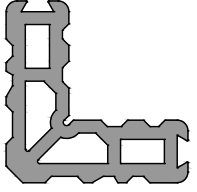
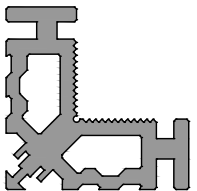
PROFİL ŞEKLİ PROFILE SECTION	PROFİL ADI PROFILE NO	KALIP KODU DIE NO	PROFİL TANIMI PROFILE DESCRIPTION	AĞIRLIK WEIGHT
	P 2278	18733	ALU. MONTAJ ANKRAJ PROFİLİ Alu.Strap Anchor Profile	2,105kg/mt
	P 2269	19023	ALU. MONTAJ ANKRAJ PROFİLİ Alu.Strap Anchor Profile	2,260kg/mt
	P 1015	338	KÖŞE TAKOZ PROFİLİ corner cleat profile	5,990kg/mt
	P 1017	11182	KÖŞE TAKOZ PROFİLİ corner cleat profile	2,505kg/mt
	P 1116	13248	KÖŞE TAKOZ PROFİLİ Corner Cleat Profile	5,710kg/mt
	P 1162	5543	KÖŞE TAKOZ PROFİLİ corner cleat profile	6,705kg/mt
	P 1221	3223	KÖŞE TAKOZ PROFİLİ Corner Cleat Profile	7,065kg/mt

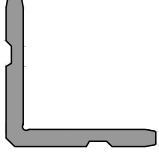
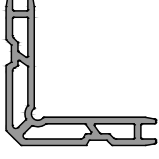
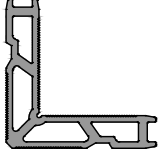
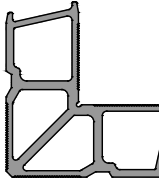
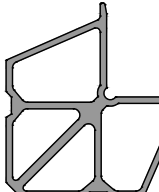
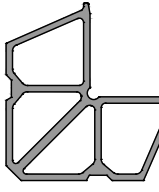
PROFİL ŞEKLİ PROFILE SECTION	PROFİL ADI PROFILE NO	KALIP KODU DIE NO	PROFİL TANIMI PROFILE DESCRIPTION	AĞIRLIK WEIGHT
	P 1574	9083	KÖŞE TAKOZ PROFİLİ corner cleat profile	2,675kg/mt
	P 1701	9084	KÖŞE TAKOZ PROFİLİ (PRES OLARAK KULLANILIR)	2,360kg/mt
	P 2158	5541	KÖŞE TAKOZ PROFİLİ corner cleat profile	2,550 kg/mt
	P 1879	20-5434	KÖŞE TAKOZ PROFİLİ corner cleat profile	3,630kg/mt
	P 2190	9088	KÖŞE TAKOZ PROFİLİ corner cleat profile	3,780kg/mt
	P 2197	9086	KÖŞE TAKOZ PROFİLİ corner cleat profile	3,385kg/mt



**Spectral90**  
**KATLAR ARASI DOGRAMA SİSTEMİ**  
**WINDOW WALL SYSTEM**

**CAM MONTAJ TALİMATI**  
**GLAZING ASSEMBLY**

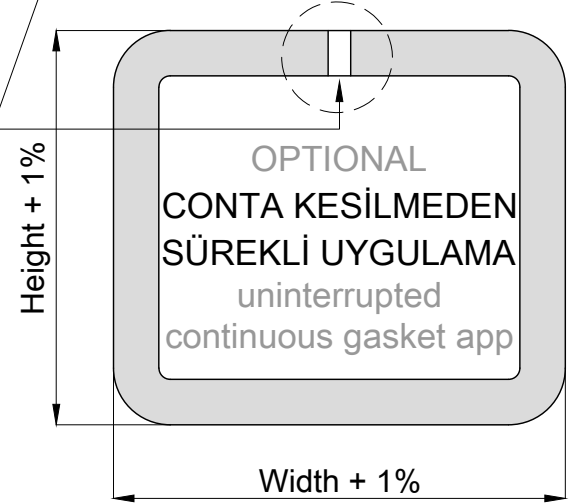
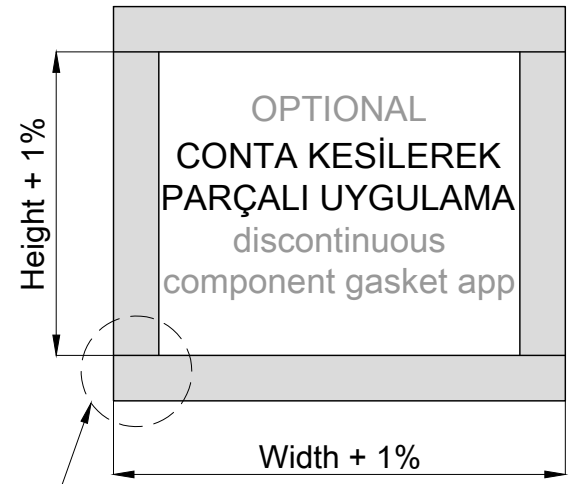
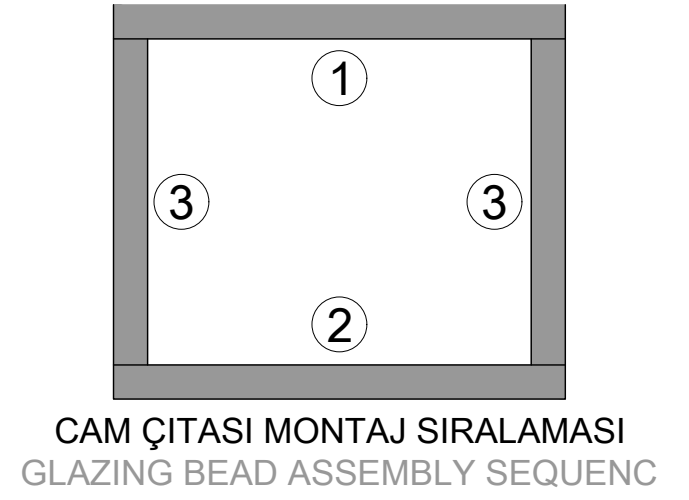
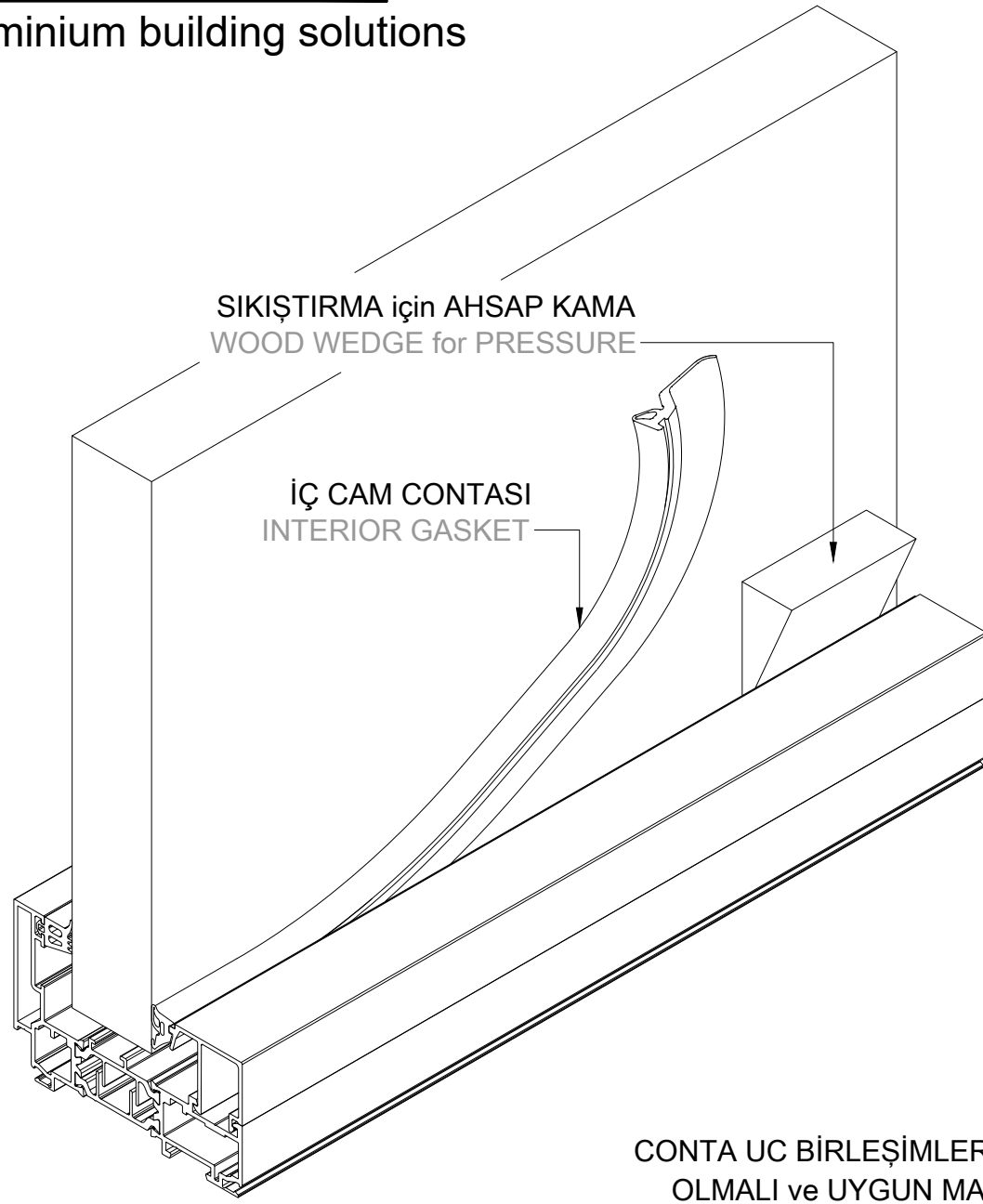

CONTA UC BİRLEŞİMLERİ ÜSTTE  
OLMALI ve UYGUN MASTİK İLE  
YAPIŞTIRILMALI  
GASKET JOINT ON THE TOP,  
BOND WITH EPDM GLUE.

### 1 CAM TAKOZU

Cam takozlari yerlesimi altta bulunan sematik çizimde gösterilmiştir.  
takozlari kenara mesafeleri kanat ölçüsünün 5/1 i yada 10/1 i kadar olmalıdır.

#### GLASS CLEATS

The assembly of glass reinforcement pieces has been showed at the top schemetically. The gap distance to the corner should be, the 5/1 or 10/1 of the sash size.

### 2 MESAFE AYARLAMA TAKOZU

Mesafe ayar takozlari camin alüminyum çerçeve içinde doğru pozisyonda stabil olarak durmasını sağlar.  
cam ile profil arasına takozlari zorlamadan yerleştiriniz.

#### DISTANCE ADJUSTMENT PIECE

Distance adjustment pieces stabilize the glass in the frame at the true position. Put the distance adjustment piece between glass and profile without using force.

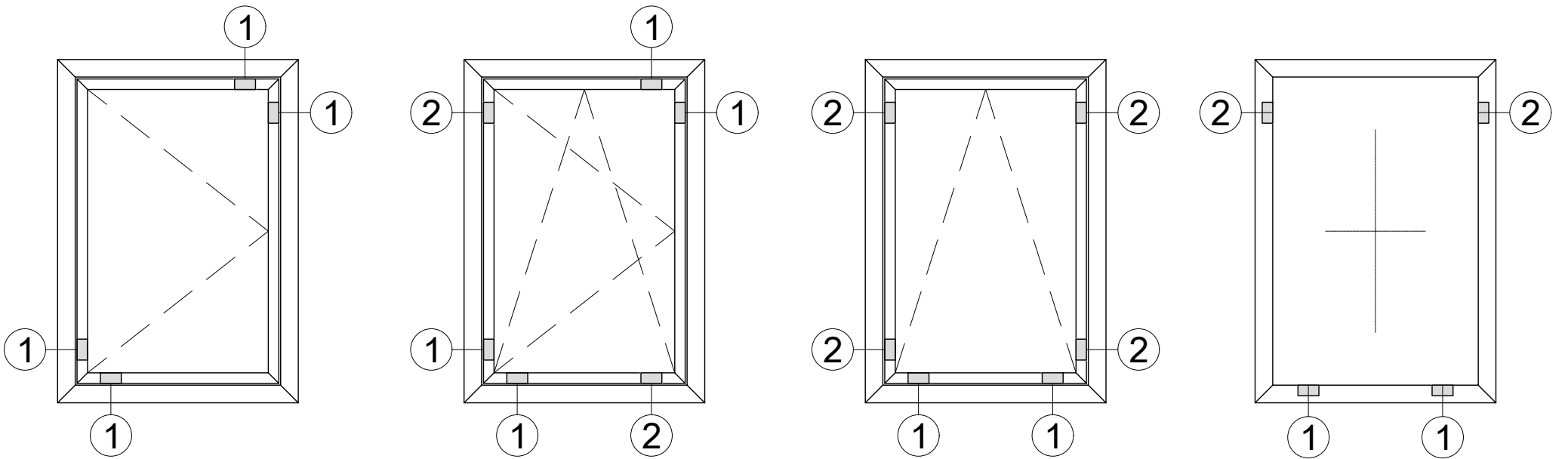

AKSESUAR ve DONANIM MONTAJINDAN ÖNCE,  
CAM ve TAKOZLAMA İŞLEMİ YAPILMALIDIR.

THE PANE MUST BE SHIMMED IN THE SASH SO THAT THE SASH  
OPERATES WITHOUT ADJUSTMENT OF THE HARDWARE.

1 TAŞIYICI TAKOZ  
GLASS CLEAT

2 AYAR TAKOZU  
ADJUSTMENT PIECE

Cam Kalınlığı  
glass thickness

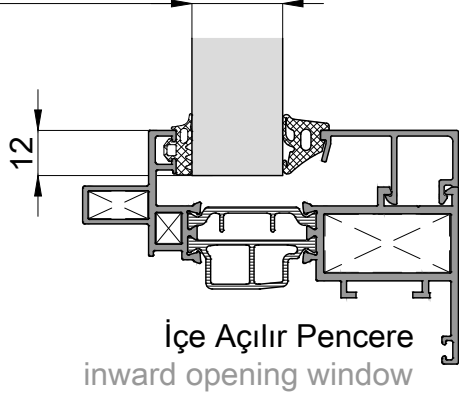

Cam Kalınlığı  
glass thickness

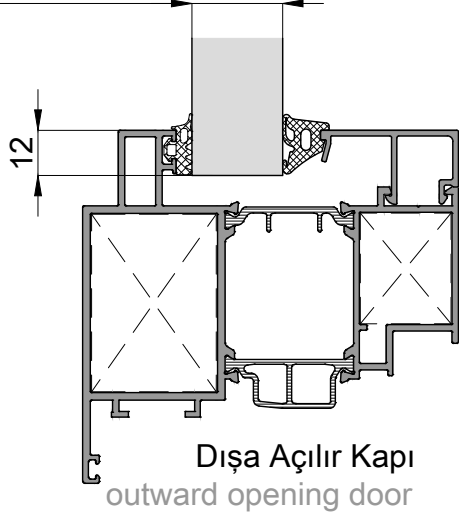

Cam Kalınlığı  
glass thickness

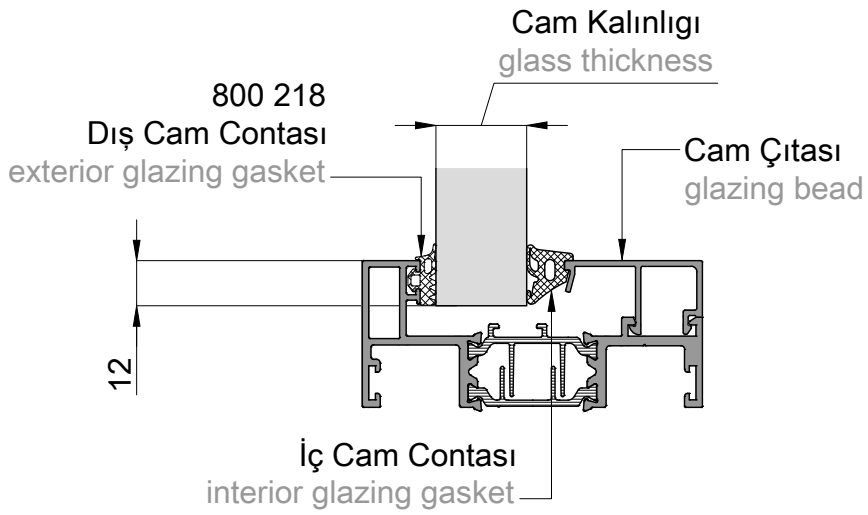
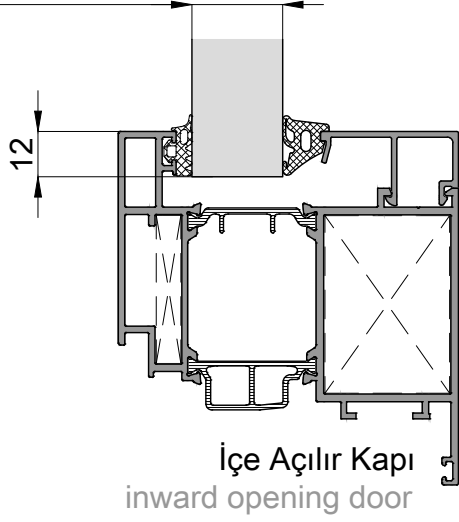

CAM KALINLIĞI glass thickness	ÇITA glazing bead		CAM CONTASI glazing gasket
	profil section	kod code	standart conta without fin gasket
24mm	P 2184 (37mm) 37	37	800 278 (10mm)
26mm			800 277 (8mm)
28mm			800 271 (6mm)
30mm	P 2183 (31mm) 31	31	800 278 (10mm)
32mm			800 277 (8mm)
34mm			800 271 (6mm)
36mm	P 2182 (25mm) 25	25	800 278 (10mm)
38mm			800 277 (8mm)
40mm			800 271 (6mm)
42mm	P 2181 (19mm) 19	19	800 278 (10mm)
44mm			800 277 (8mm)
46mm			800 271 (6mm)
48mm	P 2180 (13mm) 13	13	800 278 (10mm)
50mm			800 277 (8mm)
52mm			800 271 (6mm)



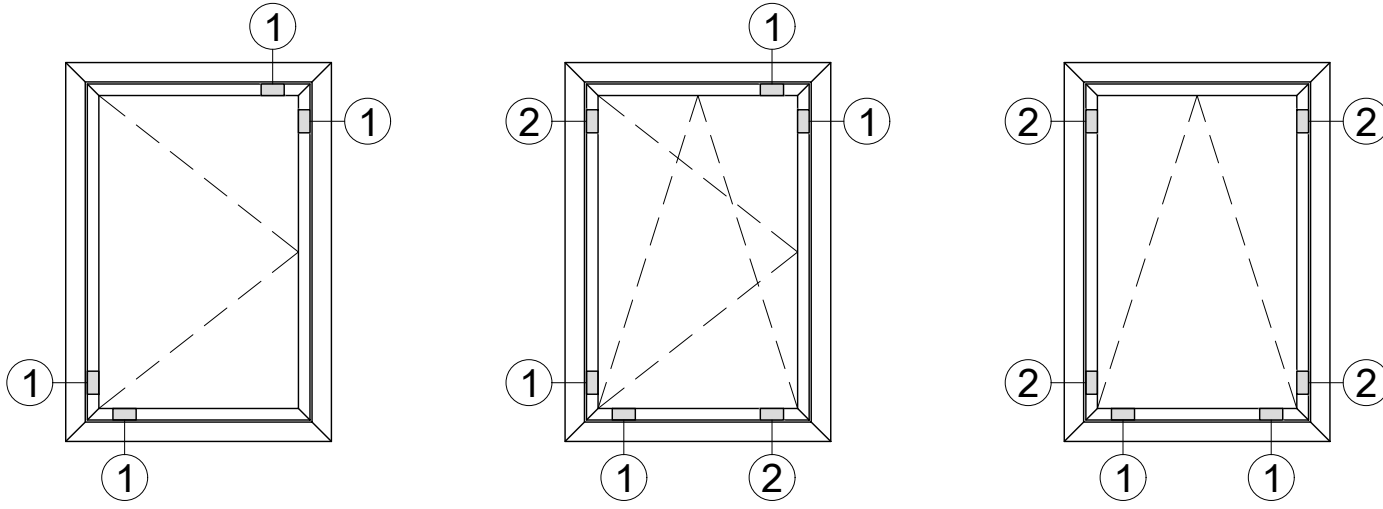



Yanda tablodaki veriler teoriktir.  
Lütfen cam ve conta toleranslarını dikkate alınız.  
selection tables promise a first planning.  
Please keep the glass and gasket tolerances in mind.

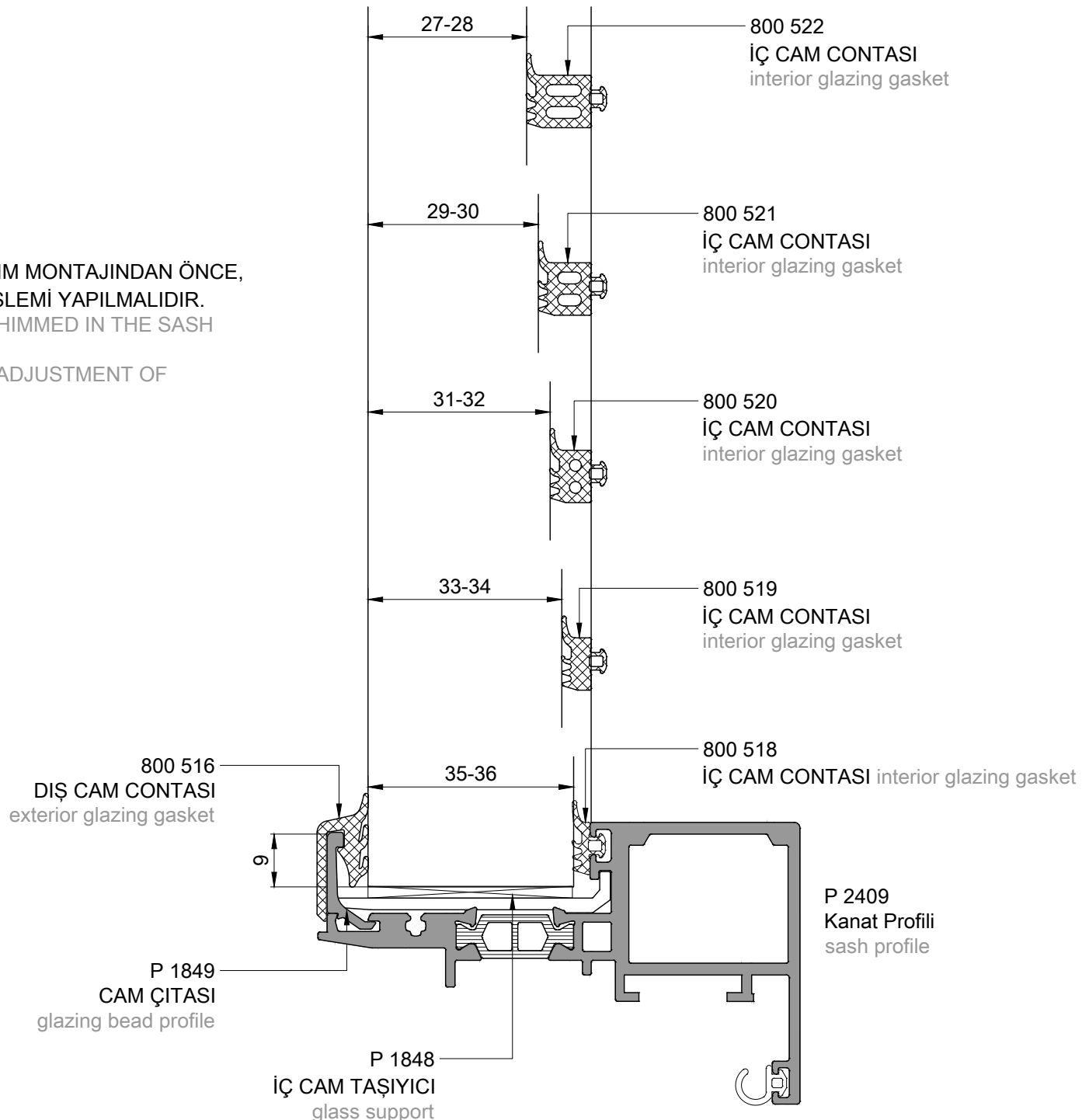

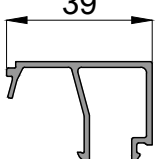

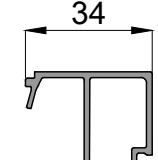





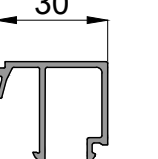

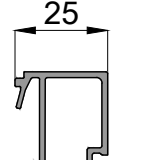



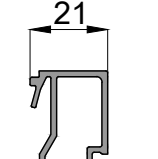

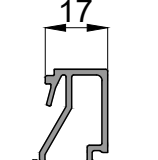
- ① **CAM TAKOZU**  
Cam takozlari yerlesimi altta bulunan sematik çizimde gösterilmiştir. takozların kenara mesafeleri kanat ölçüsünün 5/1 i yada 10/1 i kadar olmalıdır.  
GLASS CLEATS  
The assembly of glass reinforcement pieces has been showed at the top schemetically. The gap distance to the corner should be, the 5/1 or 10/1 of the sash size.
- ② **MESAFE AYARLAMA TAKOZU**  
Mesafe ayar takozlari camin alüminyum çerçeve içinde doğru pozisyonda stabil olarak durmasını sağlar. cam ile profil arasına takozlari zorlamadan yerleştiriniz.  
DISTANCE ADJUSTMENT PIECE  
Distance adjustment pieces stabilize the glass in the frame at the true position. Put the distance adjustment piece between glass and profile without using force.

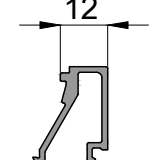
AKSESUAR ve DONANIM MONTAJINDAN ÖNCE,  
CAM ve TAKOZLAMA İŞLEMİ YAPILMALIDIR.  
THE PANE MUST BE SHIMMED IN THE SASH  
SO THAT THE SASH  
OPERATES WITHOUT ADJUSTMENT OF  
THE HARDWARE.

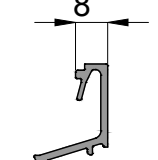

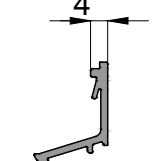
CAM KALINLIĞI glass thickness	ÇITA glazing bead		CAM CONTASI glazing gasket	
	profil section	kod code	conta şekli section	kod code
14mm	P 1498 (39mm) 			800 277 (8mm)
16mm				800 271 (6mm)
18mm	P 1158 (34mm) 			800 278 (10mm)
20mm				800 277 (8mm)
22mm				800 271 (6mm)

CAM KALINLIĞI glass thickness	ÇITA glazing bead		CAM CONTASI glazing gasket	
	profil section	kod code	conta şekli section	kod code
24mm	P 1180 (30mm) 			800 277 (8mm)
26mm				800 278 (10mm)
28mm	P 1105 (25mm) 			800 277 (8mm)
30mm				800 271 (6mm)
32mm				800 277 (8mm)
34mm	P 1179 (21mm) 			800 271 (6mm)
36mm				800 277 (8mm)
38mm	P 1176 (17mm) 			800 271 (6mm)
40mm				800 277 (8mm)
42mm	P 1494 (12mm) 			800 271 (6mm)
44mm				800 277 (8mm)
46mm	P 1495 (8mm) 			800 271 (6mm)
48mm				800 277 (8mm)
50mm	P 1496 (4mm) 			800 271 (6mm)

Cam Kalınlığı  
glass thickness

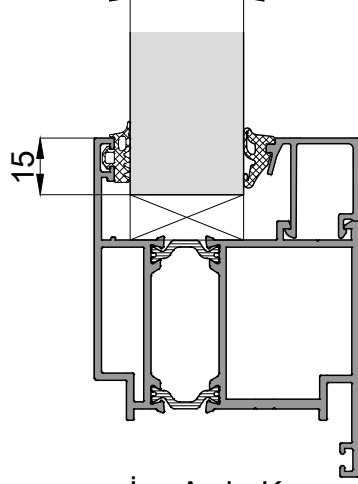

İçe Açılır Kapı  
inward opening door

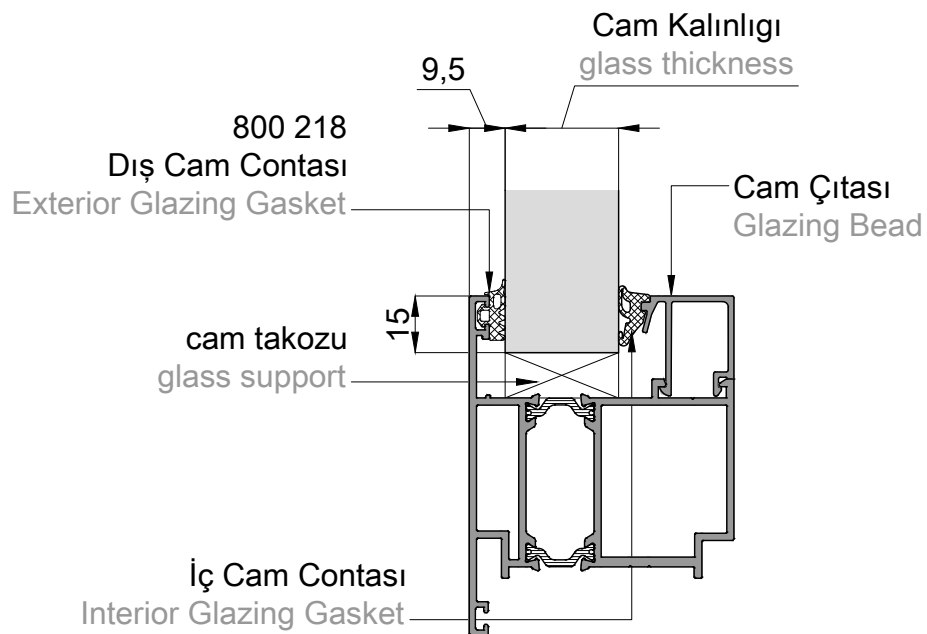

Dışa Açılır Kapı  
outward opening door

Yanda tablodaki veriler teoriktir.  
Lütfen cam ve conta toleranslarını dikkate alınız.  
selection tables promise a first planning.  
Please keep the glass and gasket tolerances in mind.

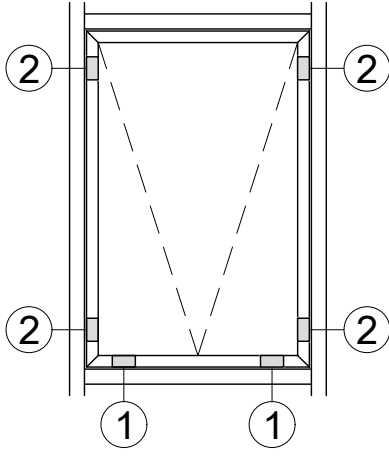

- ① CAM TAKOZU  
Cam takozlari yerlesimi altta bulunan sematik çizimde gösterilmiştir. takozlari kenara mesafeleri kanat ölçüsünün 5/1 i yada 10/1 i kadar olmalıdır.  
GLASS CLEATS  
The assembly of glass reinforcement pieces has been showed at the top schemetically. The gap distance to the corner should be, the 5/1 or 10/1 of the sash size.
- ② MESAFE AYARLAMA TAKOZU  
Mesafe ayar takozlari camin alüminyum çerçeve içinde doğru pozisyonda stabil olarak durmasını sağlar. cam ile profil arasına takozlari zorlamadan yerleştiriniz.  
DISTANCE ADJUSTMENT PIECE  
Distance adjustment pieces stabilize the glass in the frame at the true position. Put the distance adjustment piece between glass and profile without using force.

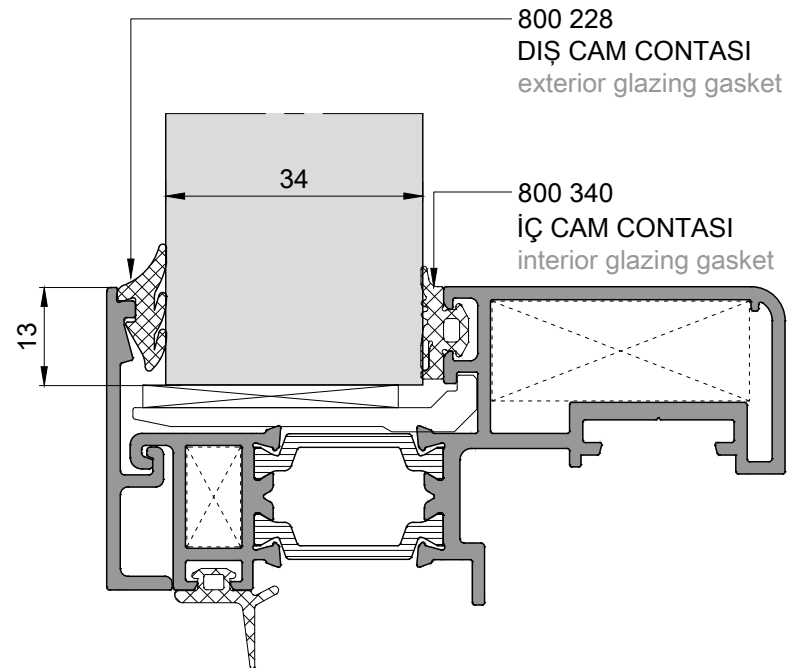
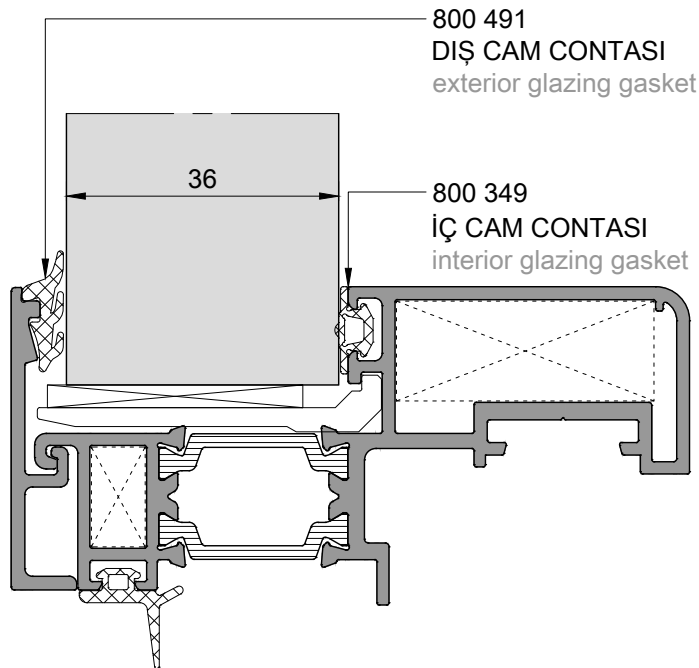
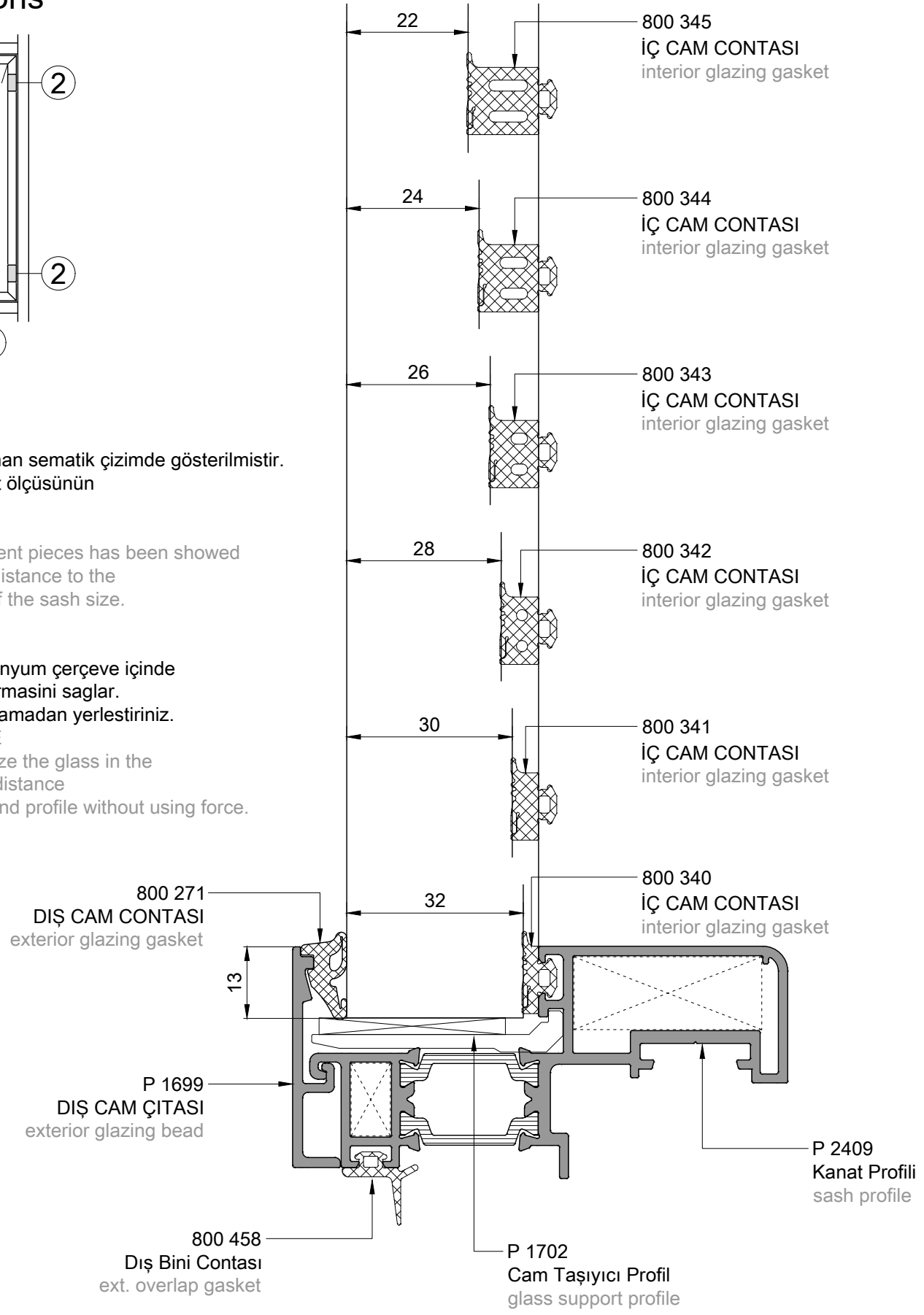

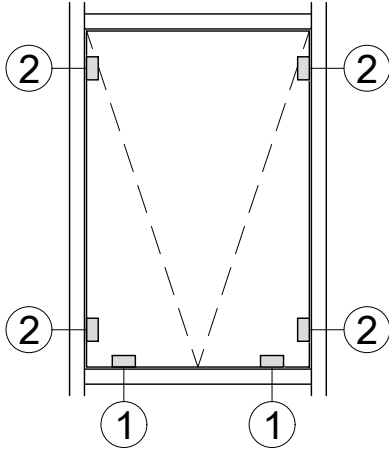

- ① **CAM TAKOZU**  
Cam takozlari yerlesimi altta bulunan sematik çizimde gösterilmiştir. takozların kenara mesafeleri kanat ölçüsünün 5/1 i yada 10/1 i kadar olmalıdır.  
**GLASS CLEATS**  
The assembly of glass reinforcement pieces has been showed at the top schemetically. The gap distance to the corner should be, the 5/1 or 10/1 of the sash size.
- ② **MESAFE AYARLAMA TAKOZU**  
Mesafe ayar takozlari camin alüminyum çerçeve içinde doğru pozisyonda stabil olarak durmasını sağlar. cam ile profil arasına takozlari zorlamadan yerleştiriniz.  
**DISTANCE ADJUSTMENT PIECE**  
Distance adjustment pieces stabilize the glass in the frame at the true position. Put the distance adjustment piece between glass and profile without using force.

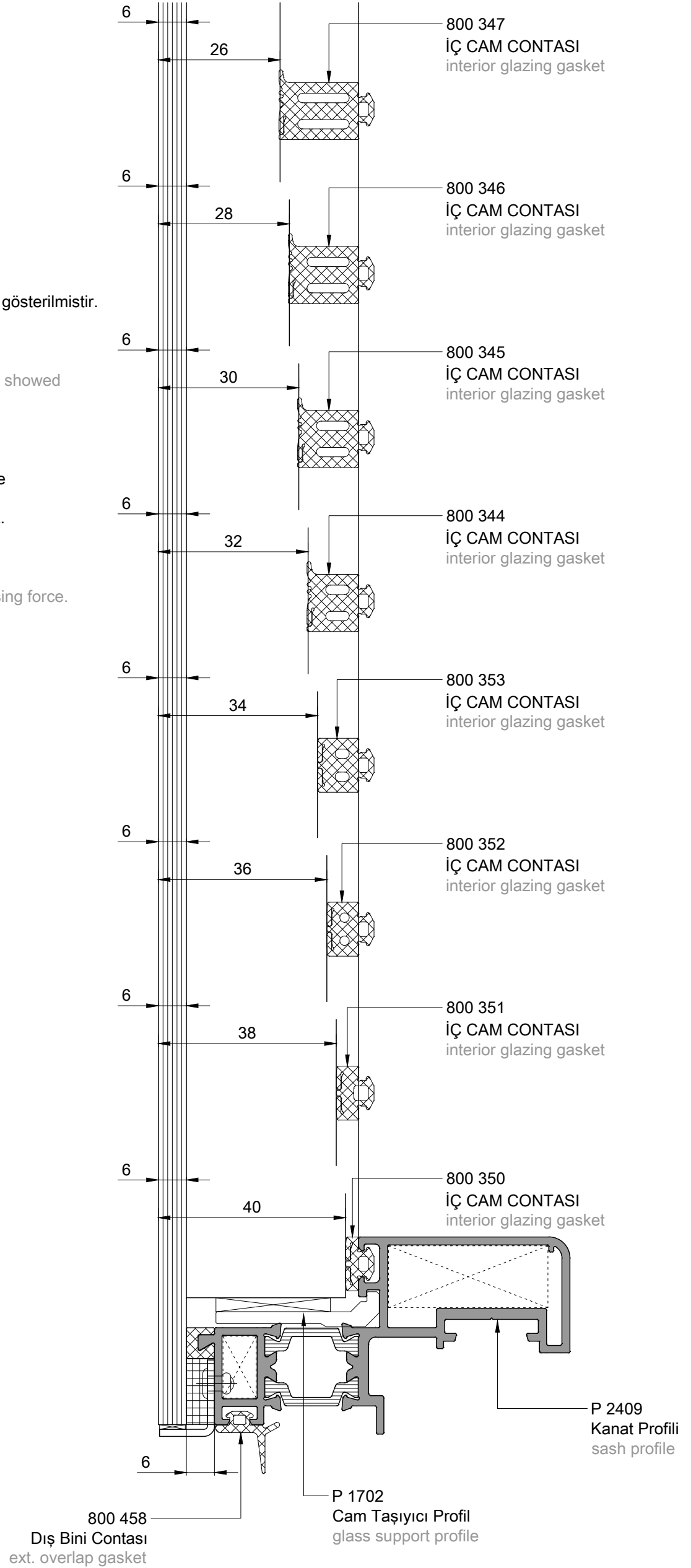

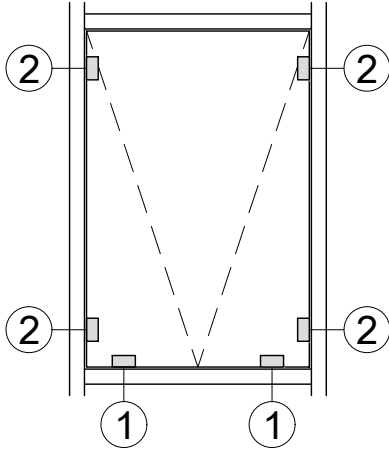

- ① **CAM TAKOZU**  
Cam takozlari yerlesimi altta bulunan sematik çizimde gösterilmistir. takozlari kenara mesafeleri kanat ölçüsünün 5/1 i yada 10/1 i kadar olmalıdır.  
**GLASS CLEATS**  
The assembly of glass reinforcement pieces has been showed at the top schemetically. The gap distance to the corner should be, the 5/1 or 10/1 of the sash size.
- ② **MESAFE AYARLAMA TAKOZU**  
Mesafe ayar takozlari camin alüminyum çerçeve içinde doğru pozisyonda stabil olarak durmasını sağlar. cam ile profil arasına takozlari zorlamadan yerleştiriniz.  
**DISTANCE ADJUSTMENT PIECE**  
Distance adjustment pieces stabilize the glass in the frame at the true position. Put the distance adjustment piece between glass and profile without using force.

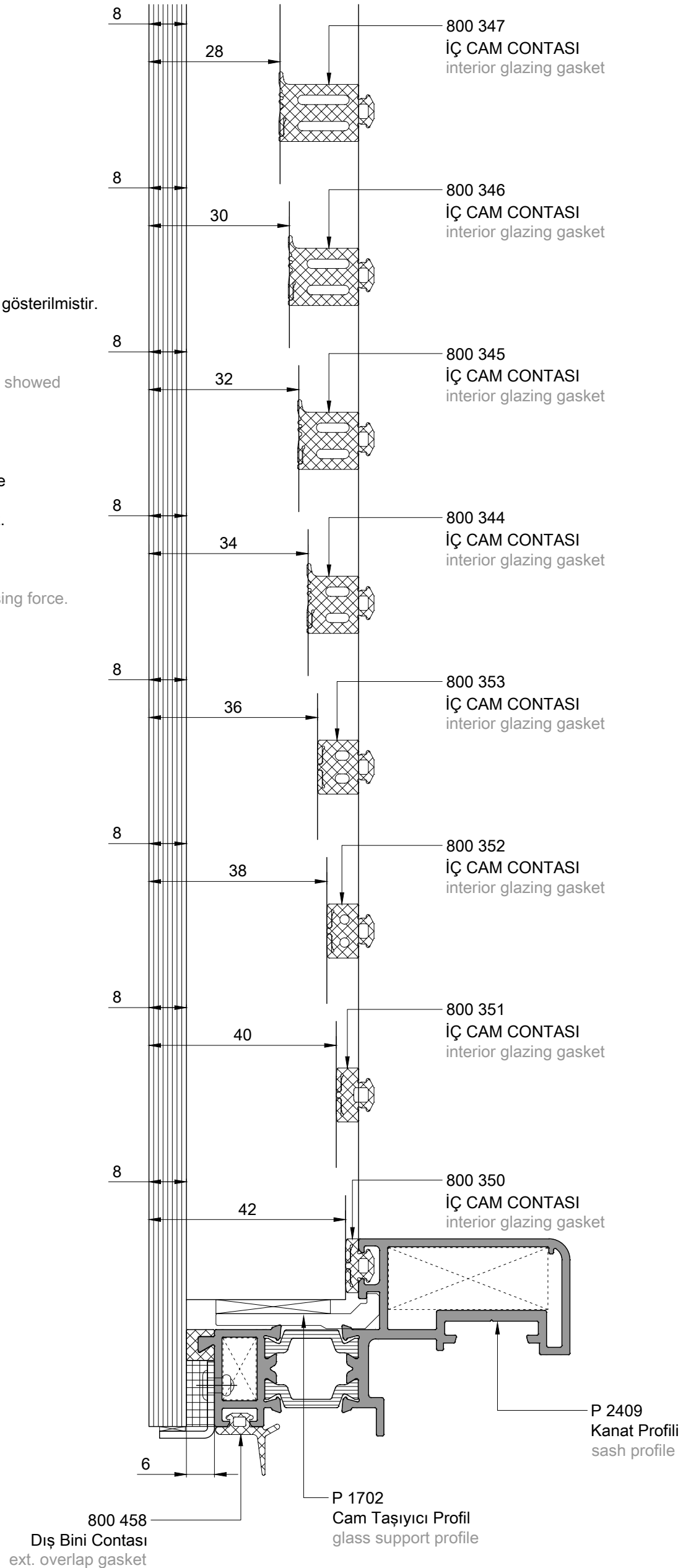



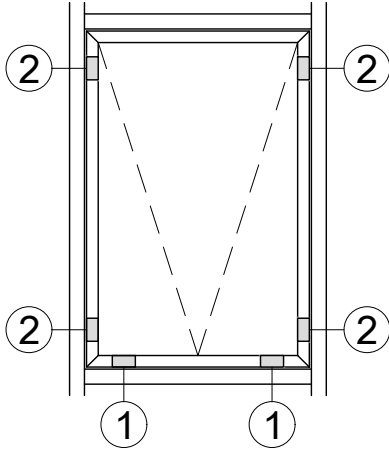

- ① **CAM TAKOZU**  
Cam takozlari yerlesimi altta bulunan sematik çizimde gösterilmiştir. takozların kenara mesafeleri kanat ölçüsünün 5/1 i yada 10/1 i kadar olmalıdır.  
**GLASS CLEATS**  
The assembly of glass reinforcement pieces has been showed at the top schemetically. The gap distance to the corner should be, the 5/1 or 10/1 of the sash size.
- ② **MESAFE AYARLAMA TAKOZU**  
Mesafe ayar takozlari camin alüminyum çerçeve içinde doğru pozisyonda stabil olarak durmasını sağlar. cam ile profil arasına takozlari zorlamadan yerleştiriniz.  
**DISTANCE ADJUSTMENT PIECE**  
Distance adjustment pieces stabilize the glass in the frame at the true position. Put the distance adjustment piece between glass and profile without using force.

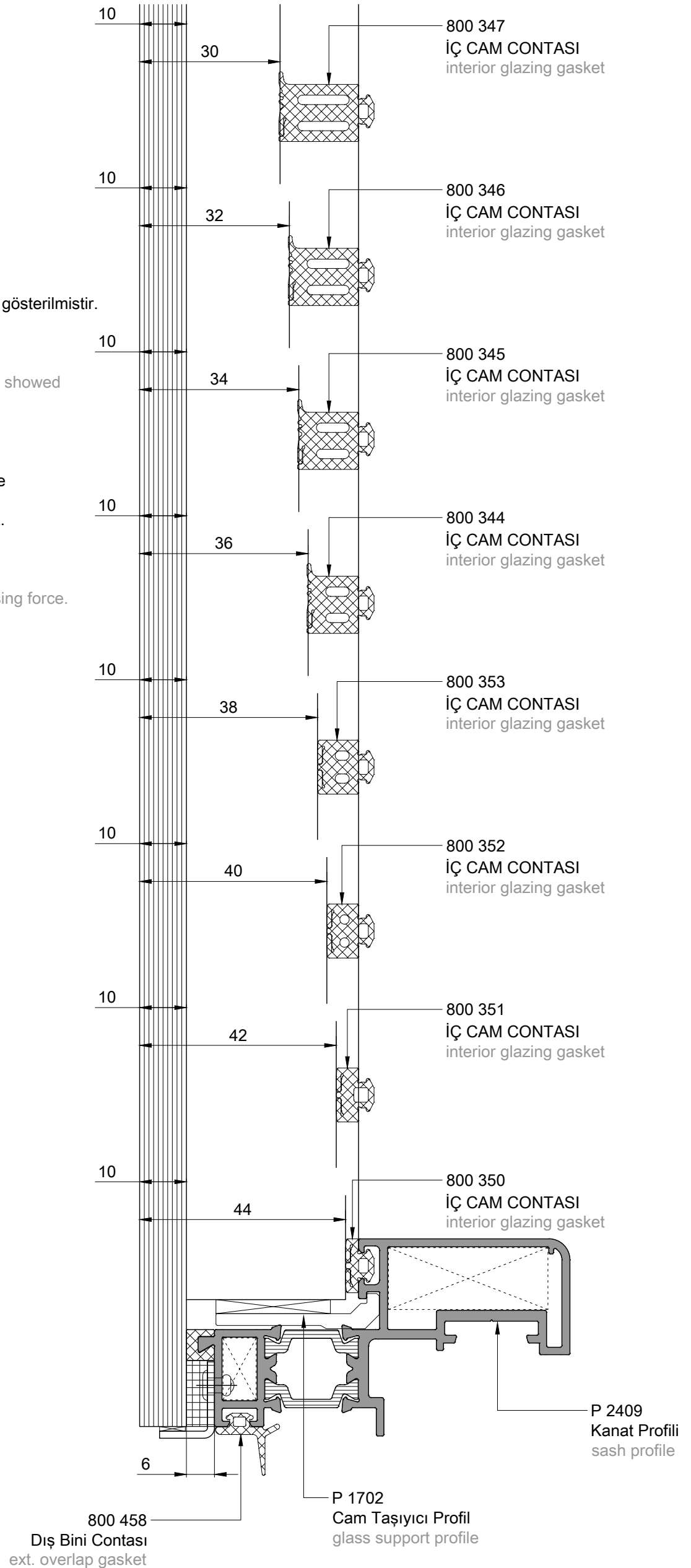

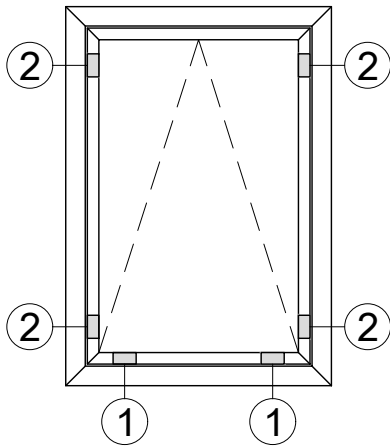
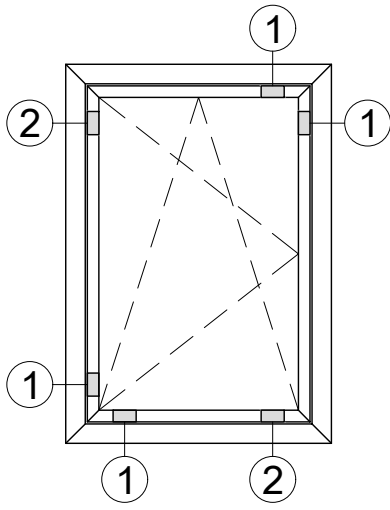
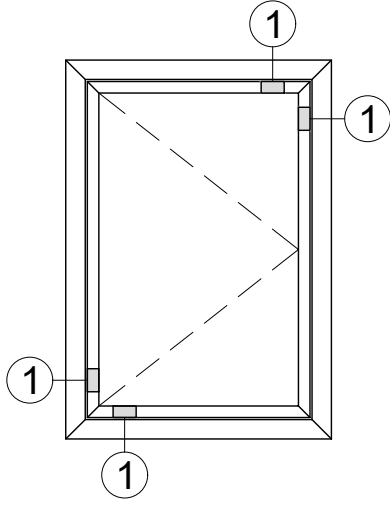





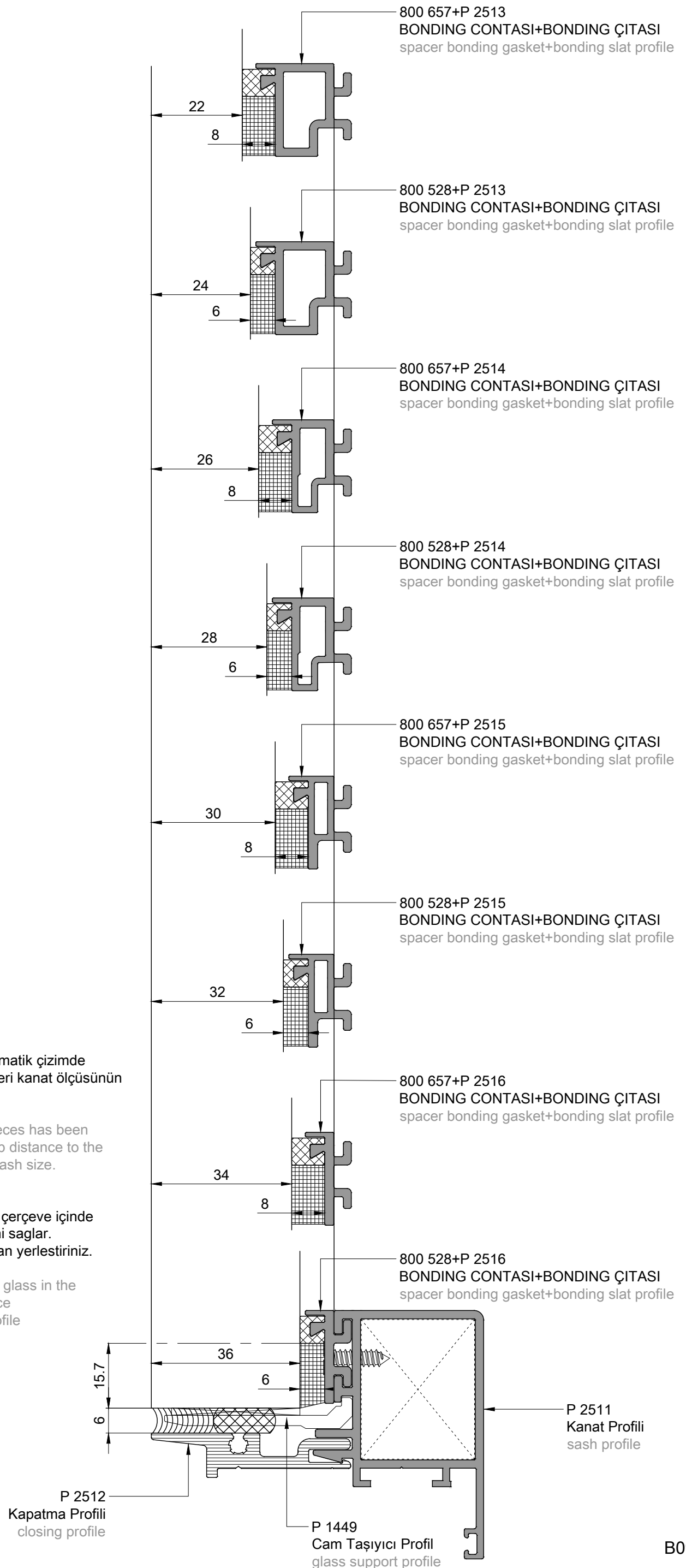





- ① CAM TAKOZU  
Cam takozlari yerlesimi altta bulunan sematik çizimde gösterilmiştir. takozların kenara mesafeleri kanat ölçüsünün 5/1 i yada 10/1 i kadar olmalıdır.  
GLASS CLEATS  
The assembly of glass reinforcement pieces has been showed at the top schematically. The gap distance to the corner should be, the 5/1 or 10/1 of the sash size.











- ② MESAFE AYARLAMA TAKOZU  
Mesafe ayar takozlari camin alüminyum çerçeve içinde doğru pozisyonda stabil olarak durmasını sağlar. cam ile profil arasına takozlari zorlamadan yerleştiriniz.  
DISTANCE ADJUSTMENT PIECE  
Distance adjustment pieces stabilize the glass in the frame at the true position. Put the distance adjustment piece between glass and profile without using force.













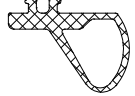









**Spectral90**  
**KATLAR ARASI DOGRAMA SİSTEMİ**  
WINDOW WALL SYSTEM

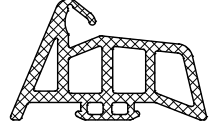

**CONTALAR**  
GASKETS

CONTA ŞEKLİ GASKET SECTION	CONTA KODU GASKET NO	MALZEME MATERIAL	CONTA TANIMI GASKET DESCRIPTION	PAKET PACKAGE
	800 203	EPDM	İÇ BİNİ CONTASI interior overlap gasket	300mt/pk 0,046kg/mt
	800 218	EPDM	DIŞ CAM CONTASI exterior glazing gasket	200mt/pk 0,072kg/mt
	800 228	EPDM	İÇ CAM CONTASI interior glazing gasket	185mt/paket 0,081kg/mt
	800 271	EPDM	İÇ CAM CONTASI interior glazing gasket	185mt/pk 0,081kg/mt
	800 277	EPDM	İÇ CAM CONTASI interior glazing gasket	165mt/pk 0,092kg/mt
	800 278	EPDM	İÇ CAM CONTASI interior glazing gasket	115mt/pk 0,130kg/mt
	800 302	EPDM	İÇ CAM CONTASI interior glazing gasket	235mt/paket 0,064kg/mt
	800 331	EPDM	DIŞ BİNİ CONTASI exterior overlap gasket	285mt/pk 0,035kg/mt
	800 332	EPDM	İÇ BİNİ CONTASI interior overlap gasket	370mt/pk 0,027kg/mt
	800 340	EPDM	3mm İÇ CAM CONTASI 3mm interior glazing gasket	234mt/paket 0,064kg/mt

CONTA ŞEKLİ GASKET SECTION	CONTA KODU GASKET NO	MALZEME MATERIAL	CONTA TANIMI GASKET DESCRIPTION	PAKET PACKAGE
	800 341	EPDM	5mm İÇ CAM CONTASI 5mm interior glazing gasket	156mt/paket 0,096kg/mt
	800 342	EPDM	7mm İÇ CAM CONTASI 7mm interior glazing gasket	125mt/paket 0,120kg/mt
	800 343	EPDM	9mm İÇ CAM CONTASI 9mm interior glazing gasket	103mt/paket 0,146kg/mt
	800 344	EPDM	11mm İÇ CAM CONTASI 11mm interior glazing gasket	90mt/paket 0,167kg/mt
	800 345	EPDM	13mm İÇ CAM CONTASI 13mm interior glazing gasket	79mt/paket 0,189kg/mt
	800 346	EPDM	15mm İÇ CAM CONTASI 15mm interior glazing gasket	71mt/paket 0,210kg/mt
	800 347	EPDM	17mm İÇ CAM CONTASI 17mm interior glazing gasket	65mt/paket 0,231kg/mt
	800 350	EPDM	3mm İÇ CAM CONTASI 3mm interior glazing gasket	268mt/paket 0,056kg/mt
	800 351	EPDM	5mm İÇ CAM CONTASI 5mm interior glazing gasket	183mt/paket 0,082kg/mt
	800 352	EPDM	7mm İÇ CAM CONTASI 7mm interior glazing gasket	139mt/paket 0,108kg/mt

CONTA ŞEKLİ GASKET SECTION	CONTA KODU GASKET NO	MALZEME MATERIAL	CONTA TANIMI GASKET DESCRIPTION	PAKET PACKAGE
	800 353	EPDM	9mm İÇ CAM CONTASI 9mm interior glazing gasket	113mt/paket 0,133kg/mt
	800 386	EPDM	KAPI BİNİ CONTASI overlap gasket for door	481mt/pk 0,027kg/mt
	800 398	EPDM	KAPI ALT BİNİ CONTASI Door Bottom Overlap Gasket	115mt/pk 0,131kg/mt
	800 399	EPDM	EŞİK KANAL CONTASI Closing Gasket for Threshold	481mt/pk 0,027kg/mt
	800 458	EPDM	TOP HUNG BİNİ CONTASI overlap gasket for top hung	300mt/paket 0,050kg/mt
	800 491	EPDM	3mm İÇ CAM CONTASI 3mm interior glazing gasket	240mt/pk 0,054kg/mt
	800 516	EPDM	GİZLİ KANAT DIŞ CAM CONTASI exterior glazing gasket for hidden sash	150mt/pk 0,099kg/mt
	800 518	EPDM	3mm İÇ CAM CONTASI 3mm interior glazing gasket	303mt/pk 0,033kg/mt
	800 519	EPDM	5mm İÇ CAM CONTASI 5mm interior glazing gasket	268mt/pk 0,056kg/mt
	800 520	EPDM	7mm İÇ CAM CONTASI 7mm interior glazing gasket	211mt/pk 0,071kg/mt

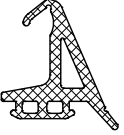

CONTA ŞEKLİ GASKET SECTION	CONTA KODU GASKET NO	MALZEME MATERIAL	CONTA TANIMI GASKET DESCRIPTION	PAKET PACKAGE
	800 521	EPDM	9mm İÇ CAM CONTASI 9mm interior glazing gasket	178mt/pk 0,084kg/mt
	800 522	EPDM	11mm İÇ CAM CONTASI 11mm interior glazing gasket	155mt/pk 0,097kg/mt
	800 528	SİLİKON silicone	BONDING CONTASI spacer gasket for bonding	276mt/paket 0,047gr/mt
	800 657	SİLİKON silicone	BONDING CONTASI spacer gasket for bonding	220mt/paket 0,068gr/mt
	800 545	EPDM	ORTA SIZDIRMAZLIK CONTASI central tightness gasket	45mt/pk 0,330kg/mt
	800 546	EPDM	DIŞ BİNİ CONTASI exterior overlap gasket	190mt/pk 0,080kg/mt
	800 558	EPDM	ÜST KASA CONTASI Top Receptor gasket	227mt/pk 0,066kg/mt
	800 559	EPDM	SIZDIRMAZLIK CONTASI tightness gasket	600mt/pk 0,022kg/mt
	800 514	EPDM	ÜST KASA PROFİLİ CONTASI Top Receptor internal gasket	119mt/pk 0,126kg/mt
	800 590	EPDM	KANAT SIZDIRMAZLIK CONTASI Tightness Gasket For Awning Sash	272mt/pk 0,055kg/mt

CONTA ŞEKLİ GASKET SECTION	CONTA KODU GASKET NO	MALZEME MATERIAL	CONTA TANIMI GASKET DESCRIPTION	PAKET PACKAGE
	800 591	EPDM	KASA SIZDIRMAZLIK CONTASI Tightness Gasket For Awning Frame	300mt/pk 0,050kg/mt
	800 608	EPDM	DIŞ CAM CONTASI exterior glazing gasket	144mt/pk 0,104kg/mt
	800 609	EPDM	ORTA SIZDIRMAZLIK CONTASI central tightness gasket	84mt/pk 0,178kg/mt
	800 622	EPDM	KAPI ALT BİNİ CONTASI Door Bottom Overlap Gasket	267mt/pk 0,056kg/mt
	800 656	EPDM	KAPI ALT BİNİ CONTASI Door Bottom Overlap Gasket	123mt/pk 0,121kg/mt
	800 658	EPDM	KAPI ALT BİNİ CONTASI Door Bottom Overlap Gasket	428mt/pk 0,035kg/mt



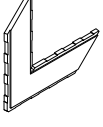
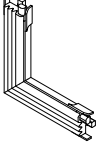
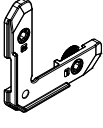
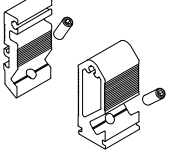

**Spectral90**  
**KATLAR ARASI DOGRAMA SİSTEMİ**  
**WINDOW WALL SYSTEM**

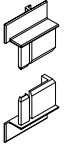
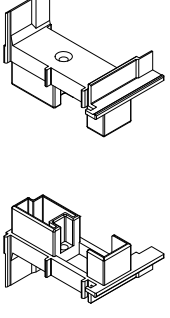

**AKSESUARLAR**  
**ACCESSORIES**

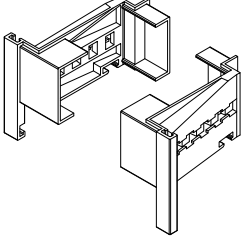
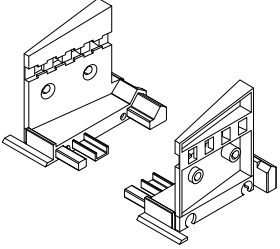
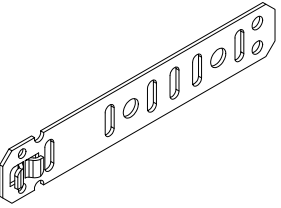
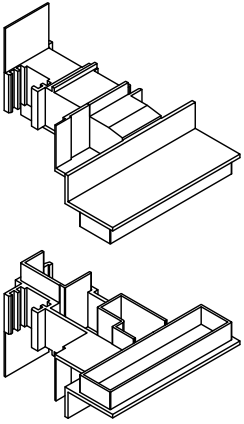
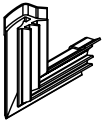
AKSESUAR ŞEKLİ ACCESSORIES SHAPE	AKSESUAR ACCESS. NO	AKSESUAR TANIMI ACCESSORIES DESCRIPTION	MİKTAR QUANTITY
	700 303	PVC KÖŞE ONBAŞI pvc corner angle	500 adet/pieces
	700 305	DIŞ CAM CONTASI İÇİN KÖŞE VULKANİZE vulcanized corner for ext. glazing gasket	50 adet/pieces
	700 322	ALUMİNYUM SIKIŞTIRMALI ONBAŞI aluminium corner with allen key	250 adet/pieces
	700 333	KAPI ve ETEK BİRLEŞİM ANKRAJI T connection bracket for door and sill	50 çift/pair
	700 334	KASA İÇİN PVC ONBAŞI pvc corner angle for sash and frame	500 adet/pieces
	700 336	SU TAHLİYE KAPAGI weep hole cap	500 adet/pieces
	700 385	KANAT 45° BİRLEŞİM EK BİNİ pvc cap plug for 45° cut sash corner	100 çift/pair
	700 386	İÇE AÇILIR KAPI ÇİFT KANAT ADAPTÖR PROFİLİ ALT ve ÜST KAPAGI pvc cap plug for inward opening double sash adapter profile	50 çift/pair

AKSESUAR ŞEKLİ ACCESSORIES SHAPE	AKSESUAR ACCESS. NO	AKSESUAR TANIMI ACCESSORIES DESCRIPTION	MİKTAR QUANTITY
	700 387	DIŞA AÇILIR KAPI ÇİFT KANAT ADAPTÖR PROFİLİ ALT ve ÜST KAPAGI pvc cap plug for outward opening double sash adapter profile	50 çift/pair
	700 519	KANAT 45° BİRLEŞİM EK BİNİ pvc cap plug for 45° cut sash corner	100 çift/pair
	700 685	KASA ve ORTA KAYIT BİRLEŞİM SÜNGERİ T connection foam for frame and mullion	50 adet/pieces
	700 686	KASA ve ORTA KAYIT BİRLEŞİM ANKRAJI T connection bracket for frame and mullion	50 adet/pieces
	700 687	ORTA SIZDIRMAZLIK CONTASI İÇİN KÖŞE VULKANİZE vulcanized corner for central gasket	50 adet/pieces
	700 688	DIŞ BİNİ CONTASI İÇİN KÖŞE VULKANİZE vulcanized corner for ext.overlap gasket	50 adet/pieces
	700 689	ÇİFT KANAT ADAPTÖR KAPAGI pvc cap plug for double sash adapter	50 çift/pair

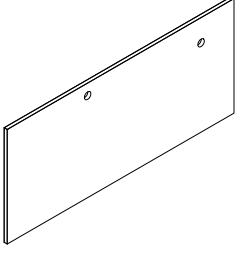
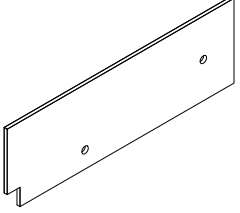
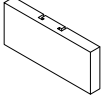
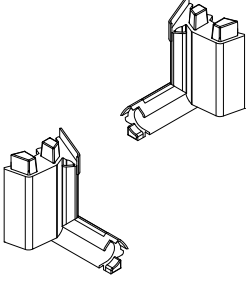
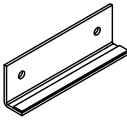
AKSESUAR ŞEKLİ ACCESSORIES SHAPE	AKSESUAR ACCESS. NO	AKSESUAR TANIMI ACCESSORIES DESCRIPTION	MİKTAR QUANTITY
	700 696	ETEK için PVC ENJEKSİYON pvc cap plug for door sill	20 çift/pair
	700 697	EŞİK için PVC ENJEKSİYON pvc cap plug for door threshold	20 çift/pair
	700 773	2mm GALVANİZLİ ANKRAJ 2mm galvanize strap anchor	20 adet/pieces
	700 776	ÇİFT KANAT ADAPTÖR KAPAGI pvc cap plug for double sash adapter	50 çift/pair
	700 841	DIŞ CAM CONTASI KÖŞE VULKANİZE vulcanized corner for exterior glazing gasket	50 adet/pieces
	700 716	DIŞ BİNİ KÖŞE VULKANİZE vulcanized corner for exterior overlap gasket	50 adet/pieces

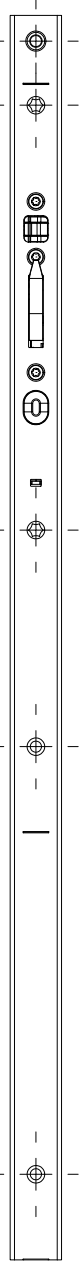
AKSESUAR ŞEKLİ ACCESSORIES SHAPE	AKSESUAR ACCESS. NO	AKSESUAR TANIMI ACCESSORIES DESCRIPTION	MİKTAR QUANTITY
	701 210	2mm ALU.BOYALI BİTİŞ KAPAGI 2mm Thick Aluminum End Dam	50 adet/pieces
	701 211	2mm ALU.BOYALI BİTİŞ KAPAGI 2mm Thick Aluminum End Dam	50 adet/pieces
	701 207	KASA ve ORTA KAYIT BİRLEŞİM ANKRAJİ T connection bracket for frame and mullion	50 adet/pieces
	701 208	ORTA SIZDIRMAZLIK CONTASI İÇİN KÖŞE VULKANİZE vulcanized corner for central gasket	20 çift/pair
	701 209	VASİSTAS PENCERE DIŞ CAM TAŞIYICI Glass support for top hung window	50 adet/pieces

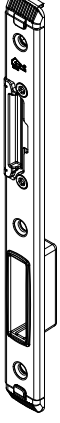
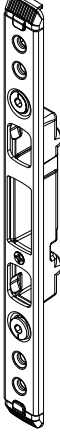
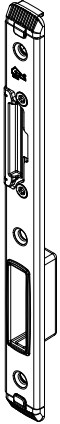

AKSESUAR ŐEKLİ ACCESSORIES SHAPE	AKSESUAR ACCESS. NO	AKSESUAR TANIMI ACCESSORIES DESCRIPTION
	VMV4U58010N	<p><b>KİLİT UZATMA PARÇASI</b> yüksek kapılar için</p> <p><b>ADDITIONAL LOCKING DEVICE</b> use for height door</p>
	VMF--2AP8NJ	<p><b>ÇOK NOKTADAN KİLİT AKSESUARI</b> L:1990mm</p> <p><b>MULTIPOINT LOCKING DEVICE</b> L:1990mm</p>

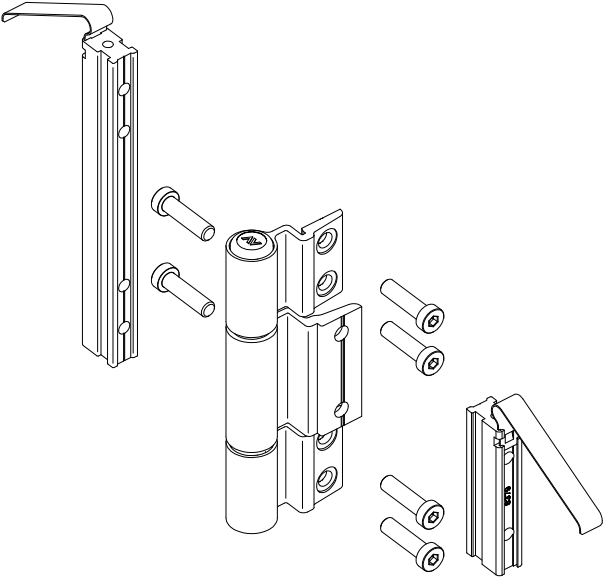
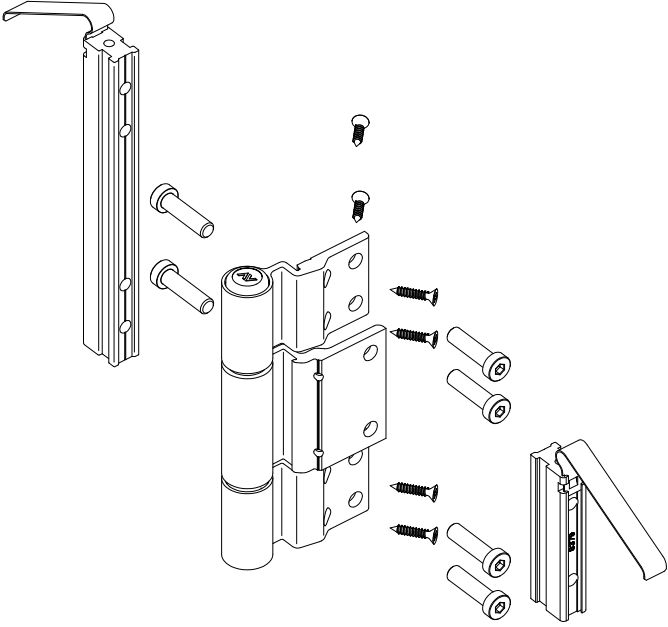
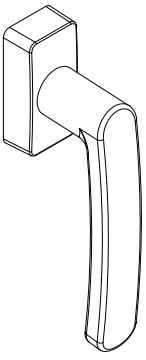
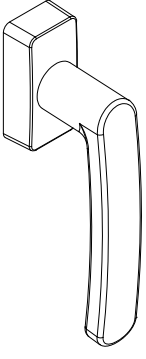
AKSESUAR ŐEKLİ ACCESSORIES SHAPE	AKSESUAR ACCESS. NO	AKSESUAR TANIMI ACCESSORIES DESCRIPTION
	VRNFP58684R1	<b>KİLİT KARŐILIGI (sağ)</b> kilit göbeđi için kullanılır  <b>KEEPER (right)</b> use with locking device body
	VRNJV58694Z	<b>KİLİT KARŐILIGI</b> alt ve üsteki diller için kullanılır  <b>KEEPER</b> use for top and bottom additional locking point
	VRNFP58684L1	<b>KİLİT KARŐILIGI (sol)</b> kilit göbeđi için kullanılır  <b>KEEPER (left)</b> use with locking device body

AKSESUAR ŞEKLİ ACCESSORIES SHAPE	AKSESUAR ACCESS. NO	AKSESUAR TANIMI ACCESSORIES DESCRIPTION
	1143.35	<b>İÇE AÇILIR KAPI SİLİNDİR MENTEŞE</b> standart renkler : gümüş,beyaz,siyah (2Adet = 100kg) (3Adet = 120kg)  <b>CYLINDER HINGES</b> for INWARD OPENING DOOR standart colours : silver,white,black (2pieces = 100kg) (3pieces = 120kg)
	1143.36	<b>DIŞA AÇILIR KAPI SİLİNDİR MENTEŞE</b> standart renkler : gümüş,beyaz,siyah (2Adet = 100kg) (3Adet = 120kg)  <b>CYLINDER HINGES</b> for OUTWARD OPENING DOOR standart colours : silver,white,black (2pieces = 100kg) (3pieces = 120kg)
	700 830	<b>140mm DÜZ KOL (90° stoplu)</b> (Standart Renk : siyah) (Tüm Ral renkleri - min sipariş : 1000ad) <b>140mm FLAT HANDLE (90° stoplu)</b> (Standart Color : black) (All Ral Colors - min quantity : 1000piece)
	700 831	<b>180mm DÜZ KOL (90° stoplu)</b> (Standart Renk : siyah) (Tüm Ral renkleri - min sipariş : 1000ad) <b>180mm FLAT HANDLE (90° stoplu)</b> (Standart Color : black) (All Ral Colors - min quantity : 1000piece)

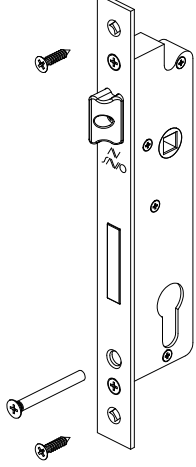
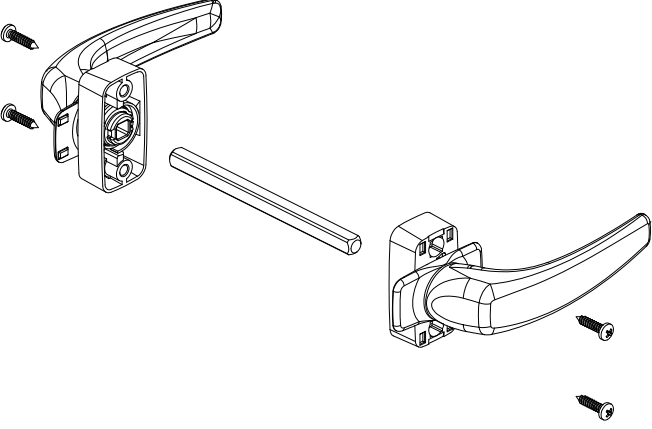
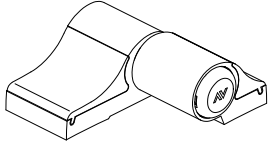
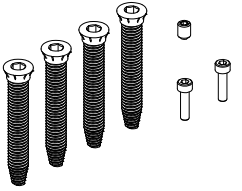

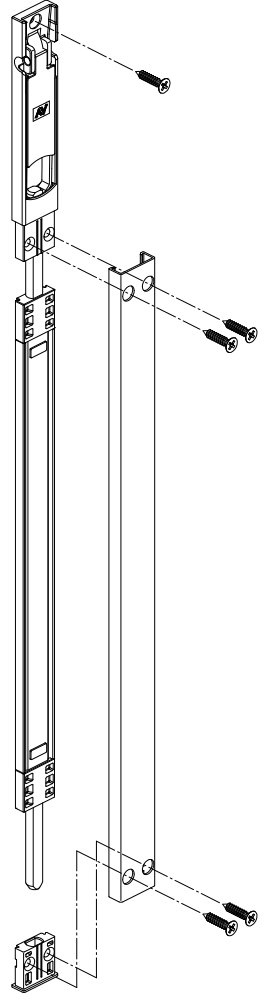
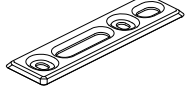
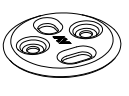
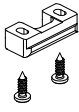

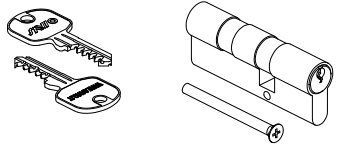
AKSESUAR ŞEKLİ ACCESSORIES SHAPE	AKSESUAR ACCESS. NO	AKSESUAR TANIMI ACCESSORIES DESCRIPTION
	1852.19 / 30G	<b>DİLLİ KİLİT GÖBEGİ</b> locking device body
	866.31	<b>ARIANNA - BASMA KOL</b> arianna - manuel handle
	1146 / 62,5	<b>İÇE-DIŞA AÇILIR KAPI KAPAZLAMA MENTEŞE</b> standart renkler : gümüş,beyaz,siyah özel renk,eloxal (2Adet = 160kg) (3Adet = 180kg)  <b>SURFACE MOUNTING HINGES</b> for <b>OUTWARD-INWARD OPENING DOOR</b> standart colours : silver,white,black special color,anodise (2pieces = 160kg) (3pieces = 180kg)
	1145 / 745	<b>KAPAZLAMA MENTEŞE VİDA SETİ</b> face mounting hinges screw set

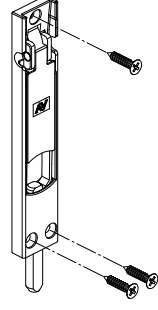
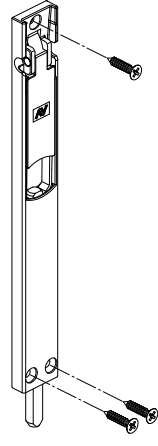
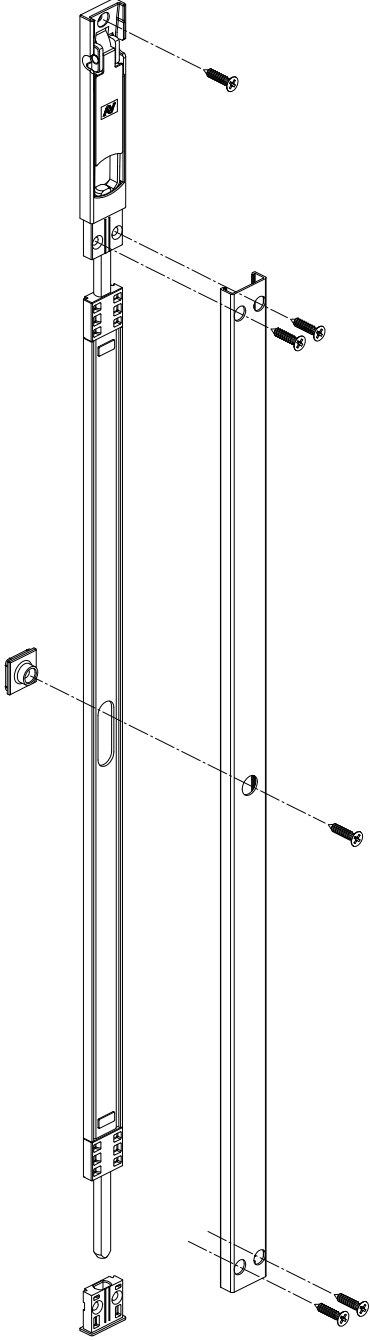
AKSESUAR ŞEKLİ ACCESSORIES SHAPE	AKSESUAR ACCESS. NO	AKSESUAR TANIMI ACCESSORIES DESCRIPTION
	1557 / 45	45cm FİŞEK SÜRGÜ standart renkler : silver,beyaz,siyah
	1408.1	FİŞEK SÜRGÜ ALT KARŞILIGI bottom keeper for sliding bar locking device
	1408	FİŞEK SÜRGÜ ALT KARŞILIGI bottom keeper for sliding bar locking device
	1411.1	FİŞEK SÜRGÜ ÜST KARŞILIGI top keeper for sliding bar locking device
	1409 / 8	FİŞEK SÜRGÜ ALT KARŞILIGI bottom keeper for sliding bar locking device
	1852.801 / 85	BAREL SETİ cylinder locking set

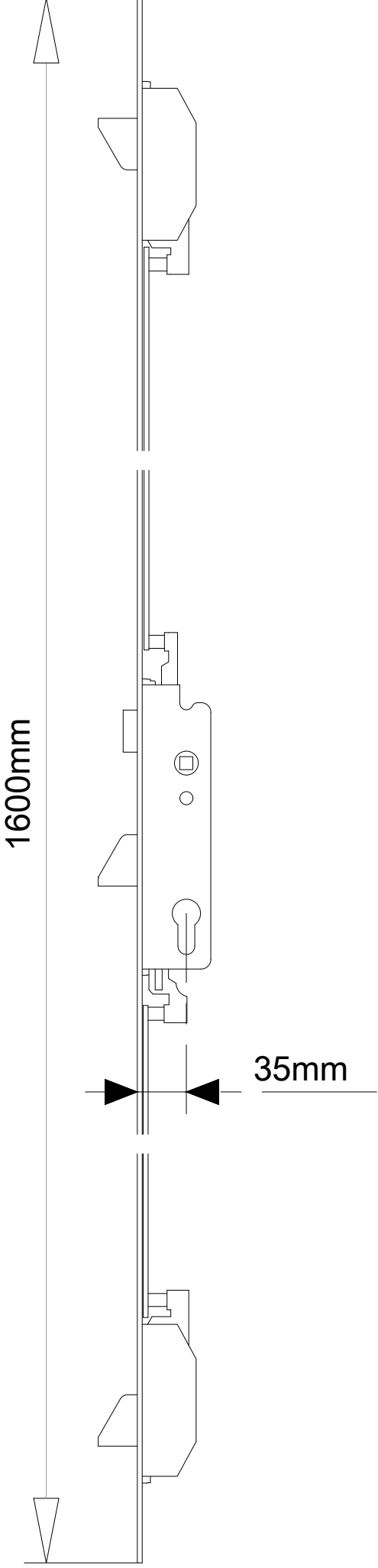
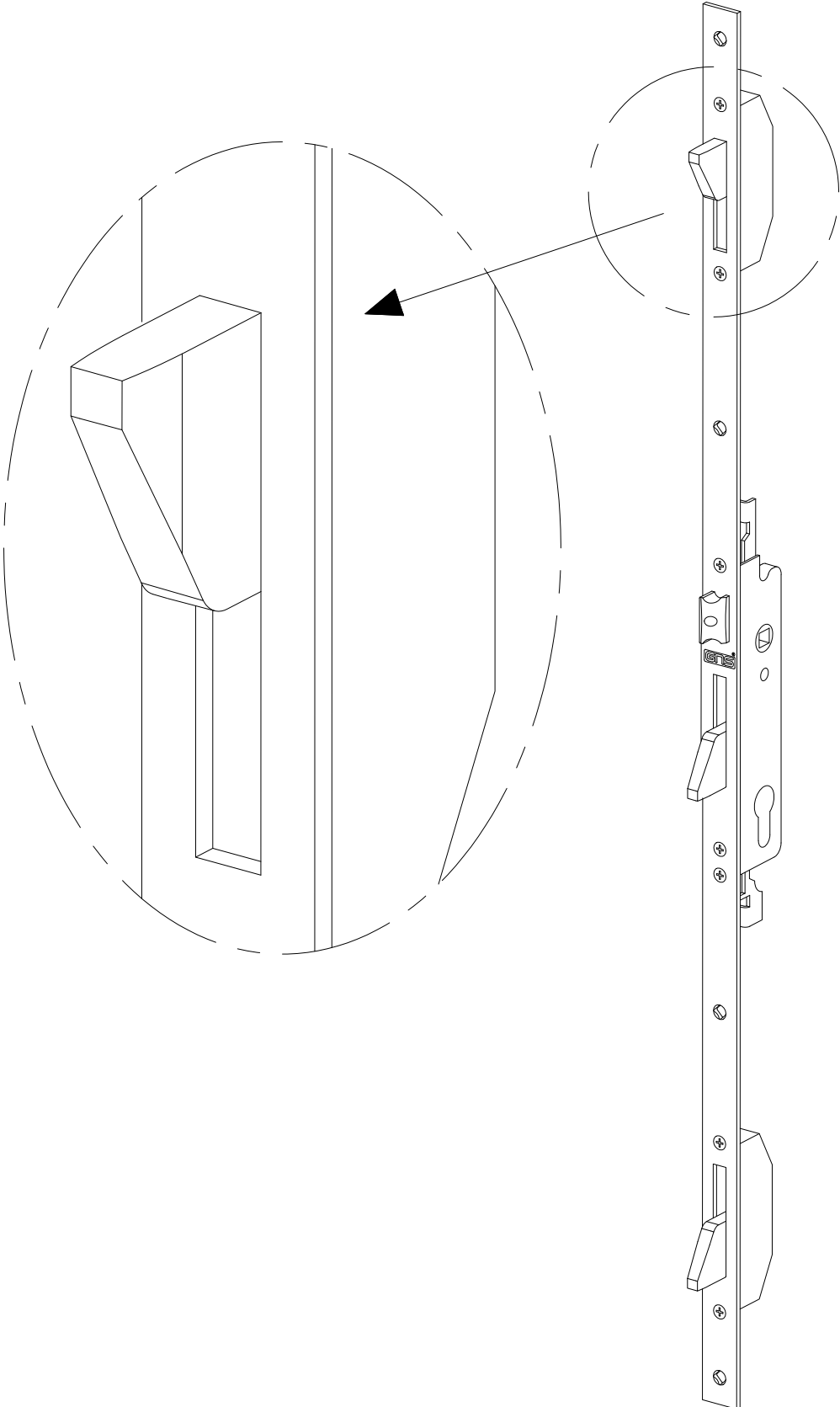
AKSESUAR ŞEKLİ ACCESSORIES SHAPE	AKSESUAR ACCESS. NO	AKSESUAR TANIMI ACCESSORIES DESCRIPTION
	1557 / 13	<b>13cm FİŞEK SÜRGÜ</b> standart renkler : gümüş,beyaz,siyah <b>13cm SLIDING BAR LOCKING DEVICE</b> standart colours : silver,white,black
	1557 / 20	<b>20cm FİŞEK SÜRGÜ</b> standart renkler : gümüş,beyaz,siyah <b>20cm SLIDING BAR LOCKING DEVICE</b> standart colours : silver,white,black
	1557 / 65	<b>65cm FİŞEK SÜRGÜ</b> standart renkler : gümüş,beyaz,siyah <b>65cm SLIDING BAR LOCKING DEVICE</b> standart colours : silver,white,black

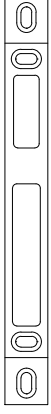
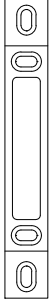
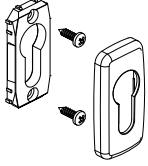
AKSESUAR ŐEKLİ ACCESSORIES SHAPE	AKSESUAR ACCESS. NO	AKSESUAR TANIMI ACCESSORIES DESCRIPTION
 <p>1600mm</p> <p>35mm</p>	<p>7717 TU X35</p>	<p><b>ÇOK NOKTADAN KİLİTLEME İSPANYOLET</b> uzunluk : 1600mm barel aksı :35mm <b>MULTIPOINT LOCKING DEVICE</b> length : 1600mm cylinder axe : 35mm</p> 

AKSESUAR ŞEKLİ ACCESSORIES SHAPE	AKSESUAR ACCESS. NO	AKSESUAR TANIMI ACCESSORIES DESCRIPTION
	CT 1	<b>KİLİT KARŞILIGI</b> kilit göbeği için kullanılır <b>KEEPER</b> use with locking device body
	CT 2	<b>KİLİT KARŞILIGI</b> alt ve üsteki diller için kullanılır <b>KEEPER</b> use for top and bottom additional locking point
	874.804	<b>BAREL KAPAK SETİ</b> standart renkler : gümüş,beyaz,siyah <b>PVC CAP PLUG for CYLINDER</b> standart colours : silver,white,black
	WU1R 1B-2A-3A OA0440 SA0355-A-0	<b>GIZLI MENTEŞE</b> concealed hinge



**Spectral90**  
**KATLAR ARASI DOGRAMA SİSTEMİ**  
WINDOW WALL SYSTEM

**TAM ÖLÇEKLİ PROFİLLER**  
FULL SCALE PROFILES

**P 2525**

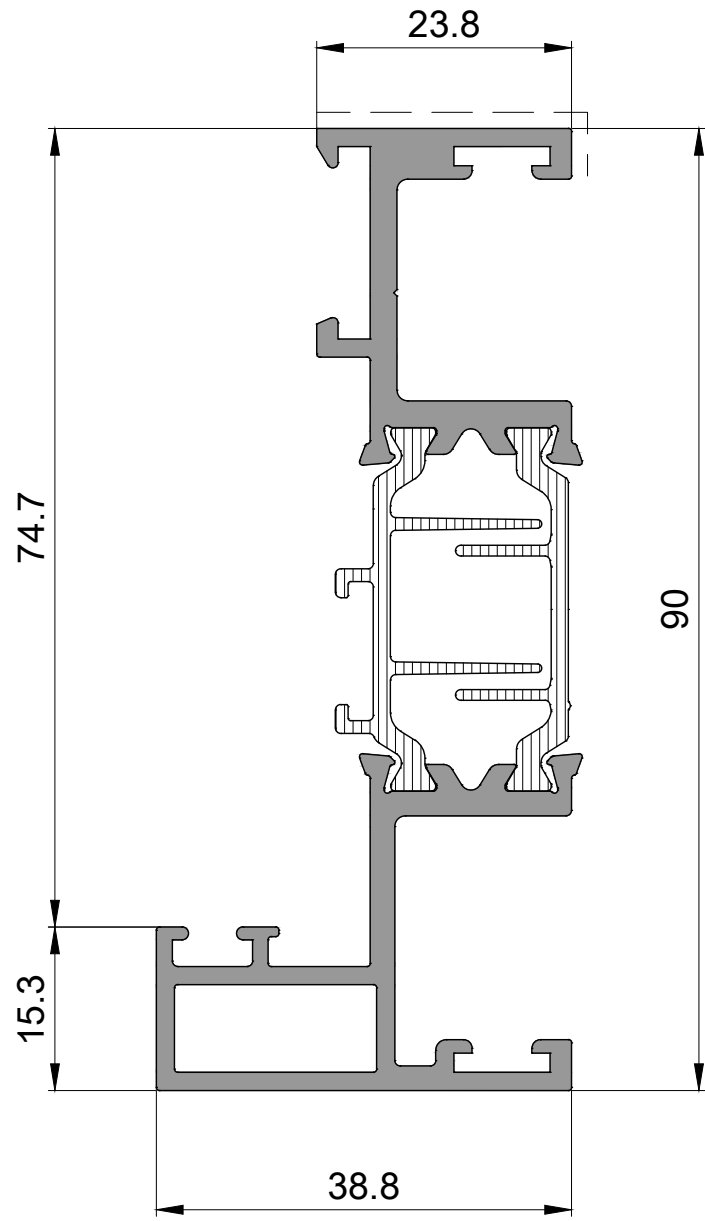
Dişi Düşey Profil / Female Mullion  
1,575kg/mt





$I_x$   39.12 cm<sup>4</sup>     
  $I_y$   4.05 cm<sup>4</sup>

**P 2526**

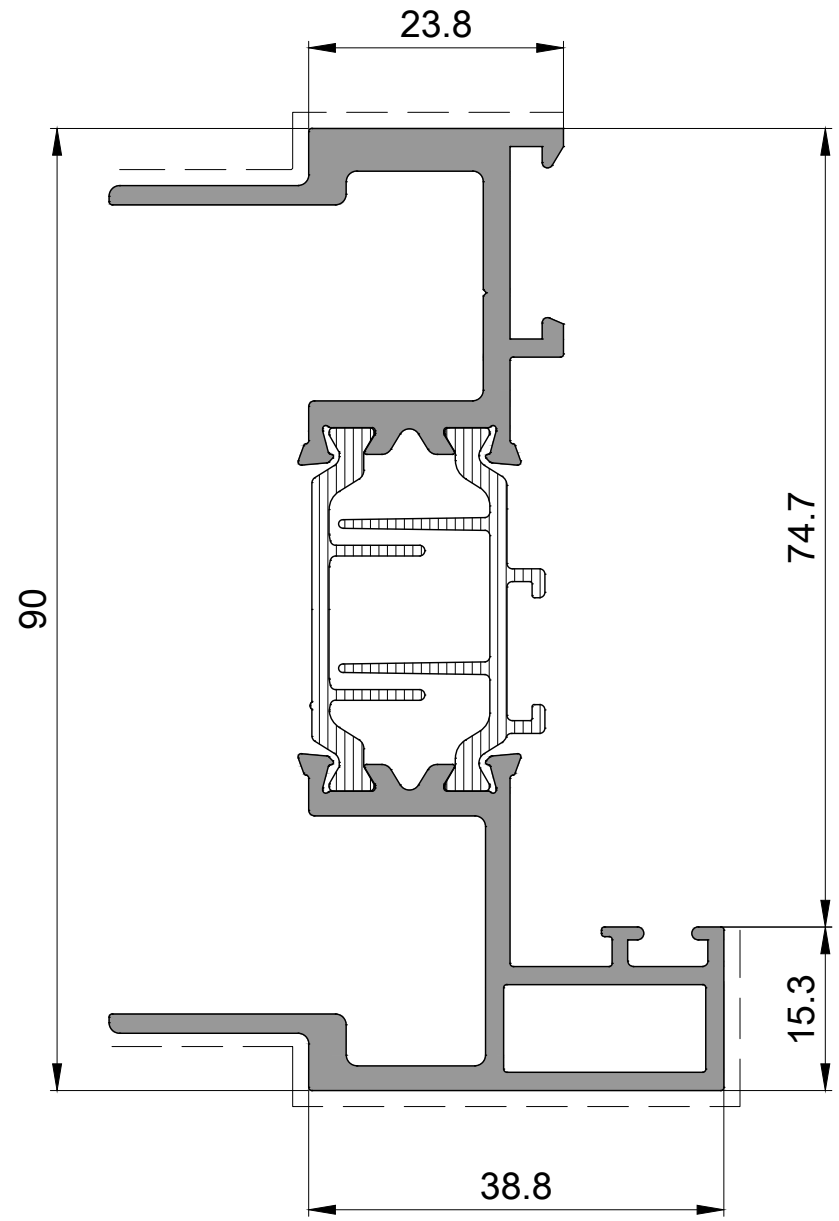
Erkek Düşey Profil / Male Mullion  
1,845kg/mt



$I_x$   51.21 cm<sup>4</sup>     
  $I_y$   8.26 cm<sup>4</sup>

**P 2527**

Yan Düşey Profil / Side Mullion  
1,455kg/mt

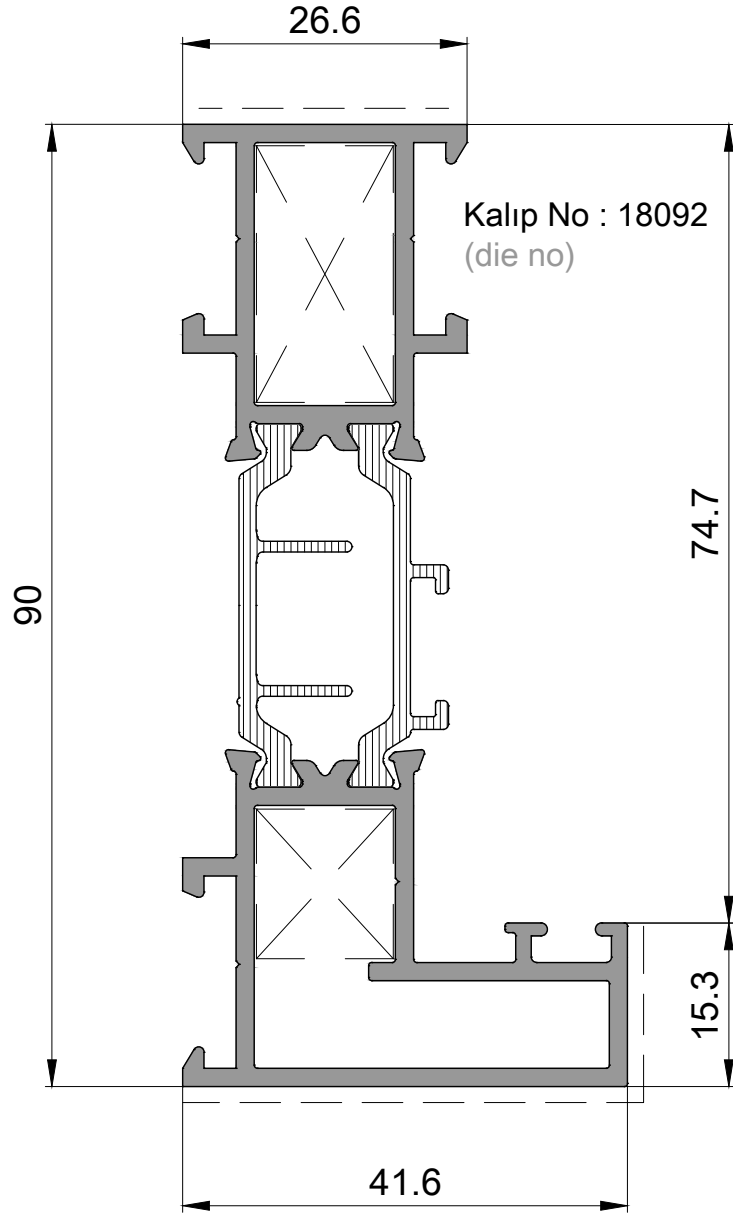

lx )  
38.64 cm<sup>4</sup>

ly )  
5.36 cm<sup>4</sup>

**P 2528**

Yatay Profil / Transom Profile  
1,860kg/mt

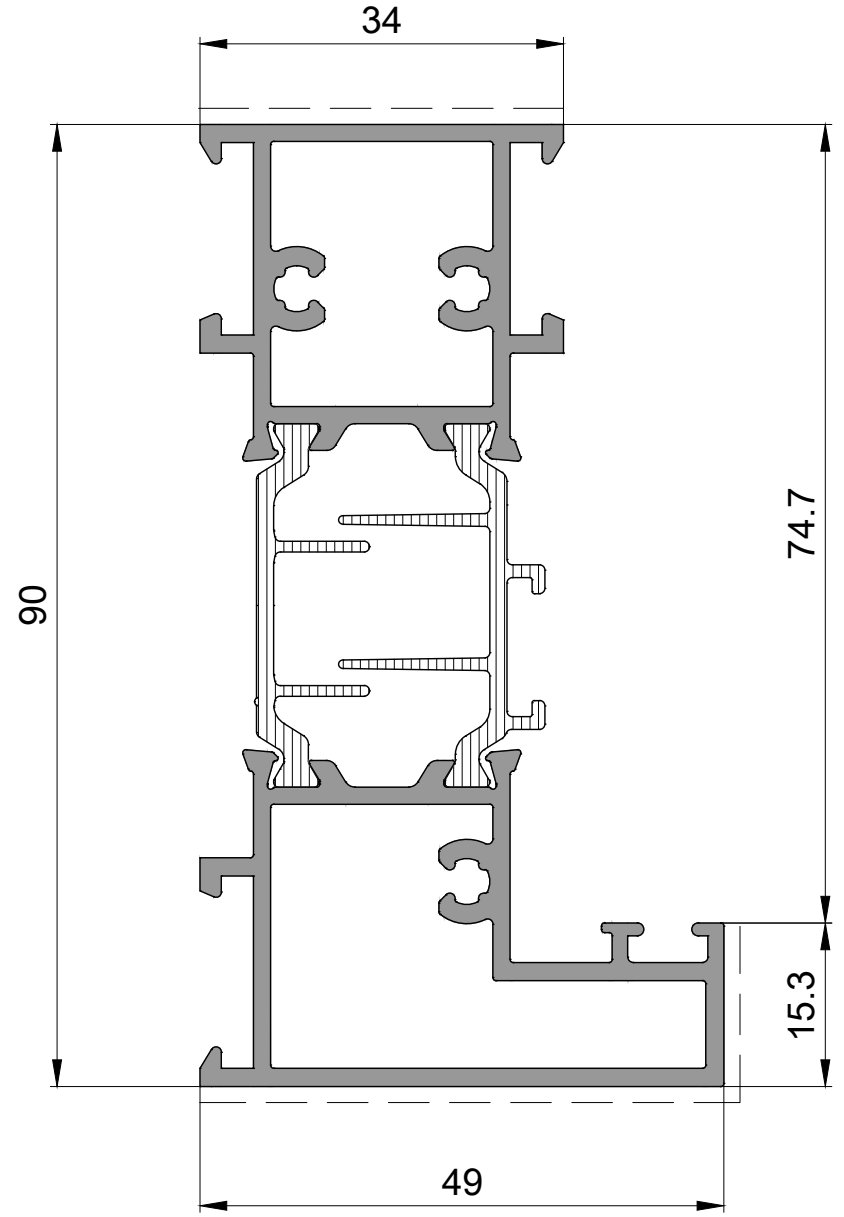

lx )  
46.41 cm<sup>4</sup>

ly )  
9.34 cm<sup>4</sup>



**P 1715**

Reseptor Çıta Profili / Receptor Slat Profile  
0,570kg/mt

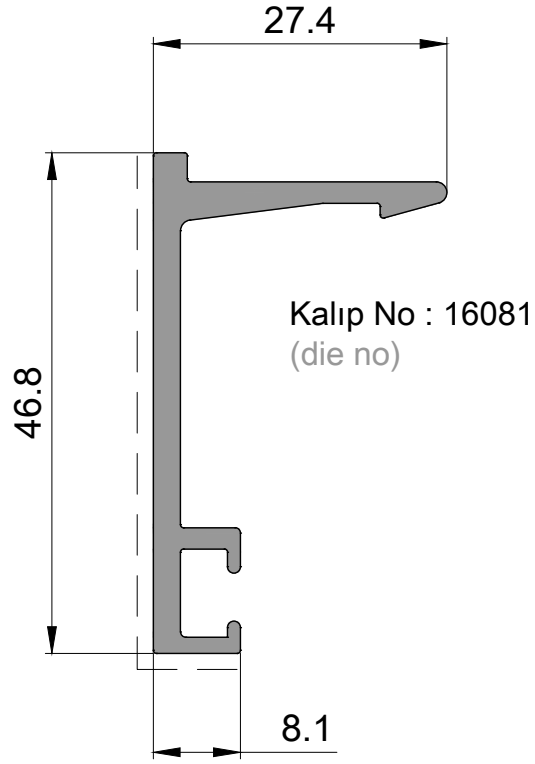

**P 2520**

Alt Receptor Ek Profil / Additional Profile for Bottom Receptor  
0,390kg/mt

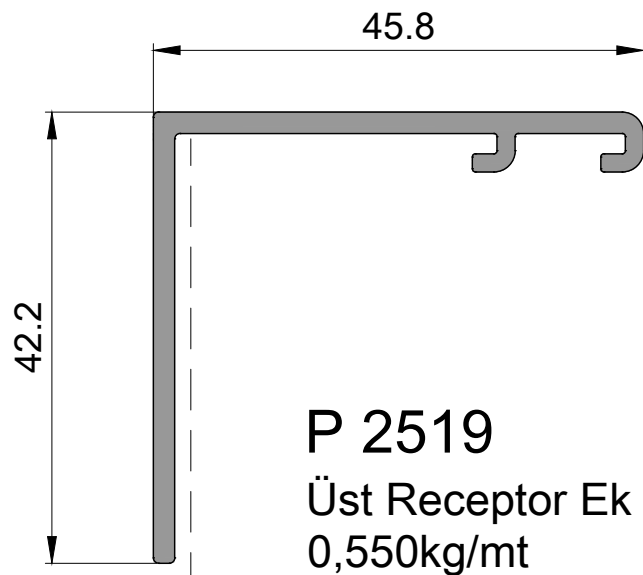
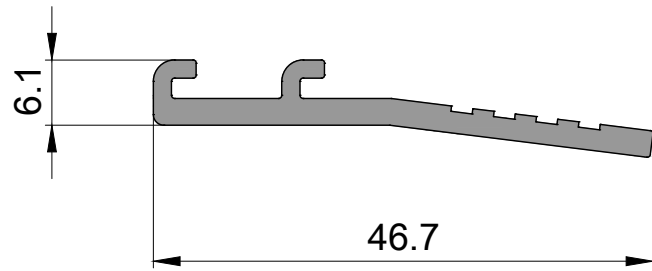

**P 2529**

Üst Receptor Profili / Top Receptor Profile  
1,820kg/mt

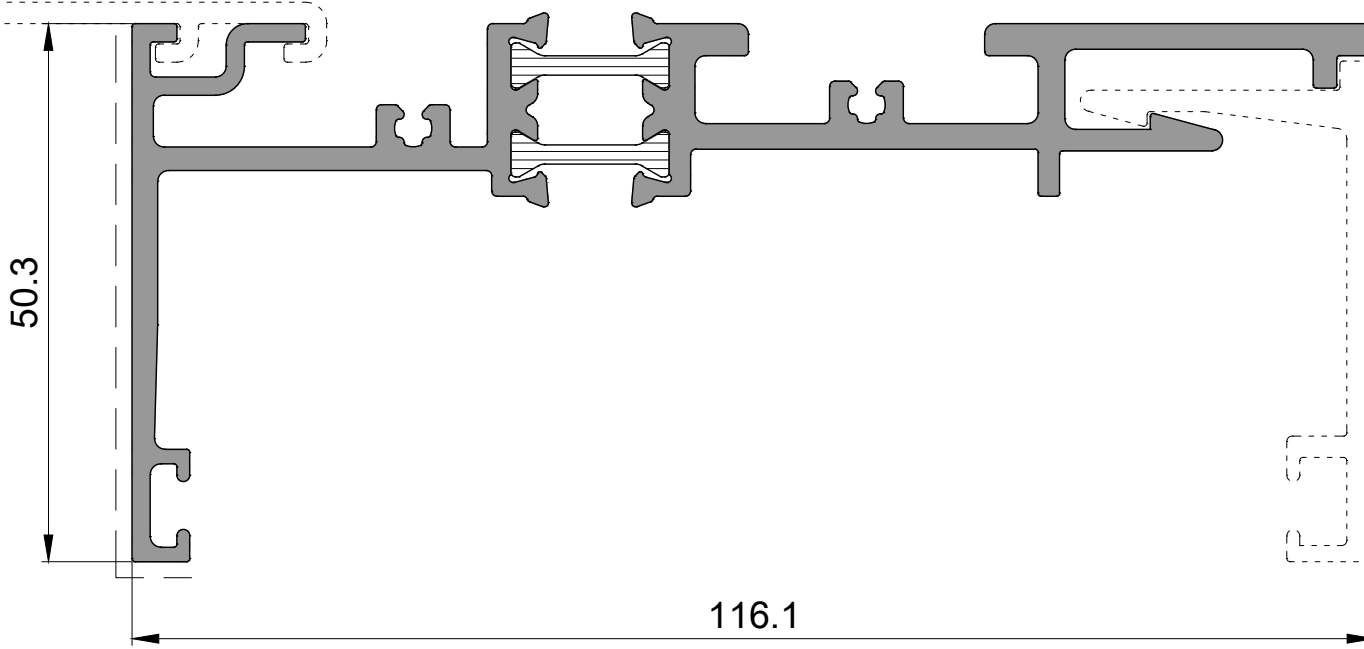

**P 2530**

Alt Receptor Profili / Bottom Receptor Profile  
2,170kg/mt

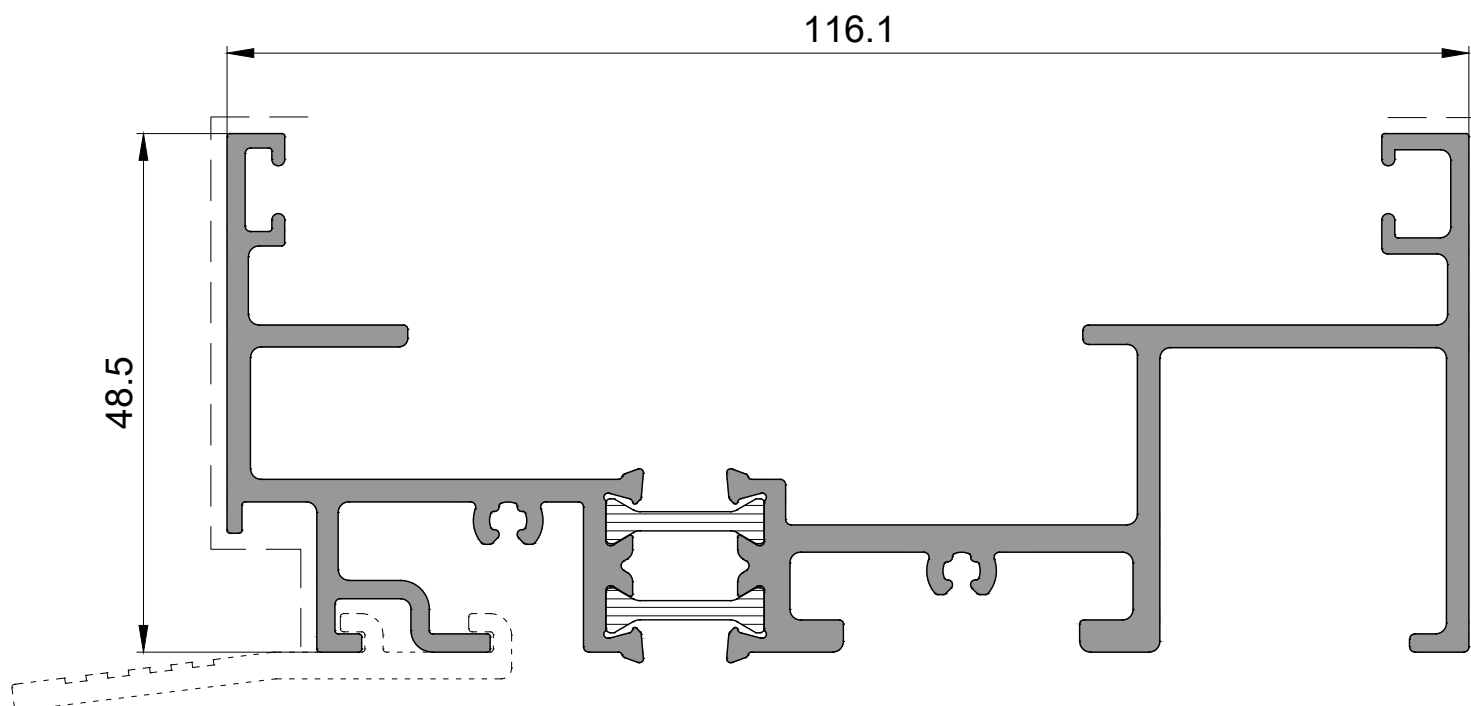

**P 2193**

Kasa Profili / Frame Profile  
1,770kg/mt

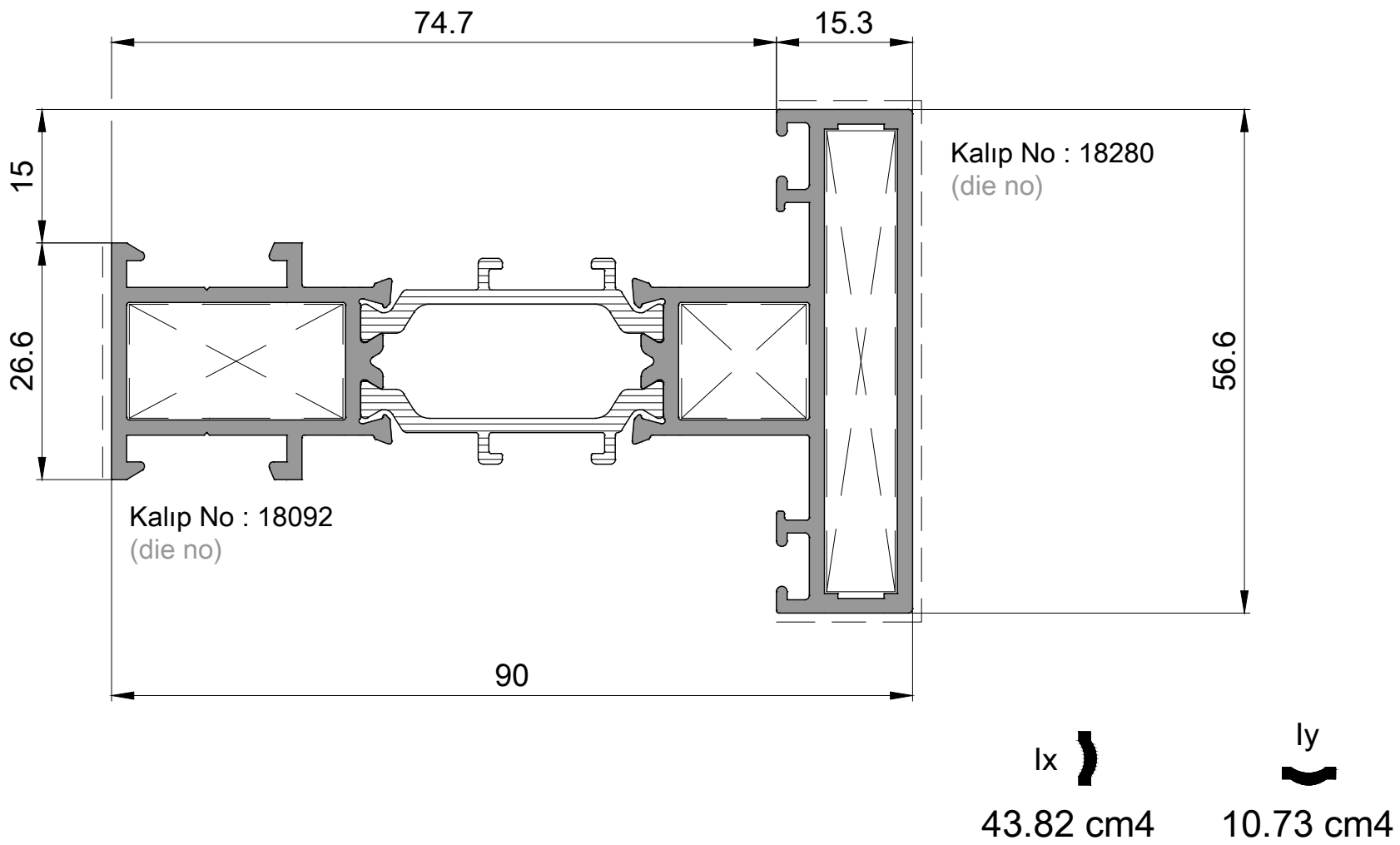

**P 2409**

Kanat Profili / Sash Profile  
1,460kg/mt

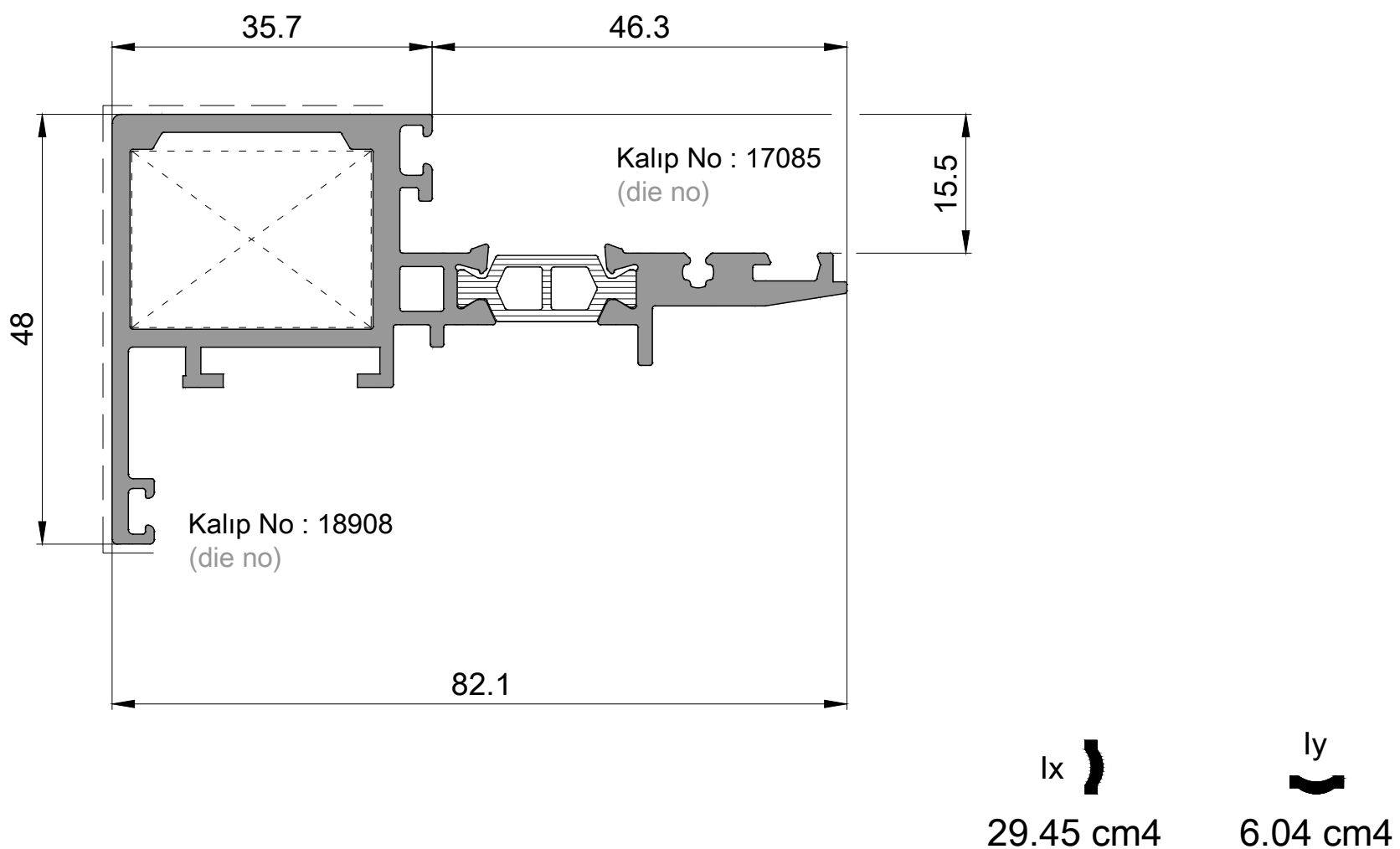

**P 2408**  
Adaptör Profili / Adepter Profile  
2,685kg/mt

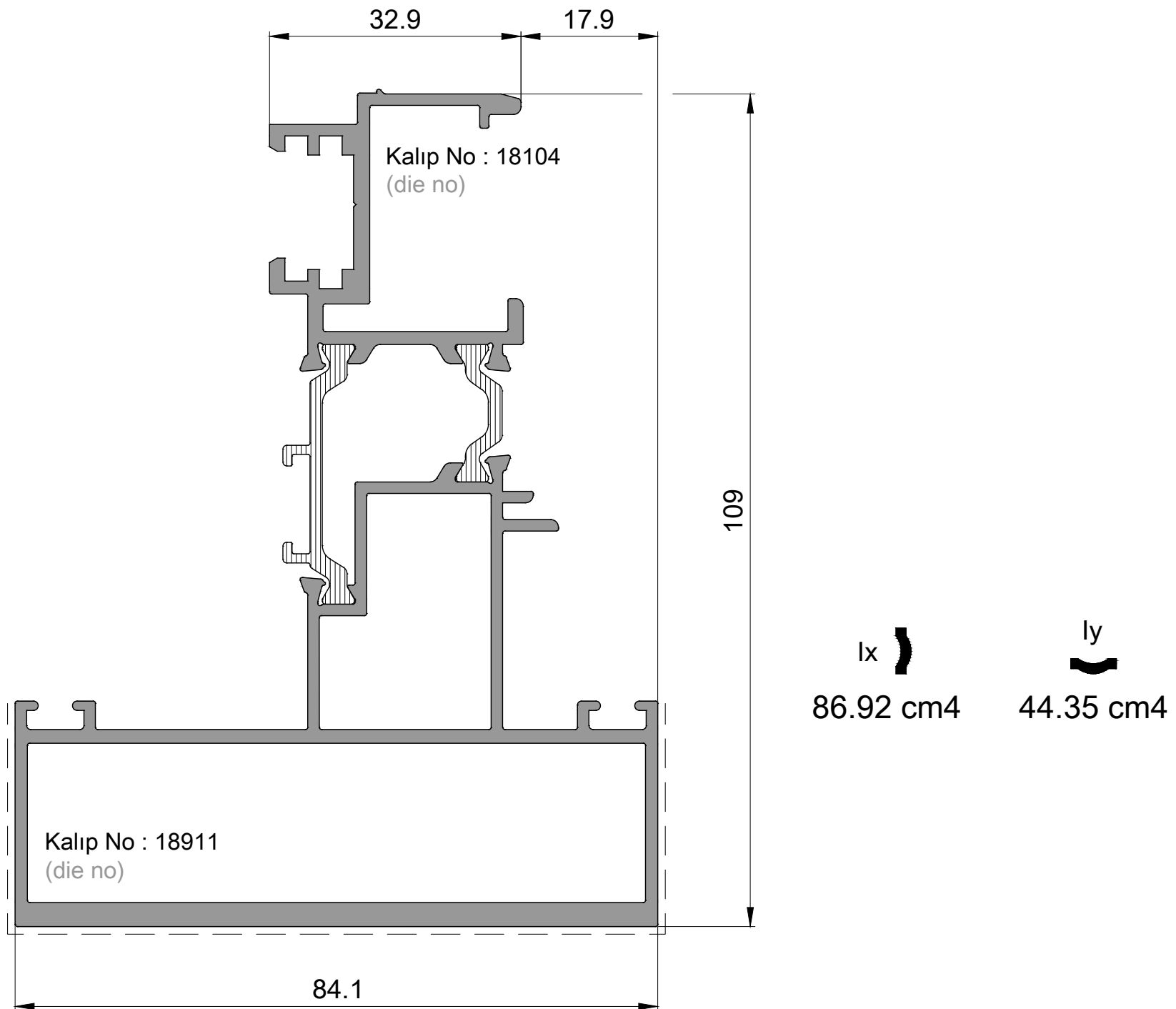

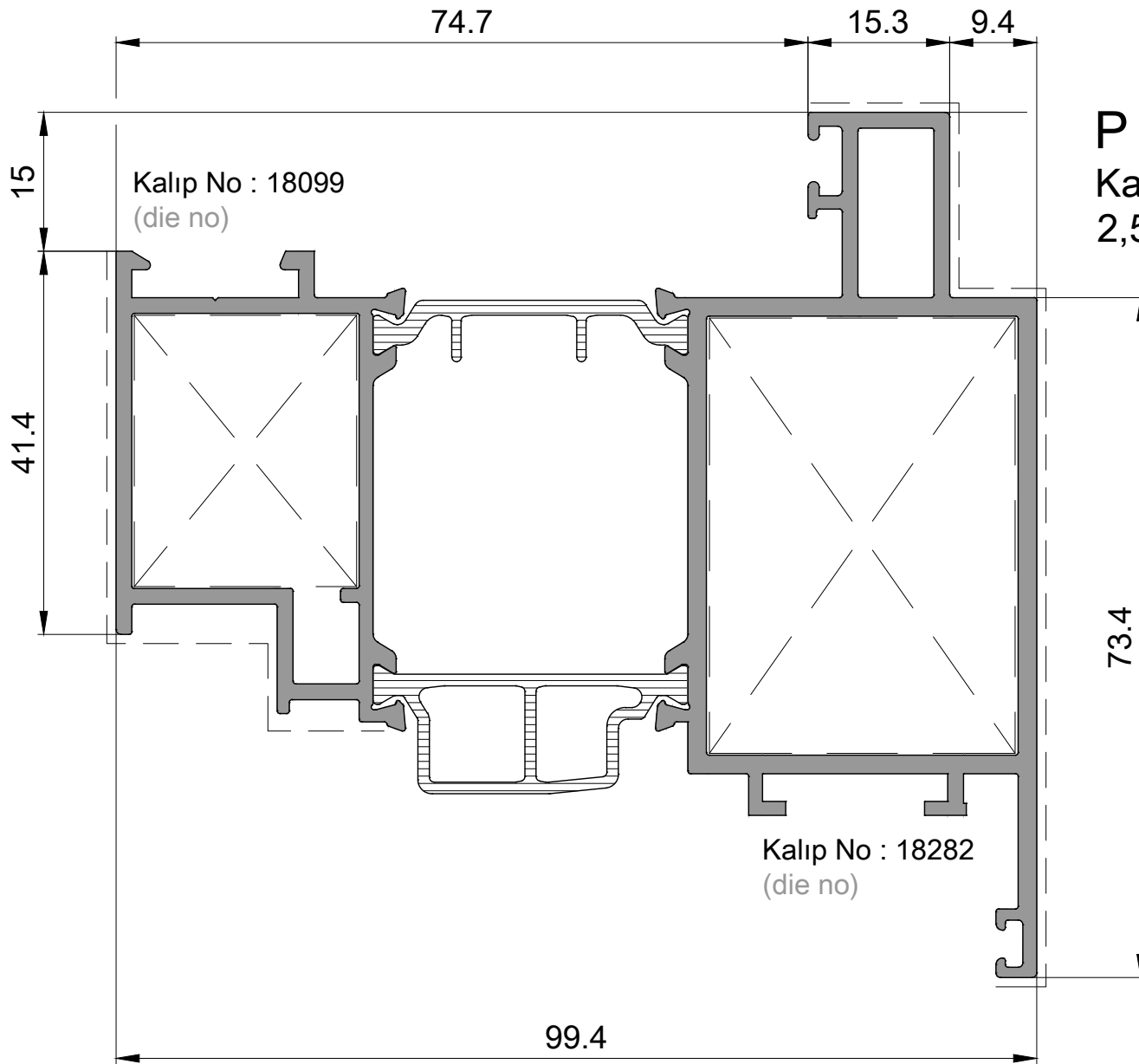

**P 2194**  
Kanat Profili / Sash Profile  
2,500kg/mt

ix ) 72.17 cm<sup>4</sup>      ly ) 43.01 cm<sup>4</sup>

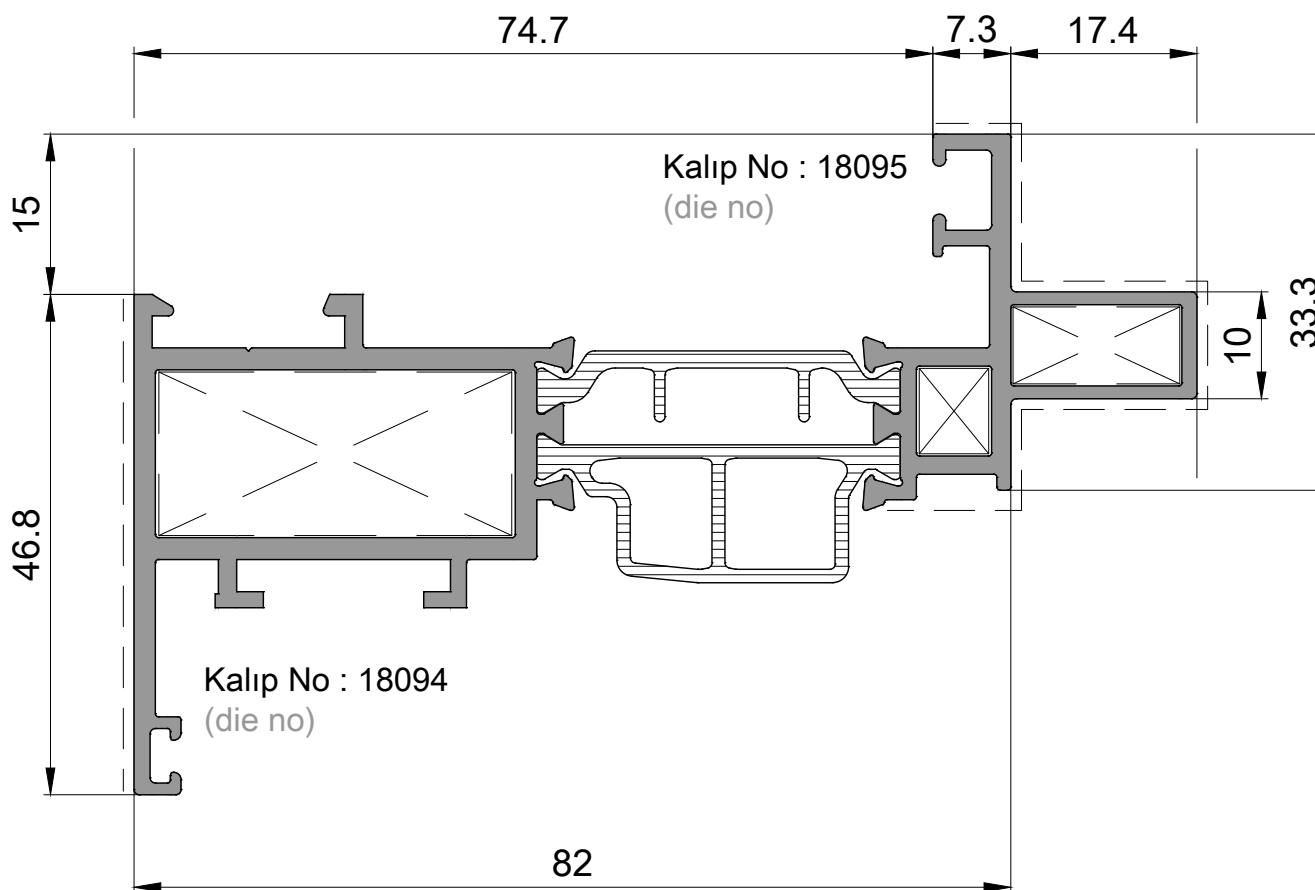

**P 2176**  
Kanat Profili / Sash Profile  
1,720kg/mt

ix ) 46.50 cm<sup>4</sup>      ly ) 5.32 cm<sup>4</sup>

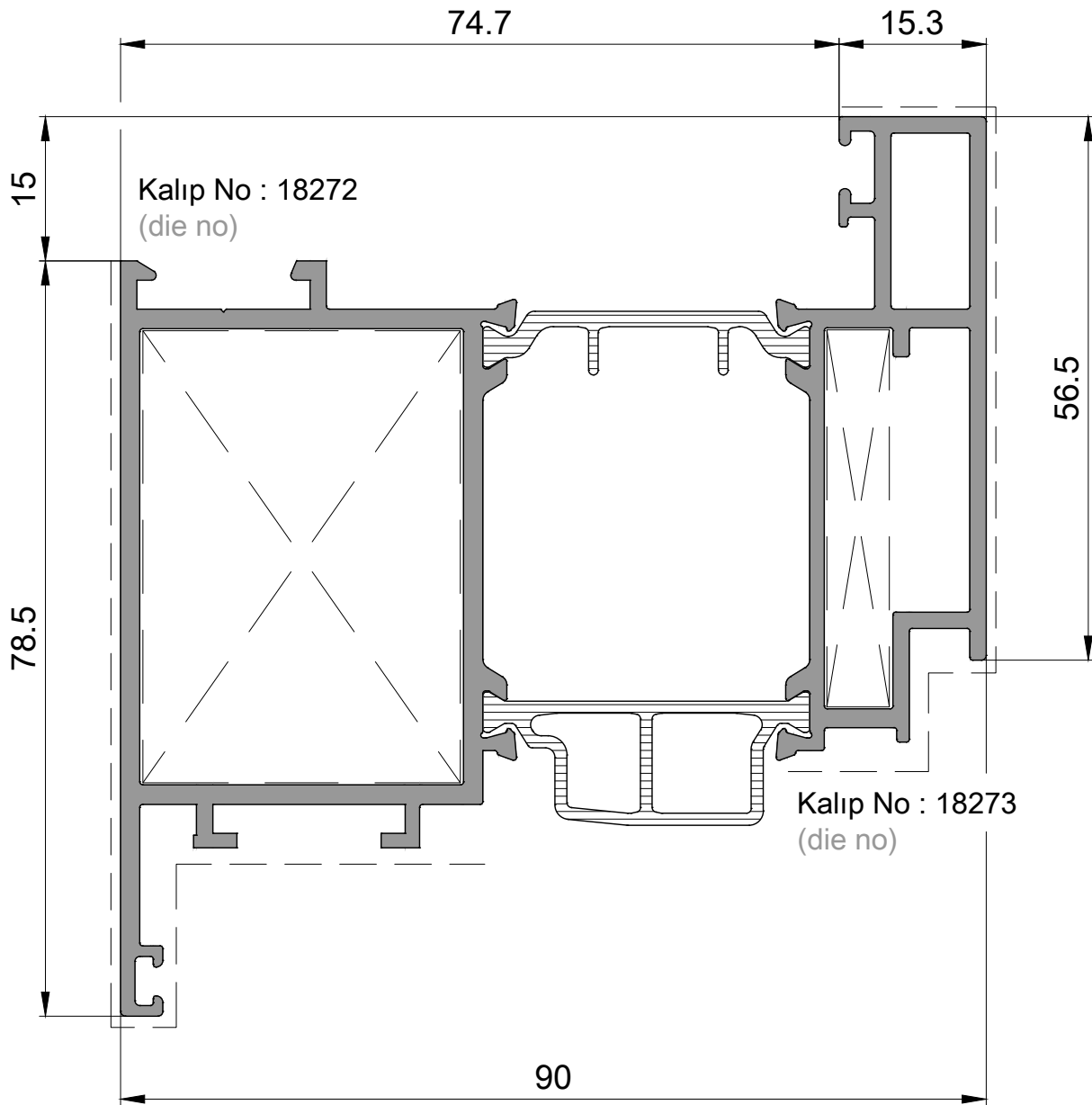

**P 2196**  
Kanat Profili / Sash Profile  
2,445kg/mt

ix  75.31 cm<sup>4</sup>      ly  32.79 cm<sup>4</sup>

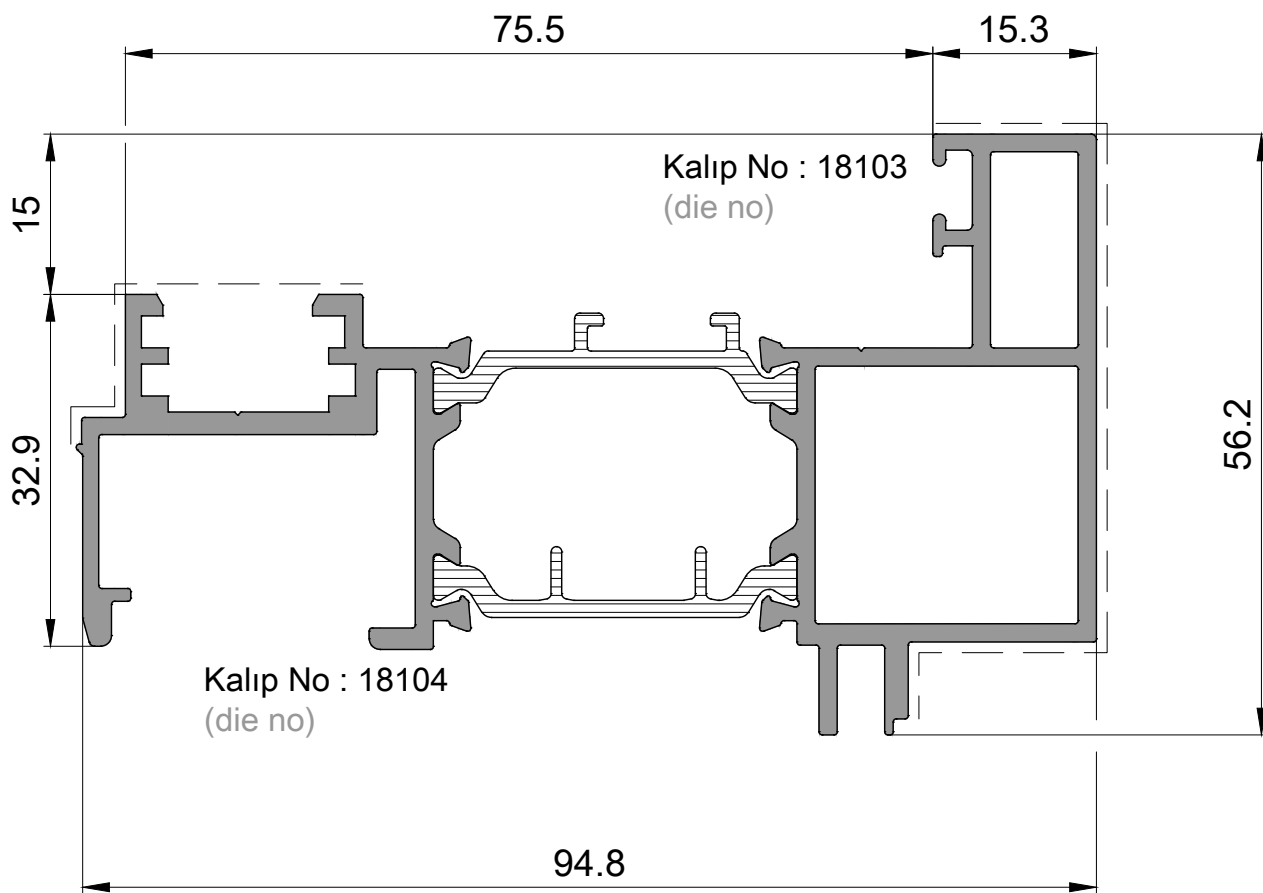

**P 2179**  
Adaptör Profili / Adepter Profile  
1,795kg/mt

ix  45.90 cm<sup>4</sup>      ly  10.84 cm<sup>4</sup>

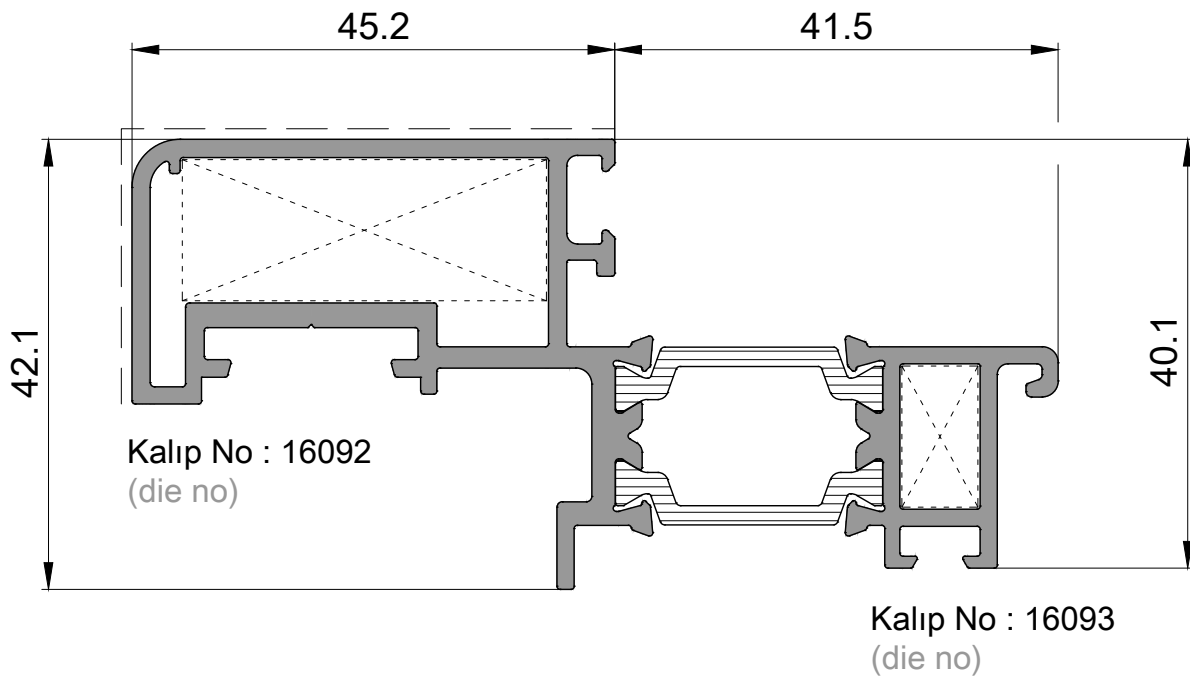

**P 2508**  
Kanat Profili / Sash Profile  
1,490kg/mt

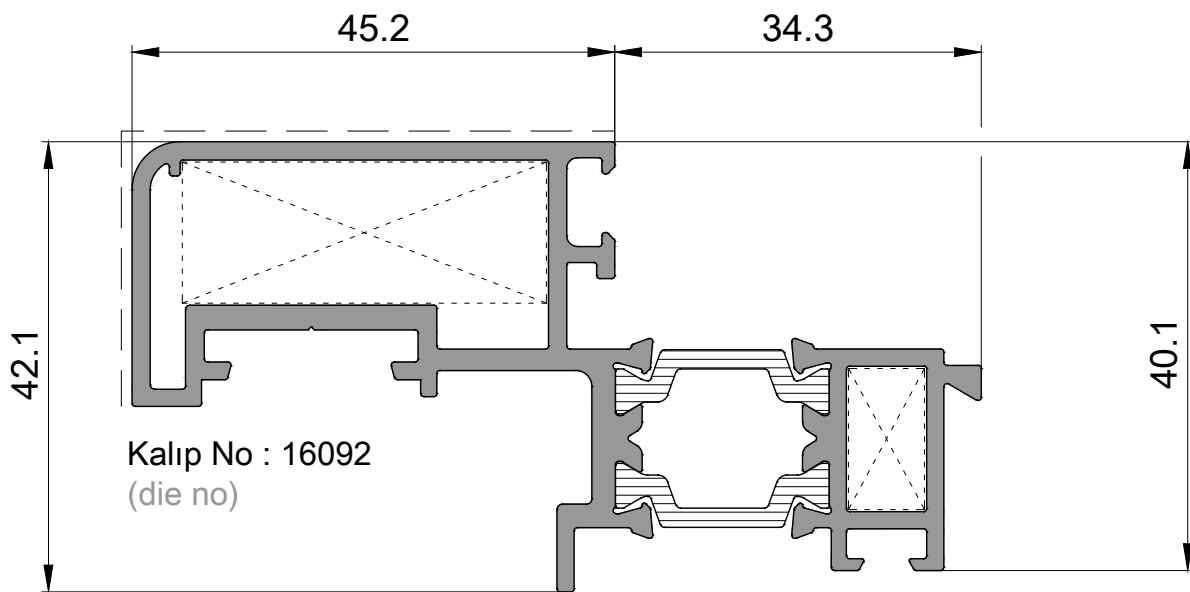

**P 2509**  
Kanat Profili / Sash Profile  
1,450kg/mt

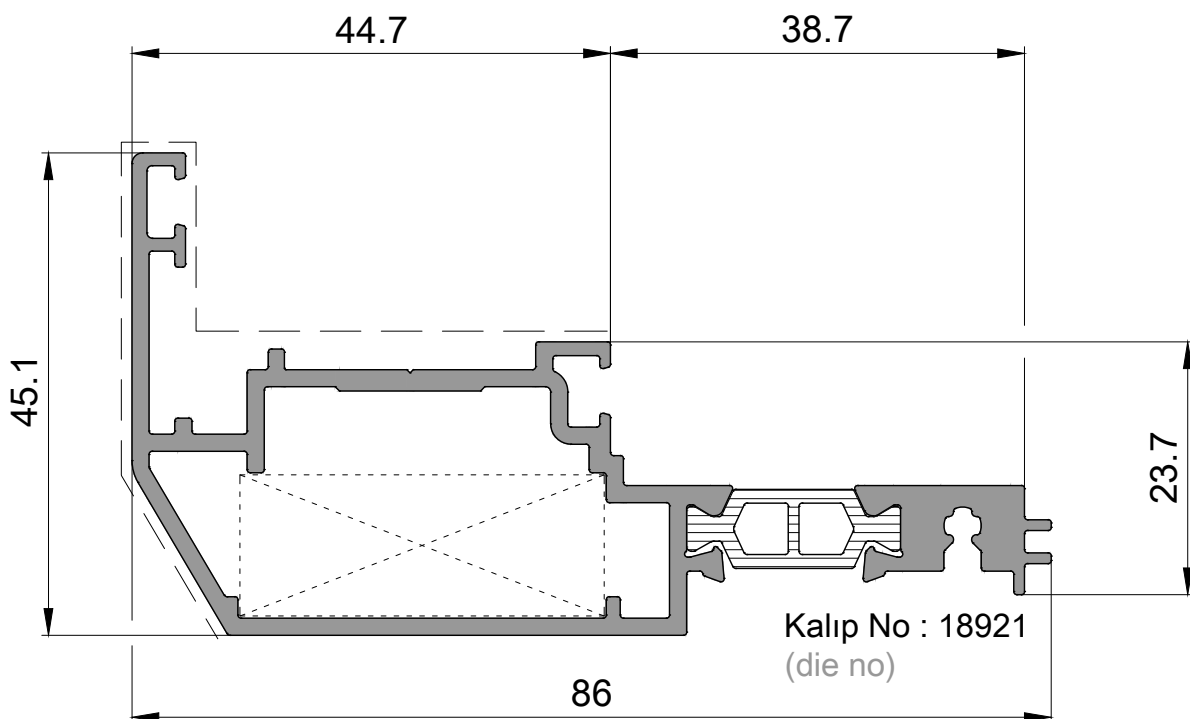

**P 2510**  
Kasa Profili / Frame Profile  
1,245kg/mt

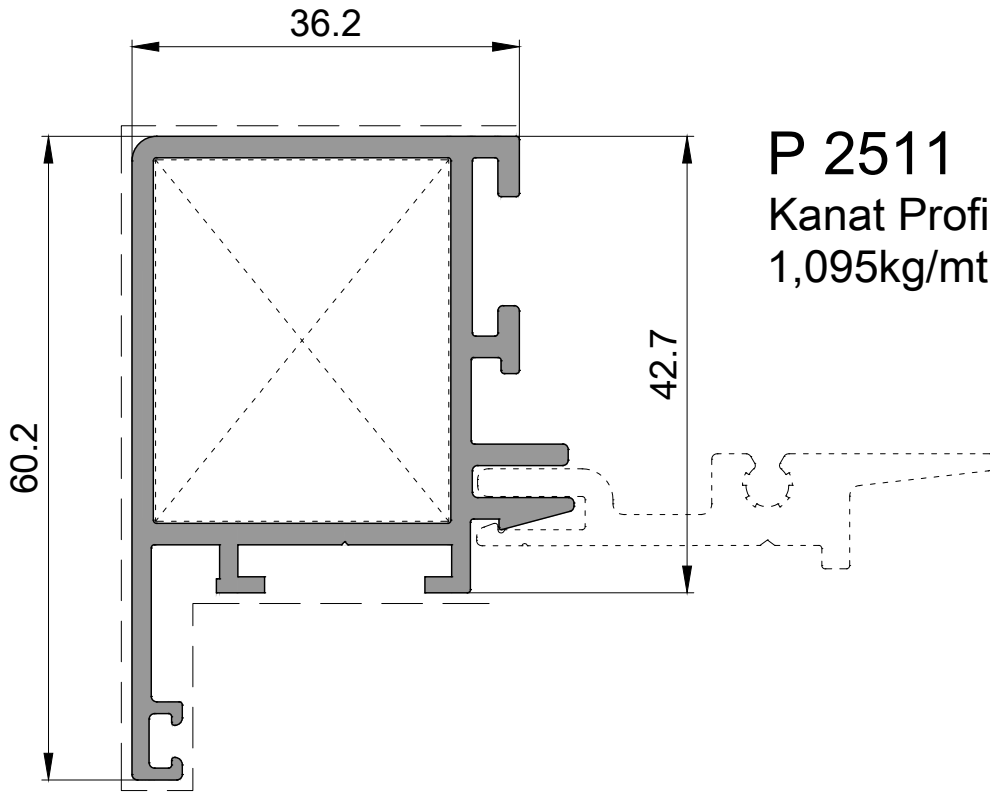

**P 2511**  
Kanat Profili / Sash Profile  
1,095kg/mt

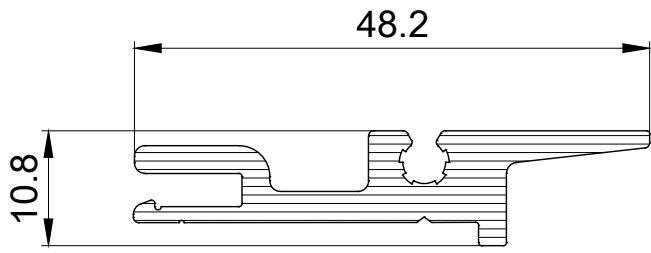

**600 505**  
Polyamid Çıta Profili / Polyamide Slate Profile  
0,280kg/mt

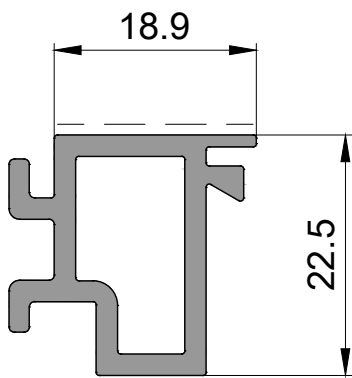

**P 2513**  
Adaptor Profili / Adepter Profile  
0,470kg/mt

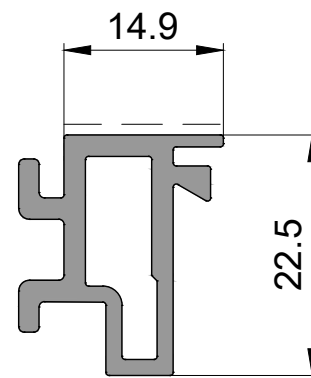

**P 2514**  
Adaptor Profili / Adepter Profile  
0,400kg/mt



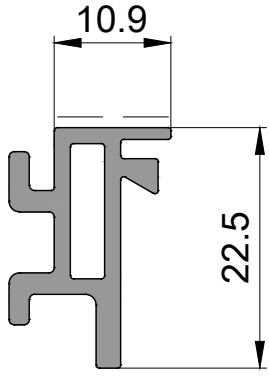

**P 2515**  
Adaptor Profili / Adepter Profile  
0,320kg/mt

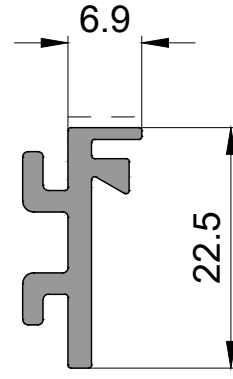

**P 2516**  
Adaptor Profili / Adepter Profile  
0,250kg/mt

**P 1699**  
Cam Çıta Profili / Glazing Bead Profile  
0,300kg/mt

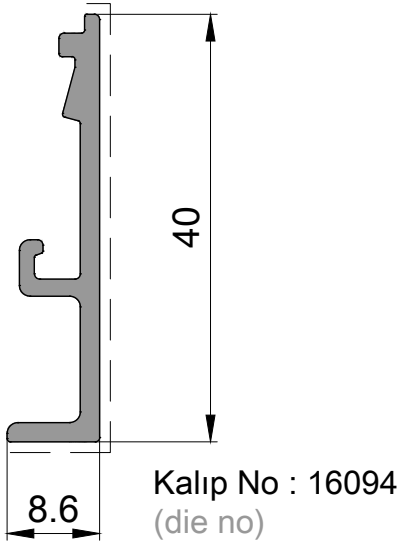

**P 1647**  
Çıta Profili / glazing bead profile  
0,275kg/mt

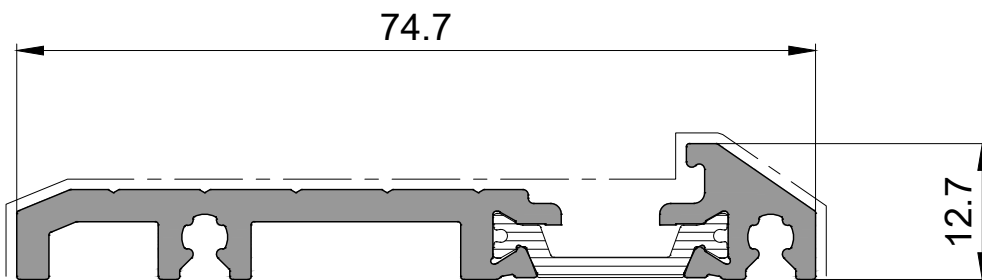
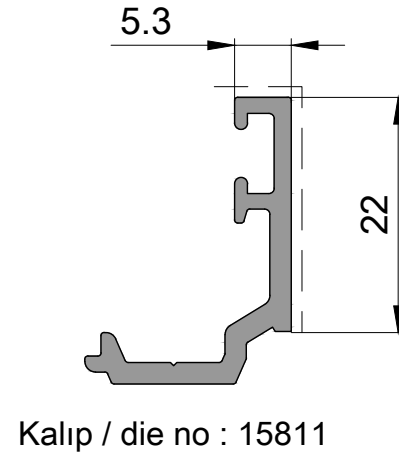

**P 2517**  
Eşik Profili / Threshold Profile  
0,880kg/mt

**P 2180**

Çıta Profili / glazing bead profile  
0,240kg/mt

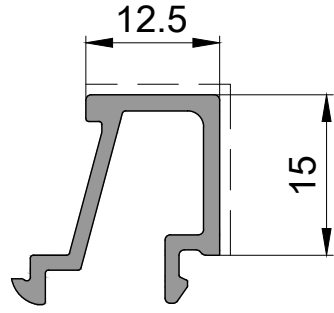

**P 2181**

Çıta Profili / glazing bead profile  
0,285kg/mt

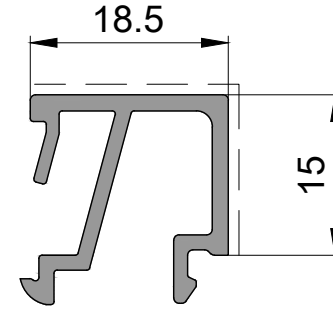

Kalıp / die no : 18279

**P 2182**

Çıta Profili / glazing bead profile  
0,295kg/mt

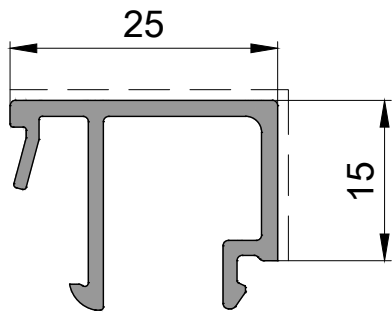

Kalıp / die no : 18096

**P 2183**

Çıta Profili / glazing bead profile  
0,320kg/mt

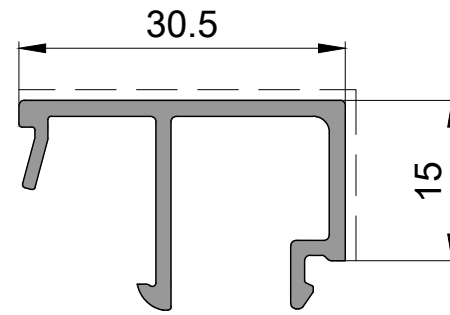

**P 2184**

Çıta Profili / glazing bead profile  
0,340kg/mt

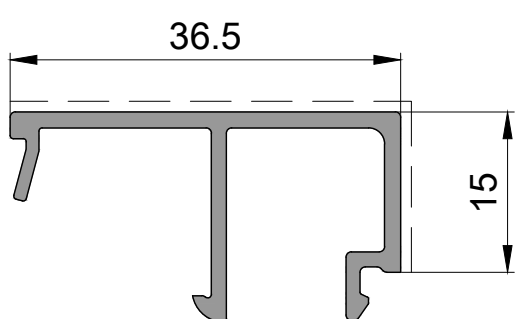

**P 1371**

Kapı Çıta Profili / door slat profile  
0,170kg/mt

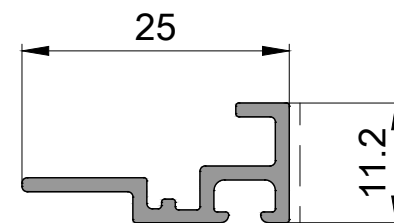

**P 1207**

Kapı Kanat Profili / Door Sash Profile  
2,120kg/mt

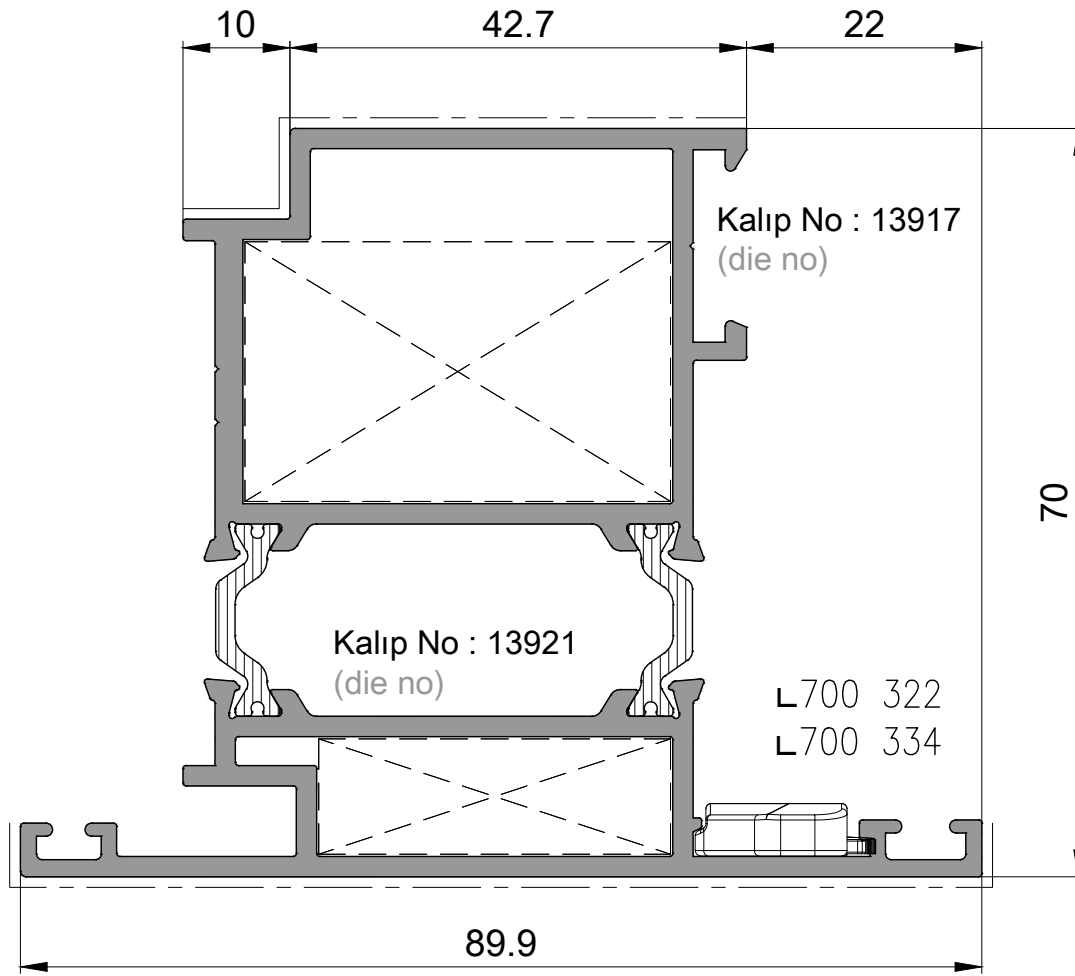

$I_x$   37.72 cm<sup>4</sup>     
  $I_y$   32.08 cm<sup>4</sup>

**P 1210**

Kapı Kasa Profili / Door Frame Profile  
2,015kg/mt

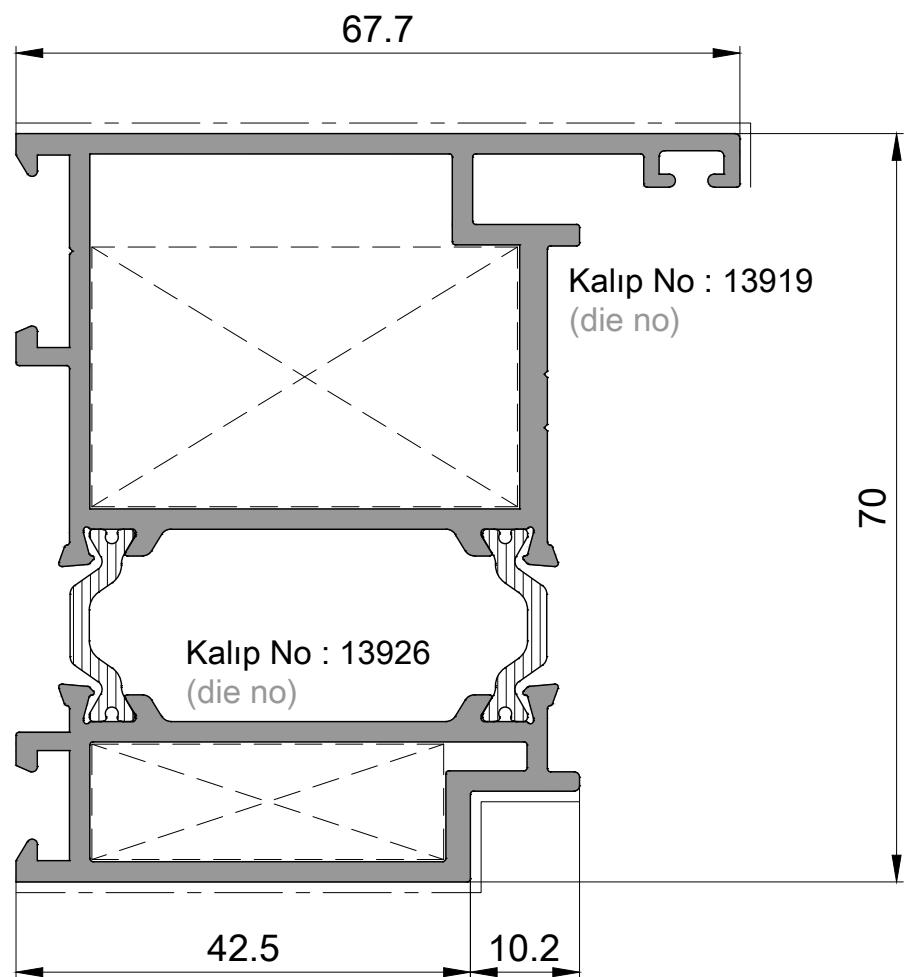

$I_x$   37.71 cm<sup>4</sup>     
  $I_y$   22.30 cm<sup>4</sup>

**P 1205**  
Kapı Kanat Profili / Door Sash Profile  
1,955kg/mt

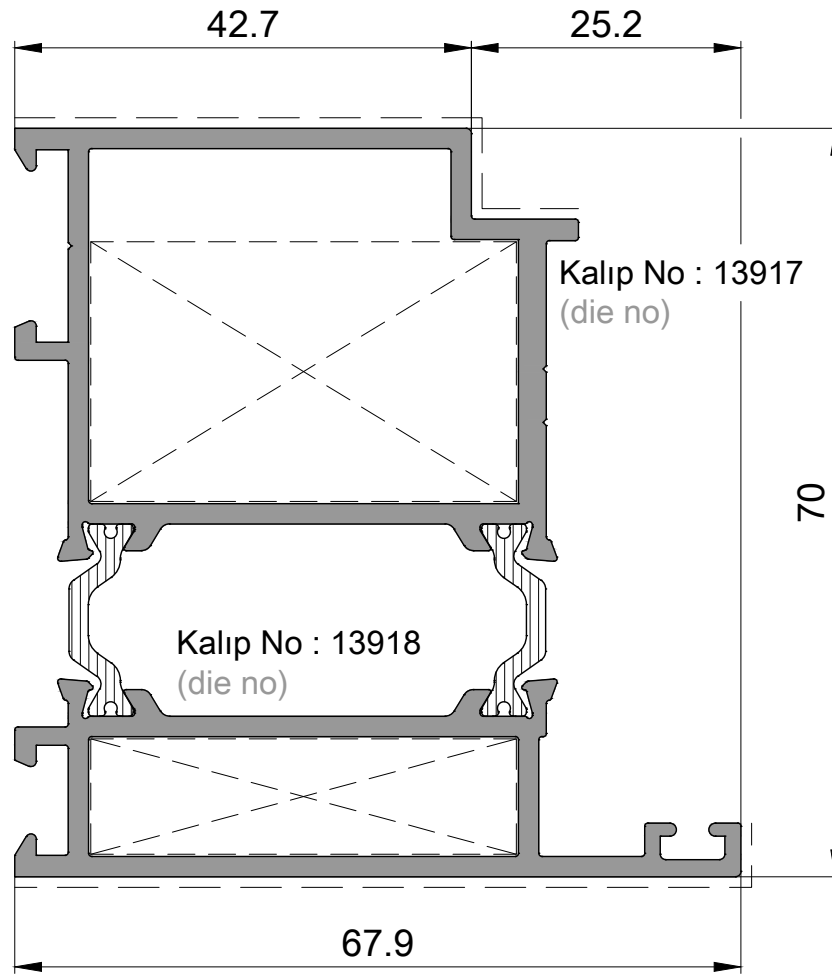

$I_x$  )  
34.69 cm<sup>4</sup>

$I_y$  )  
22.87 cm<sup>4</sup>

**P 1208**  
Adaptör Profili / Adepter Profile  
1,275kg/mt

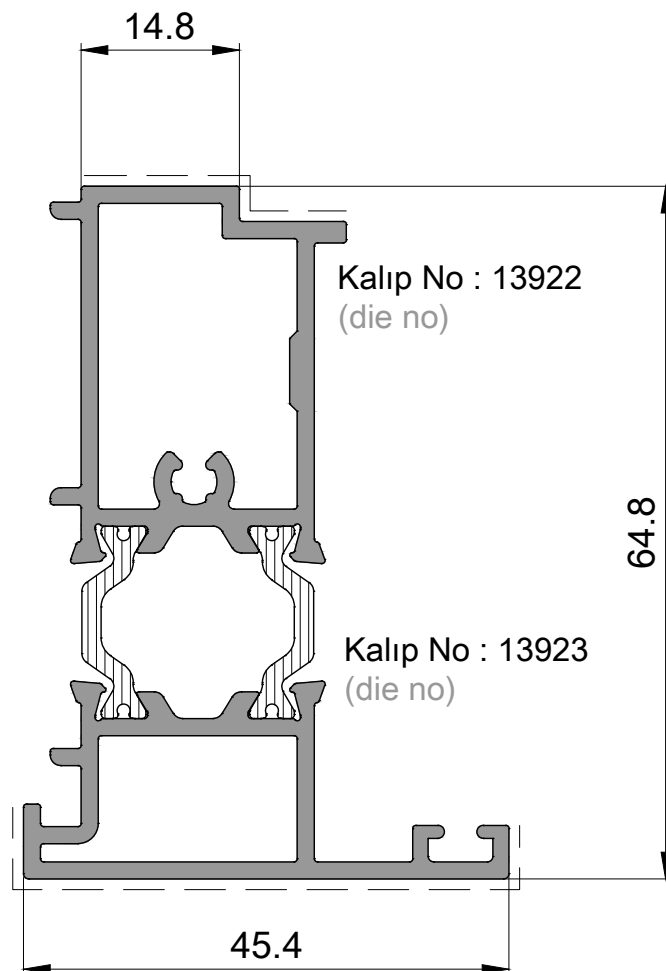

$I_x$  )  
15.21 cm<sup>4</sup>

$I_y$  )  
4.78 cm<sup>4</sup>

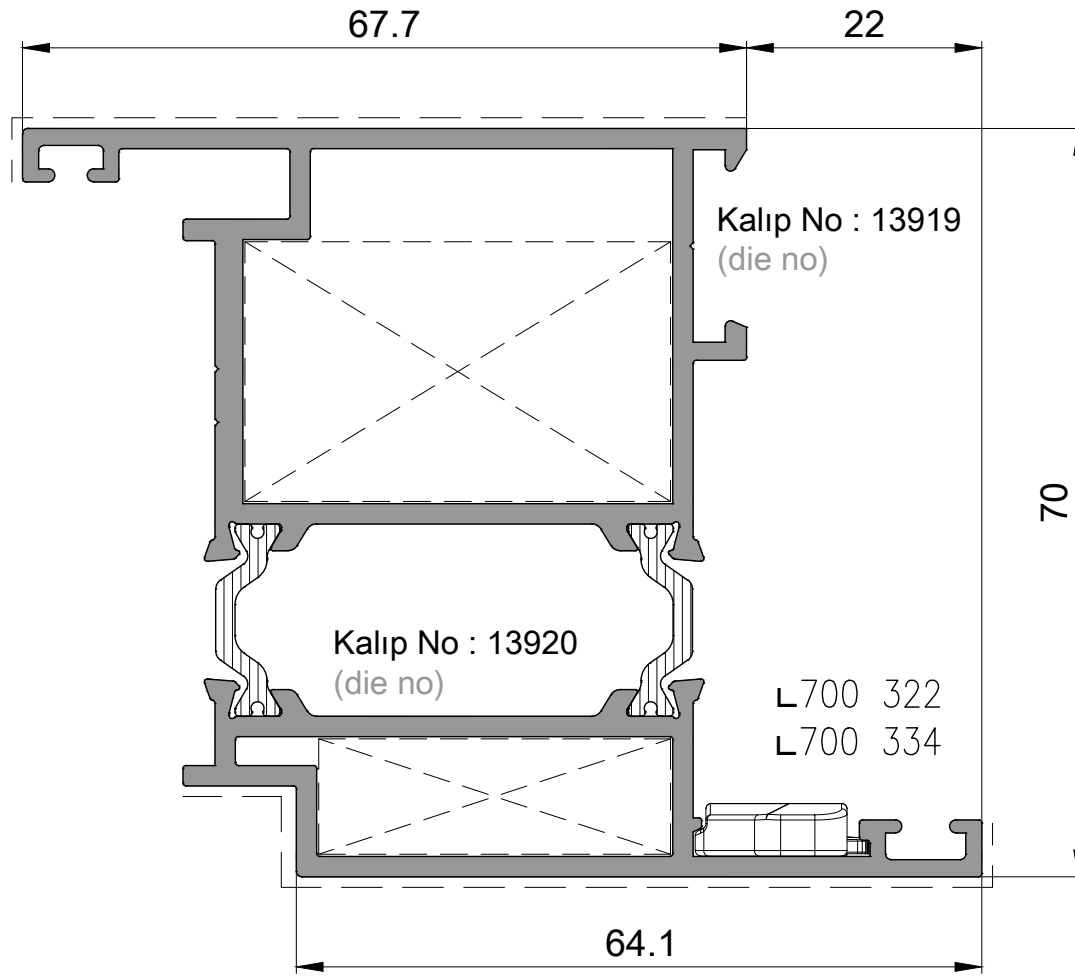

**P 1206**  
Kapı Kanat Profili / Door Sash Profile  
2,115kg/mt



$I_x$   46.21 cm<sup>4</sup>     
  $I_y$   24.91 cm<sup>4</sup>

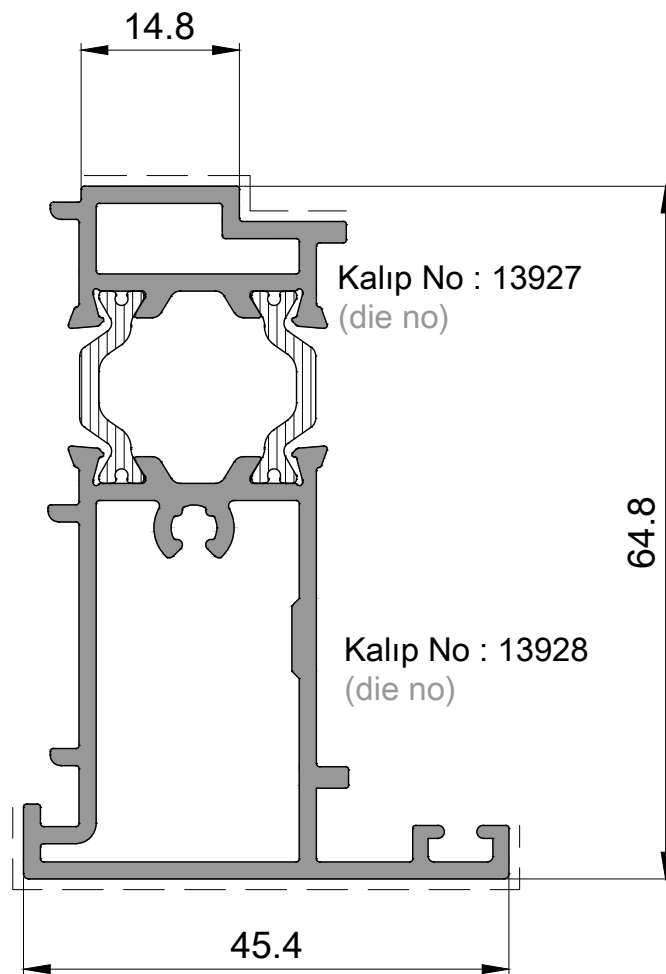

**P 1211**  
Adaptör Profili / Adepter Profile  
1,295kg/mt

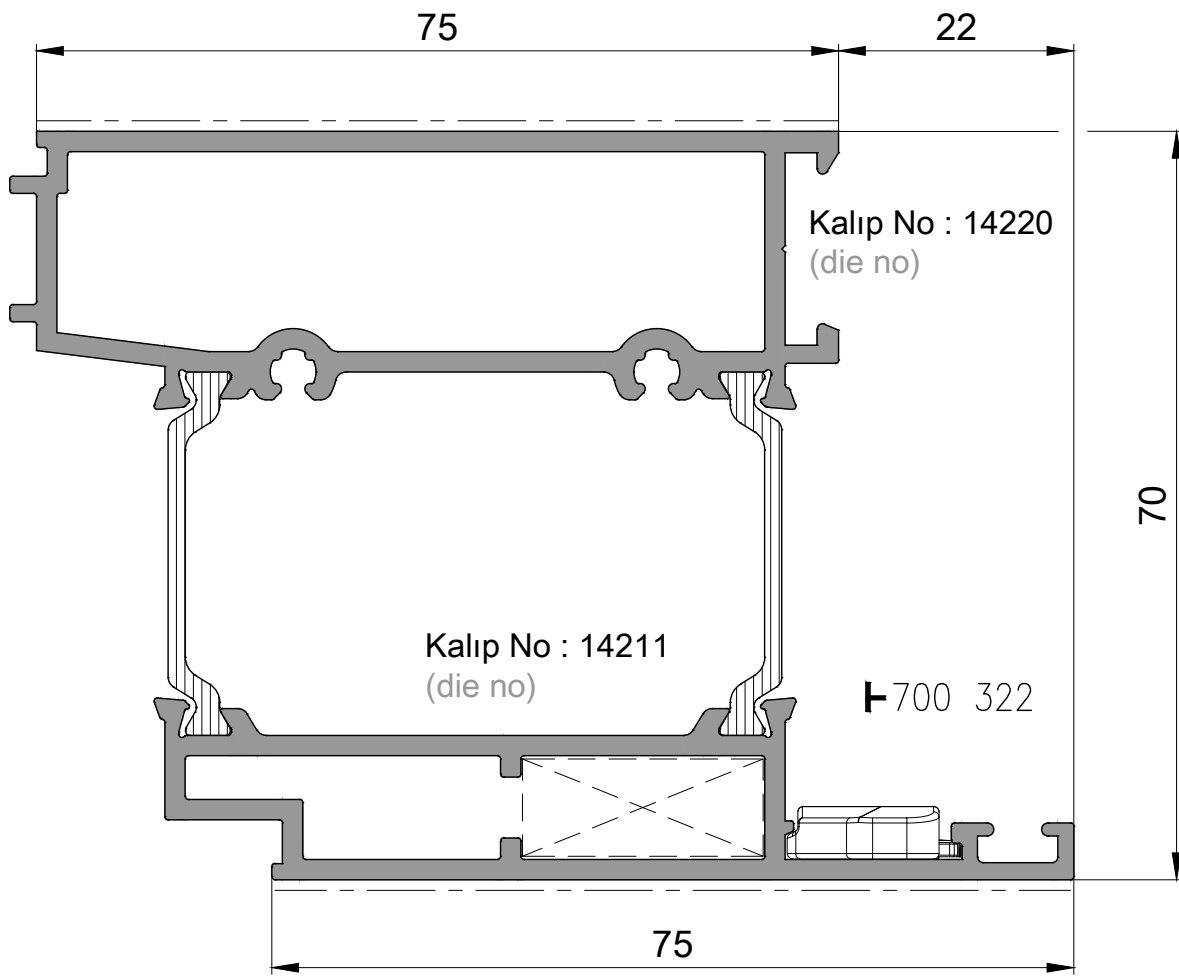

$I_x$   16.33 cm<sup>4</sup>     
  $I_y$   4.86 cm<sup>4</sup>

**P 1334**  
Etek Ek Profili / Additional Sill Profile  
2,310kg/mt



$I_x$   32.42 cm<sup>4</sup>     
  $I_y$   66.16 cm<sup>4</sup>

**P 1028**  
Etek Ek Profili / Additional Sill Profile  
1,750kg/mt

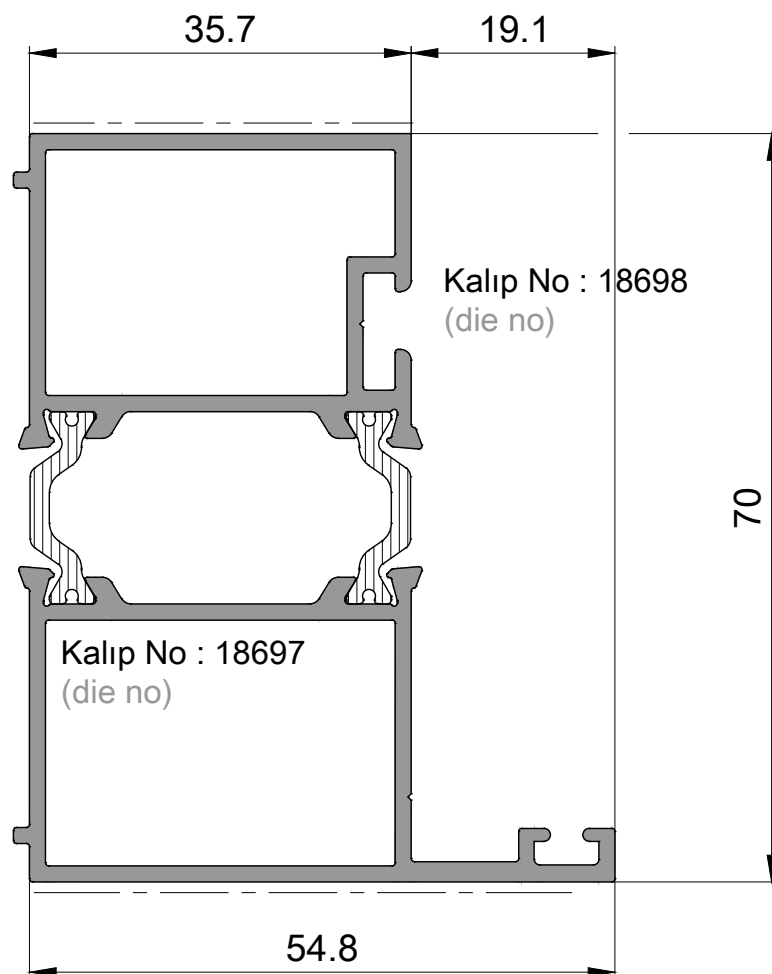

**P 1215**  
Etek Profili / Sill Profile  
3,150kg/mt

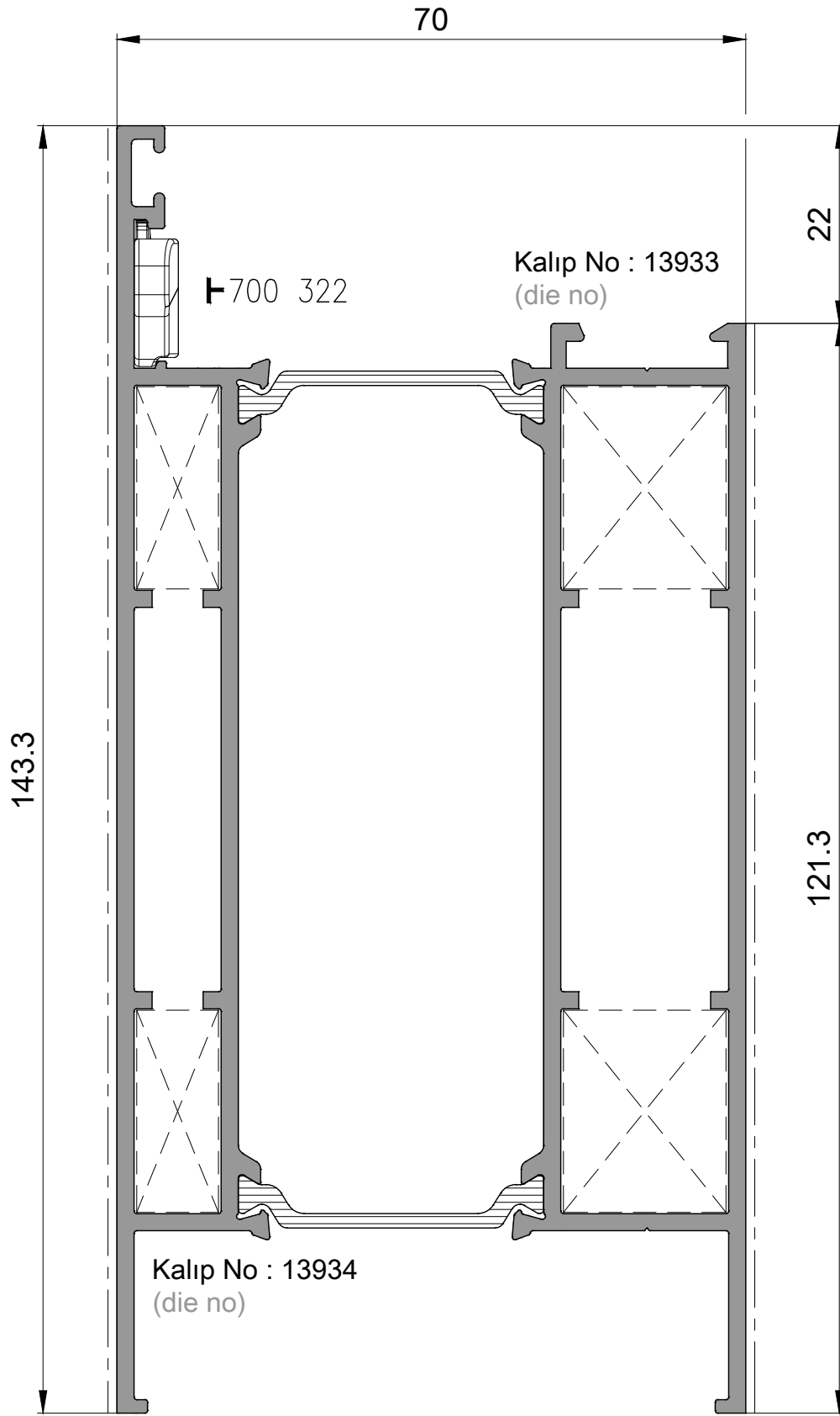

$I_x$  )  
69.39 cm<sup>4</sup>

$I_y$  )  
154.27 cm<sup>4</sup>

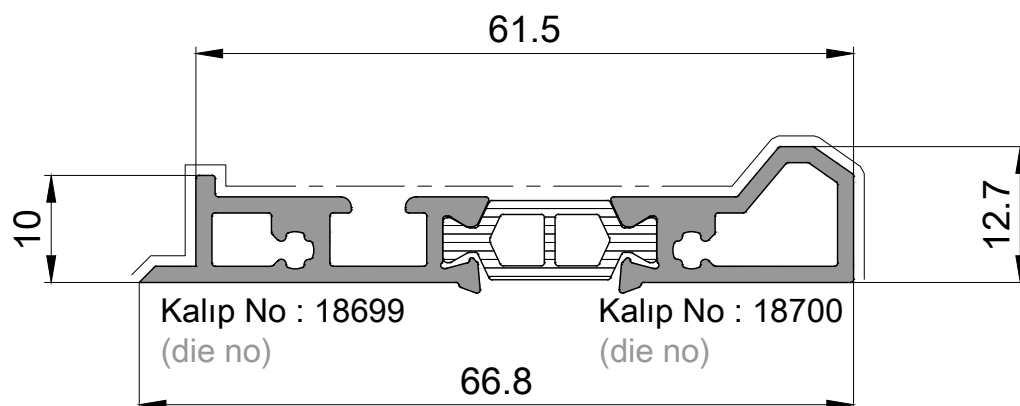

**P 1029**  
Eşik Profili / Threshold Profile  
0,710kg/mt

P 2518  
Etek Profili / Sill Profile  
3,890kg/mt

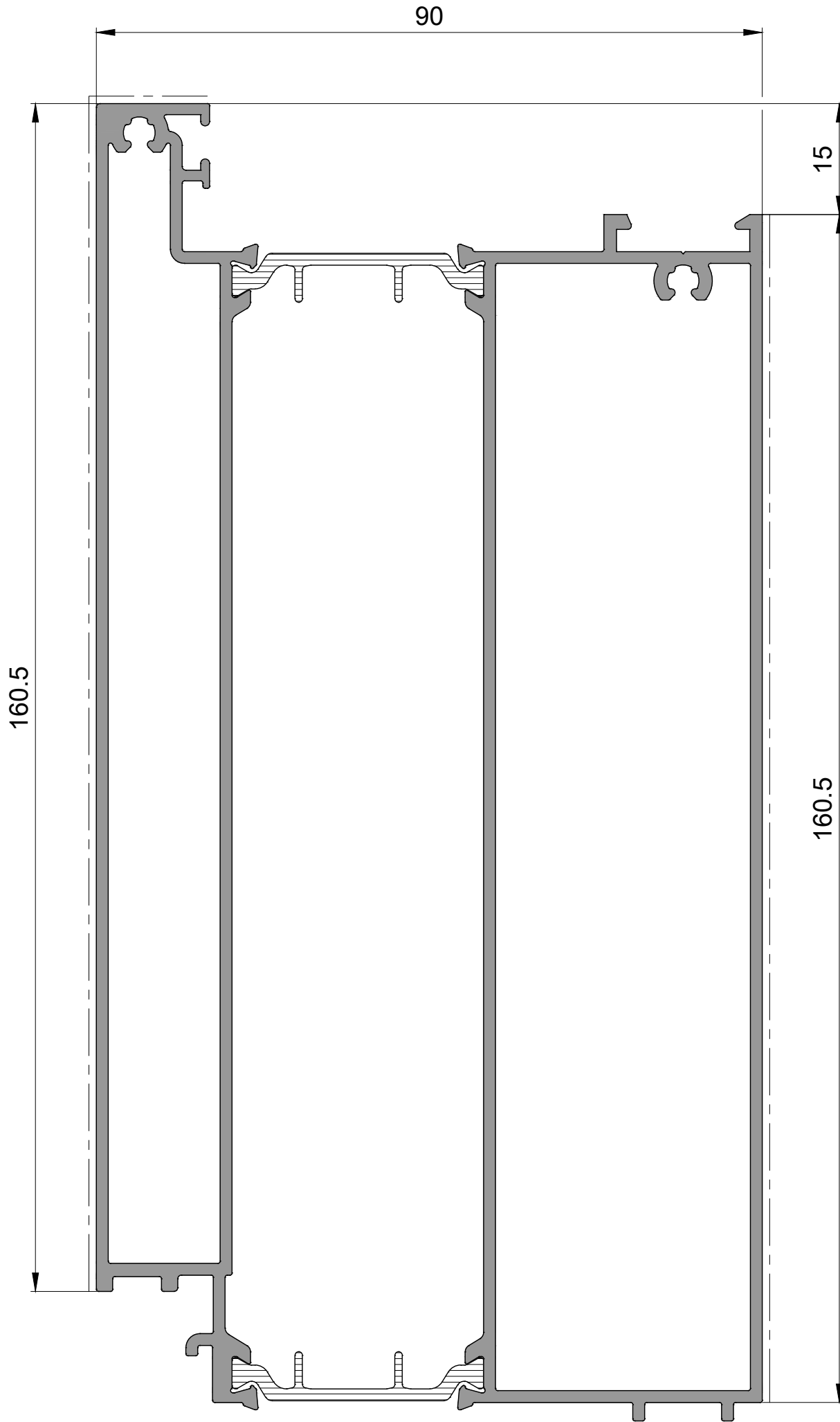

$I_x$  )  
111.48 cm<sup>4</sup>

$I_y$  )  
423.05 cm<sup>4</sup>



**P 1176**

Çıta Profili / 0,335kg/mt  
Glazing Bead Profile

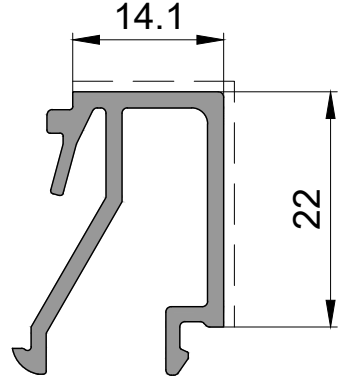

Kalıp No : 13698  
(die no)

**P 1179**

Çıta Profili / 0,350kg/mt  
Glazing Bead Profile

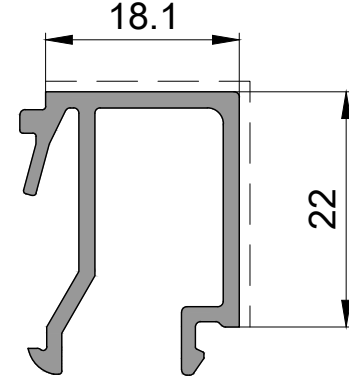

Kalıp No : 13671  
(die no)

**P 1180**

Çıta Profili / 0,380kg/mt  
Glazing Bead Profile

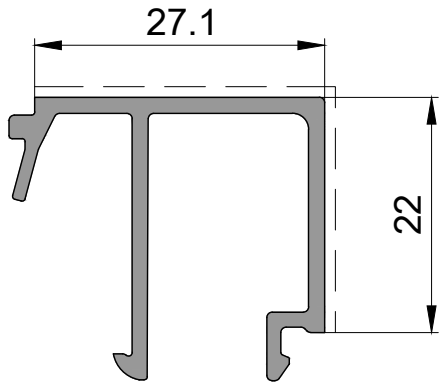

Kalıp No : 13670  
(die no)

**P 1105**

Çıta Profili / 0,360kg/mt  
Glazing Bead Profile

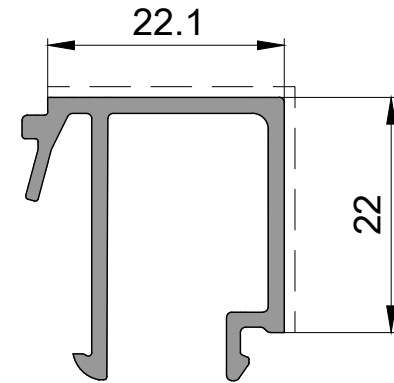

Kalıp No : 13113  
(die no)

**P 1158**

Çıta Profili / 0,365kg/mt  
Glazing Bead Profile

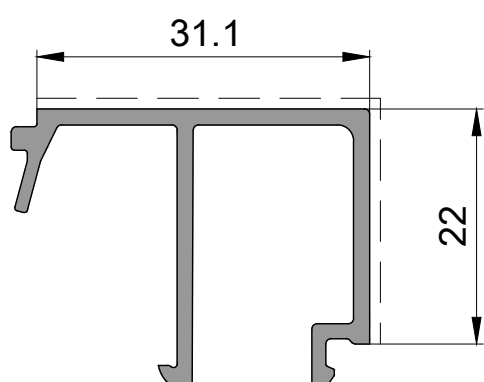

Kalıp No : 13111  
(die no)

**P 1498**

Çıta Profili / 0,415kg/mt  
Glazing Bead Profile

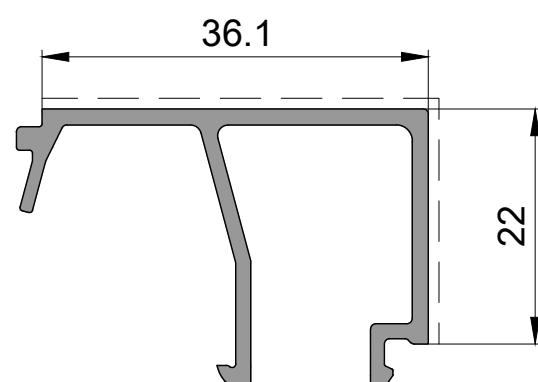

Kalıp : 15310  
(die no)

**P 1494**  
Çıta Profili / 0,325kg/mt  
Glazing Bead Profile

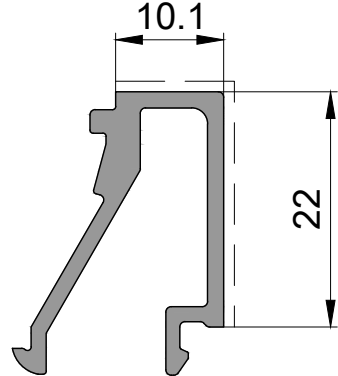

Kalıp : 15306  
(die no)

**P 1495**  
Çıta Profili / 0,270kg/mt  
Glazing Bead Profile

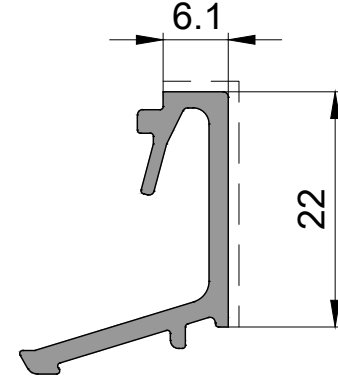

Kalıp : 15307  
(die no)

**P 1496**  
Çıta Profili / 0,245kg/mt  
Glazing Bead Profile

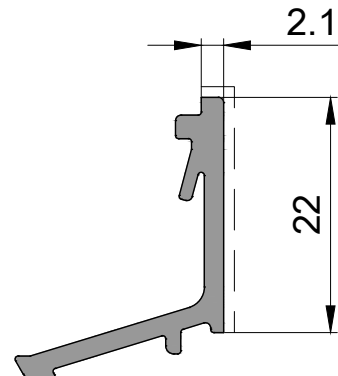

Kalıp : 15308  
(die no)

**P 1497**  
Çıta Profili / 0,435kg/mt  
Glazing Bead Profile

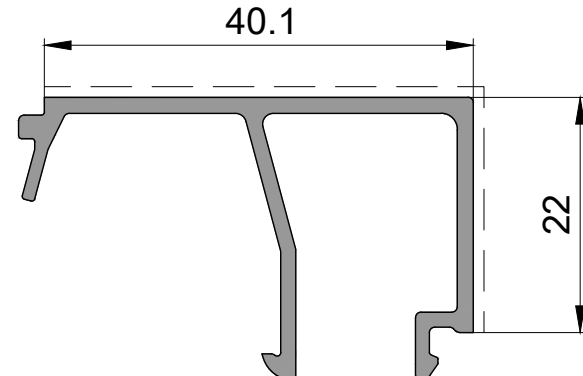

Kalıp : 15309  
(die no)

**P 2414**  
Çıta Profili / glazing bead profile  
0,235kg/mt

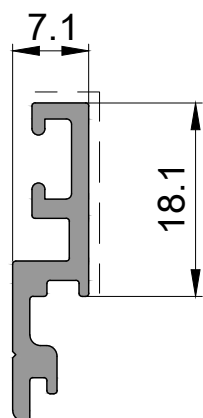

Kalıp No : 18910  
(die no)

**P 1020**  
Tij Profili / rodprofile  
0,105kg/mt

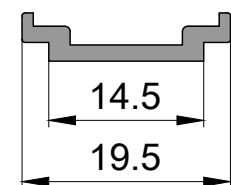

Kalıp : 12769  
(die no)

eloxal - anodising

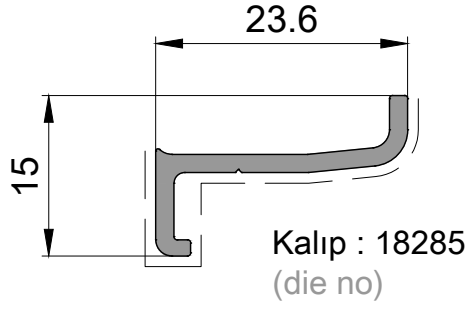

**P 2199**  
Kapı Alt Bini Profili / door bottom profile  
0,170kg/mt

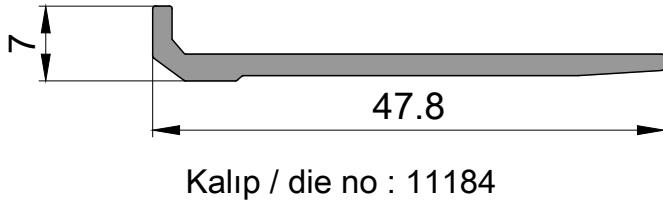

**P 1849**  
Cam Taşıyıcı / glass support  
0,280kg/mt

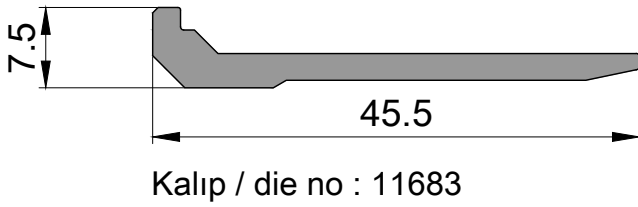

**P 1702**  
Cam Taşıyıcı / glass support  
0,355kg/mt

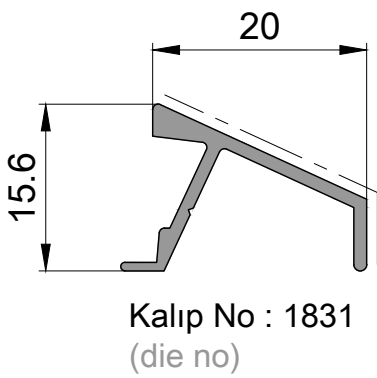

**P 2404**  
Damlalık Profili / Dropper Profile  
0,160kg/mt

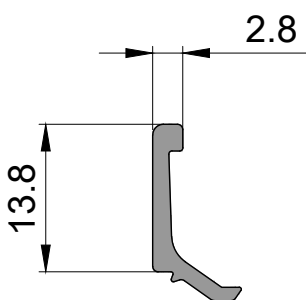

**P 1850**  
Çıta Profili / glazing bead profile  
0,100kg/mt

**P 2269**

DOGRAMA MONTAJ PROFİLİ  
Strap Anchor Profile  
2,260kg/mt

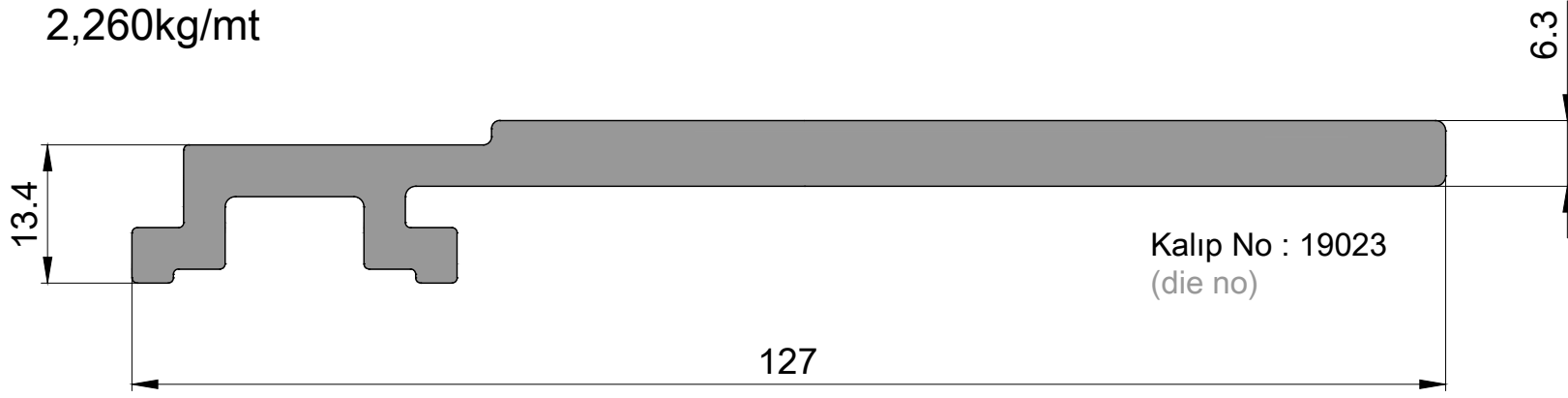

**P 2278**

DOGRAMA MONTAJ PROFİLİ  
Strap Anchor Profile  
2,105kg/mt

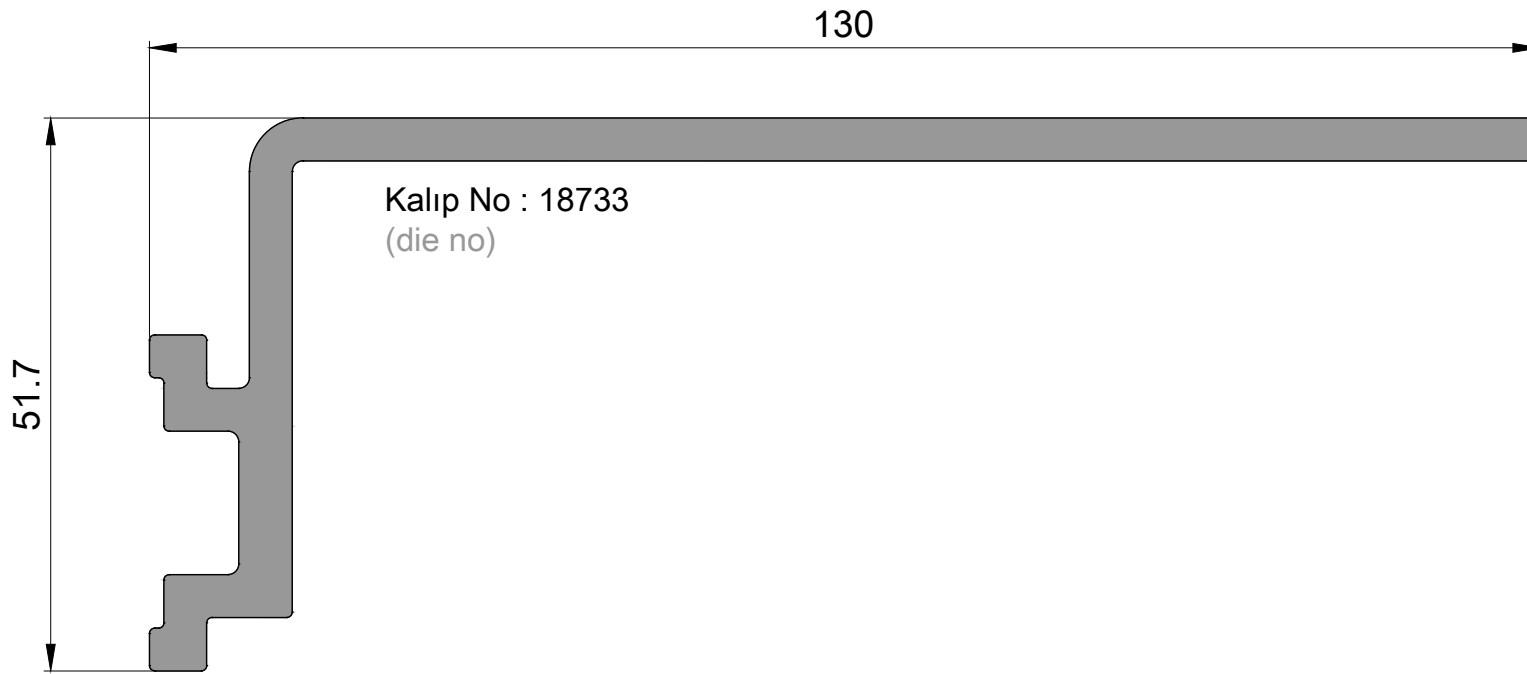

**P 1015**

Köşe Takoz Profili / 5,990kg/mt  
Corner Cleat Profile

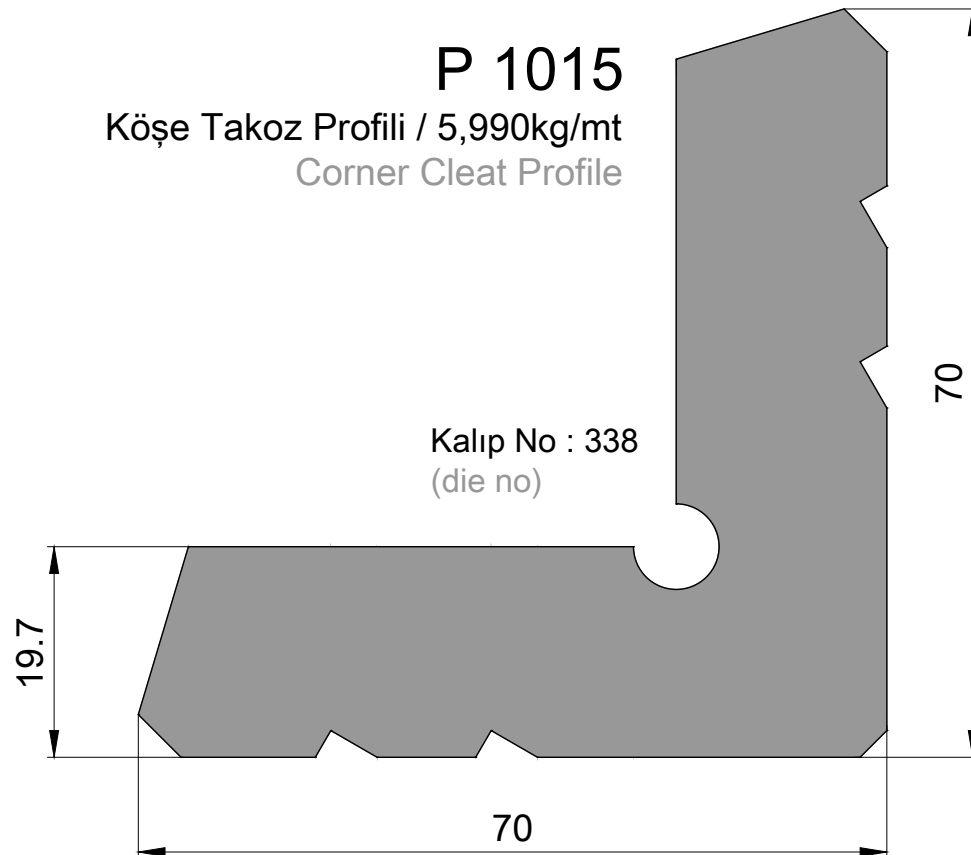

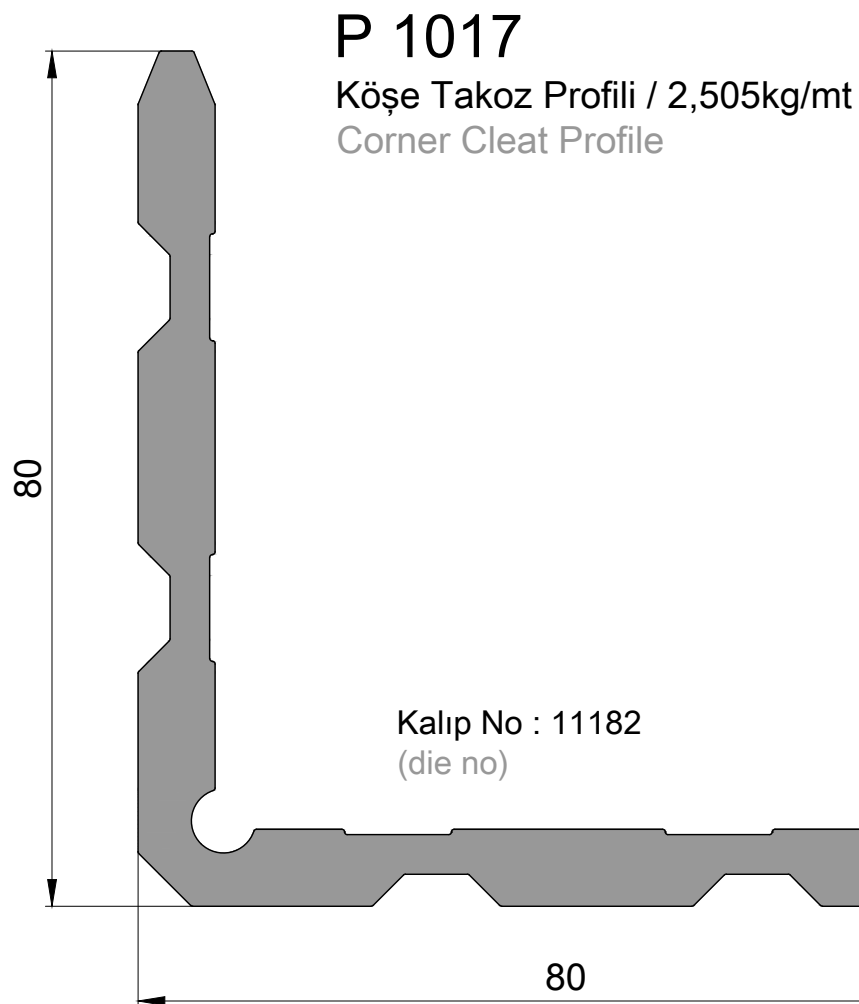
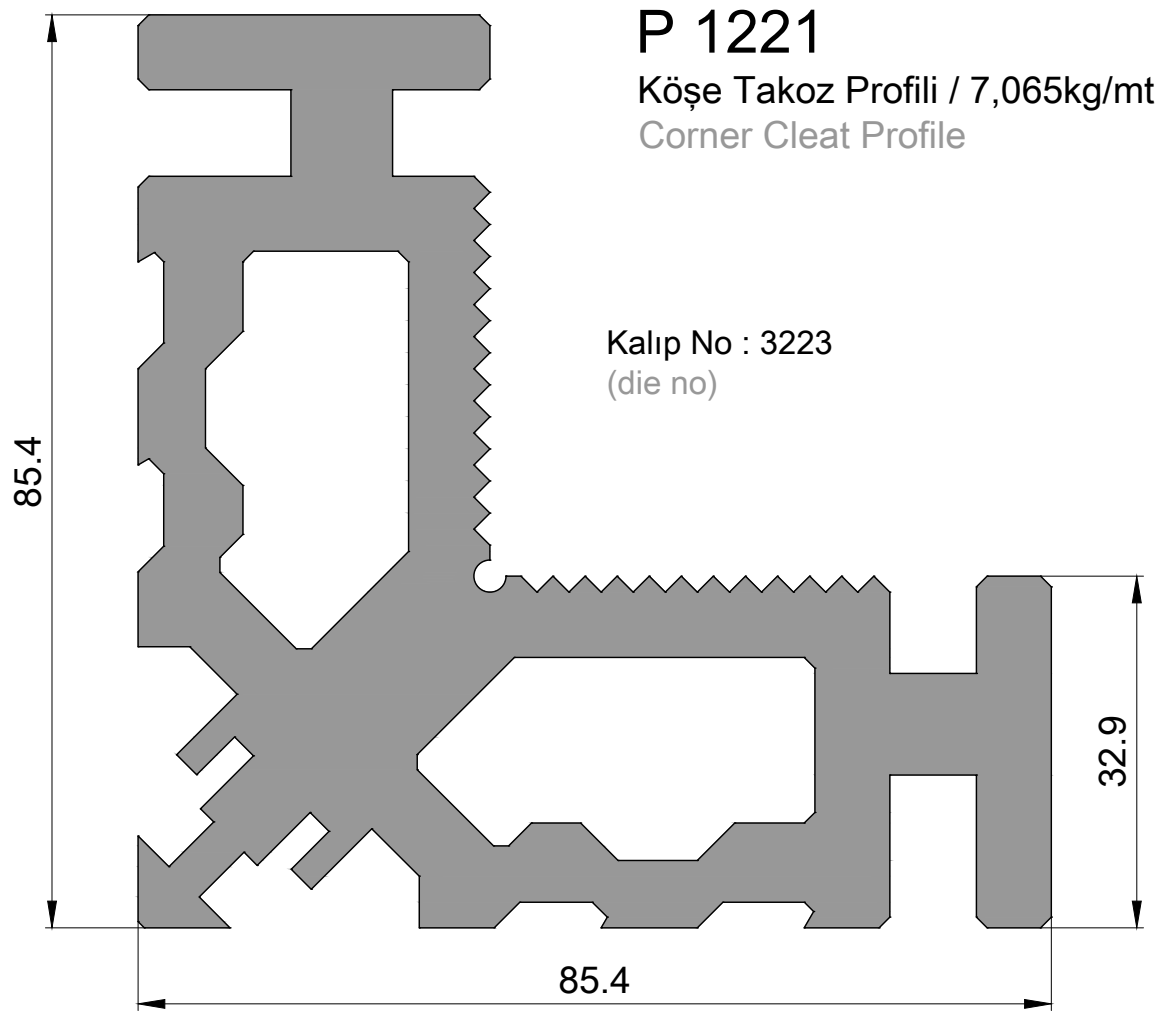

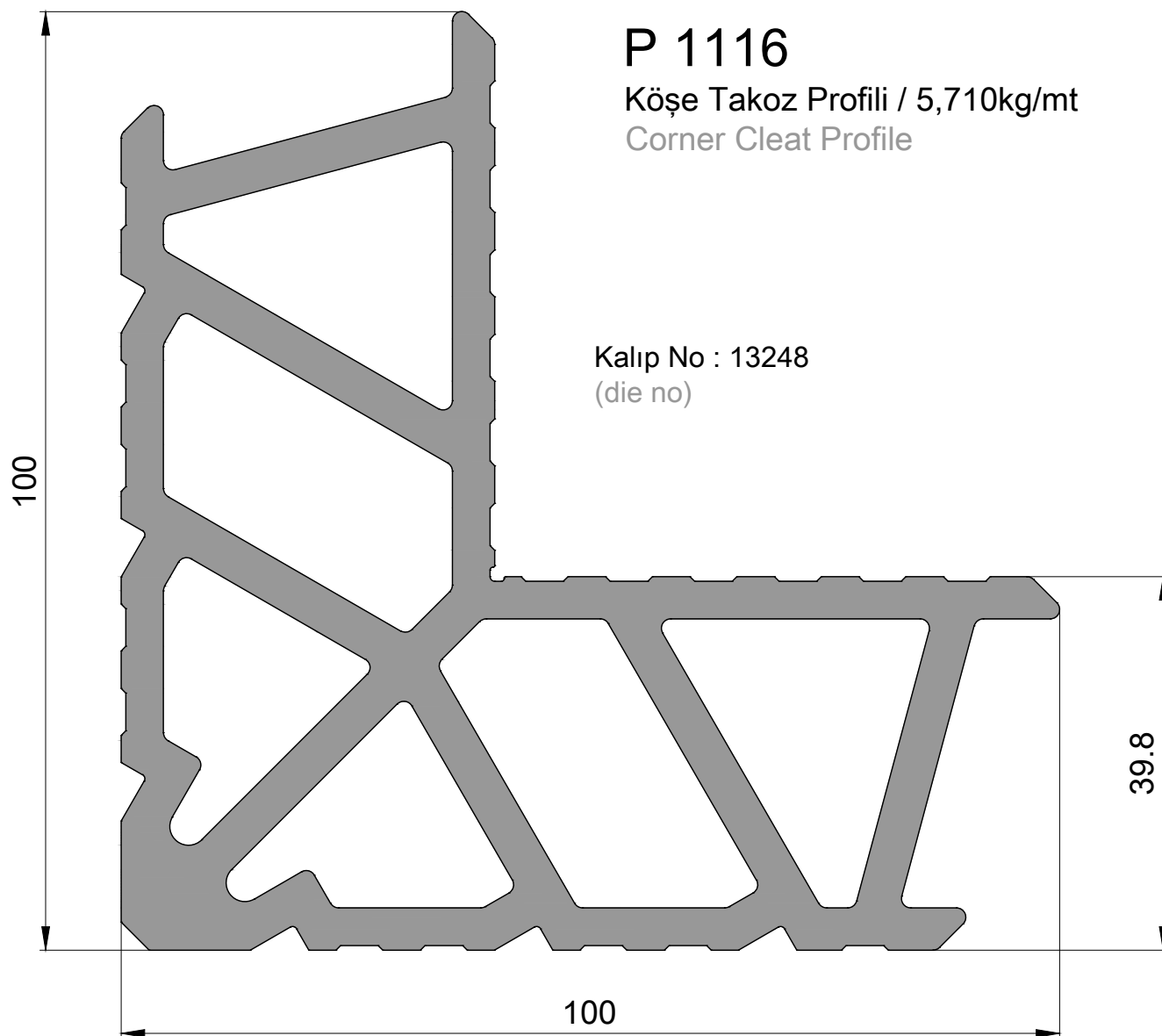
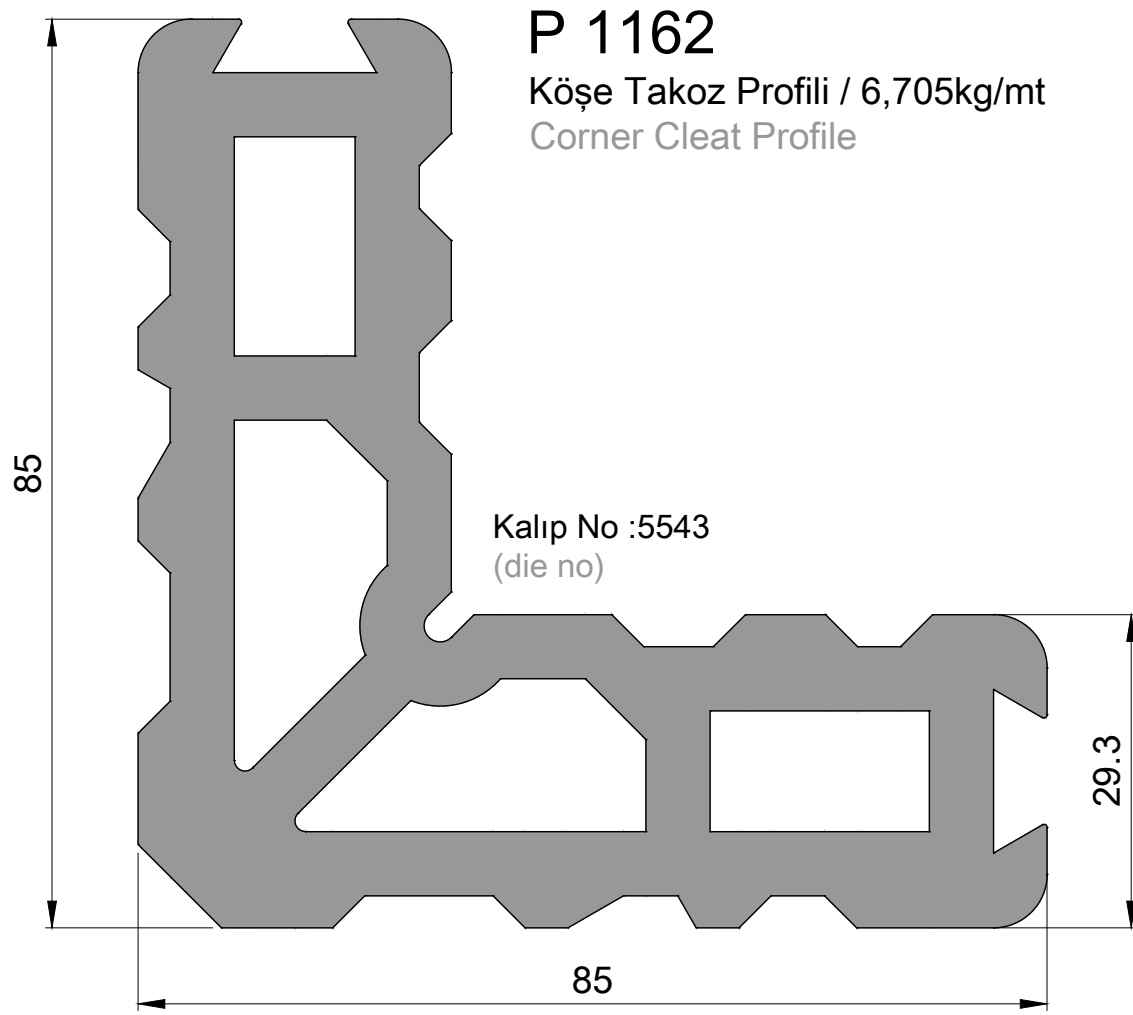

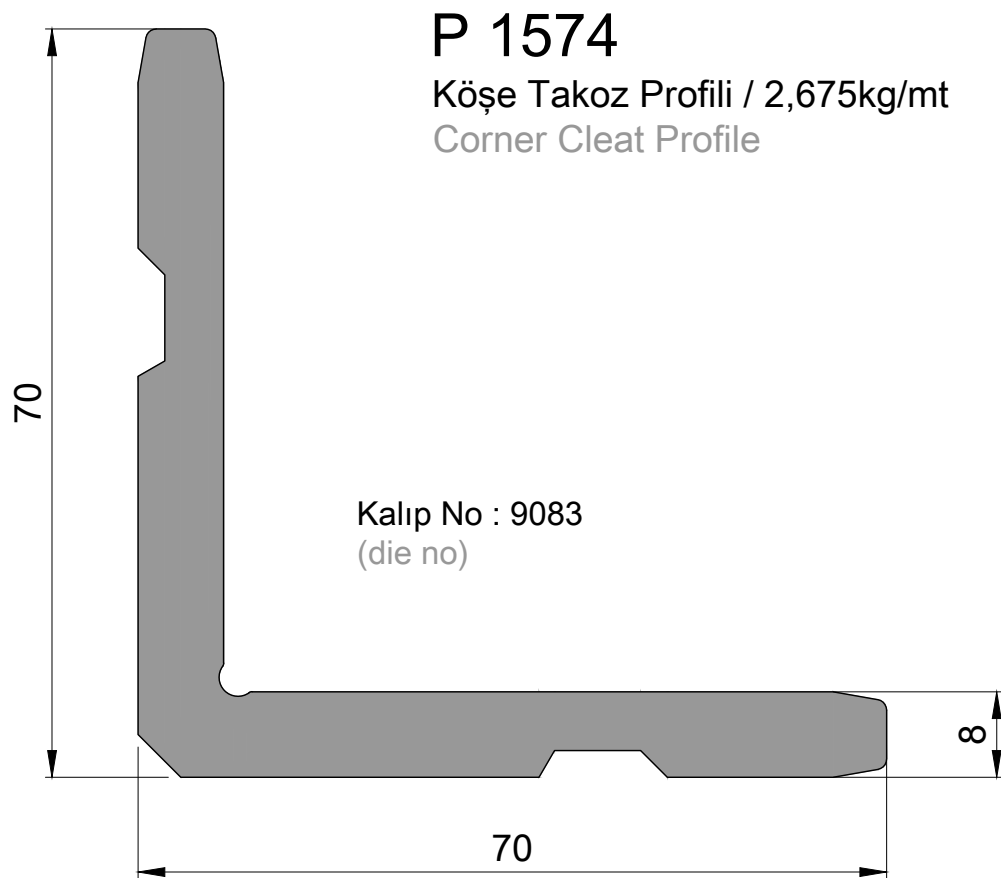
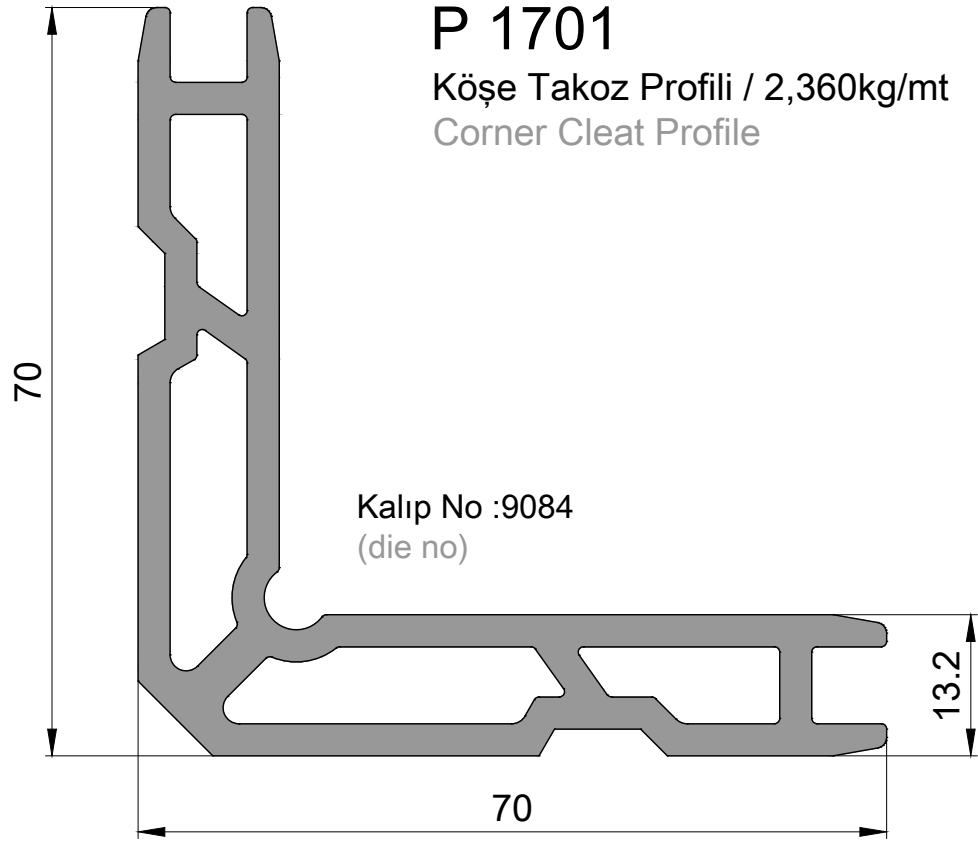

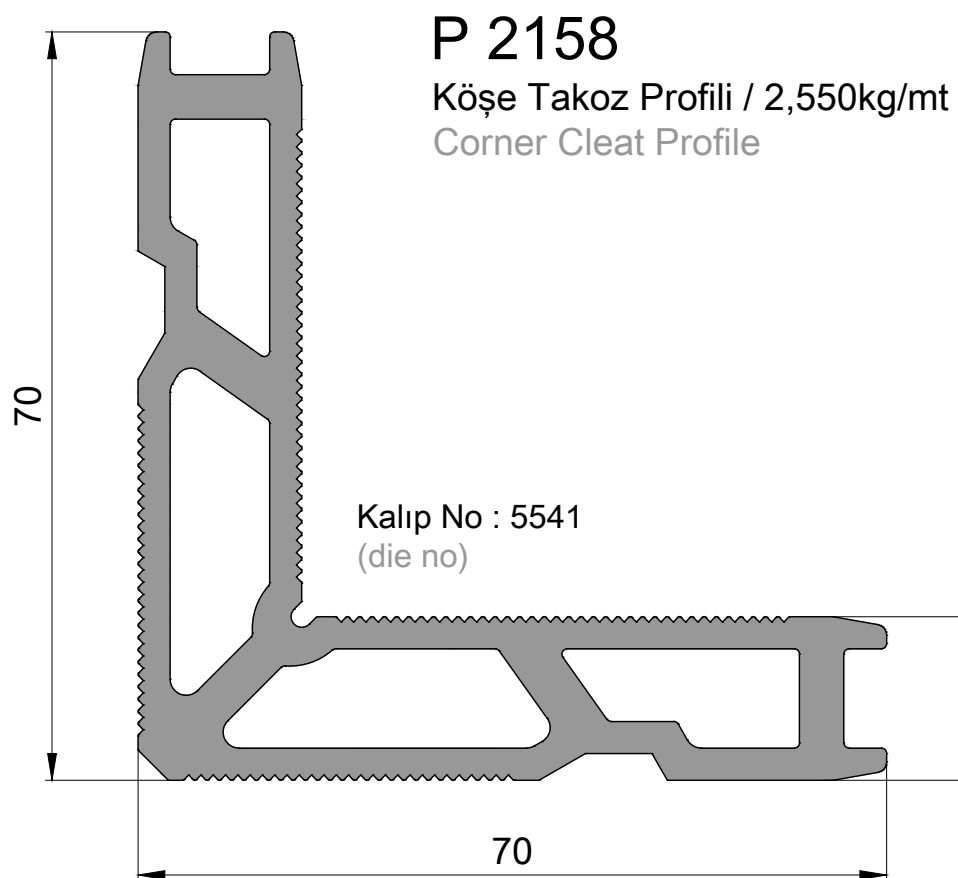
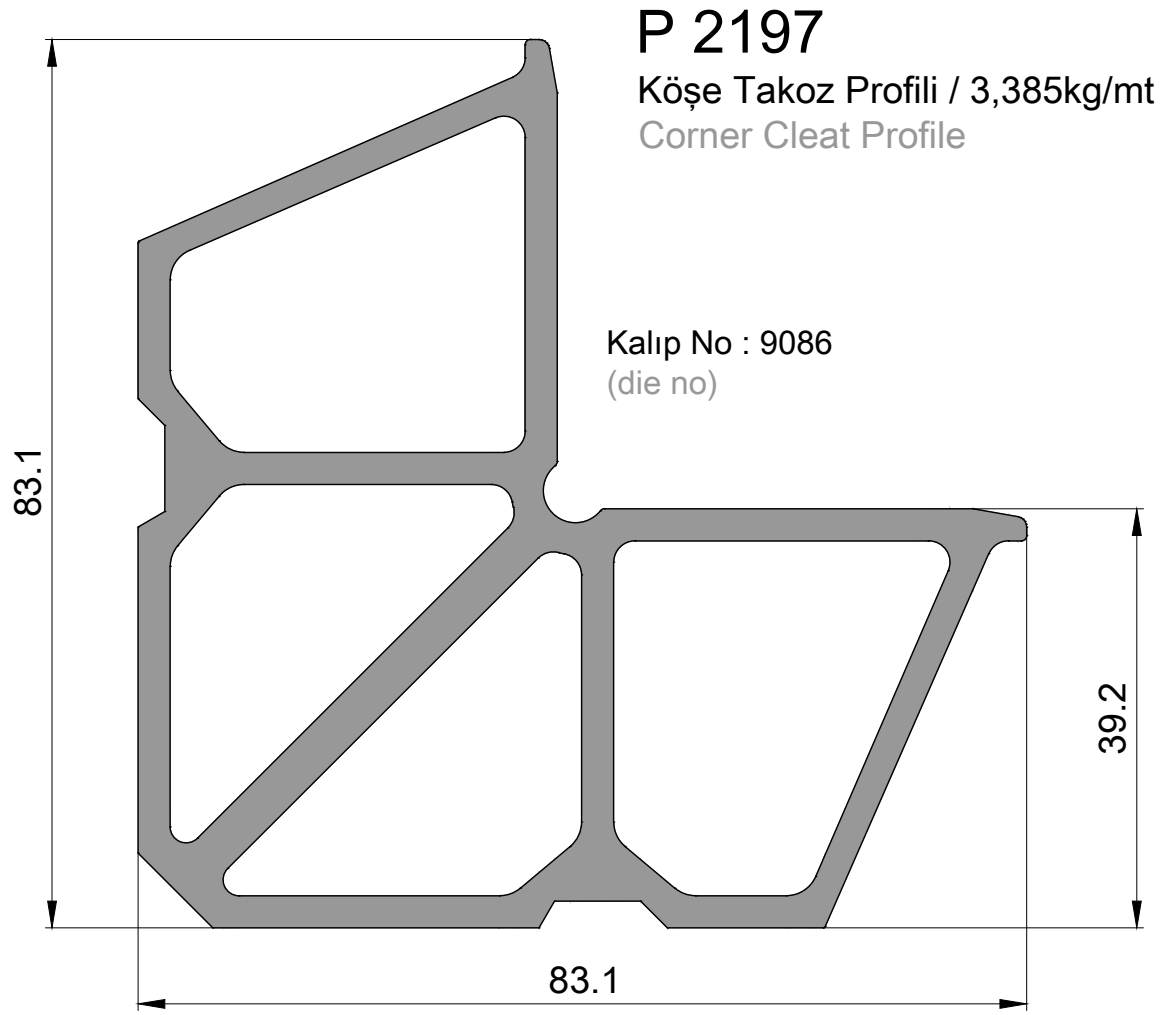



**P 1879**

Köşe Takoz Profili / 3,630kg/mt  
Corner Cleat Profile

Kalıp No : 20-5434  
(die no)

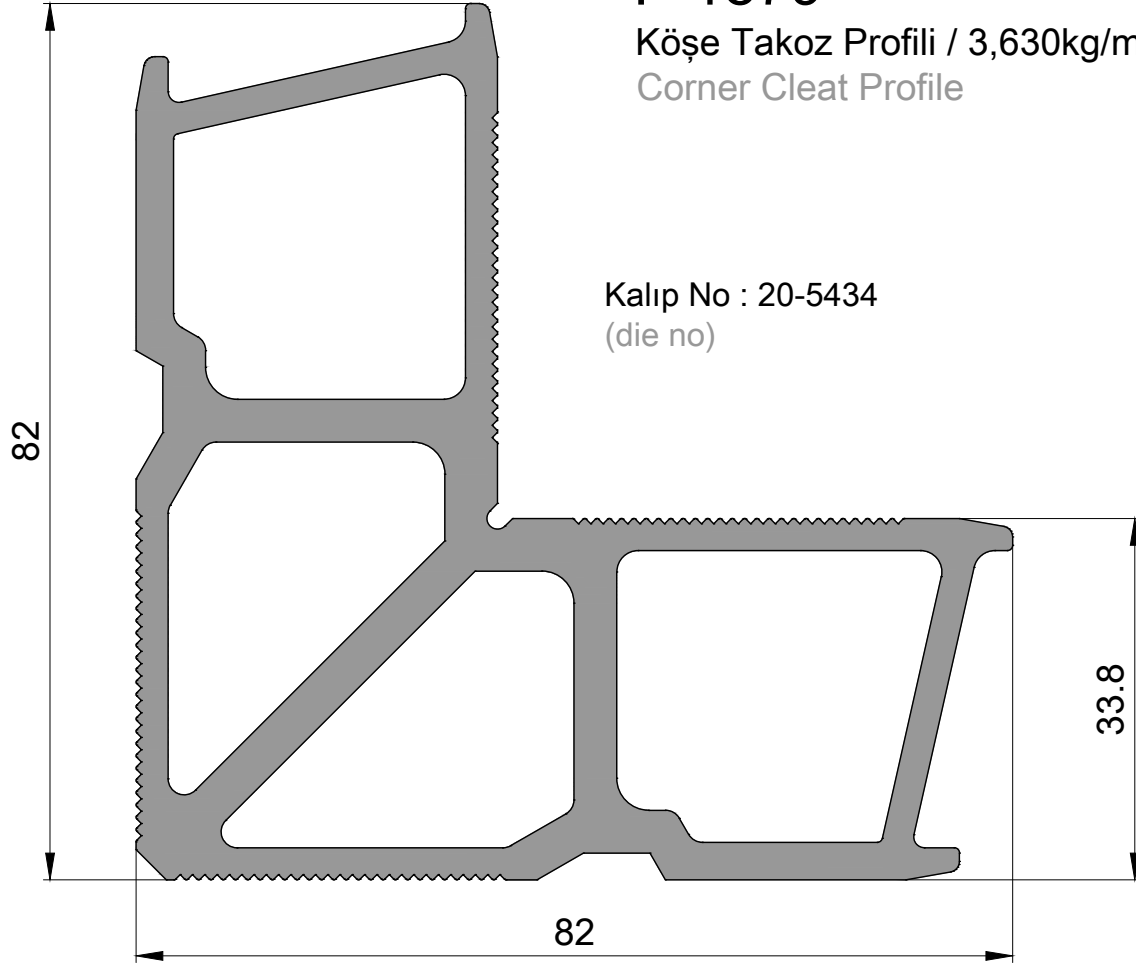

**P 2190**

Köşe Takoz Profili / 3,780kg/mt  
Corner Cleat Profile

Kalıp No : 9088  
(die no)

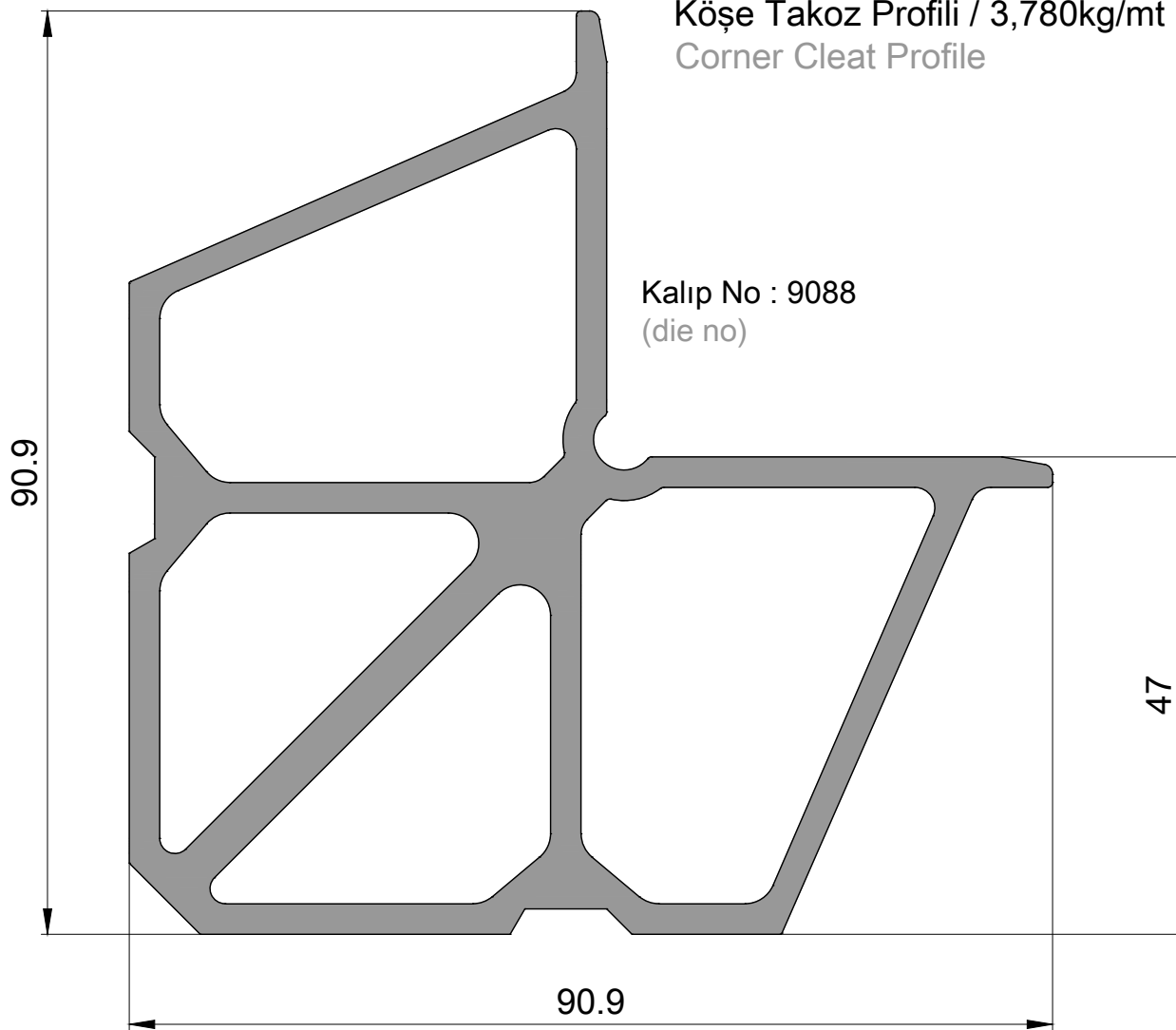

**Spectral90**  
**KATLAR ARASI DOGRAMA SİSTEMİ**  
**WINDOW WALL SYSTEM**

**PRIME WINDOW PRENSİP SİSTEM DETAYLARI**  
**PRIME WINDOW PRINCIPAL SECTIONS**

Contalı Gizli Kanat Detayları  
Gasketed Hidden Sash Sections

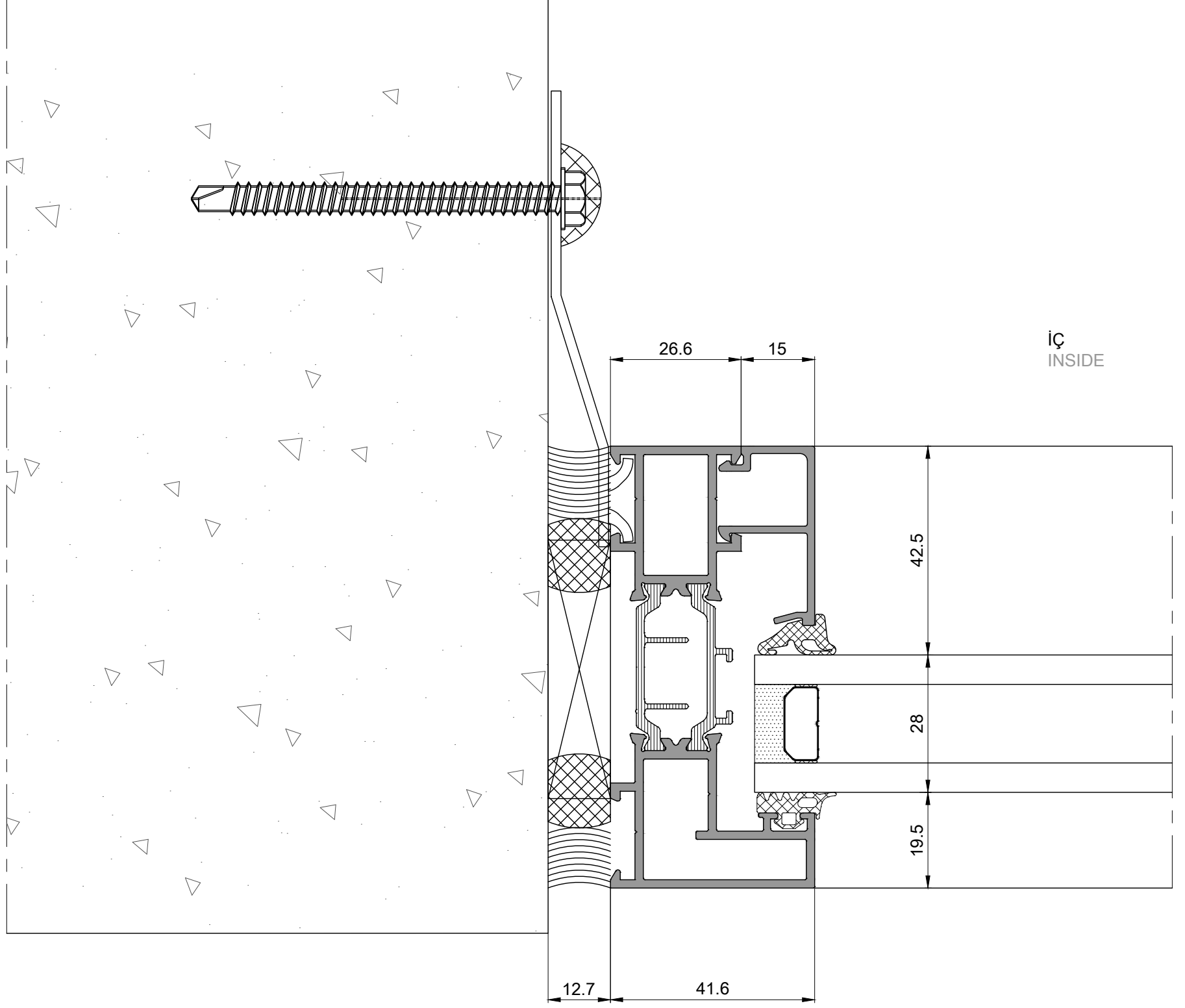
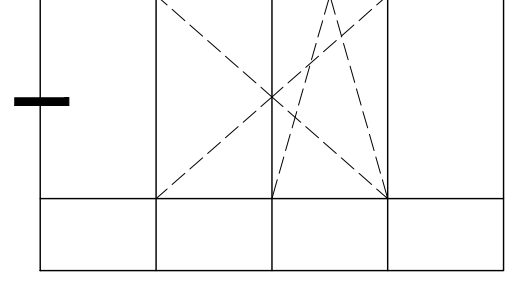

Contalı Gizli Kanat Detayları  
Gasketed Hidden Sash Sections

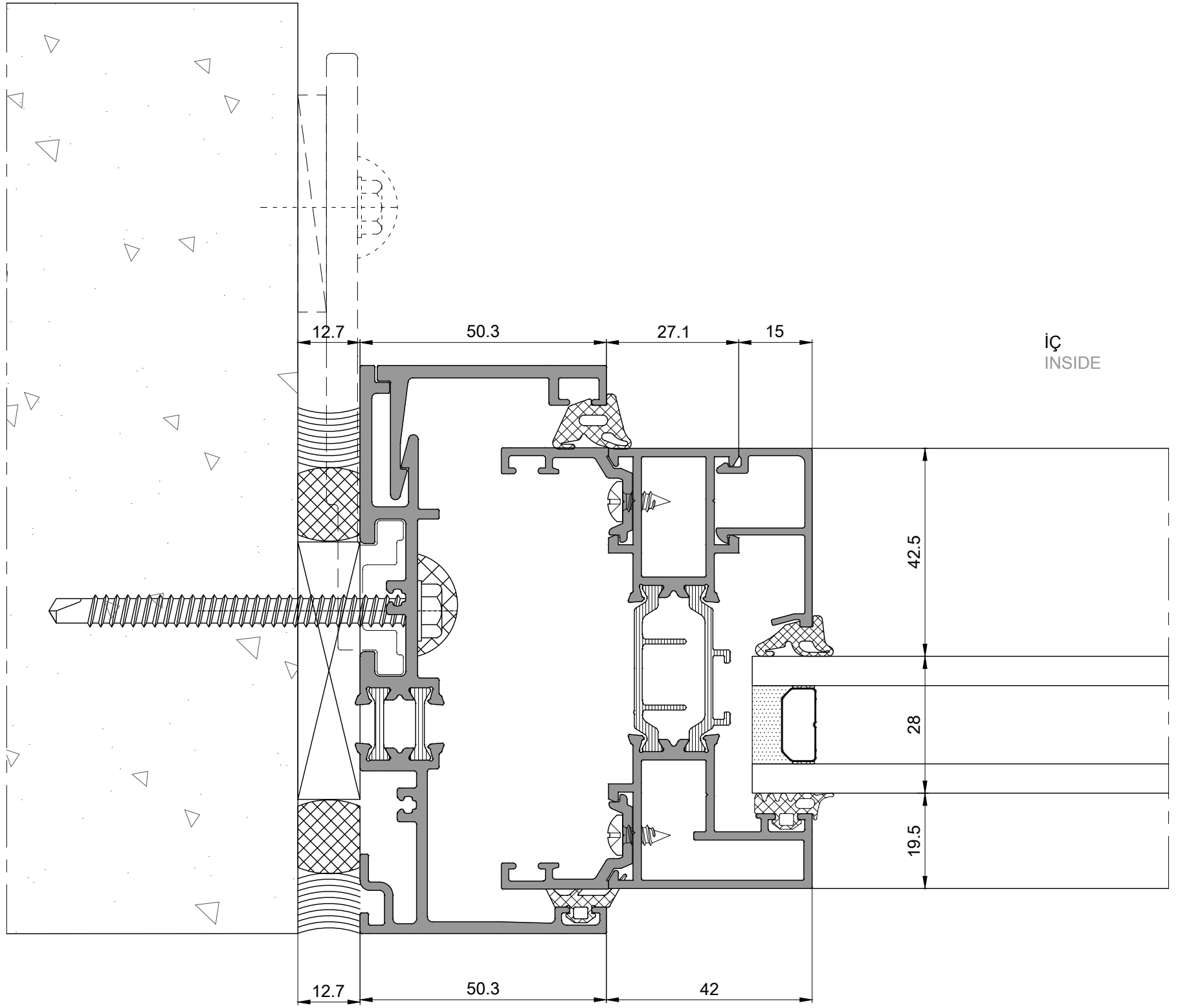
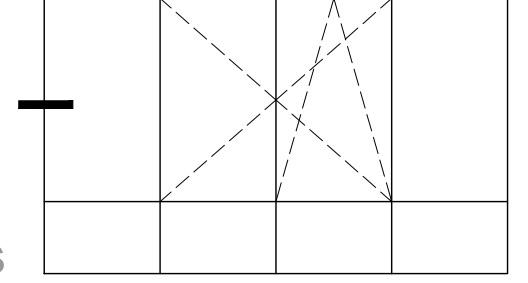

Contalı Gizli Kanat Detayları  
Gasketed Hidden Sash Sections

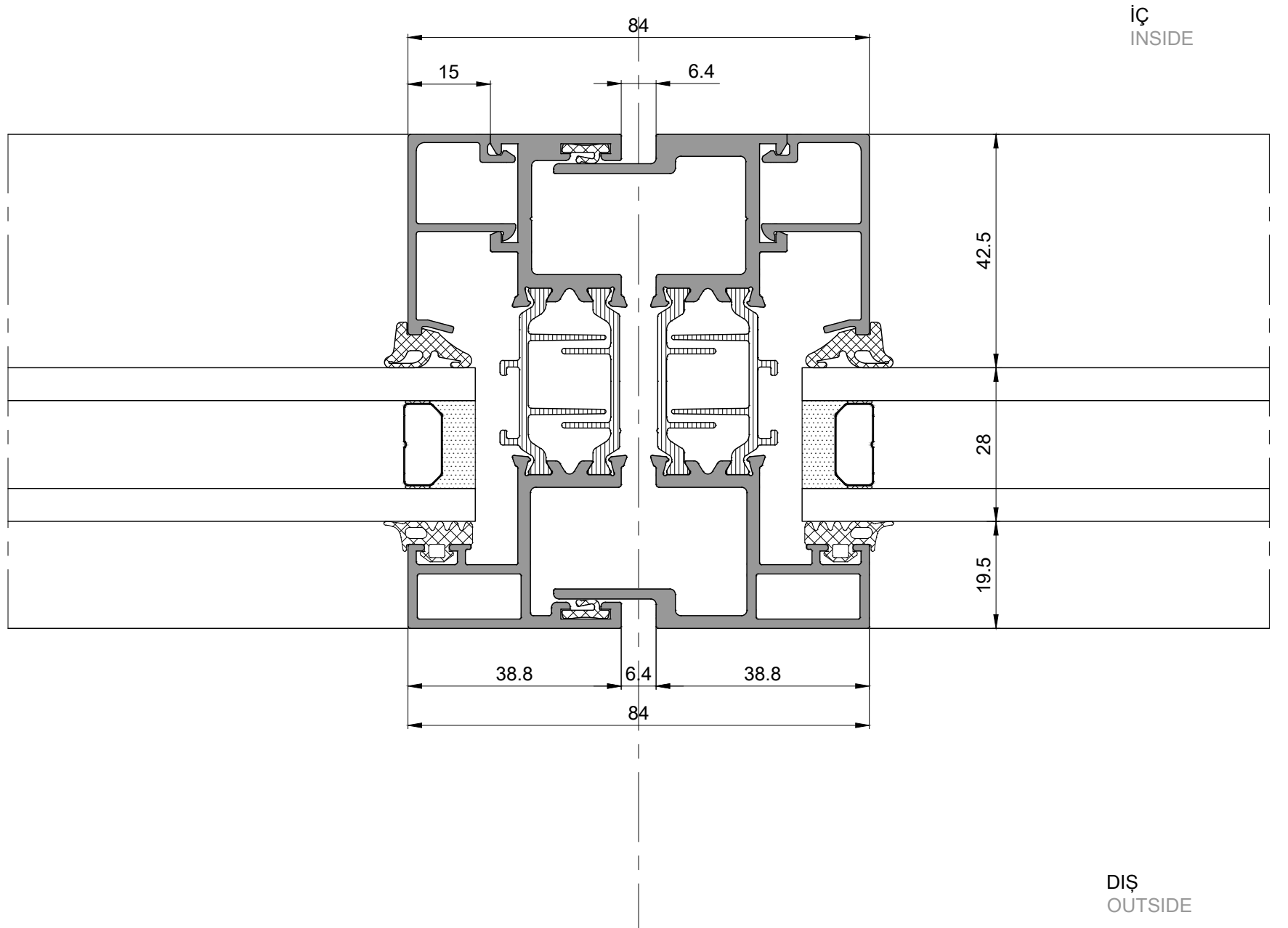
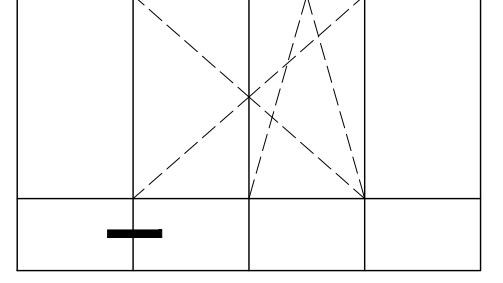

Contalı Gizli Kanat Detayları  
Gasketed Hidden Sash Sections

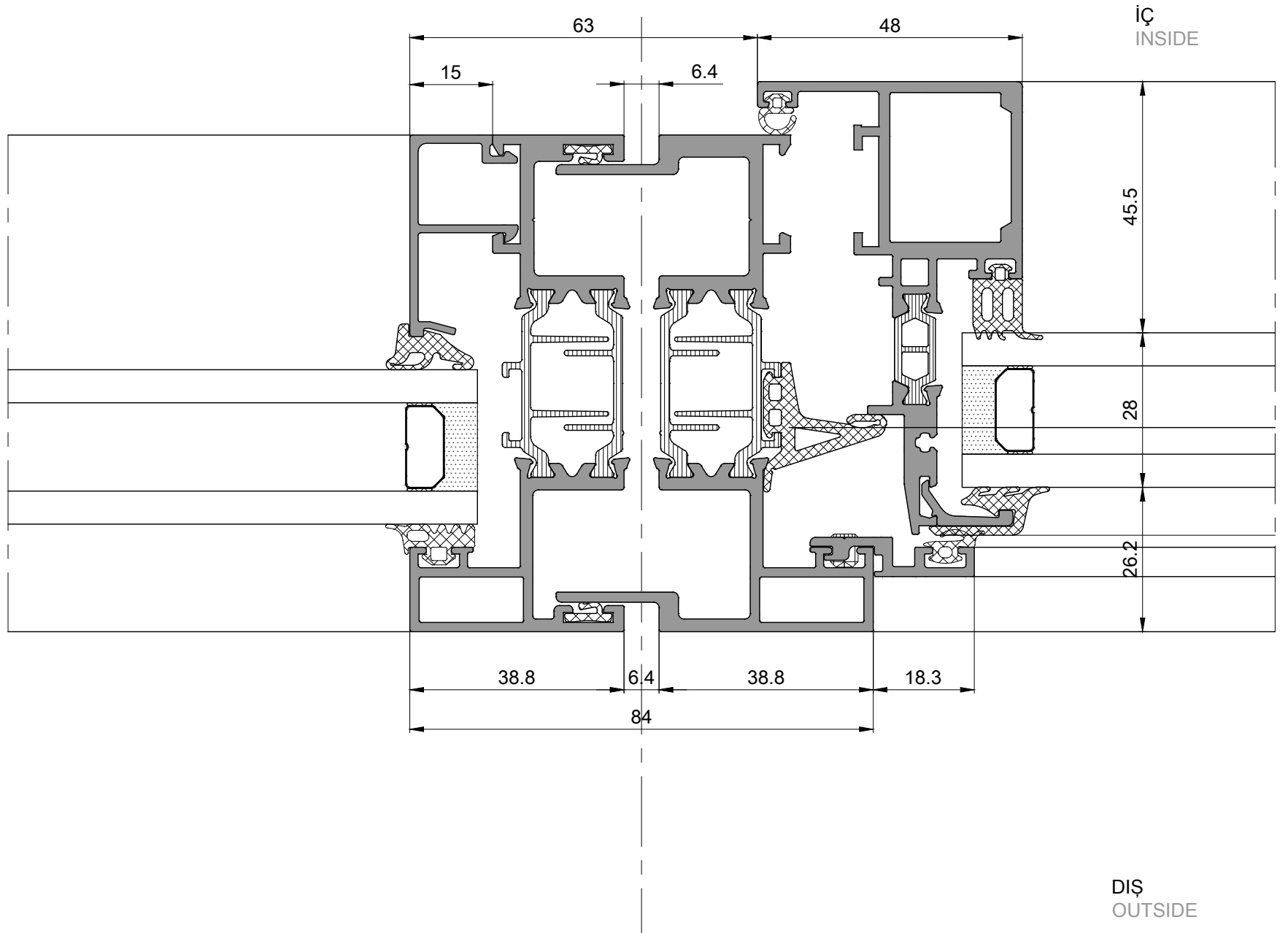
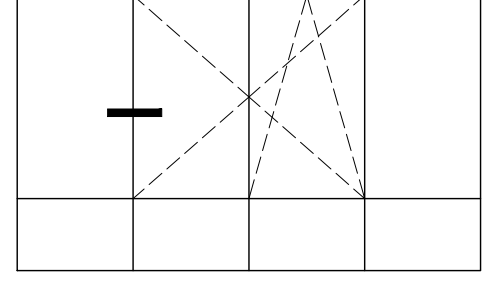

Contalı Gizli Kanat Detayları  
Gasketed Hidden Sash Sections

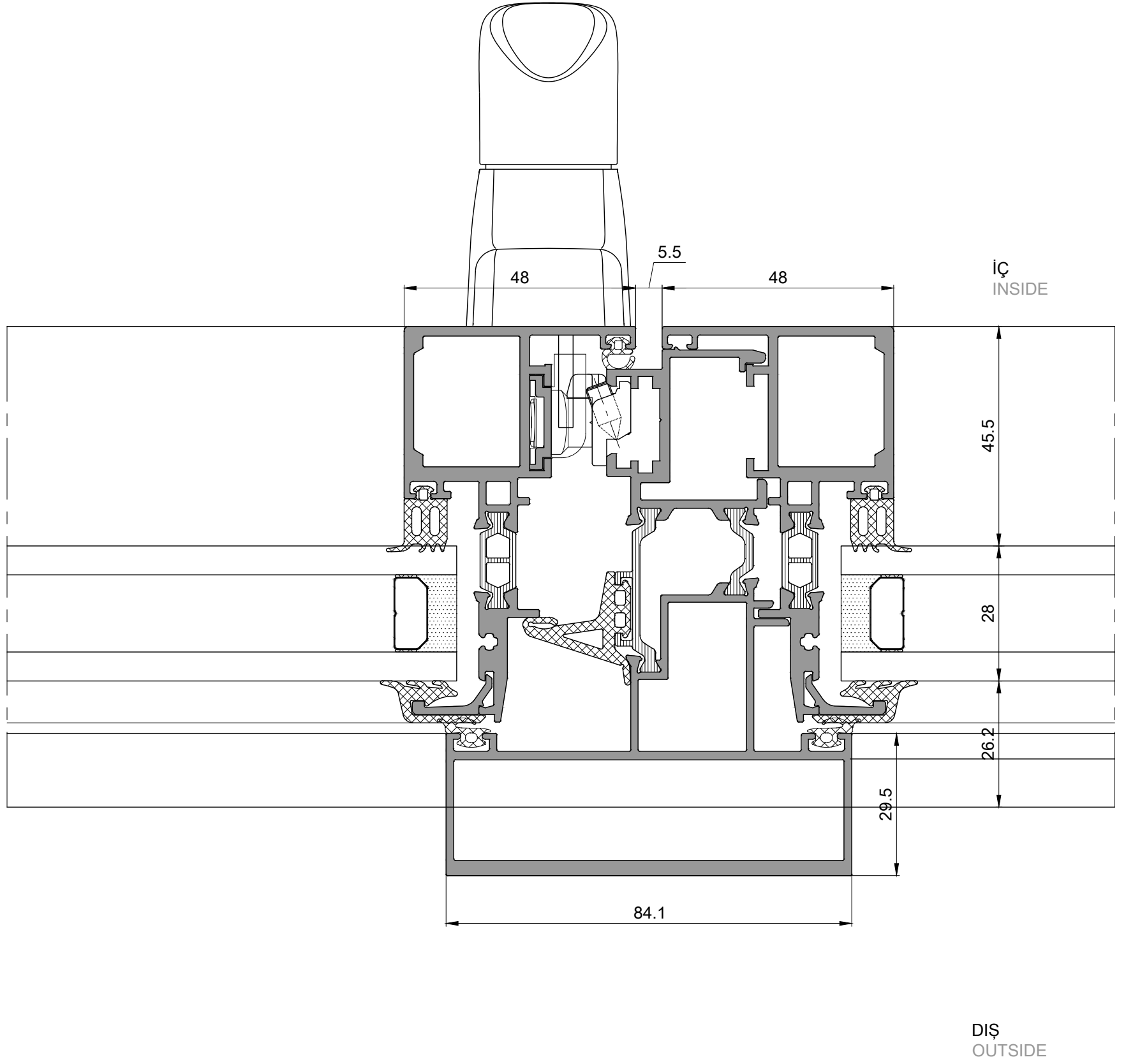
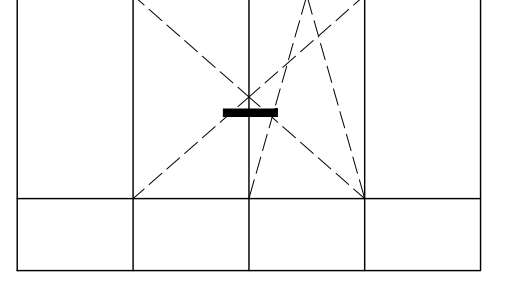

Contalı Gizli Kanat Detayları  
Gasketed Hidden Sash Sections

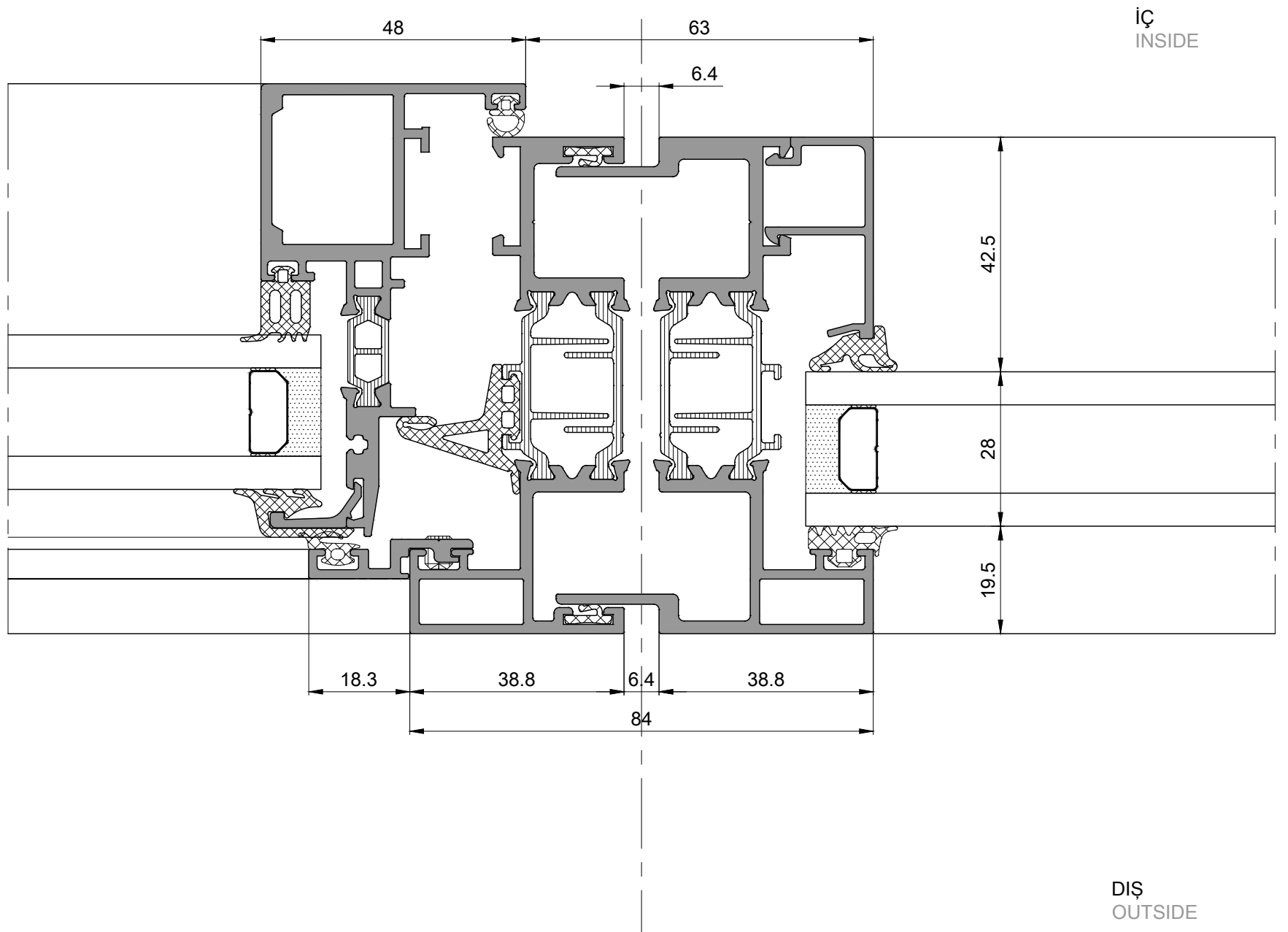
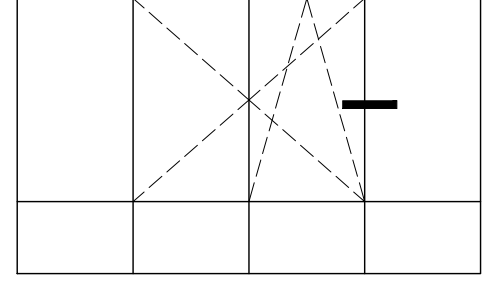



Contalı Gizli Kanat Detayları  
Gasketed Hidden Sash Sections

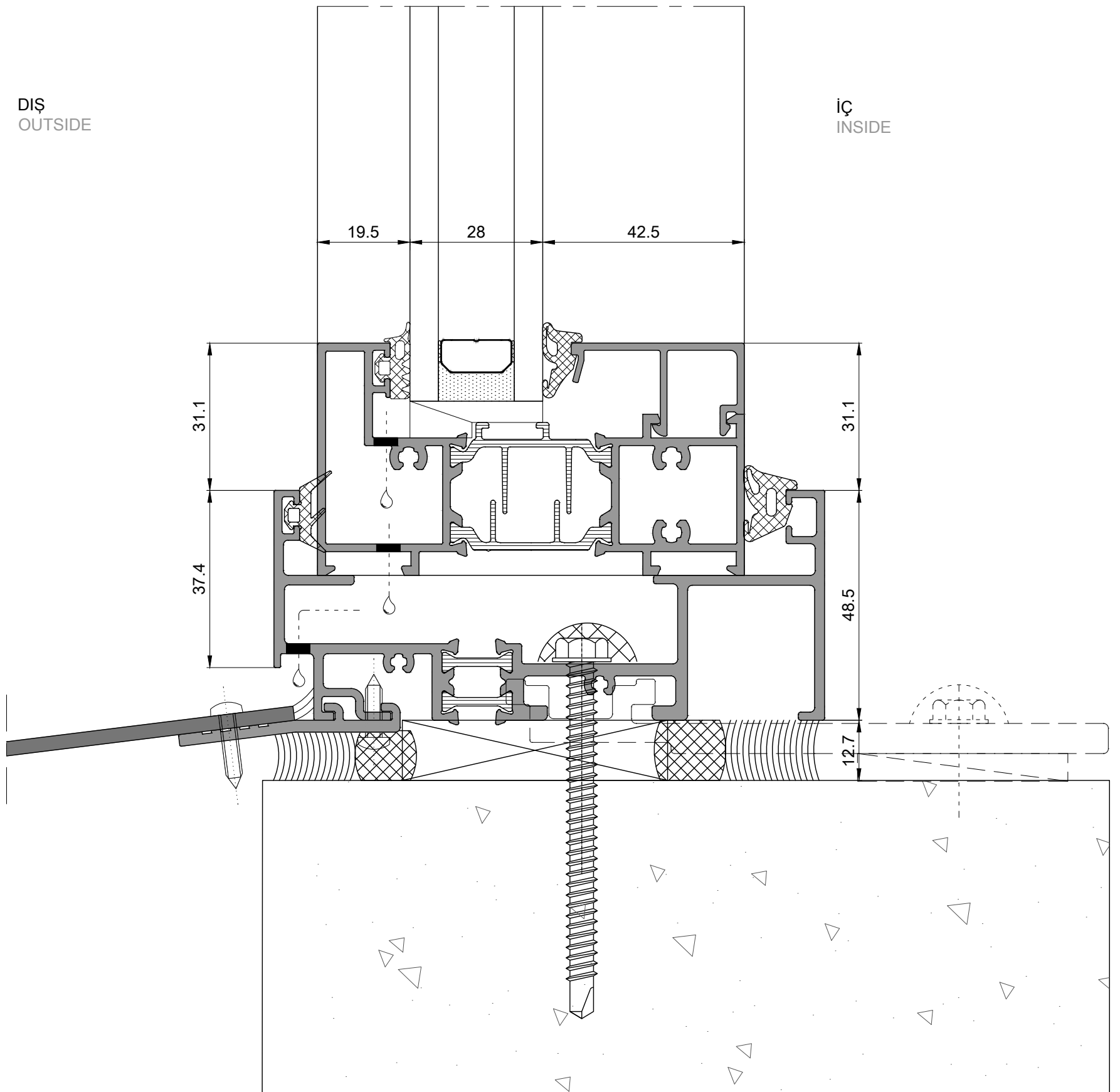
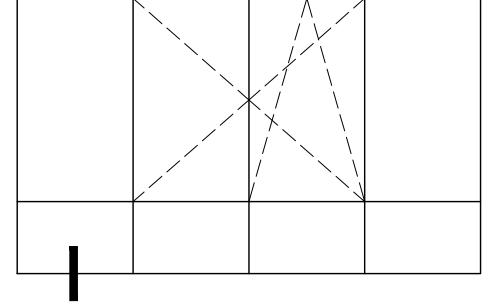

Contalı Gizli Kanat Detayları  
Gasketed Hidden Sash Sections

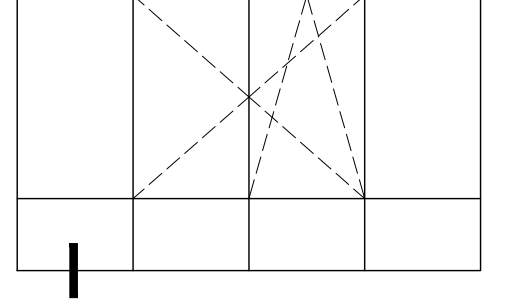

DIŞ  
OUTSIDE

İÇ  
INSIDE

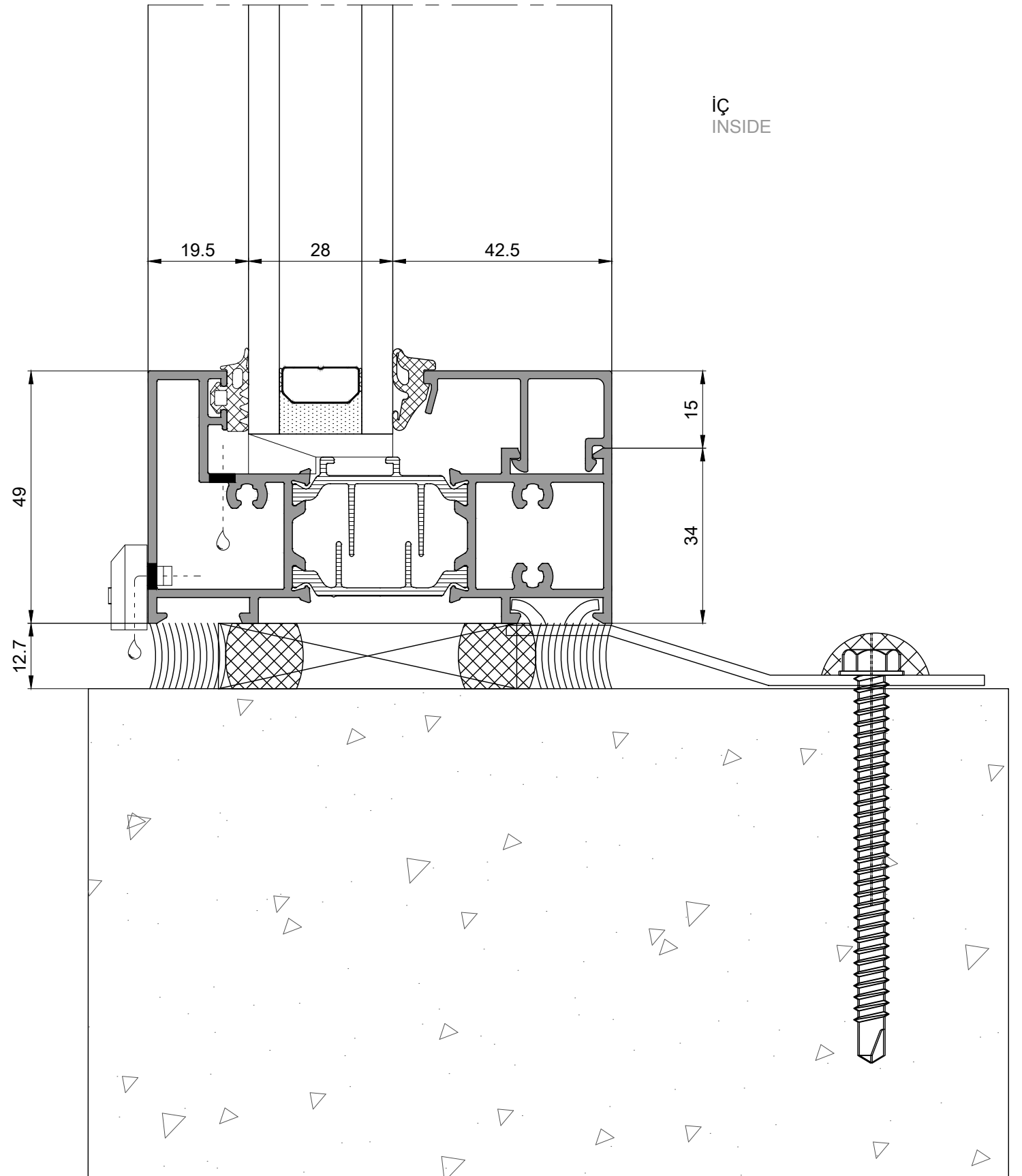

Contalı Gizli Kanat Detayları  
Gasketed Hidden Sash Sections

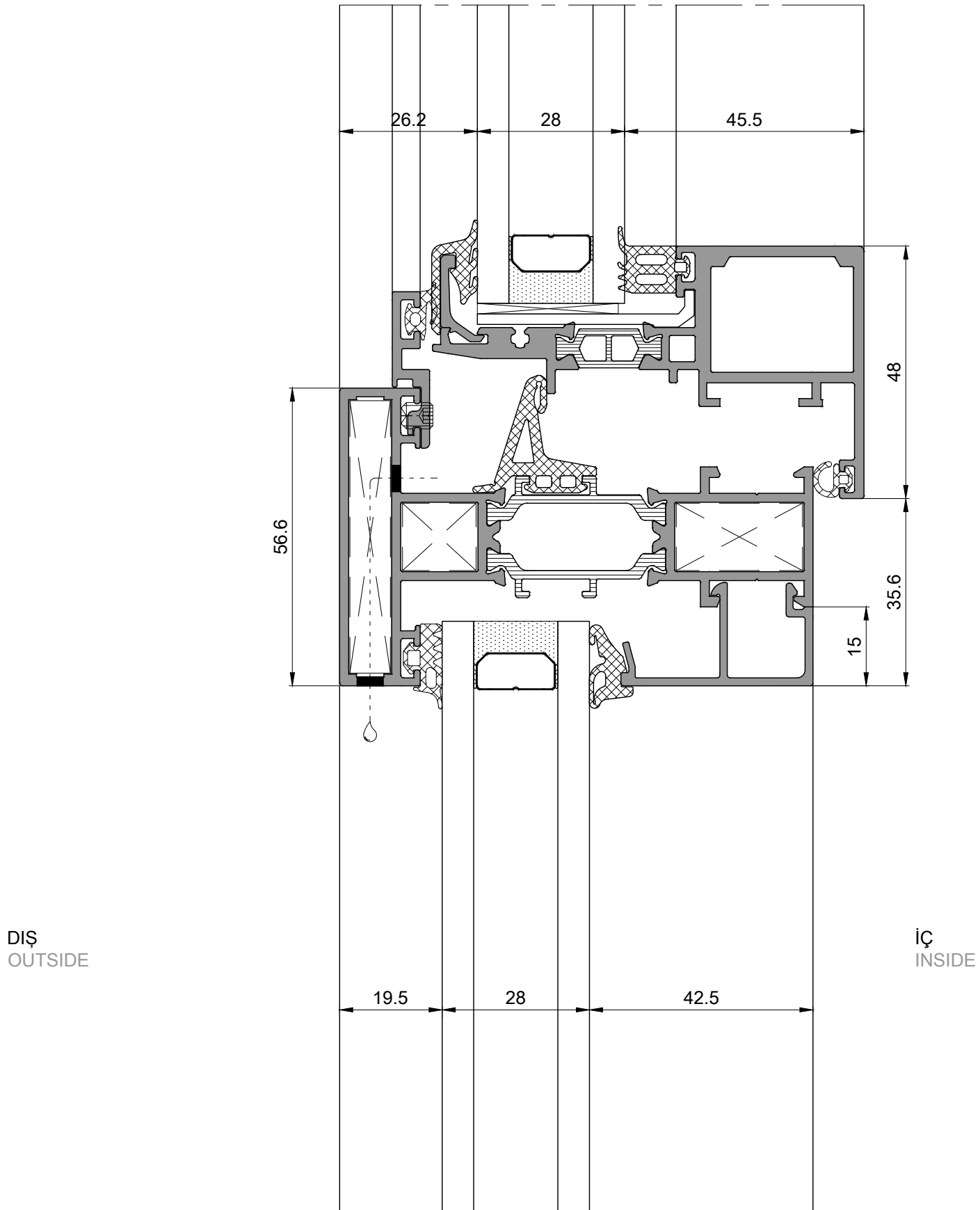
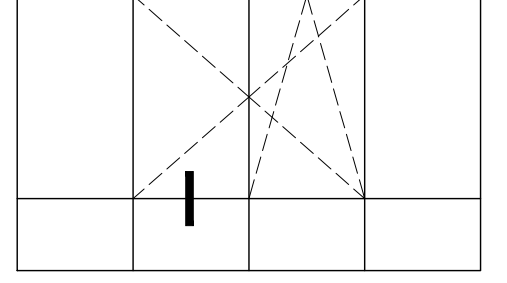

Contalı Gizli Kanat Detayları  
Gasketed Hidden Sash Sections

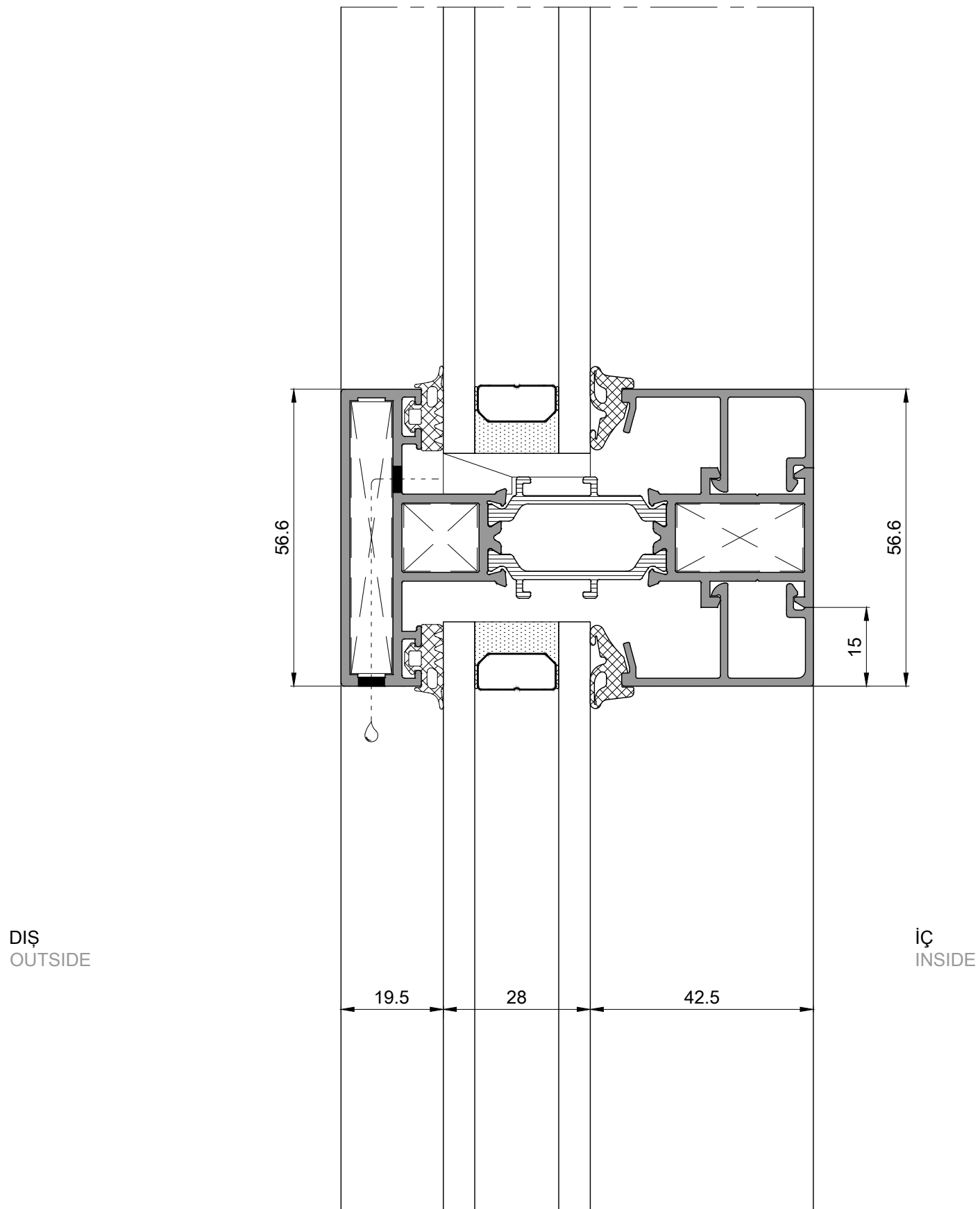
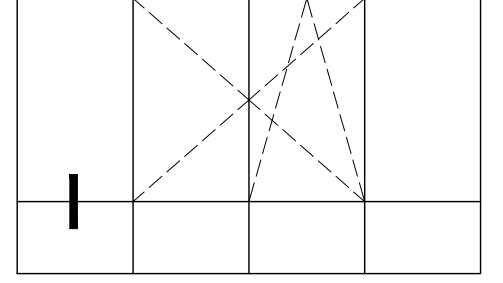

Contalı Gizli Kanat Detayları  
Gasketed Hidden Sash Sections

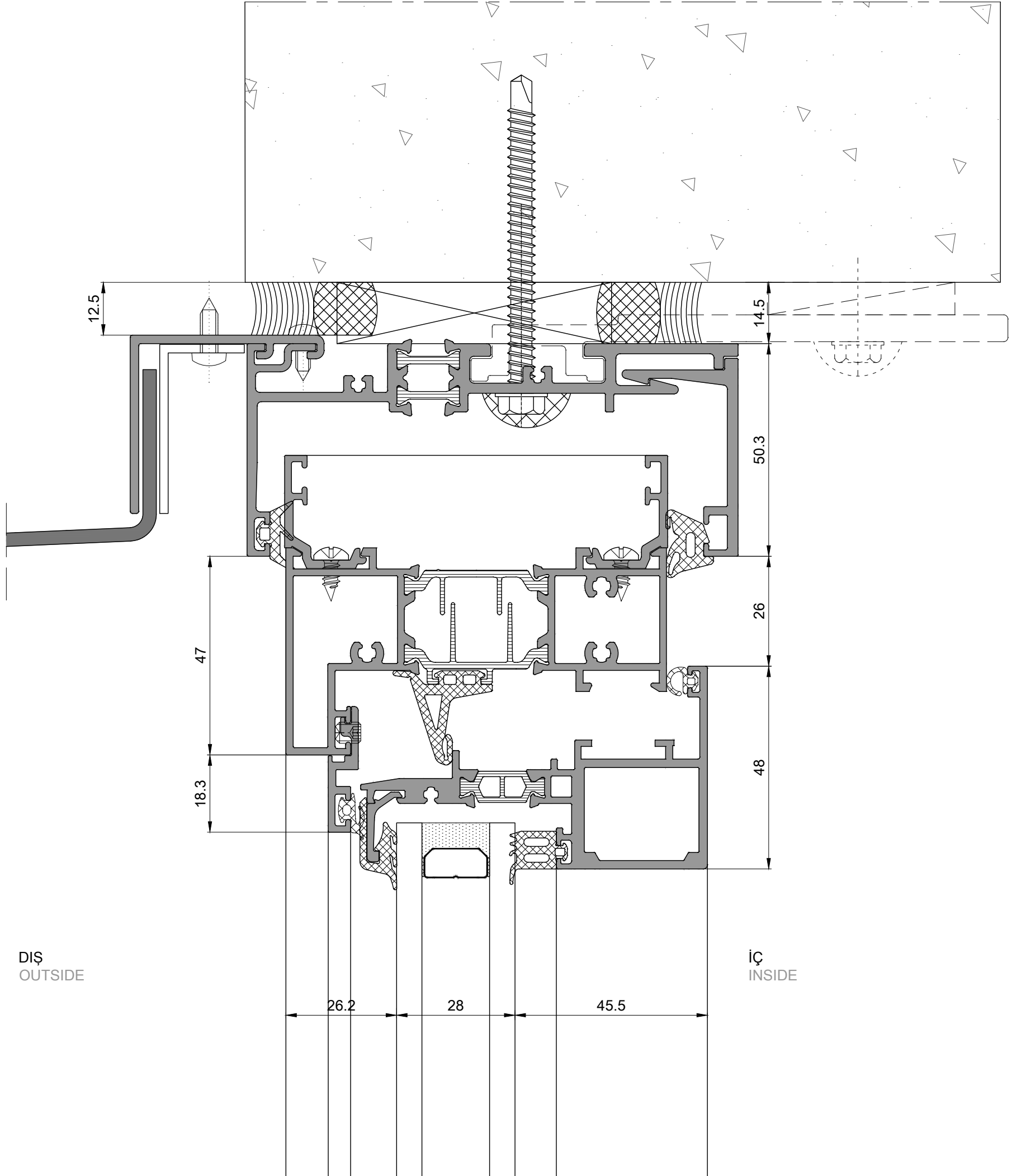
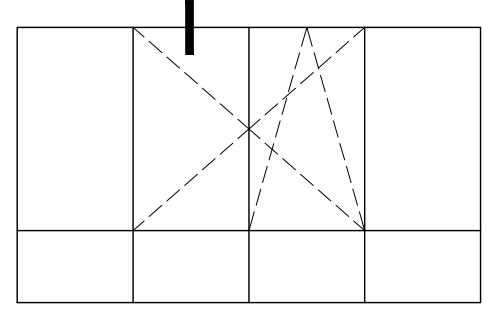

Contalı Gizli Kanat Detayları  
Gasketed Hidden Sash Sections

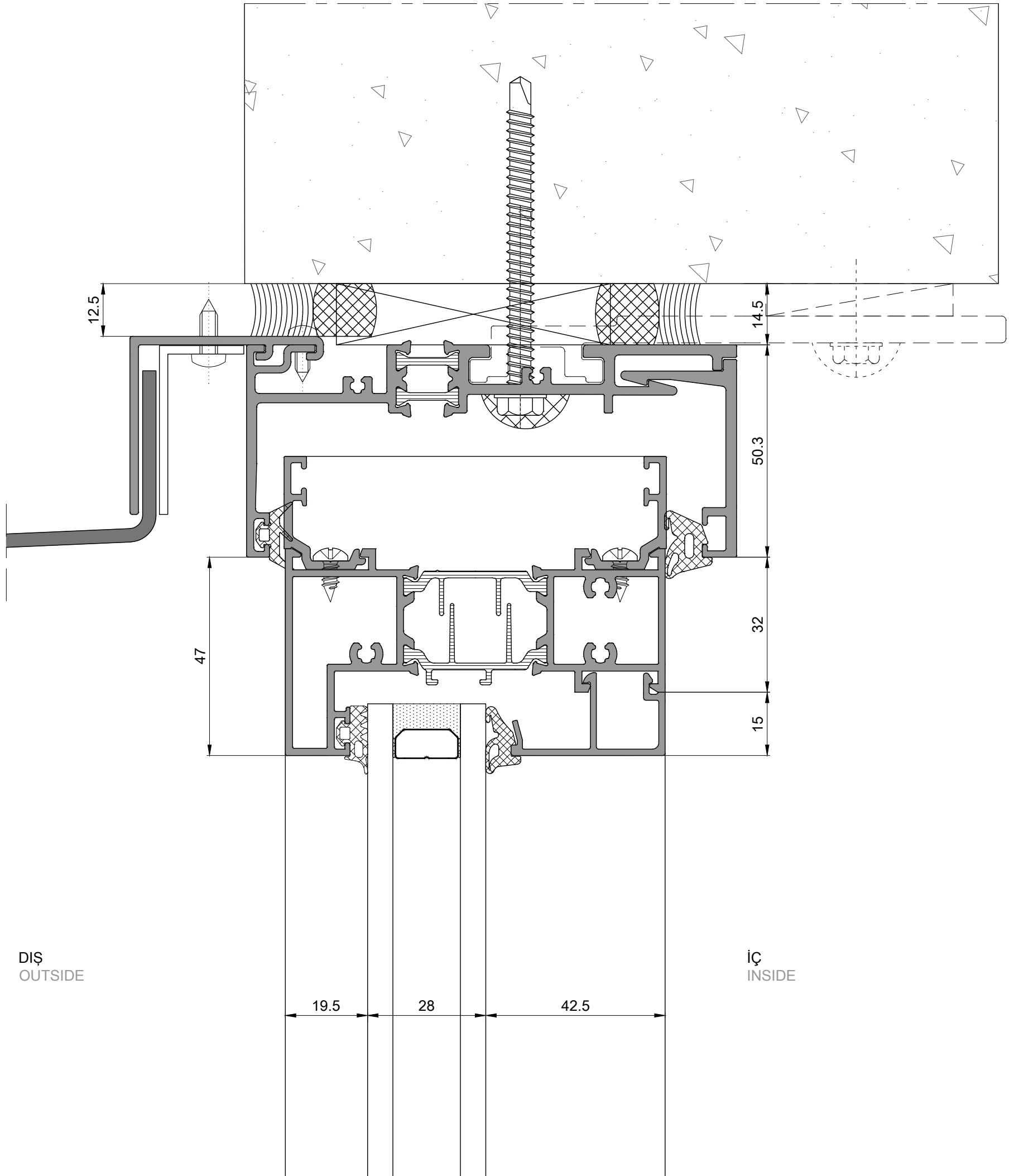
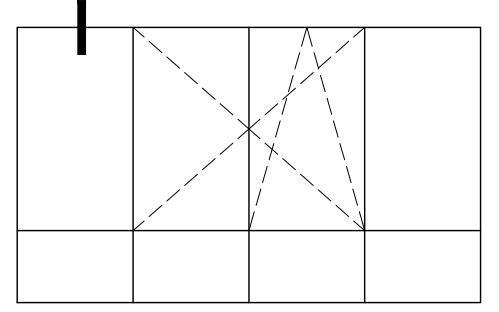

Contalı Gizli Kanat Detayları  
Gasketed Hidden Sash Sections

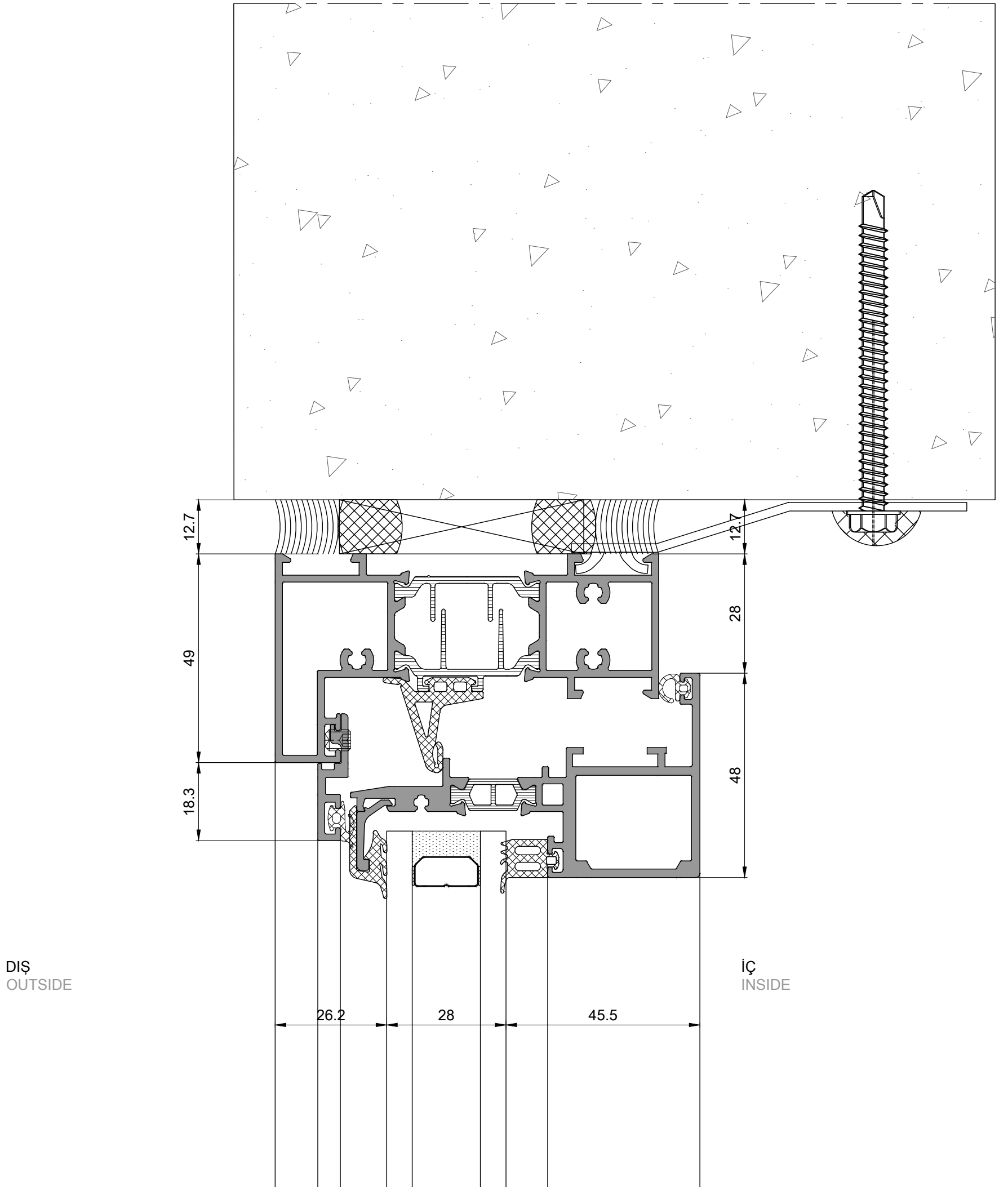
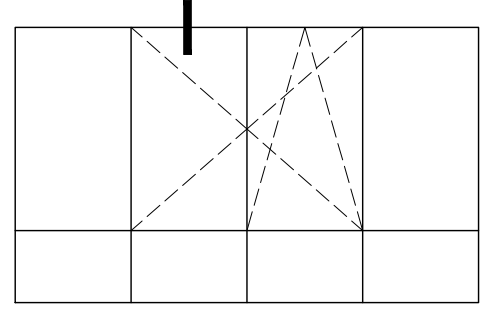

Contalı Gizli Kanat Detayları  
Gasketed Hidden Sash Sections

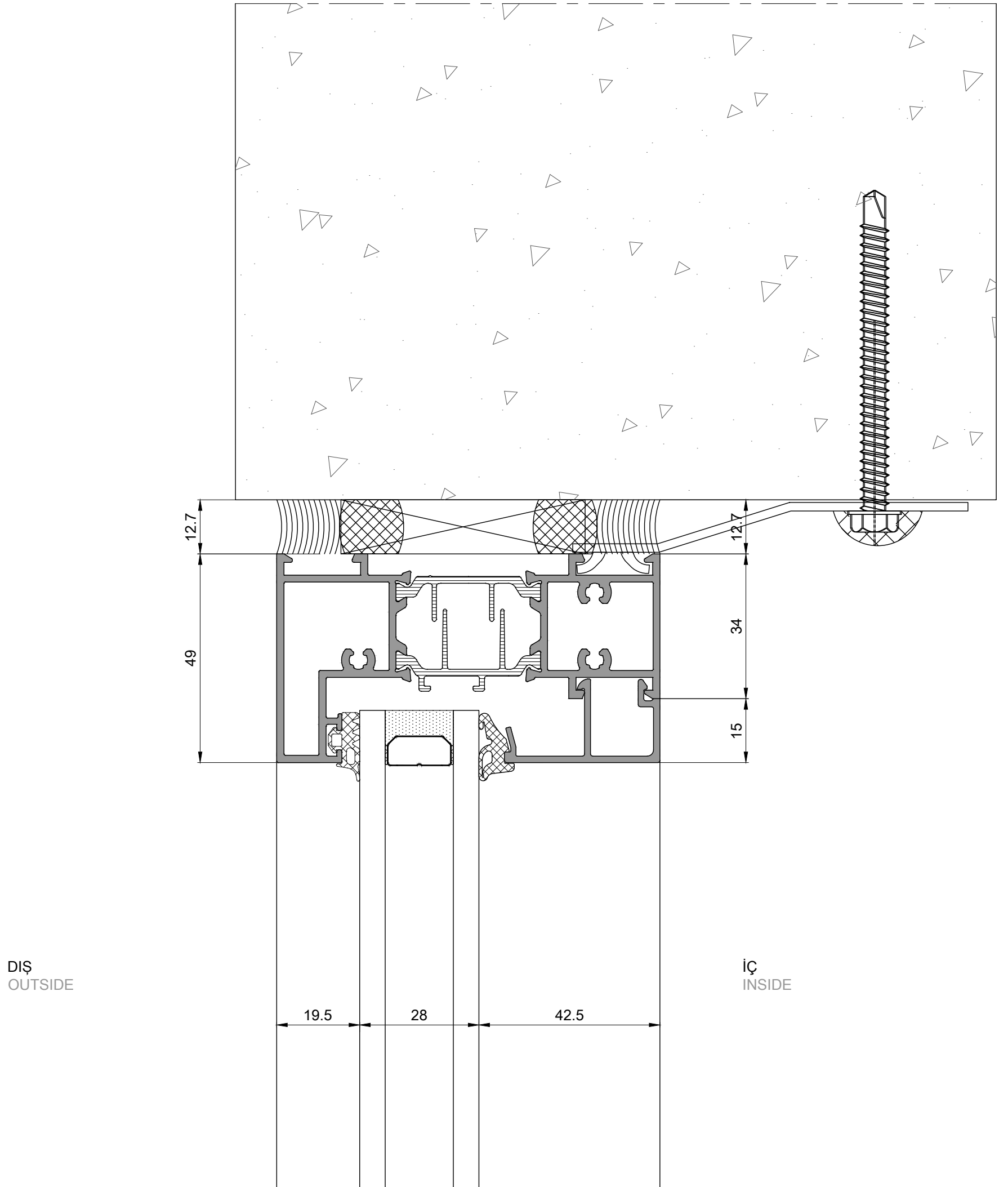
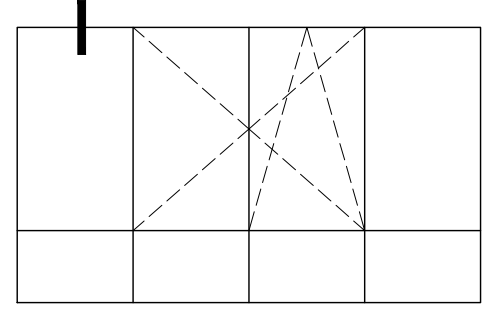



Bondingli Gizli Kanat Detayları  
Structural Siliconed Hidden Sash Sections

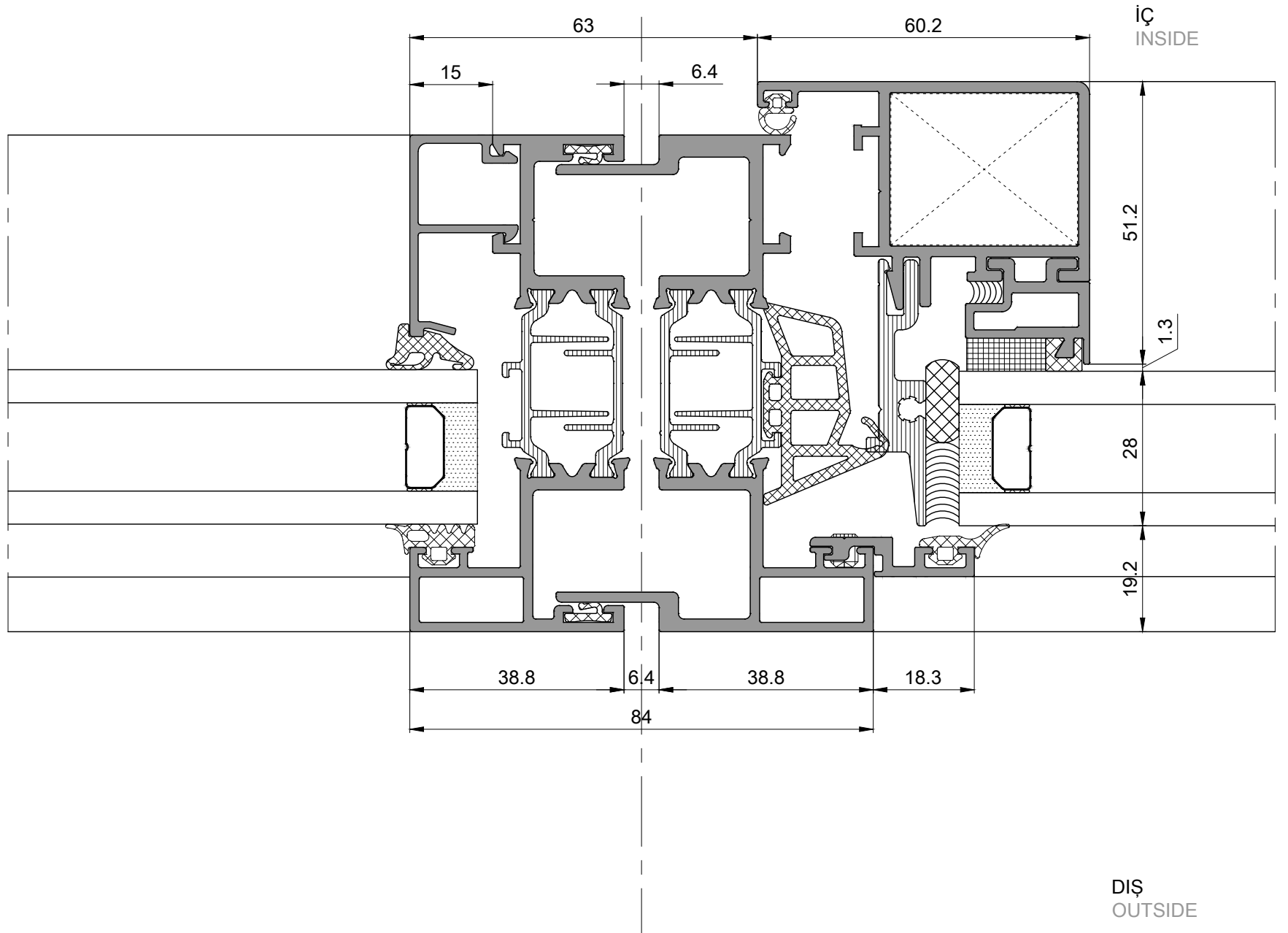
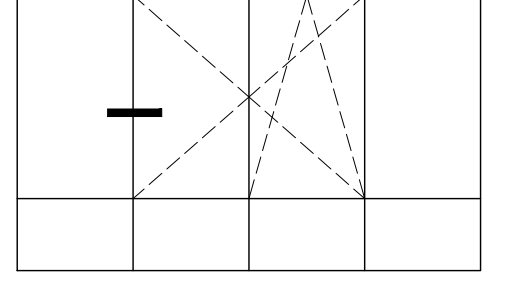

Bondingli Gizli Kanat Detayları  
Structural Siliconed Hidden Sash Sections

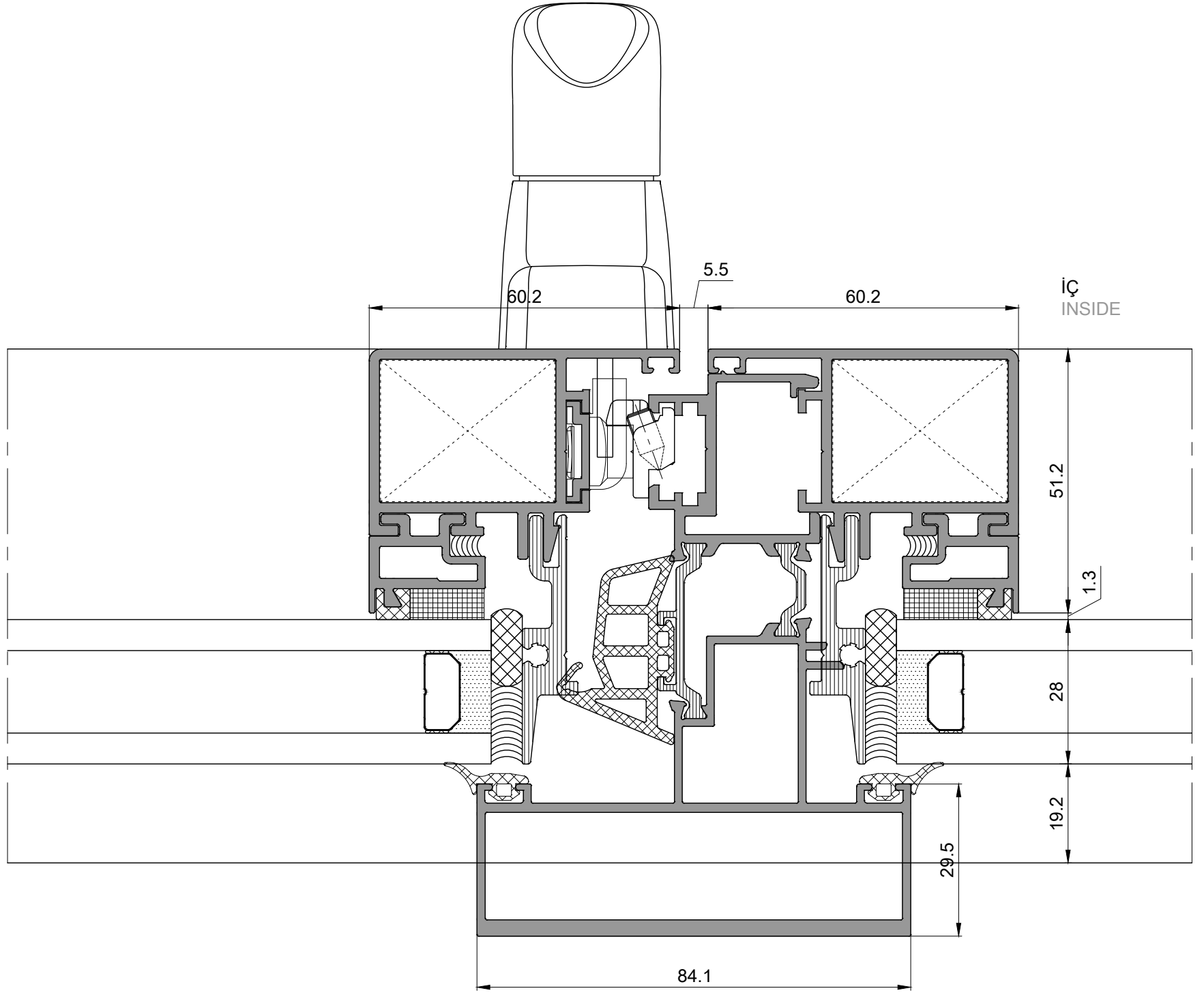
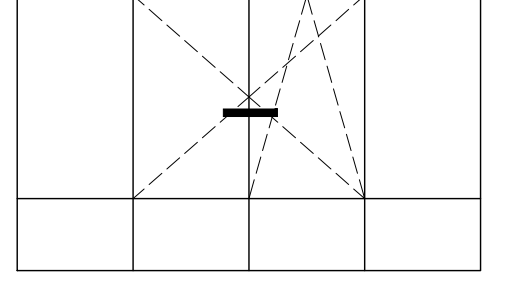

DIŞ  
OUTSIDE

**Bondingli Gizli Kanat Detayları**  
Structural Siliconed Hidden Sash Sections

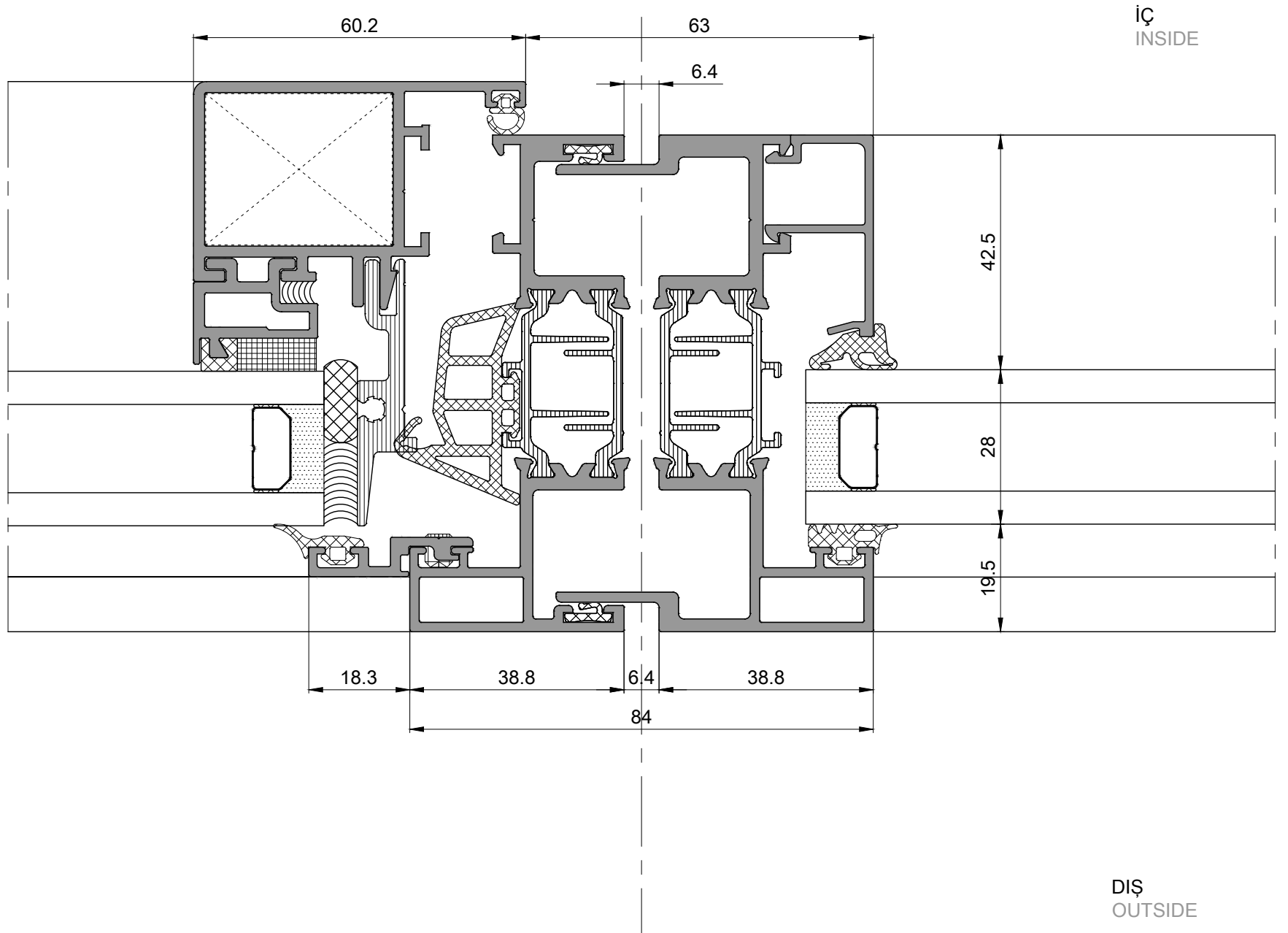
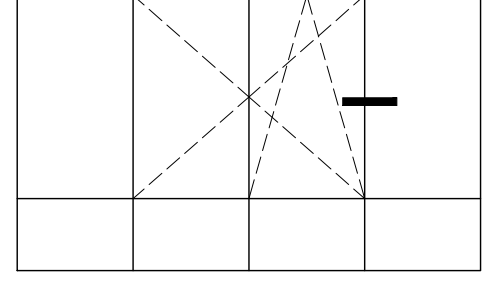

**Bondingli Gizli Kanat Detayları**  
Structural Siliconed Hidden Sash Sections

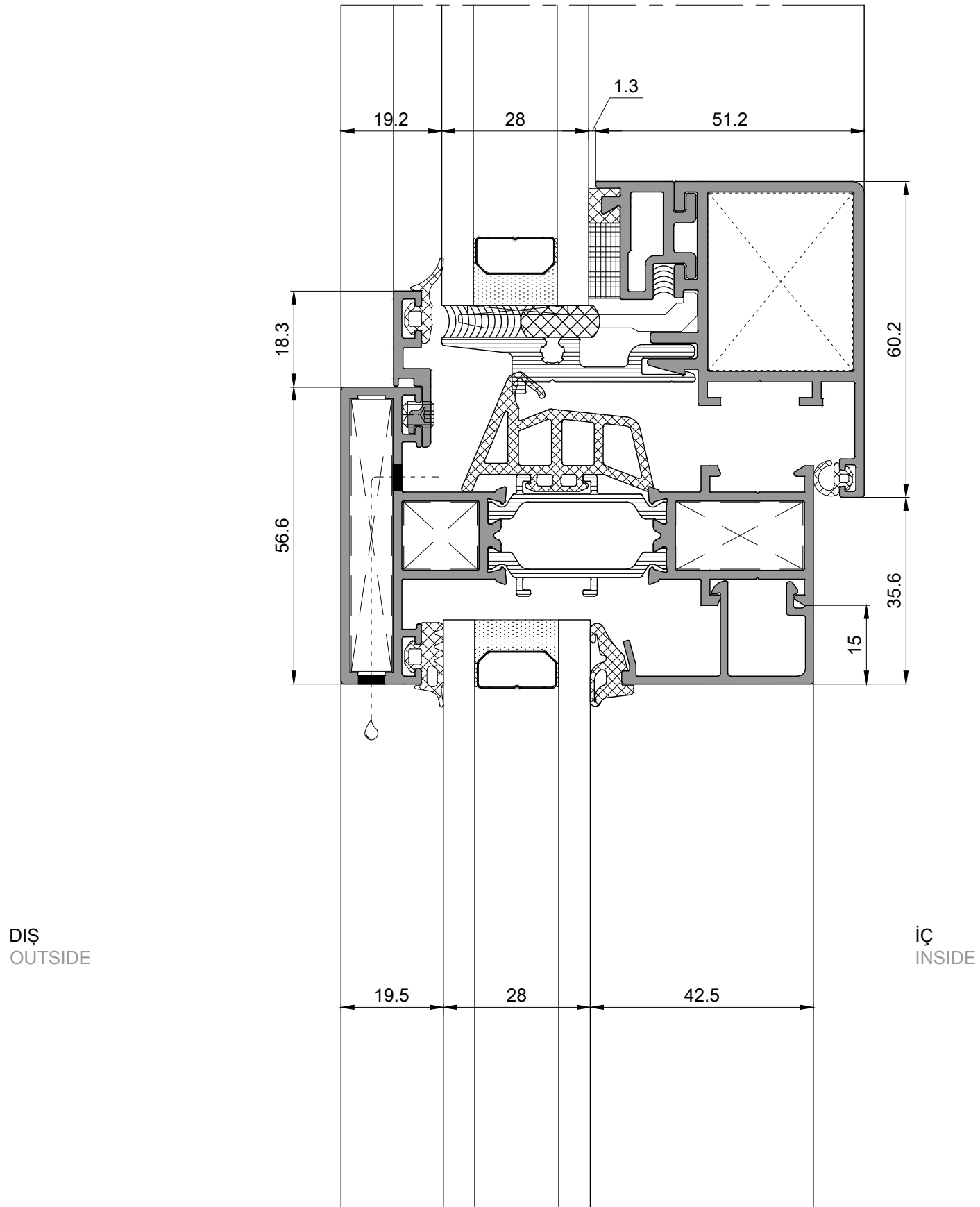
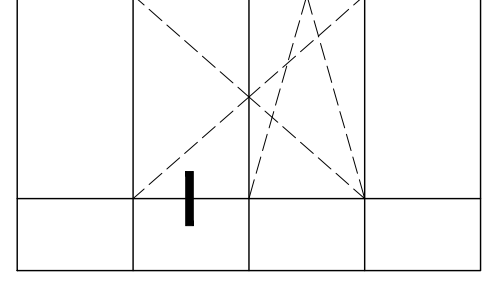

**Bondingli Gizli Kanat Detayları**  
Structural Siliconed Hidden Sash Sections

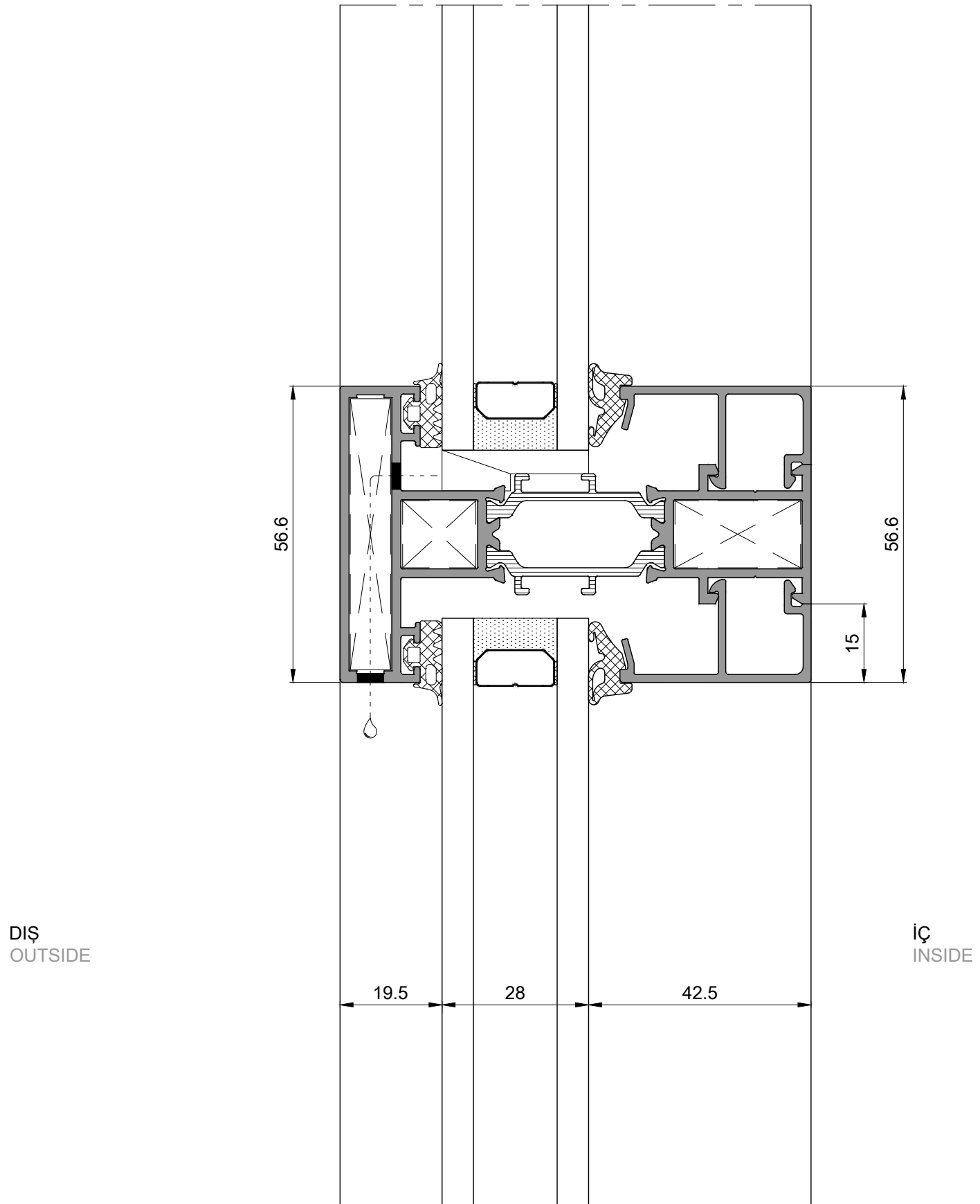
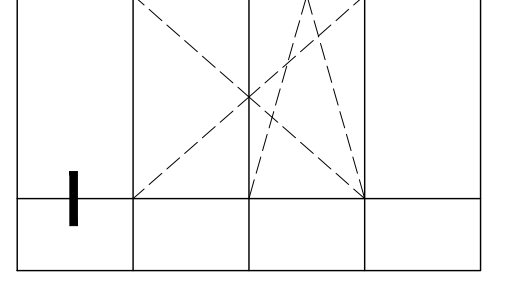

**Bondingli Gizli Kanat Detayları**  
Structural Siliconed Hidden Sash Sections

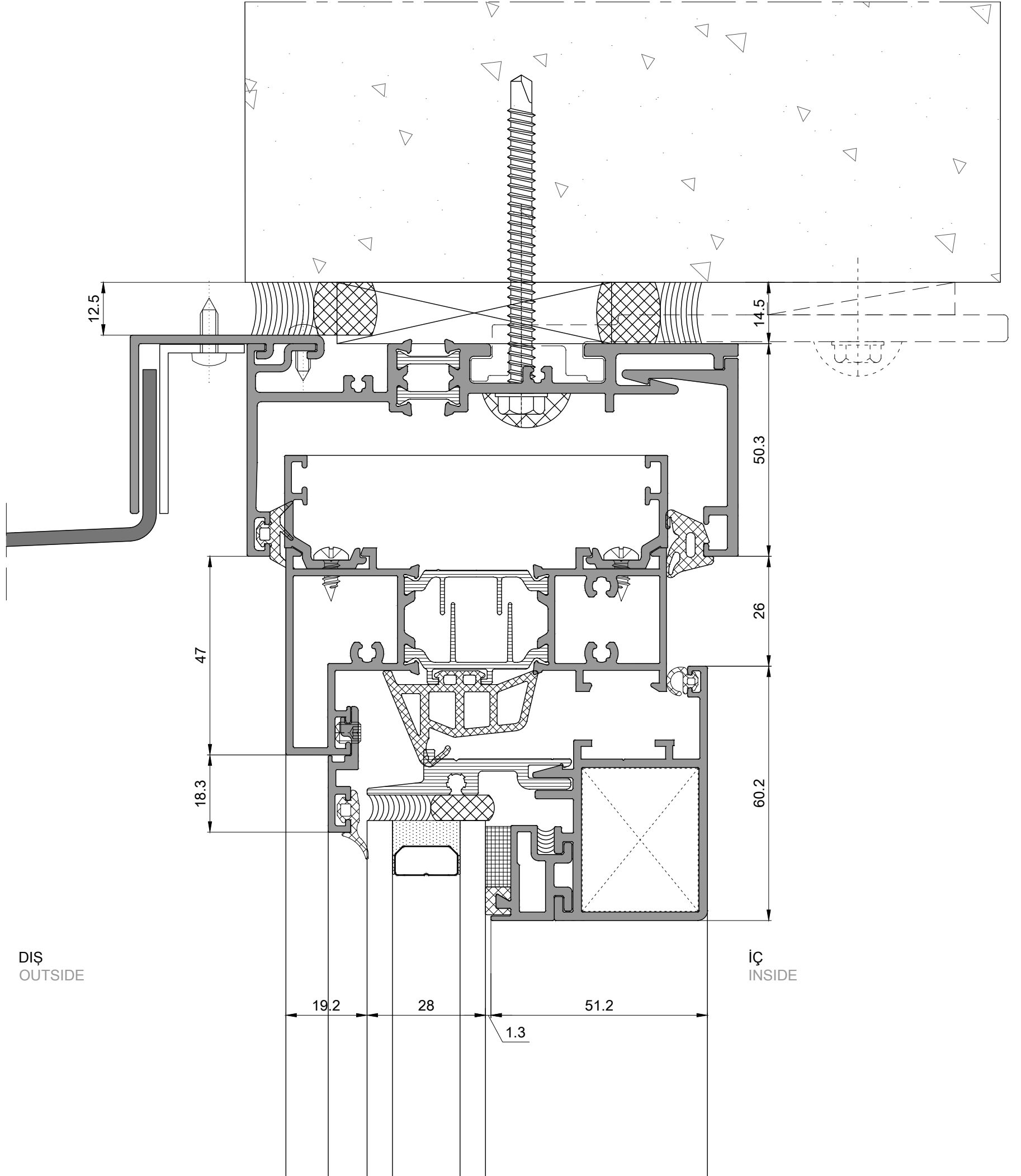
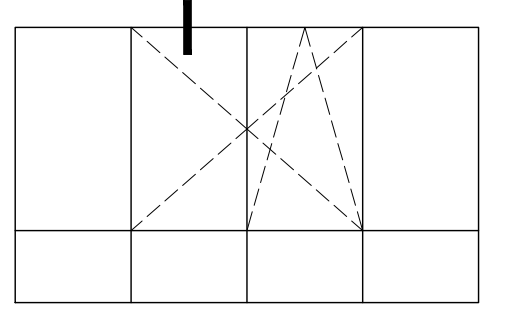

**Bondingli Gizli Kanat Detayları**  
Structural Siliconed Hidden Sash Sections

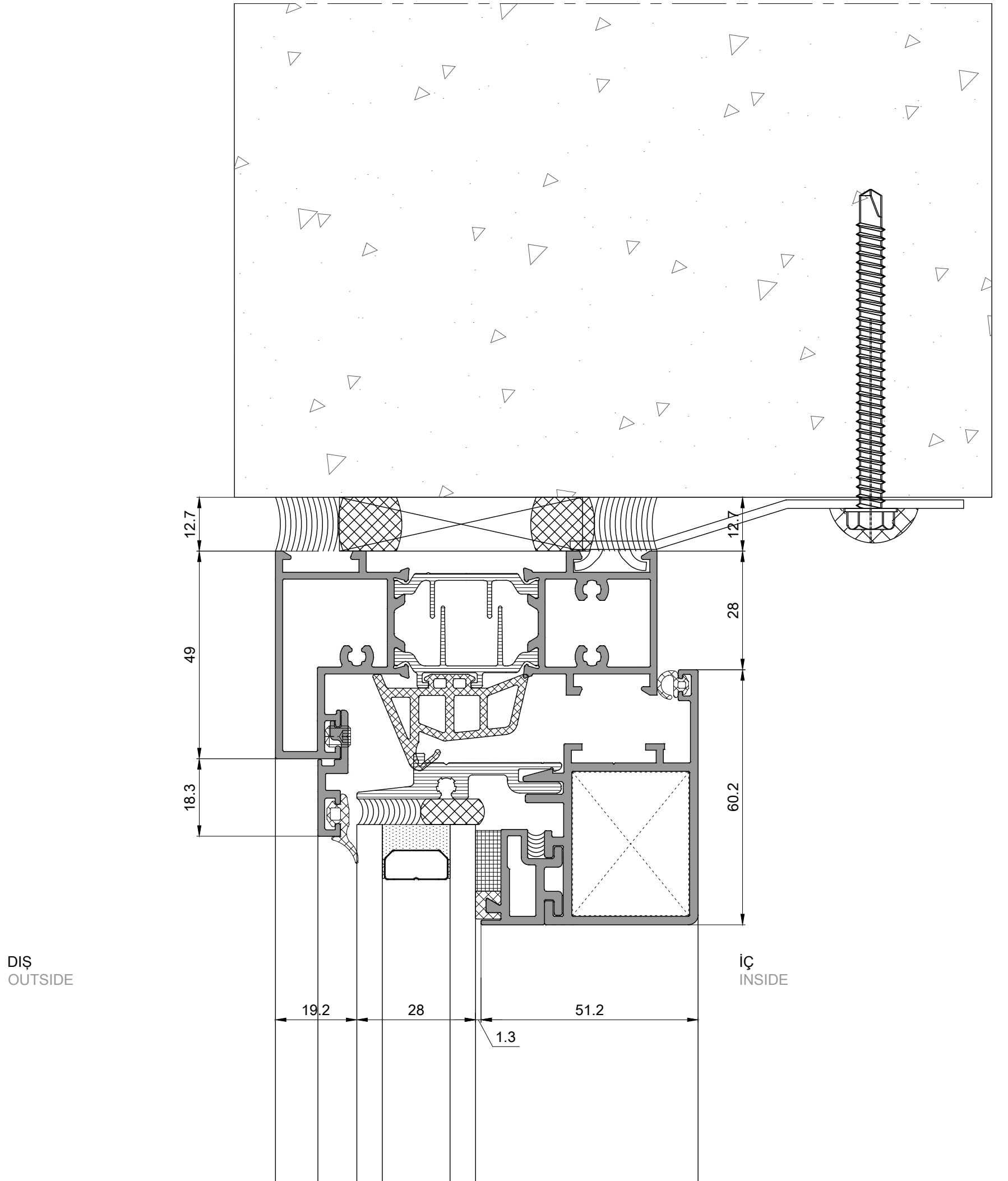
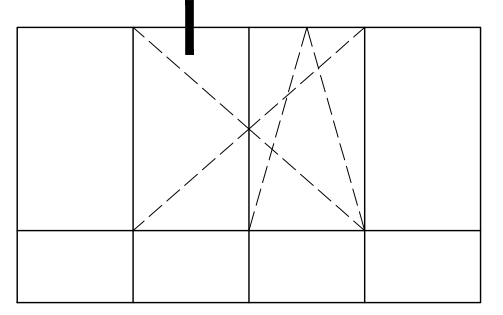

**Klasik İçe Açılır Pencere Detayları**  
Classic Inward Opening Window Sections

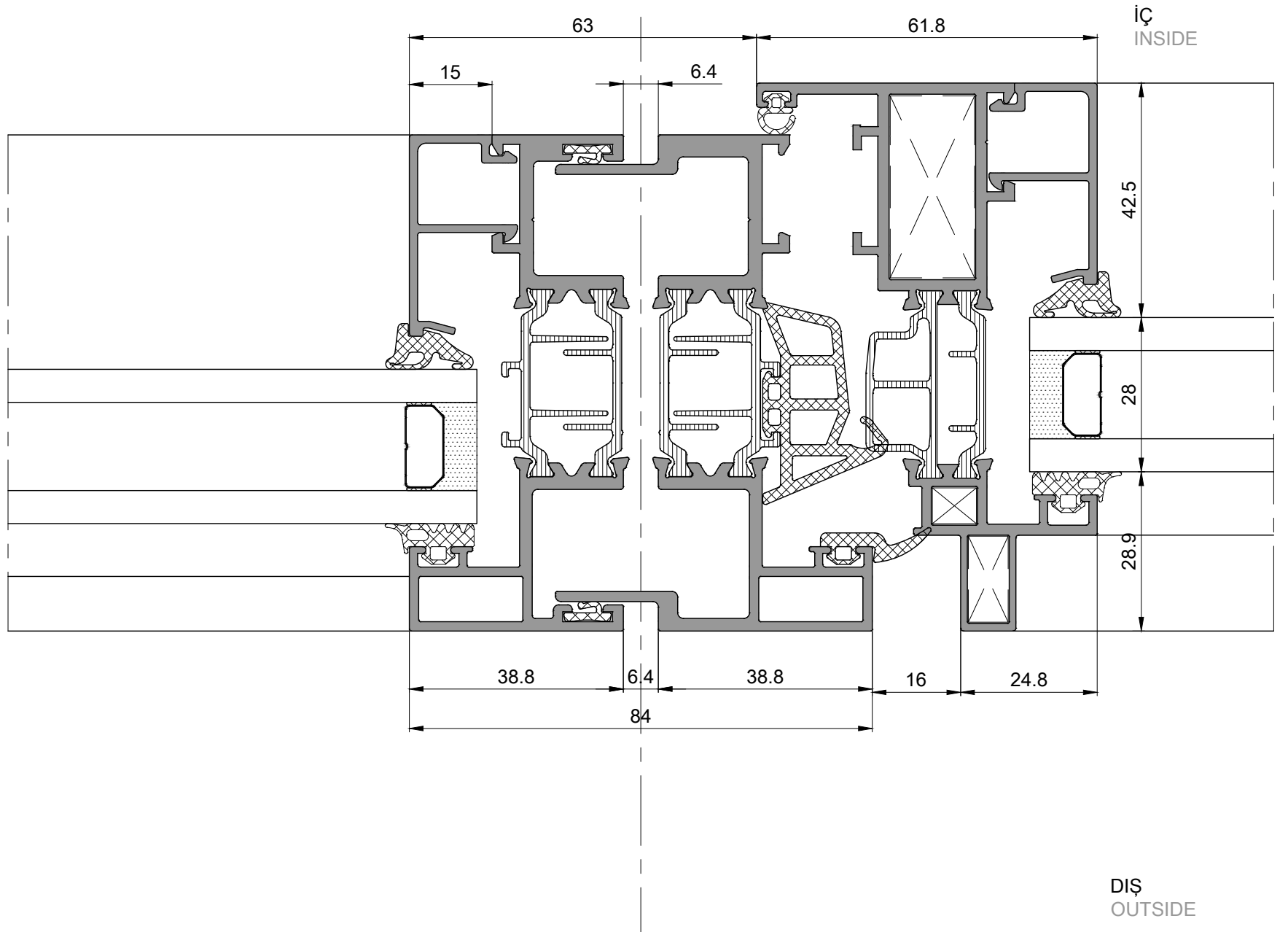
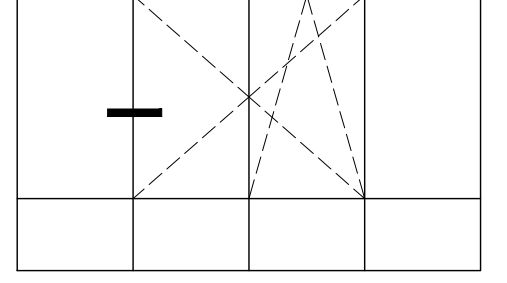



**Klasik İçe Açılır Pencere Detayları**  
Classic Inward Opening Window Sections

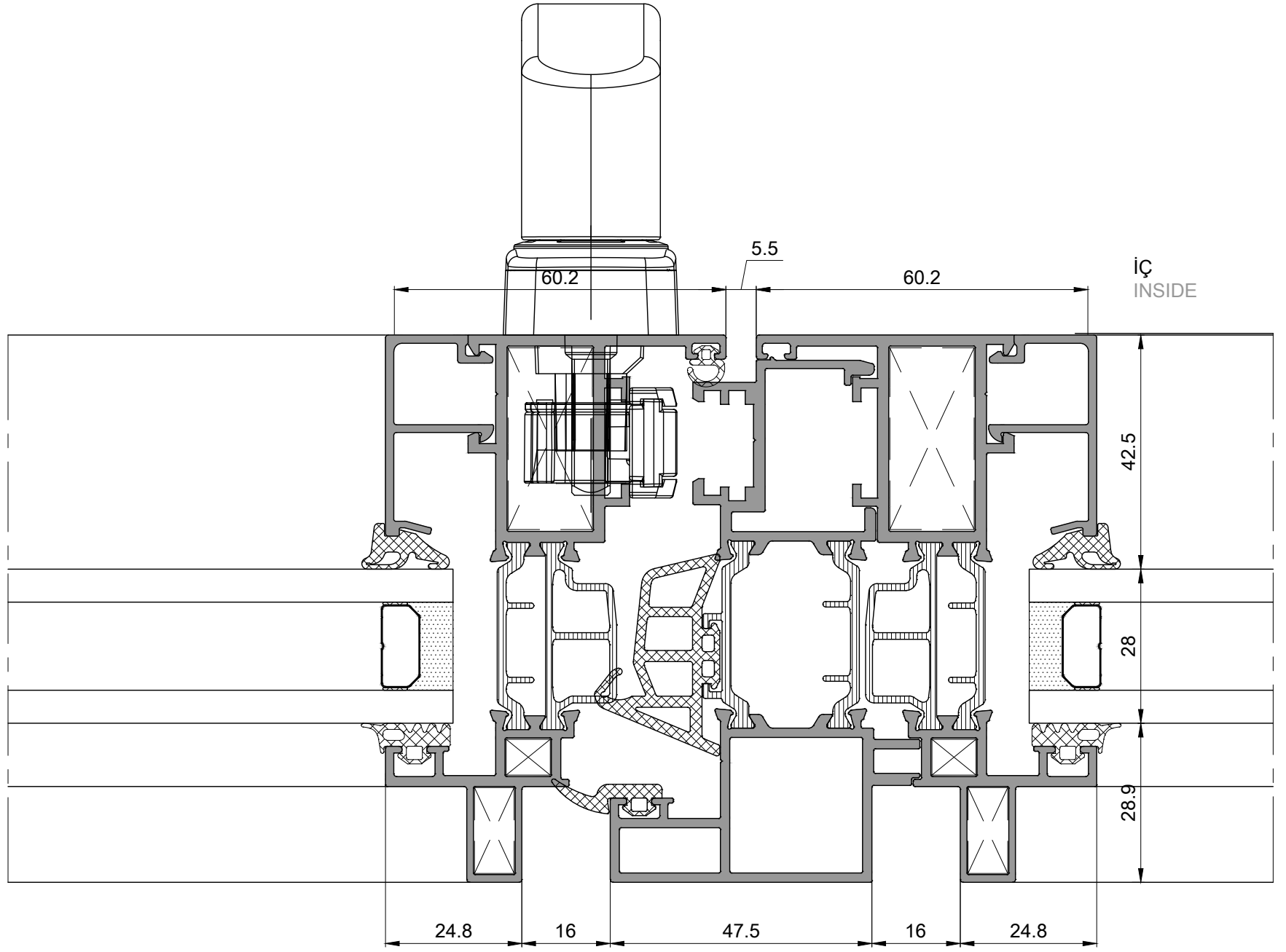
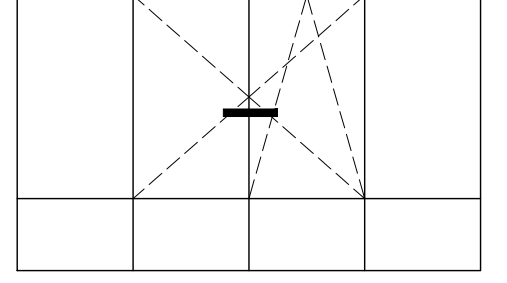

DIŞ  
OUTSIDE

**Klasik İçe Açılır Pencere Detayları**  
Classic Inward Opening Window Sections

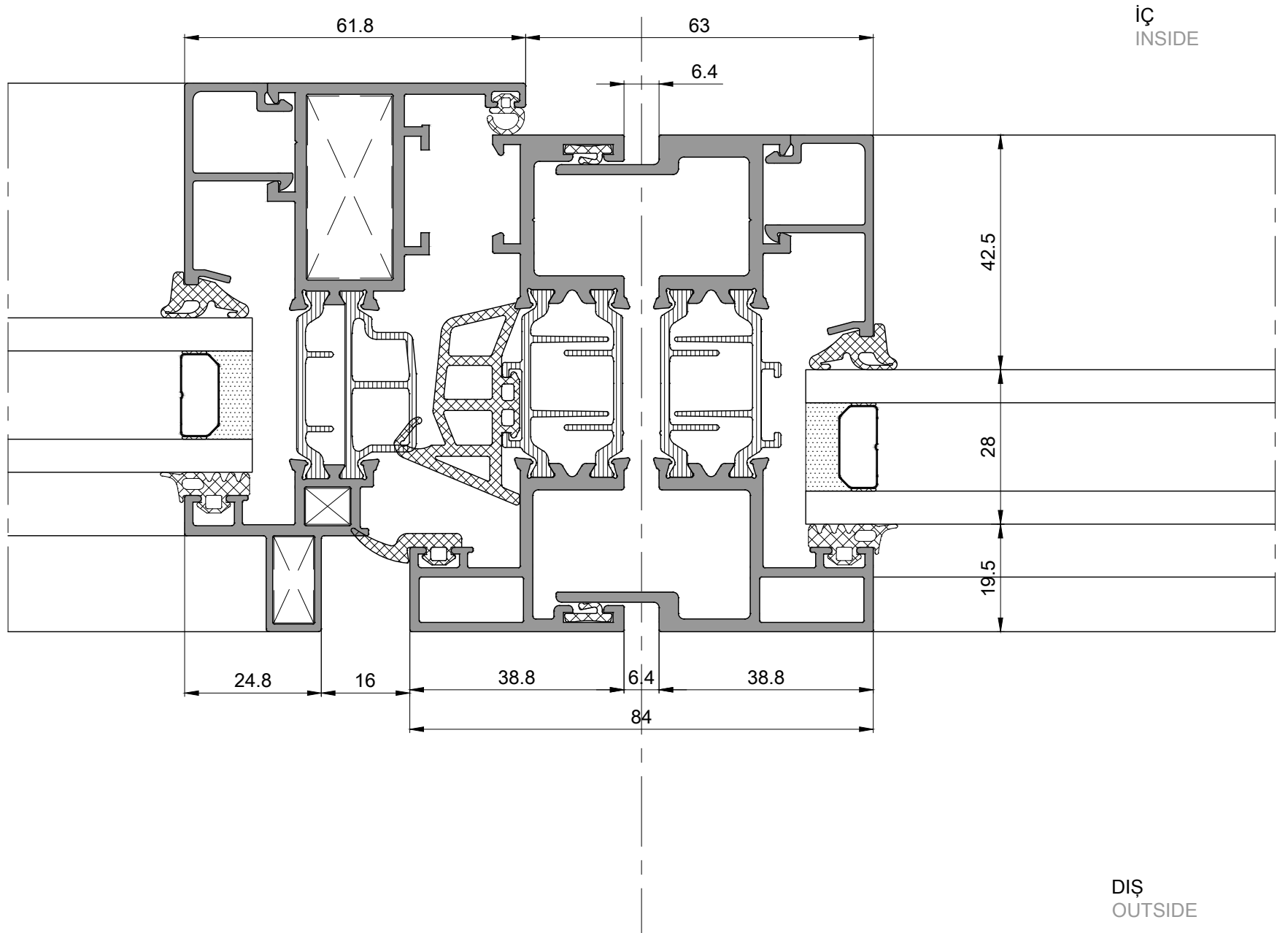
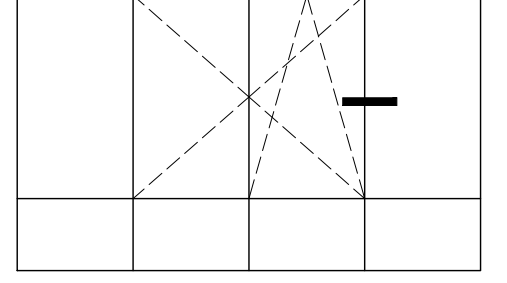

**Klasik İçe Açılır Pencere Detayları**  
Classic Inward Opening Window Sections

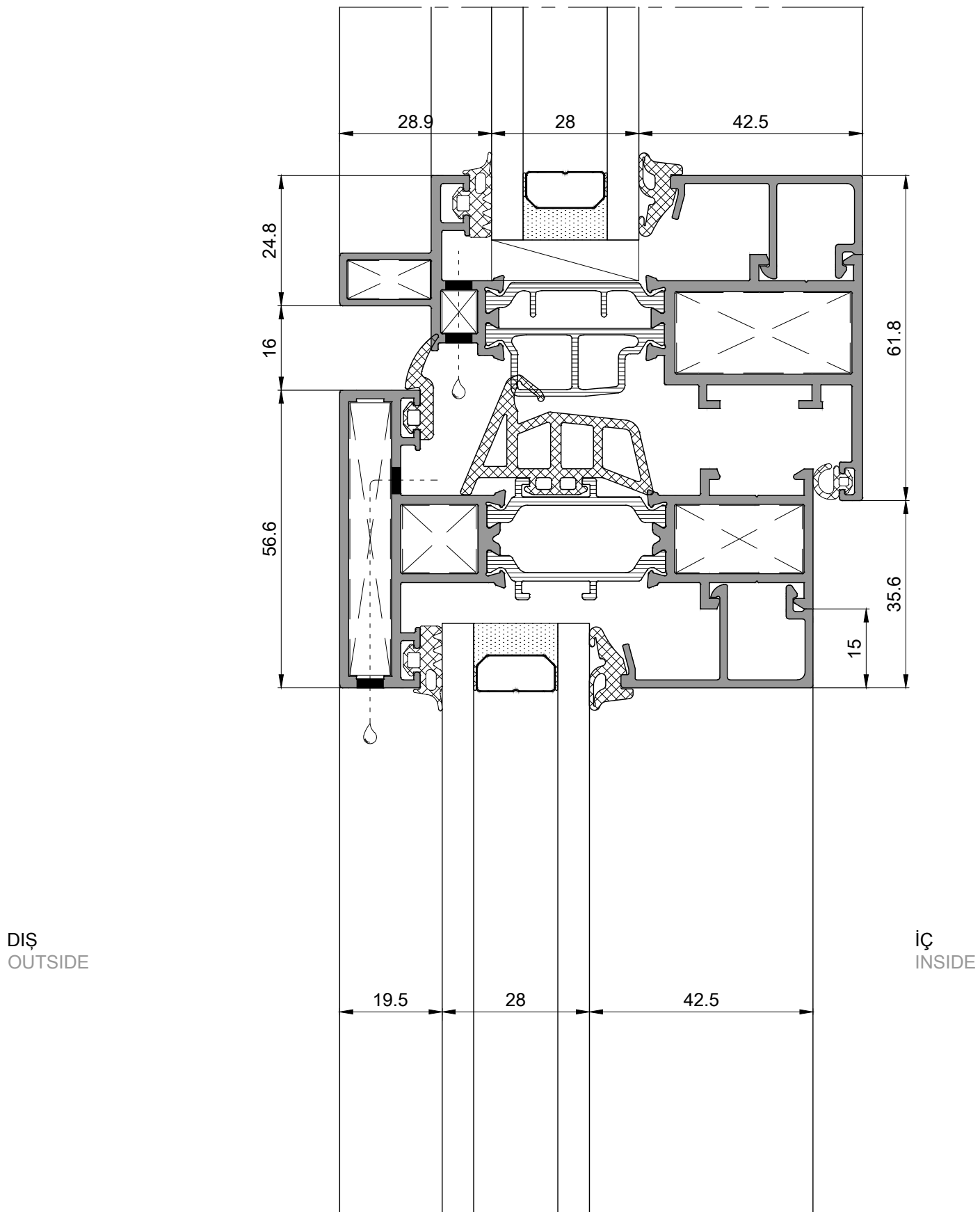
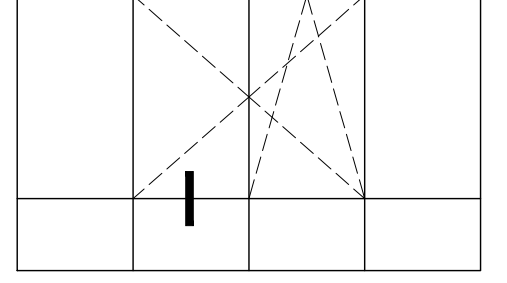

**Klasik İe Aılır Pencere Detayları**  
Classic Inward Opening Window Sections

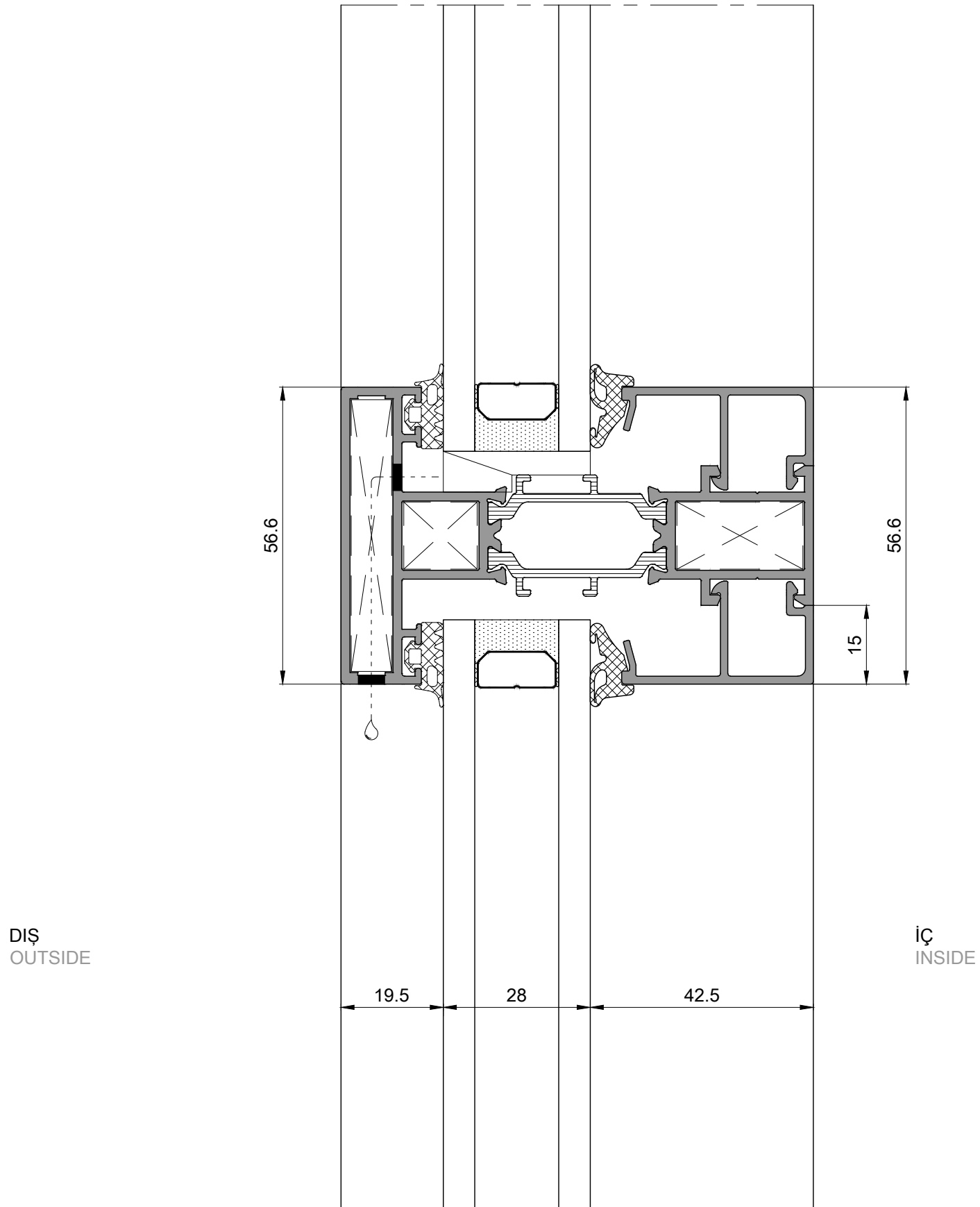
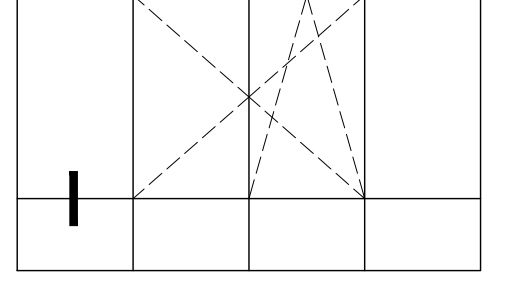

**Klasik İçe Açılır Pencere Detayları**  
Classic Inward Opening Window Sections

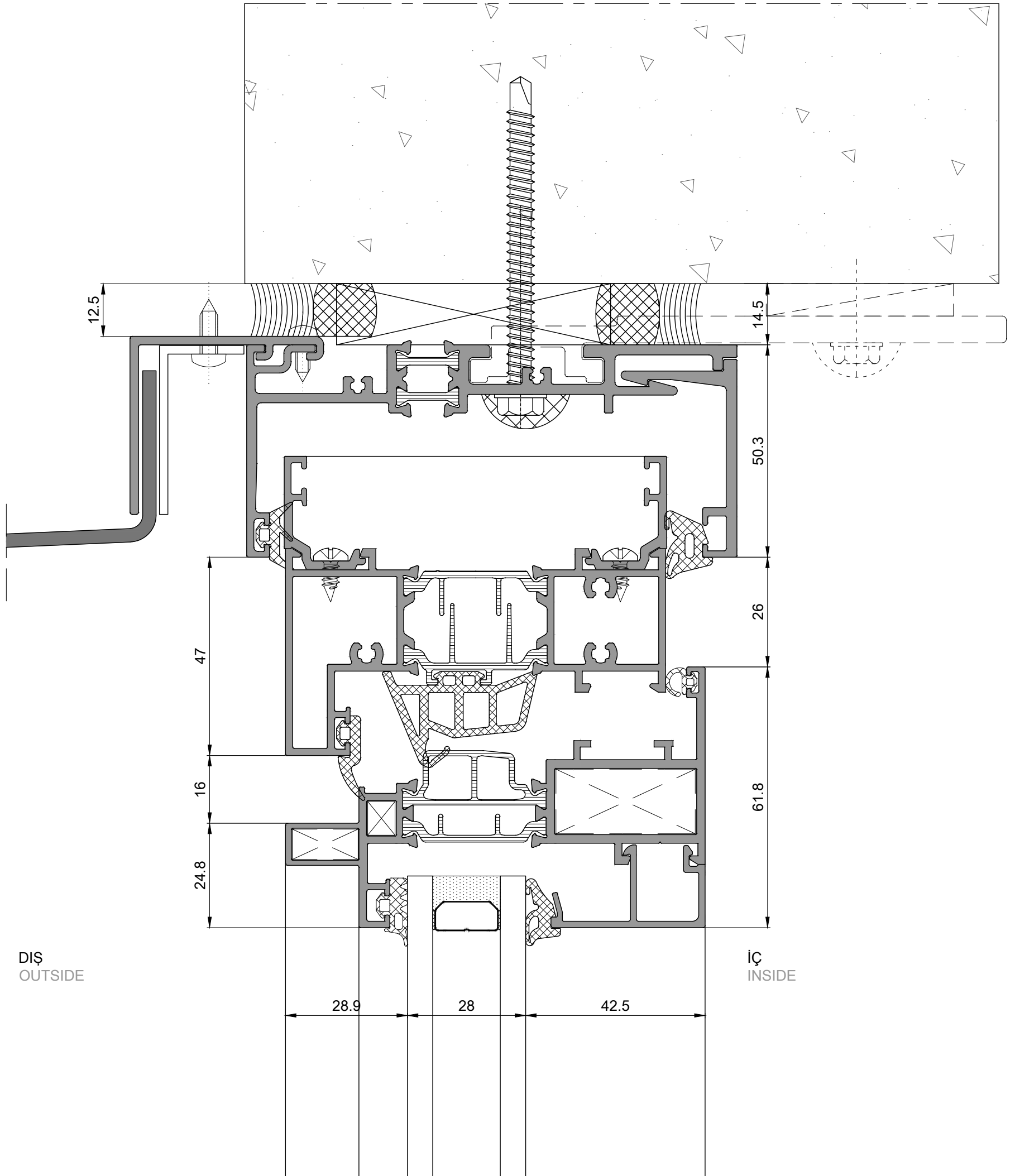
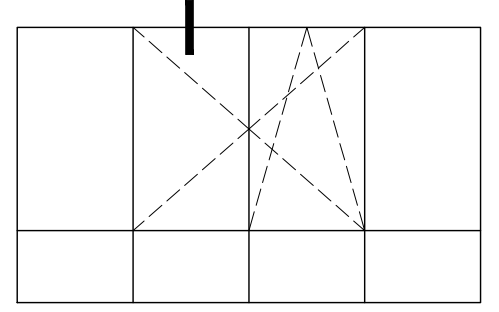

**Klasik İe Açılır Pencere Detayları**  
Classic Inward Opening Window Sections

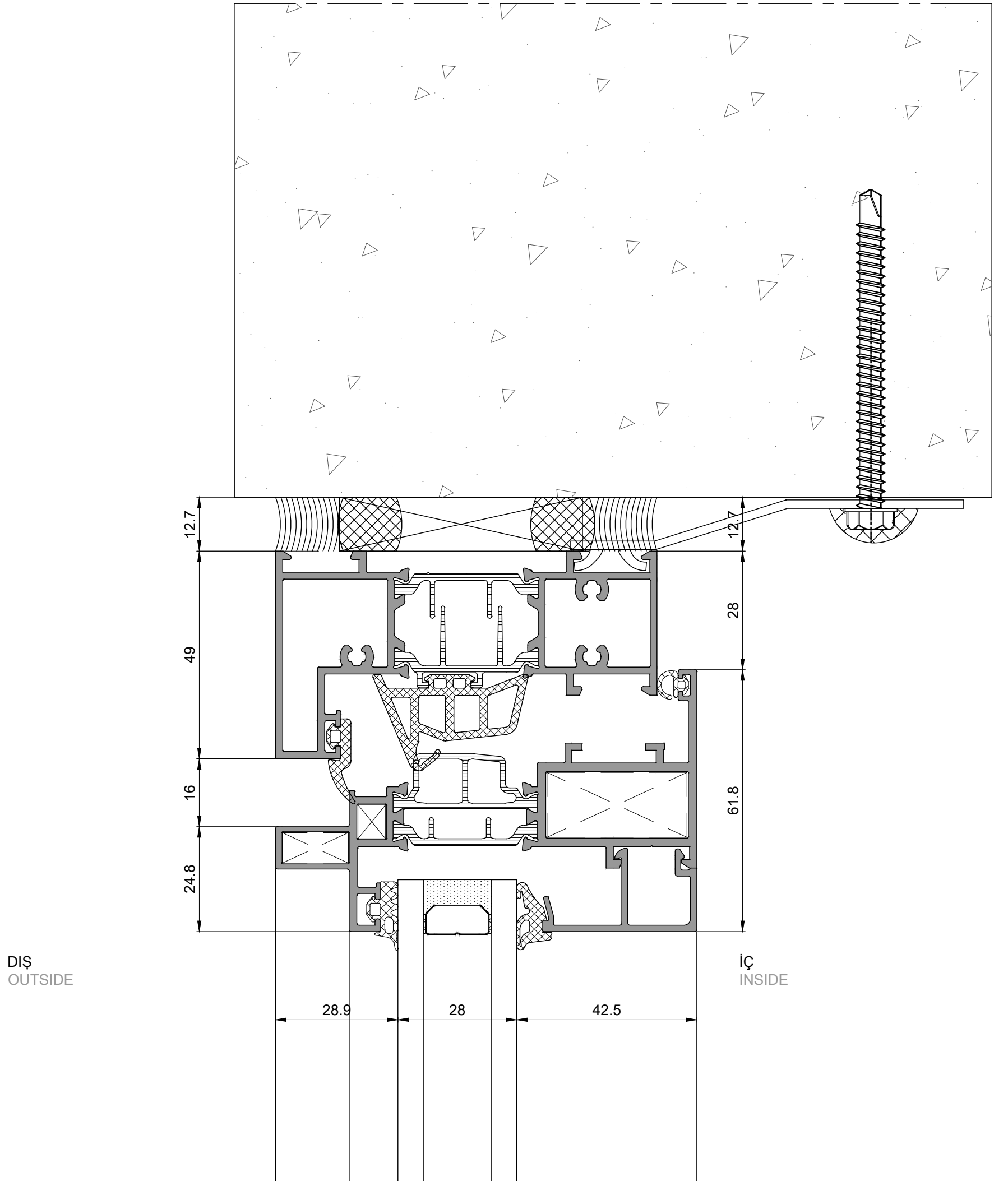
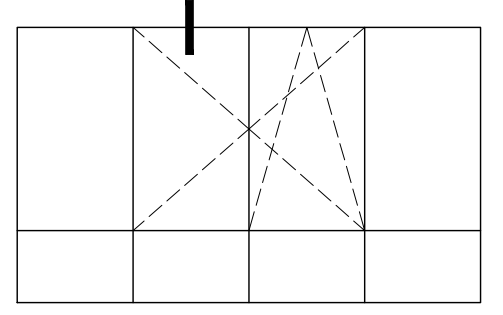

Kapaklı Ters Vasistas Pencere Detayları  
Captured Top Hung Window Sections

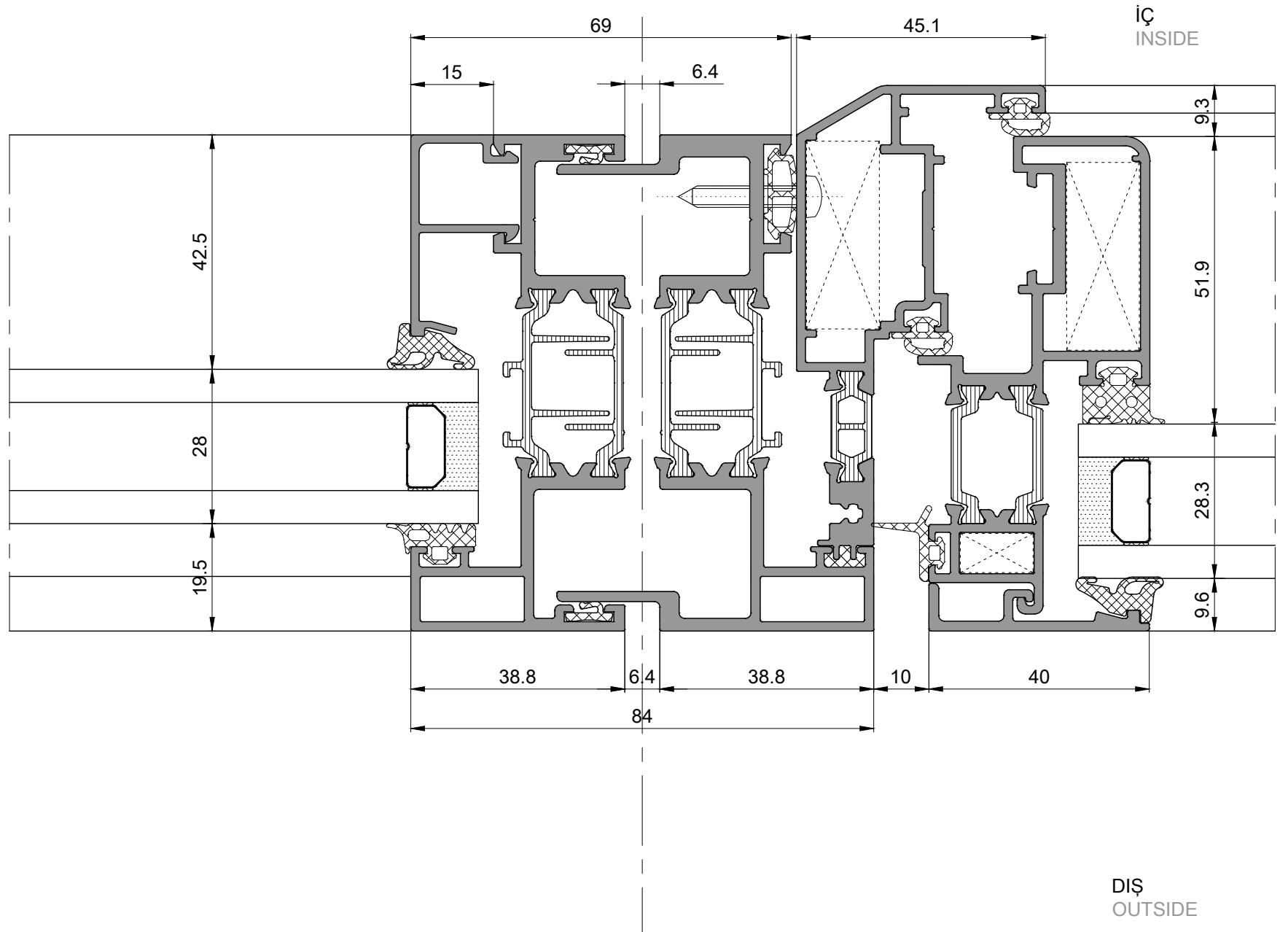
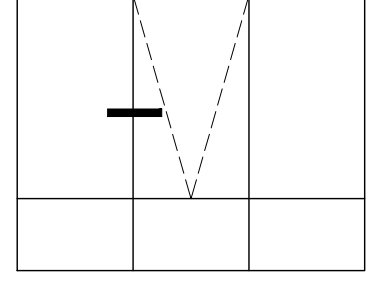

Kapaklı Ters Vasistas Pencere Detayları  
Captured Top Hung Window Sections

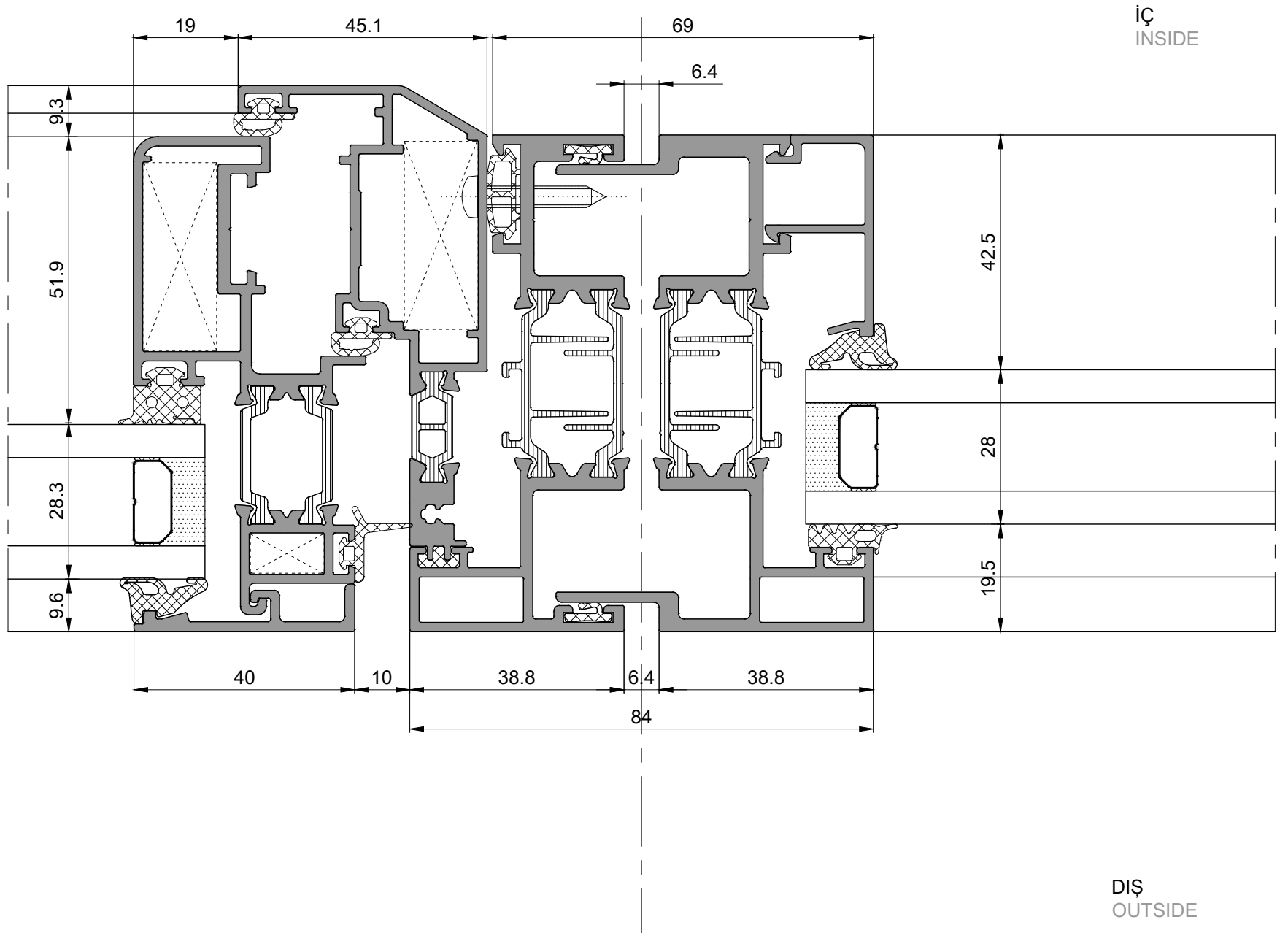
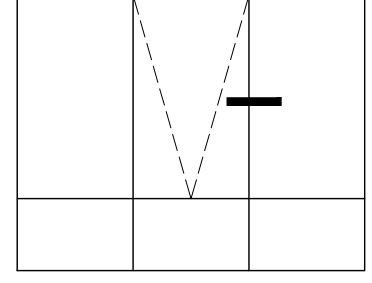



Kapaklı Ters Vasistas Pencere Detayları  
Captured Top Hung Window Sections

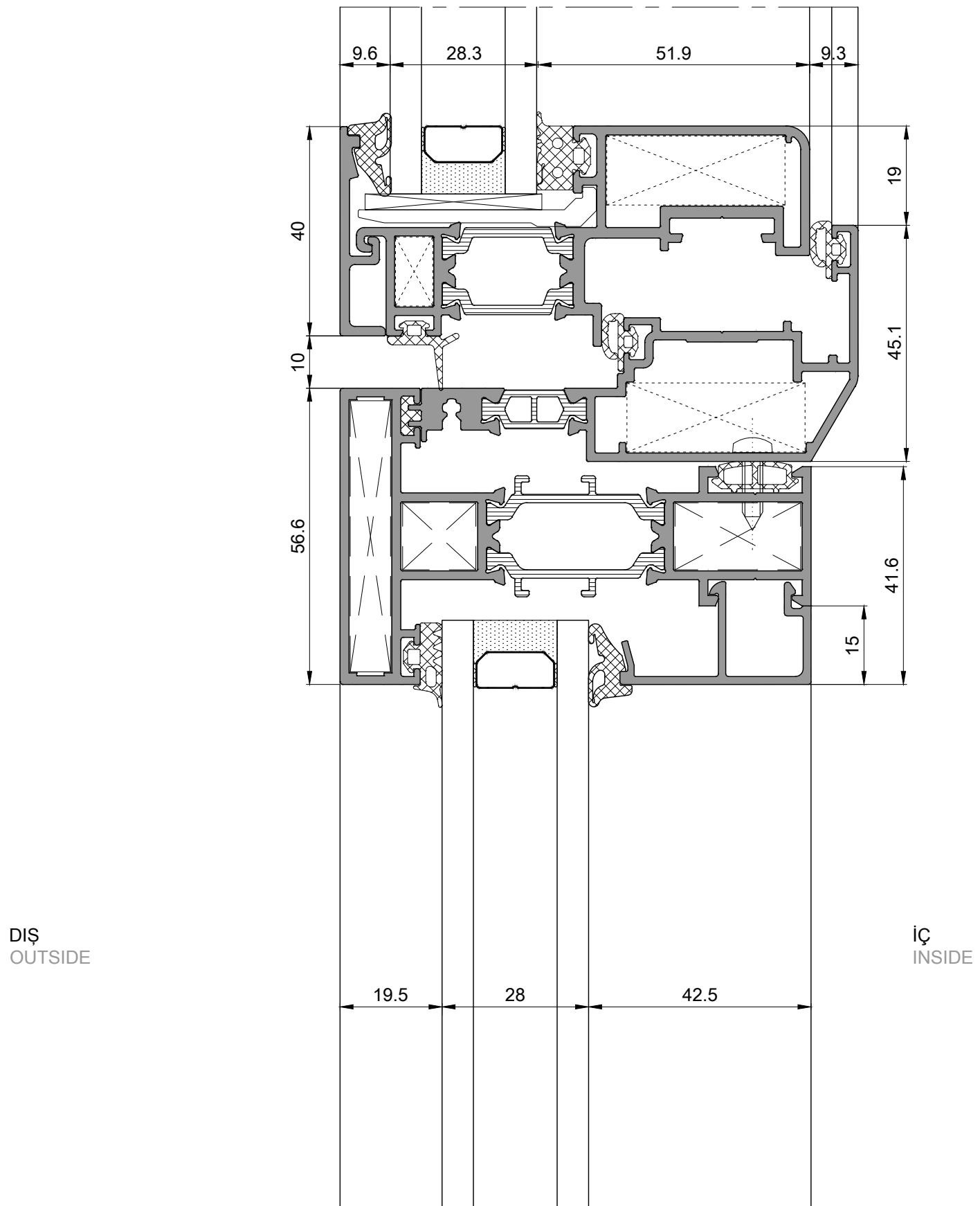
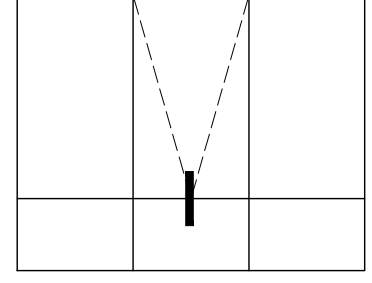

Kapaklı Ters Vasistas Pencere Detayları  
Captured Top Hung Window Sections

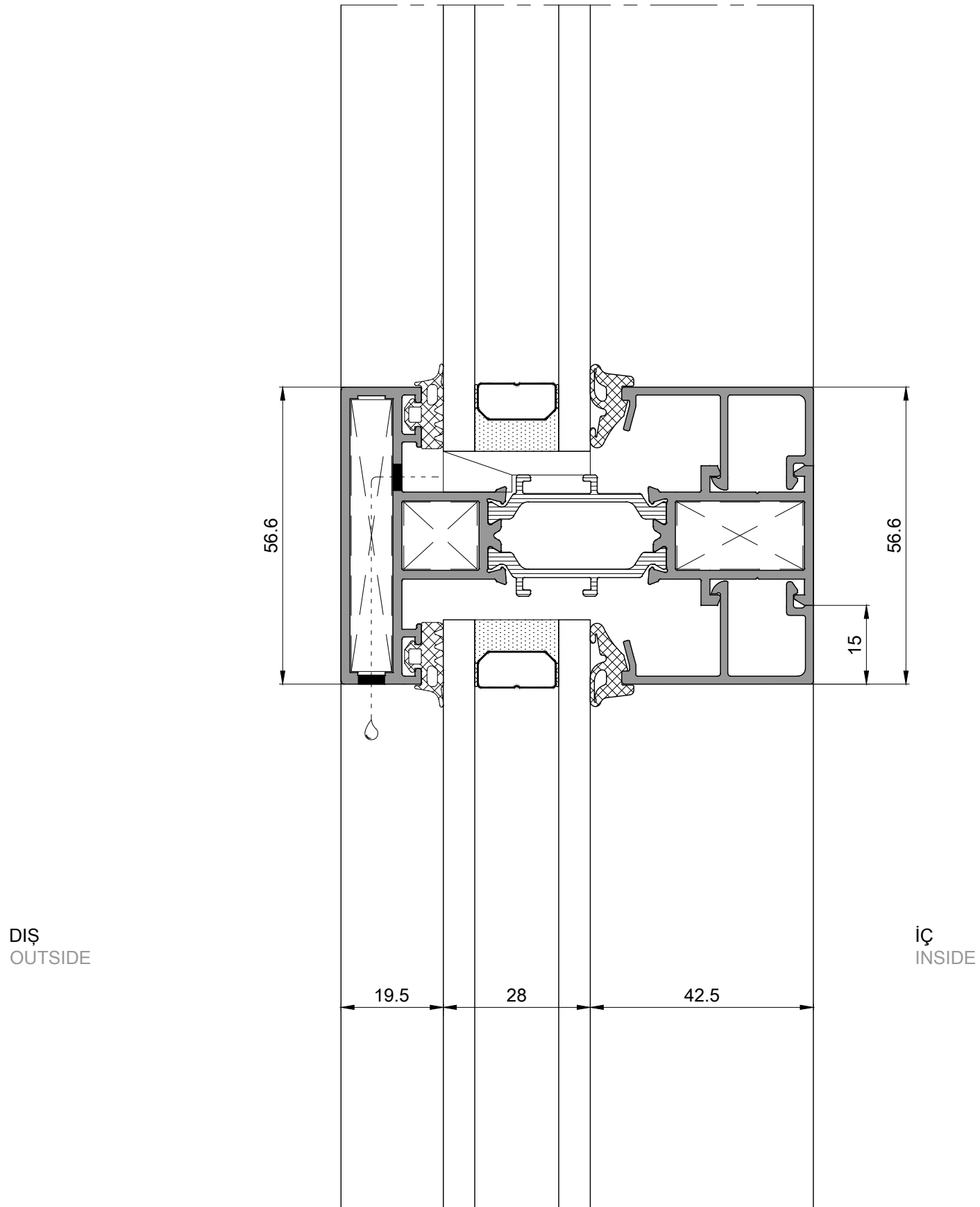
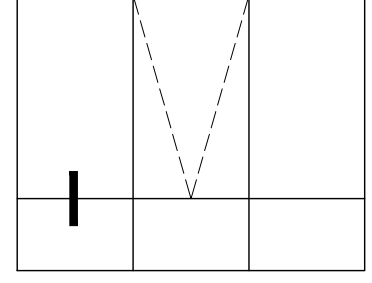

Kapaklı Ters Vasistas Pencere Detayları  
Captured Top Hung Window Sections

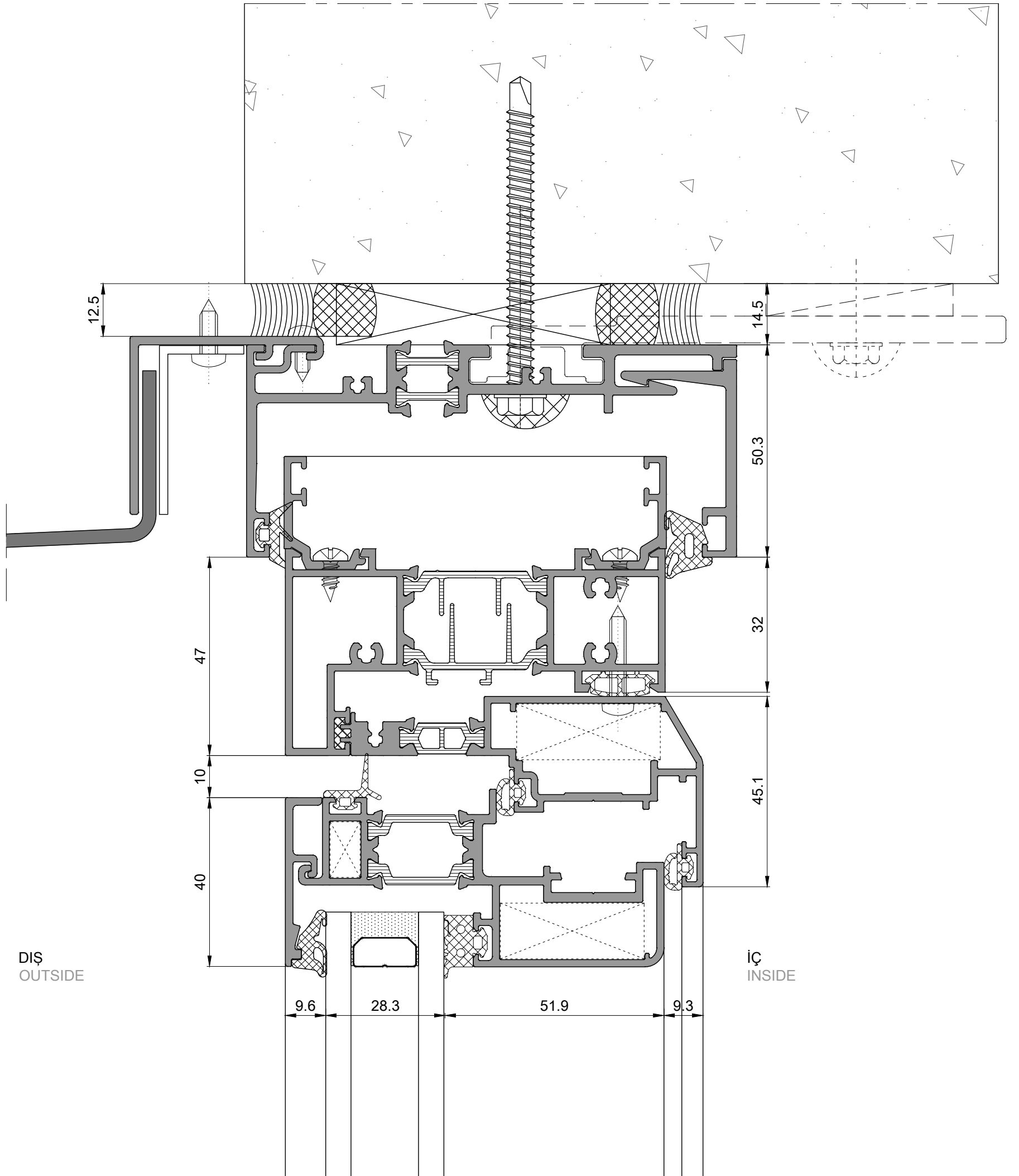
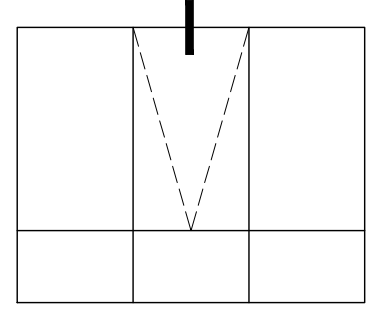

Kapaklı Ters Vasistas Pencere Detayları  
Captured Top Hung Window Sections

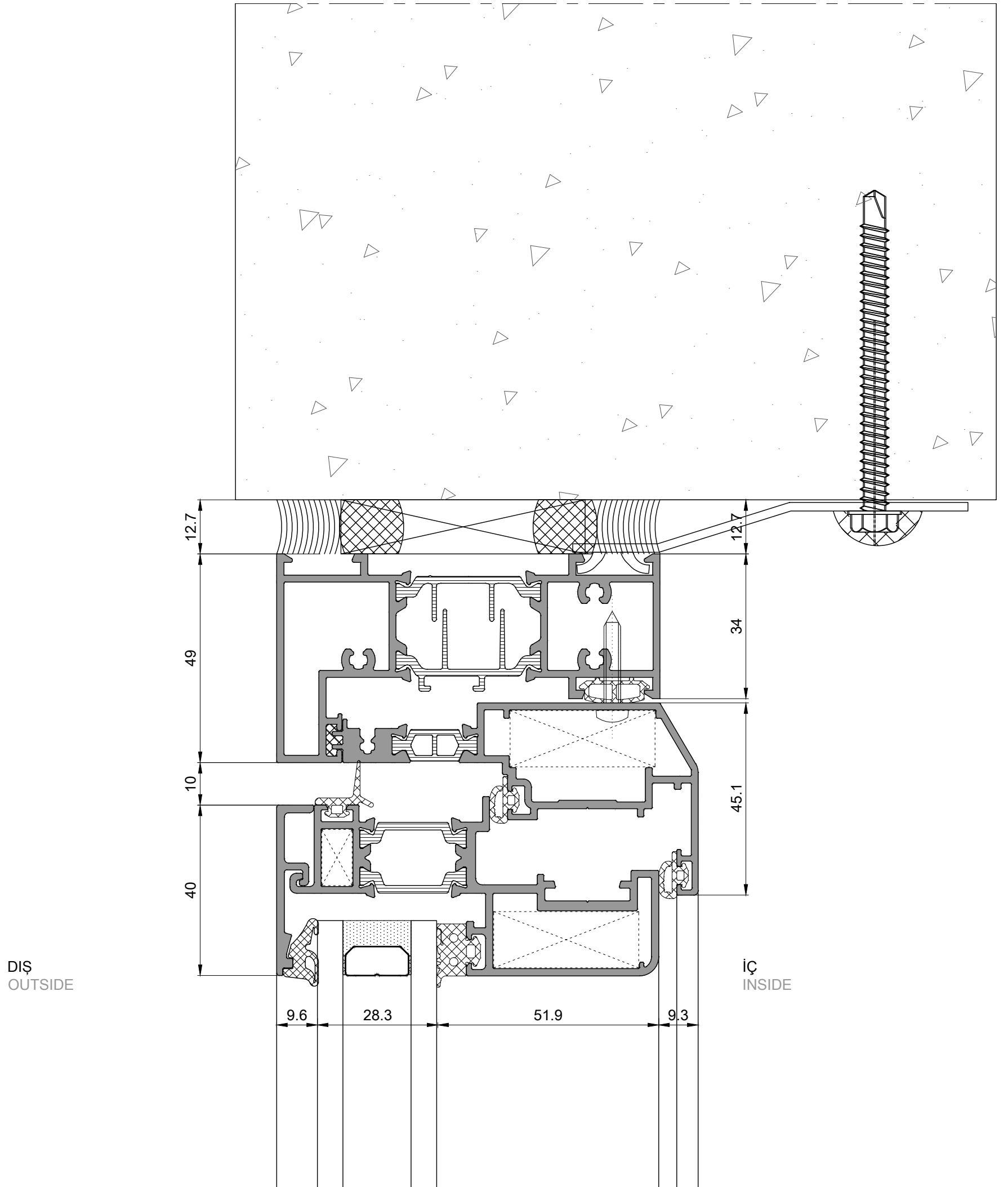
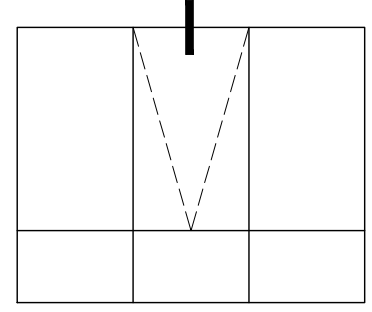

Bondingli Ters Vasistas Pencere Detayları  
Structural Siliconed Top Hung Window Sections

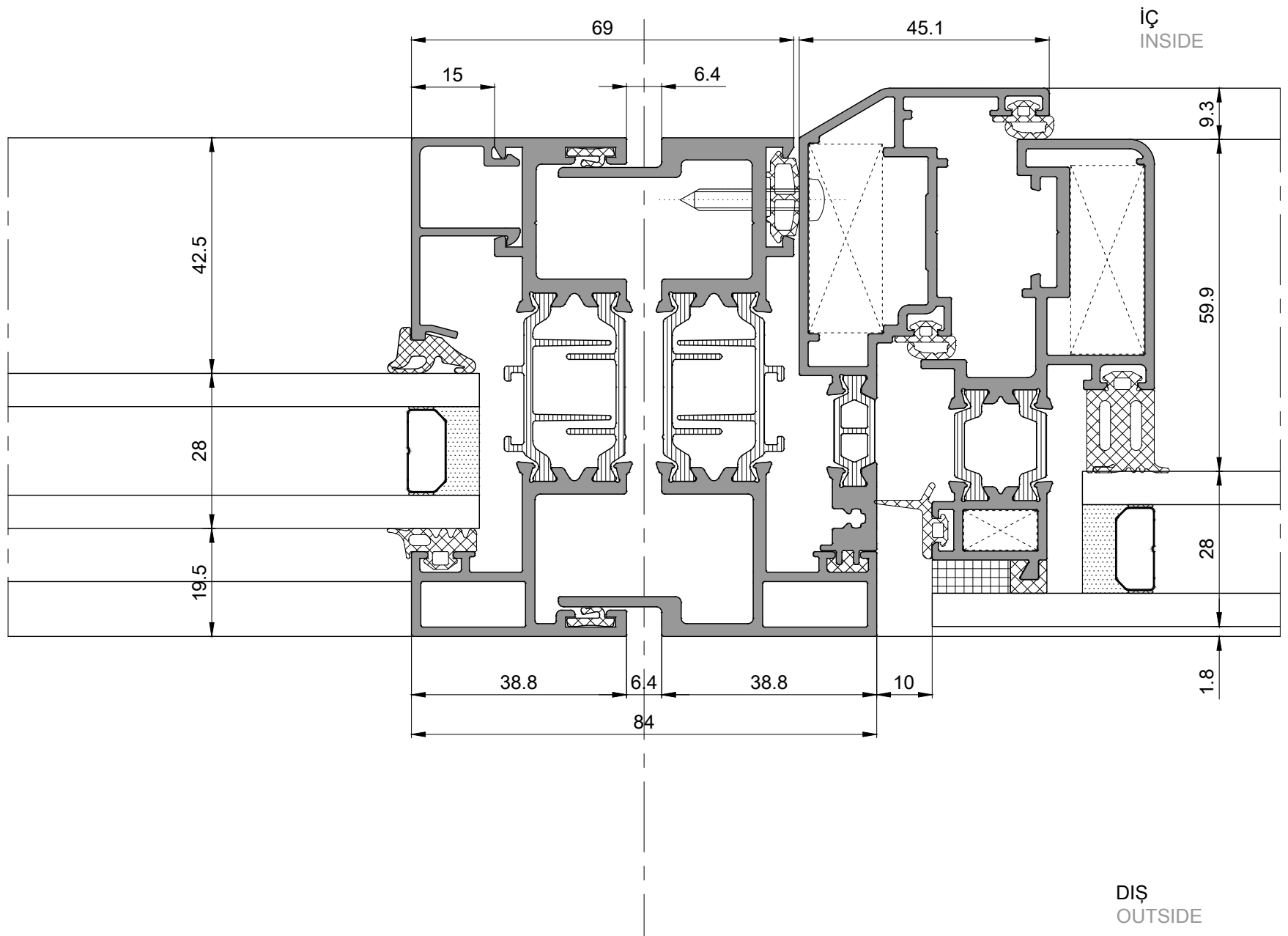
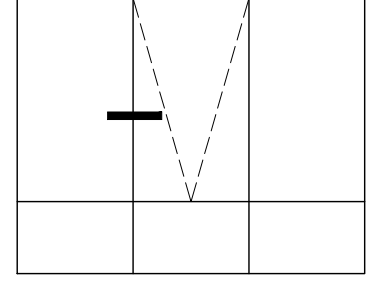

Bondingli Ters Vasistas Pencere Detayları  
Structural Siliconed Top Hung Window Sections

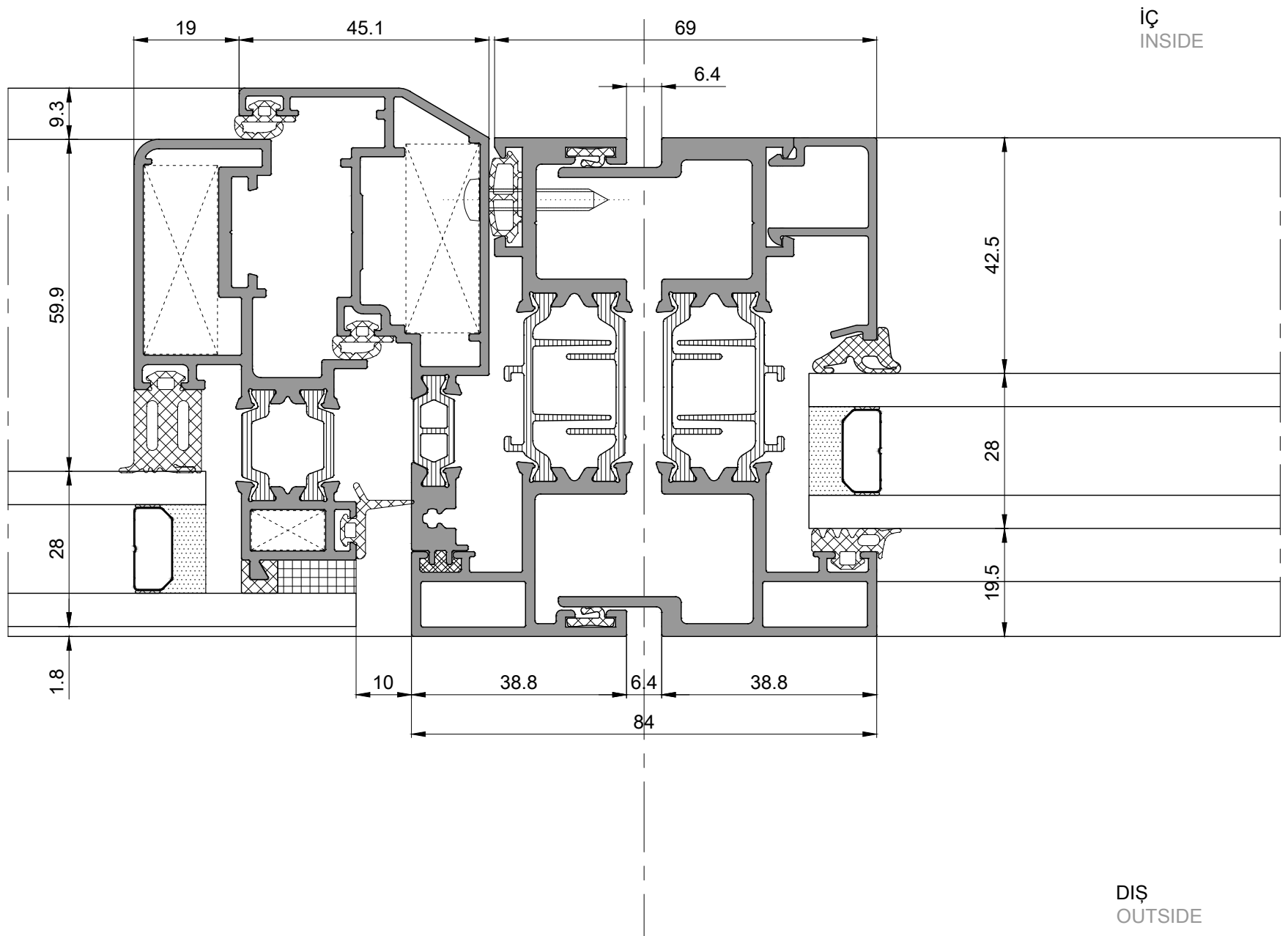
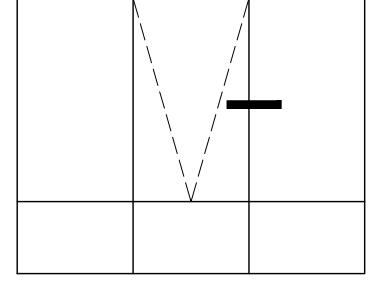

Bondingli Ters Vasistas Pencere Detayları  
Structural Siliconed Top Hung Window Sections

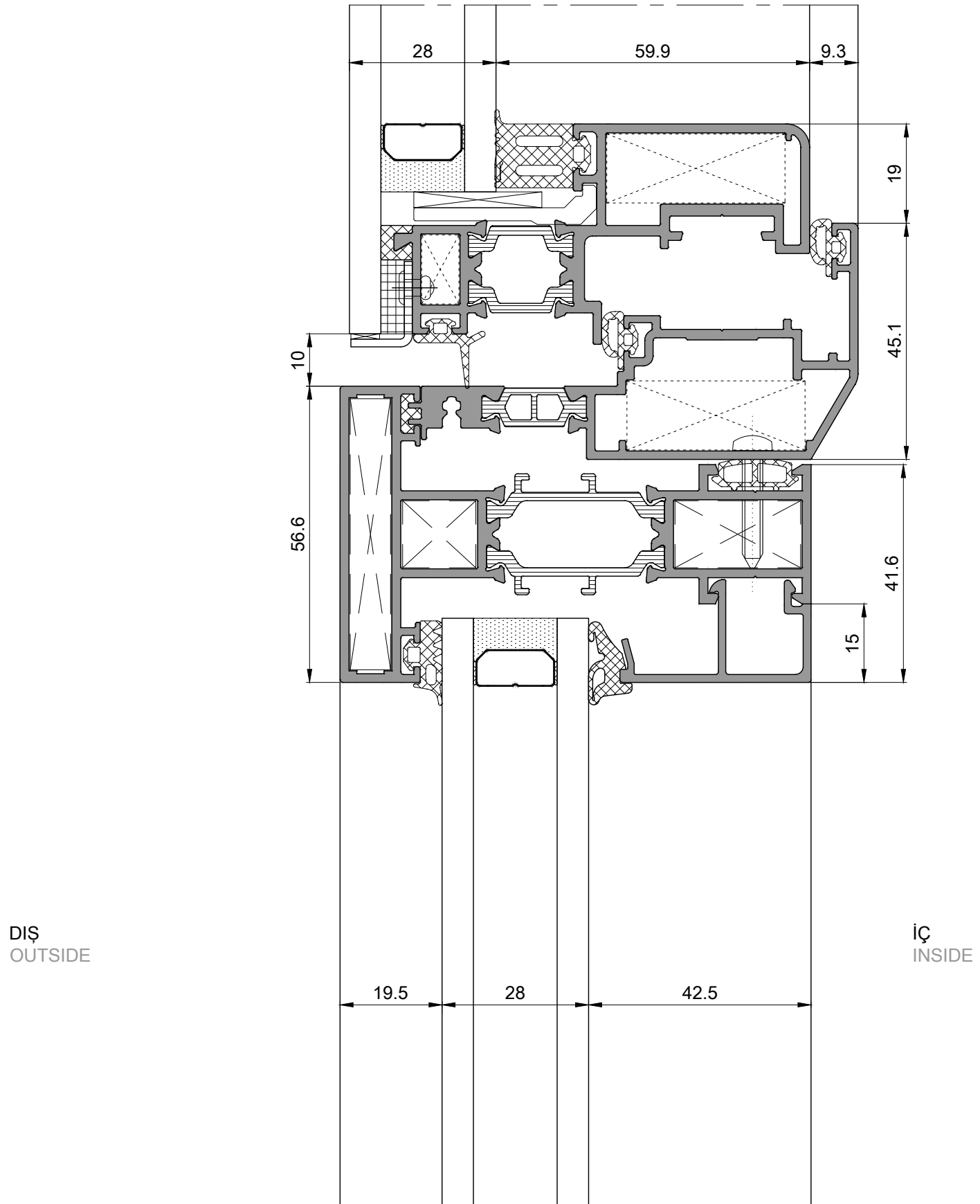
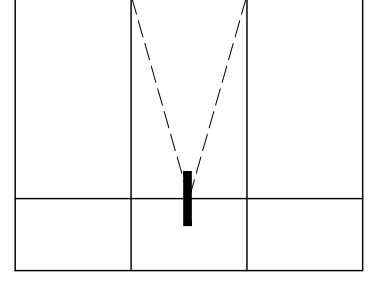

Bondingli Ters Vasistas Pencere Detayları  
Structural Siliconed Top Hung Window Sections

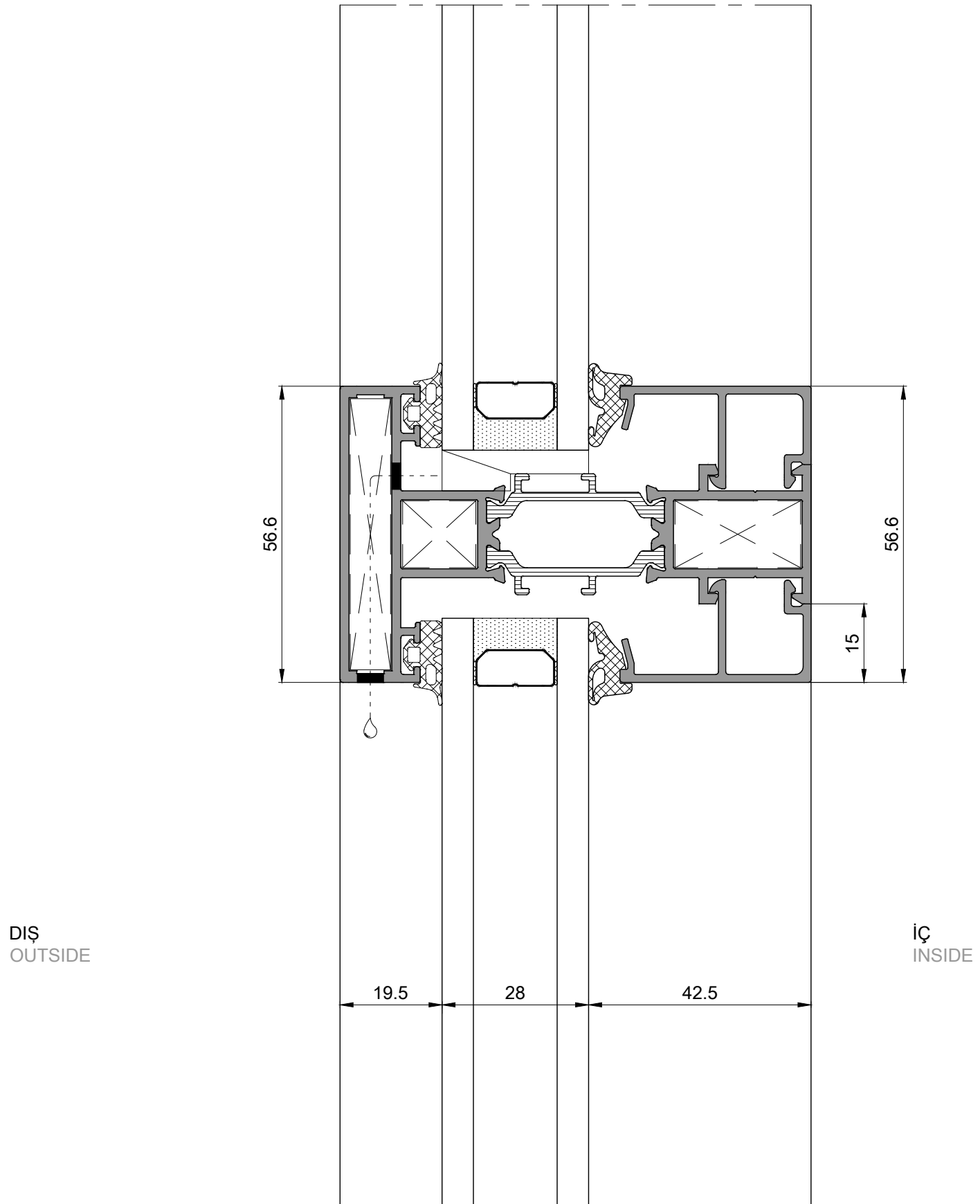
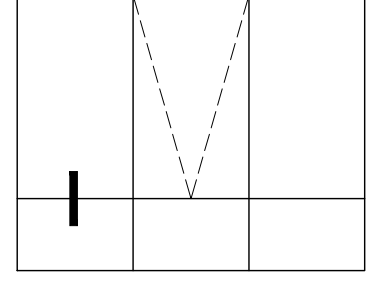



Bondingli Ters Vasistas Pencere Detayları  
Structural Siliconed Top Hung Window Sections

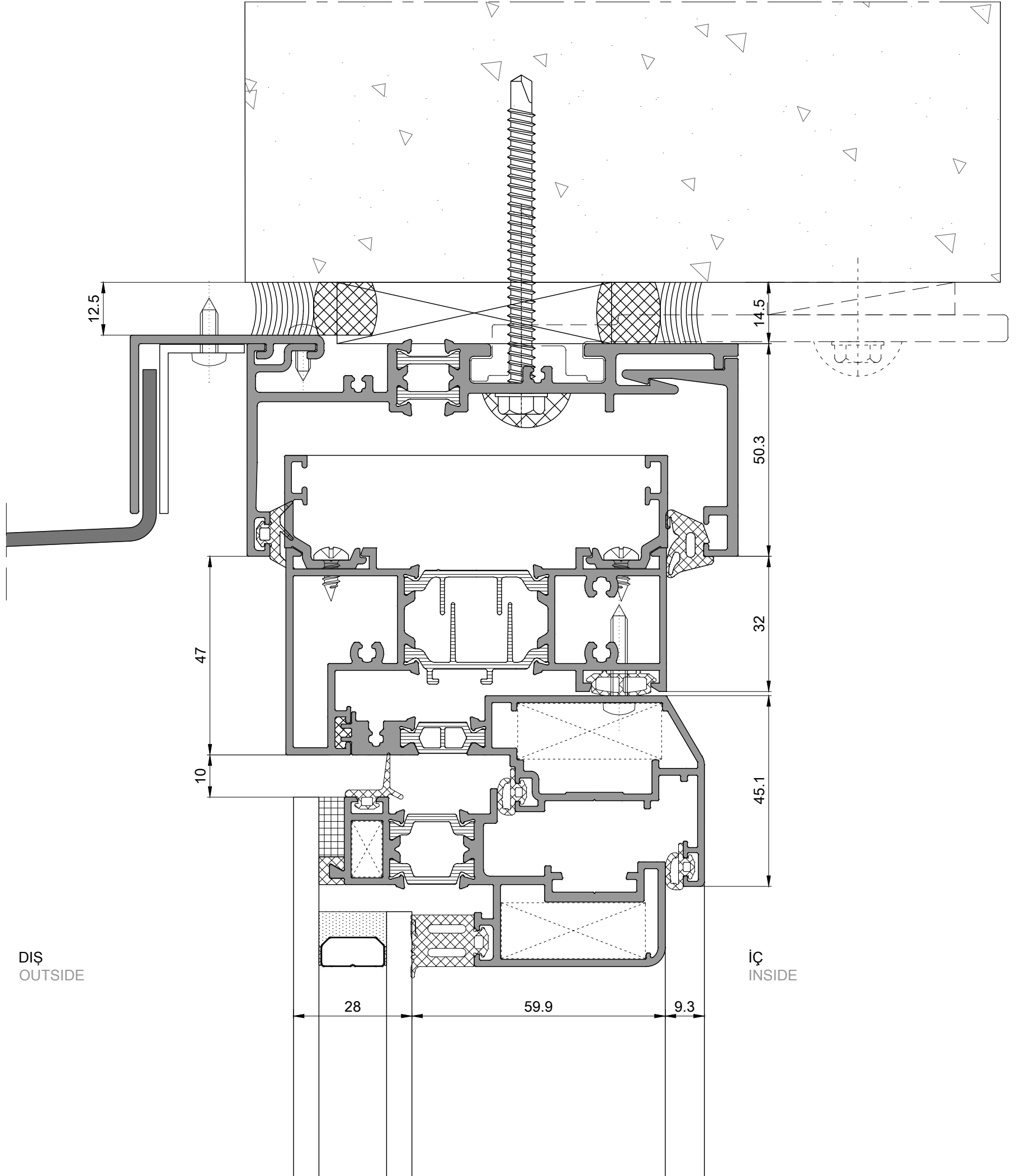
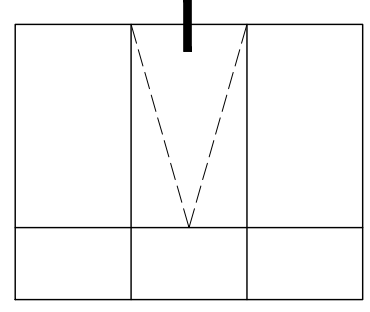

Bondingli Ters Vasistas Pencere Detayları  
Structural Siliconed Top Hung Window Sections

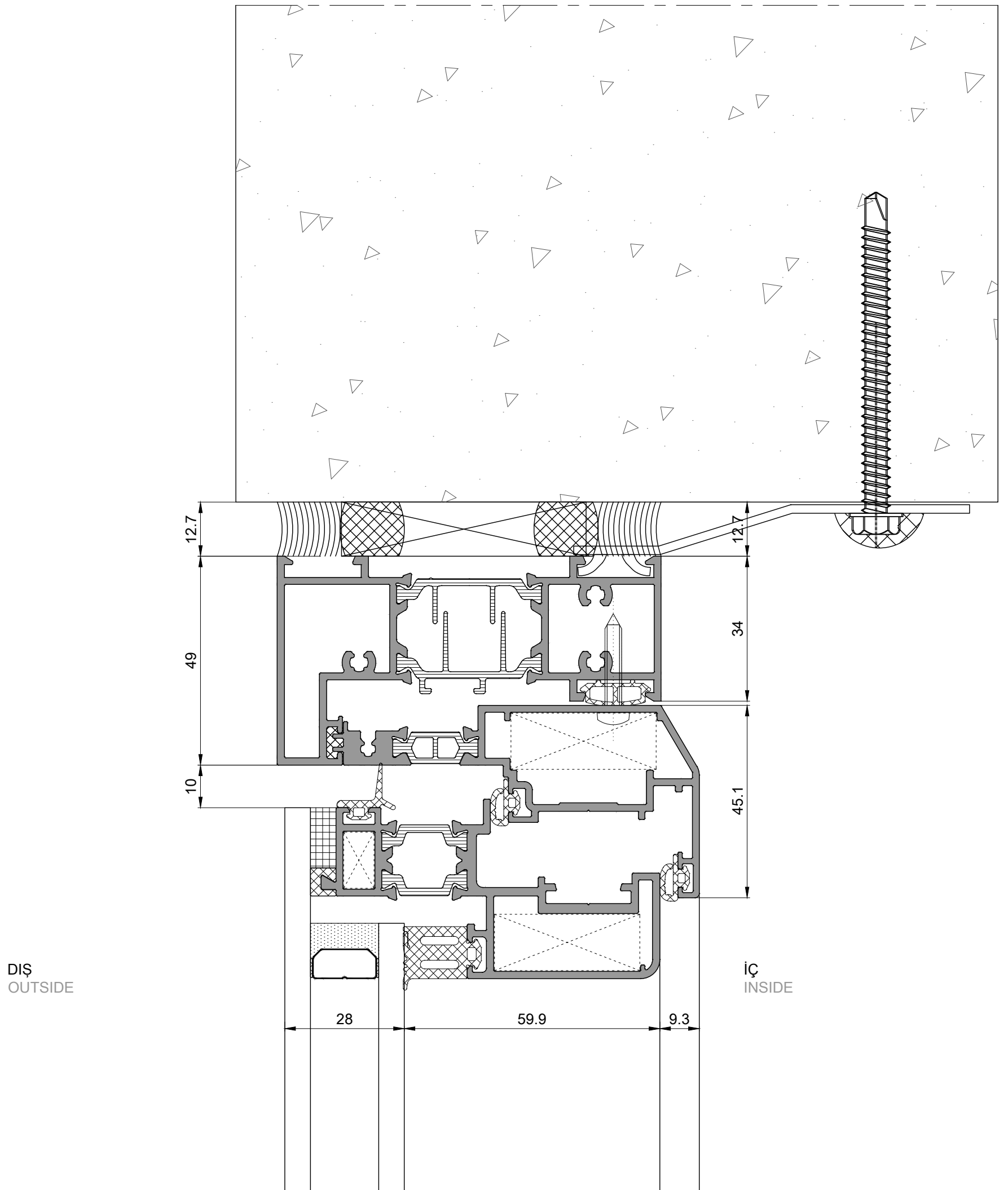
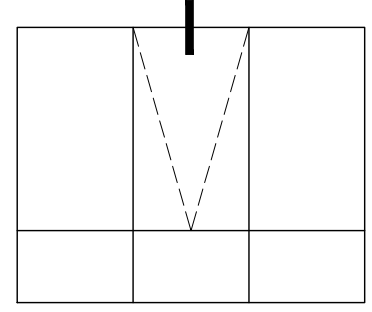

İçe Açılır Binili Kapı Detayları  
Inward Opening Rebate Door Sections

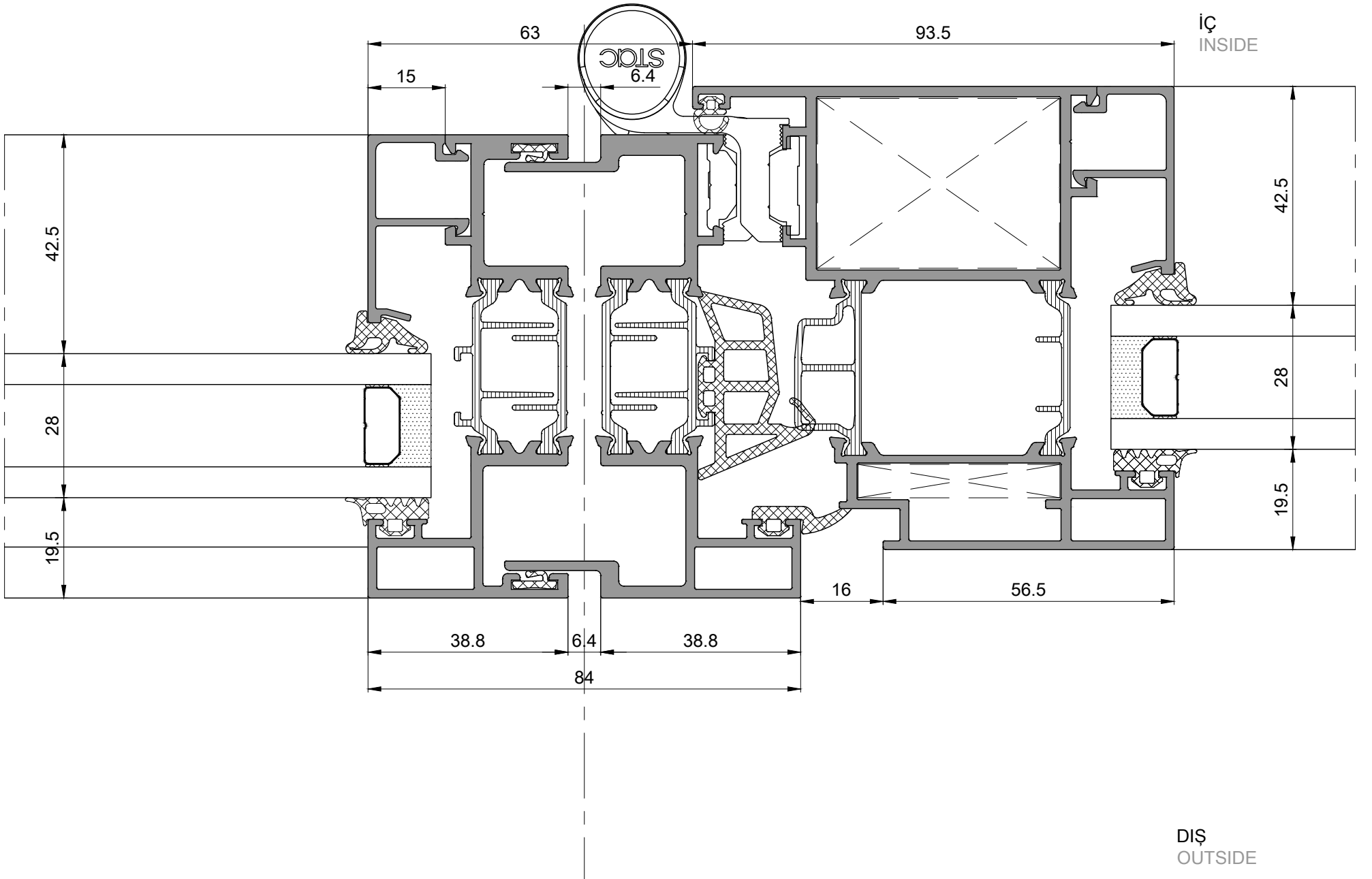
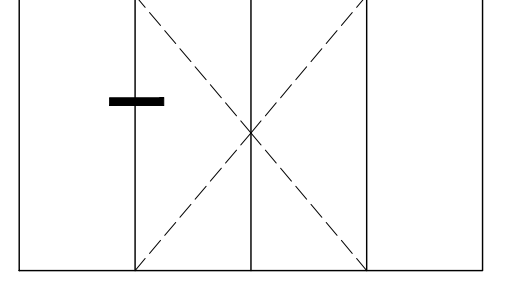

İçe Açılır Binili Kapı Detayları  
Inward Opening Rebate Door Sections

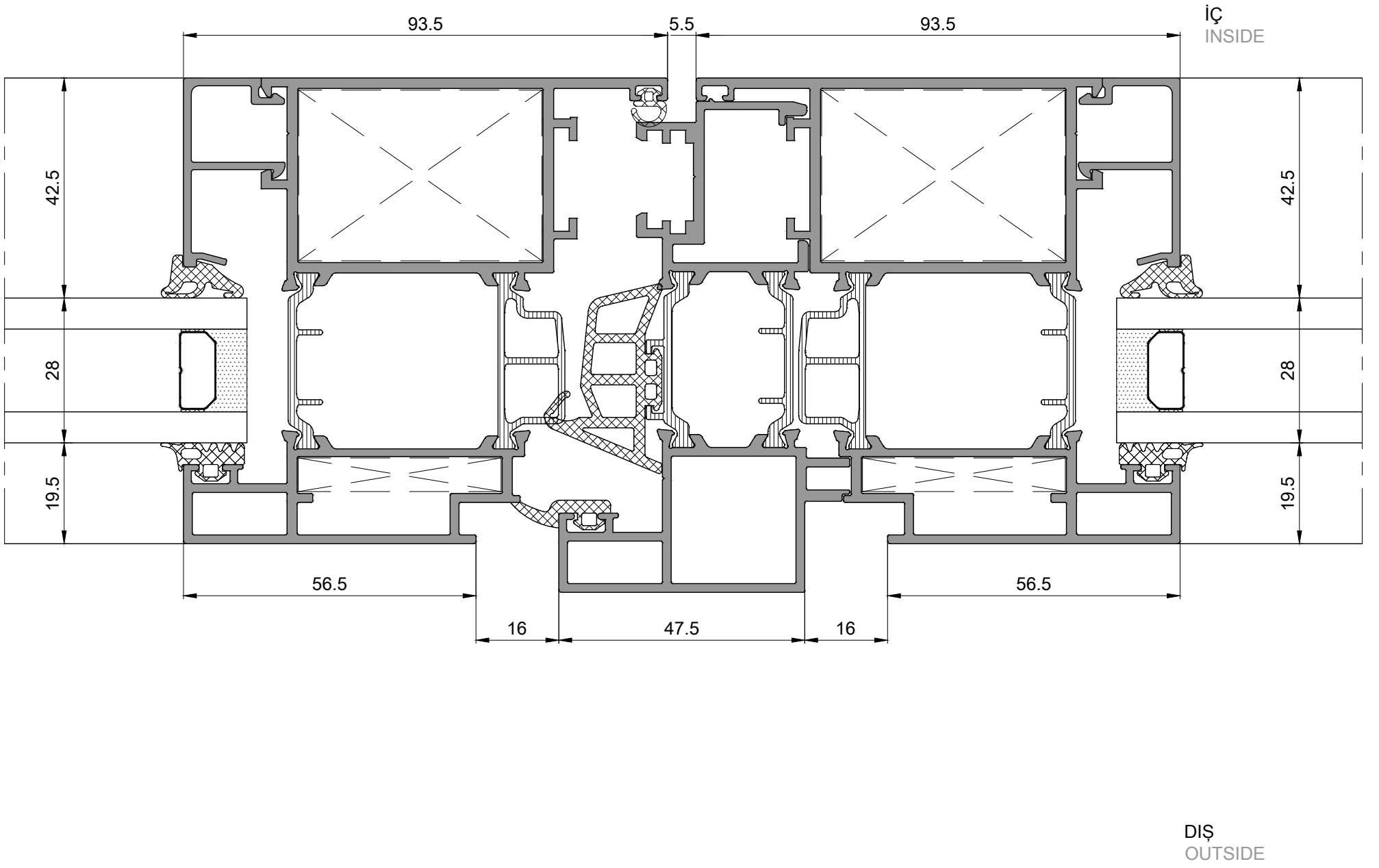
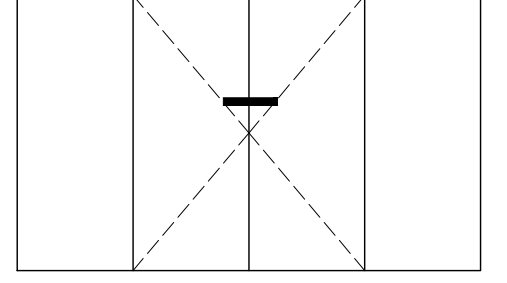

**İçe Açılır Binili Kapı Detayları**  
Inward Opening Rebate Door Sections

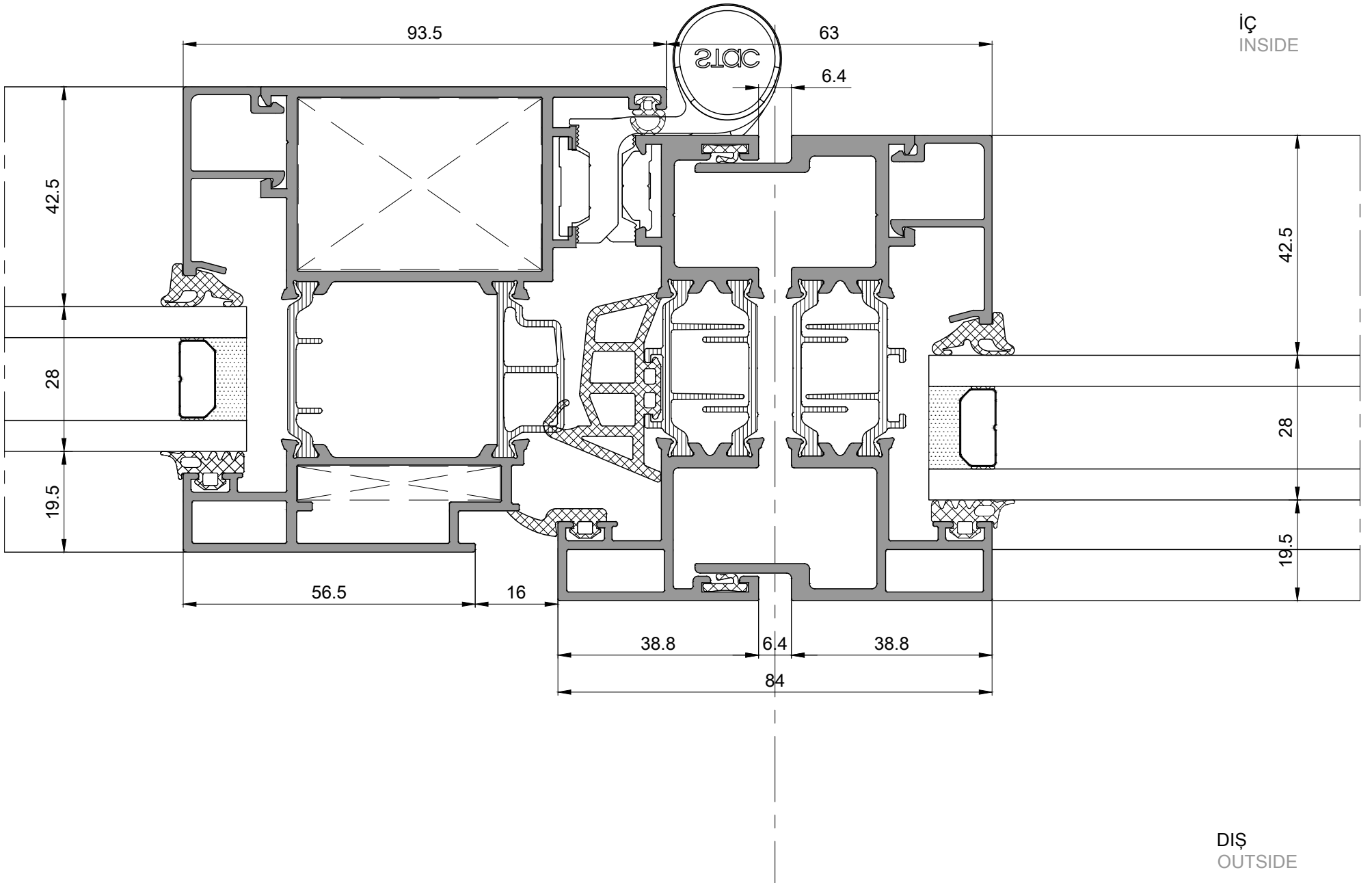
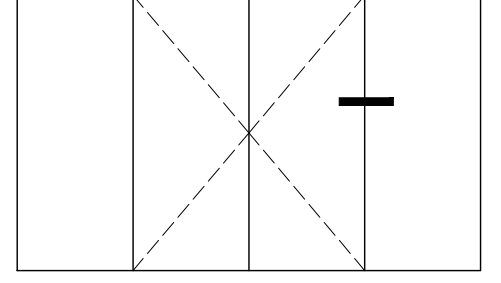

İçe Açılır Binili Kapı Detayları  
Inward Opening Rebate Door Sections

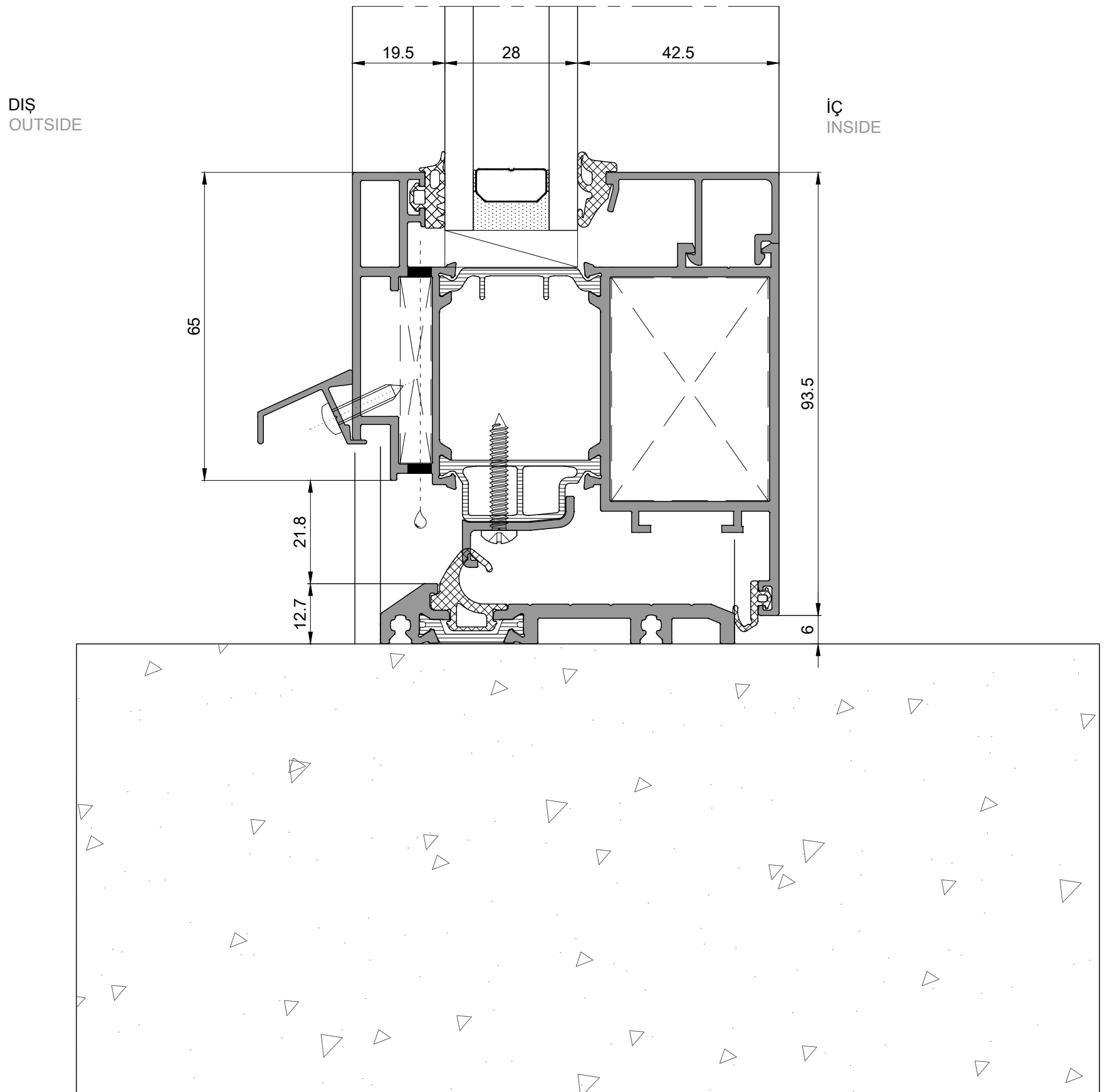
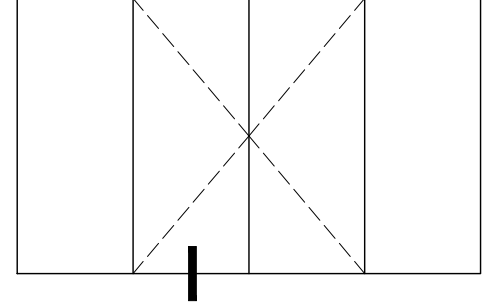

İçe Açılır Binili Kapı Detayları  
Inward Opening Rebate Door Sections

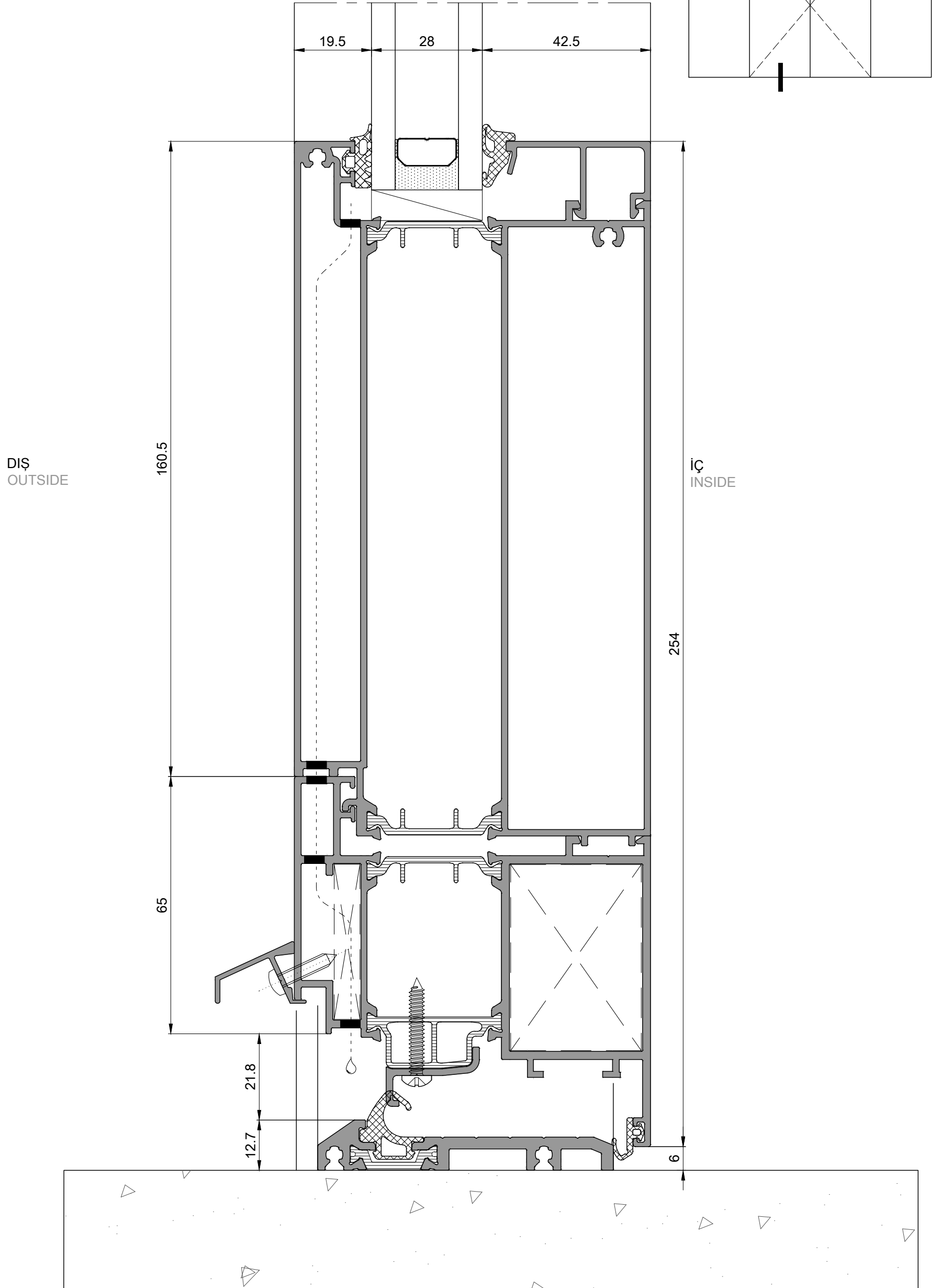

**İçe Açılır Binili Kapı Detayları**  
Inward Opening Rebate Door Sections

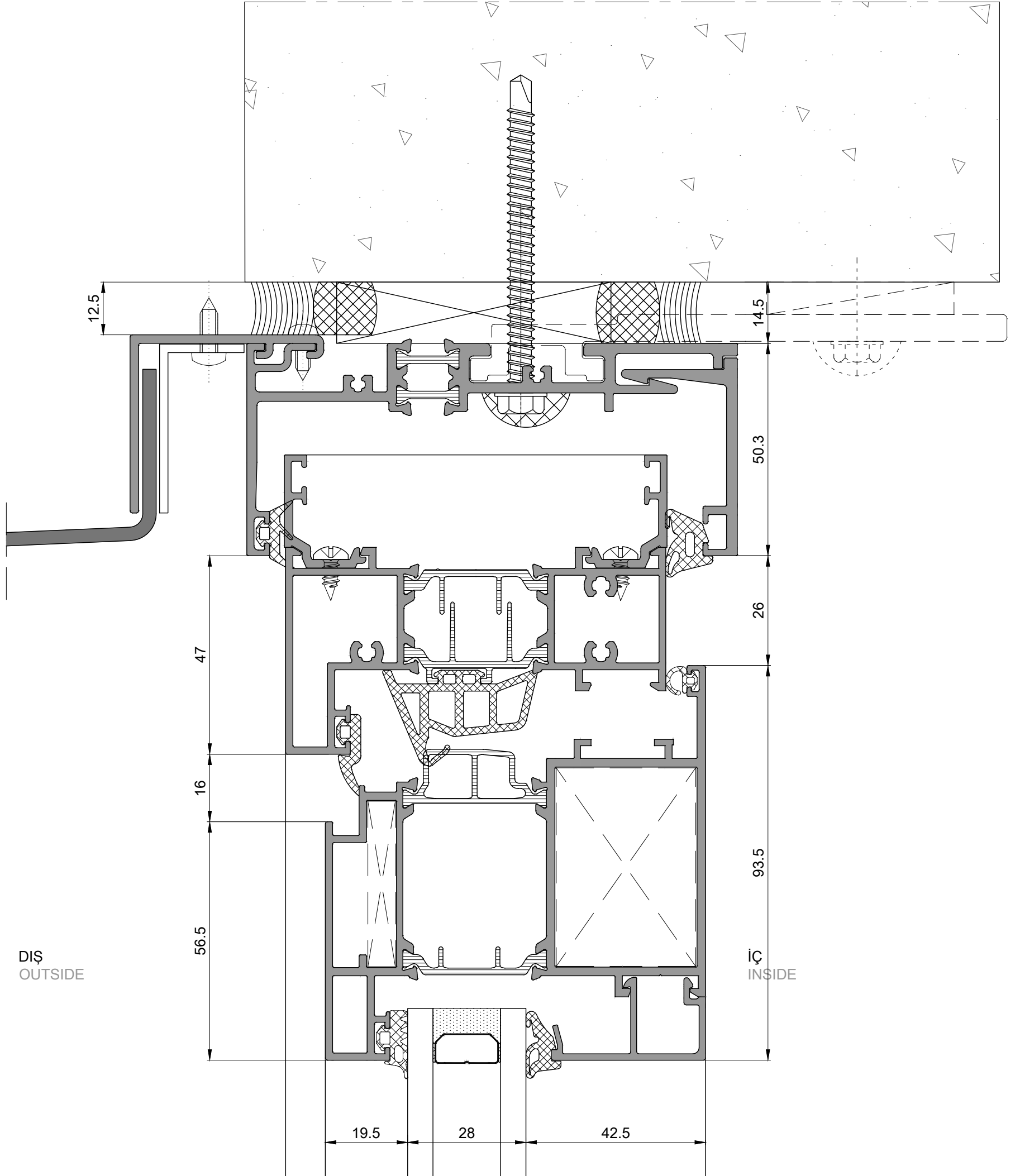
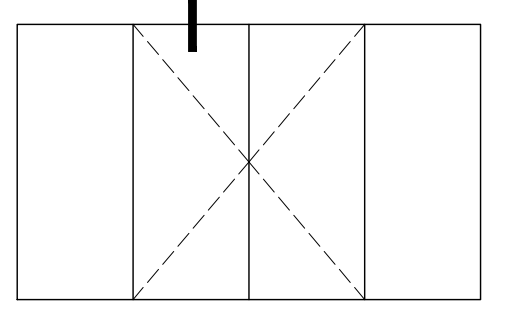



İçe Açılır Binili Kapı Detayları  
Inward Opening Rebate Door Sections

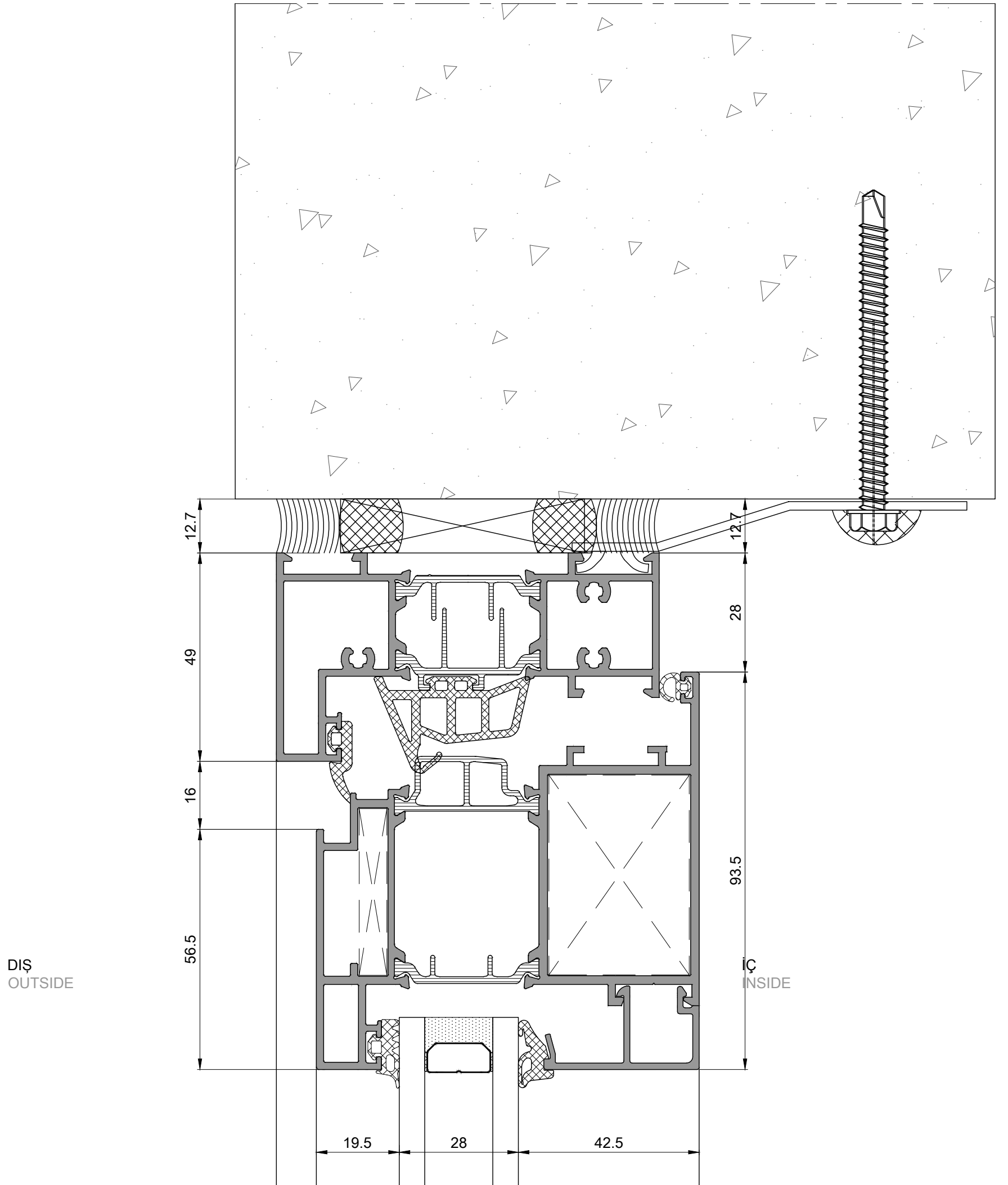
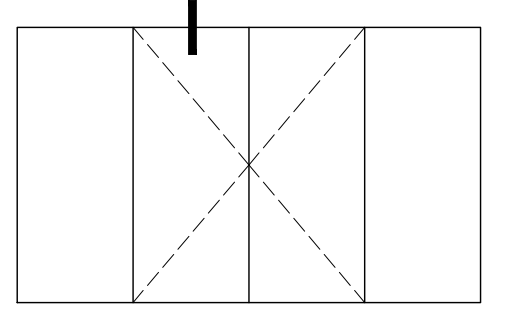



Dışa Açılır Binili Kapı Detayları  
Outward Opening Rebate Door Sections

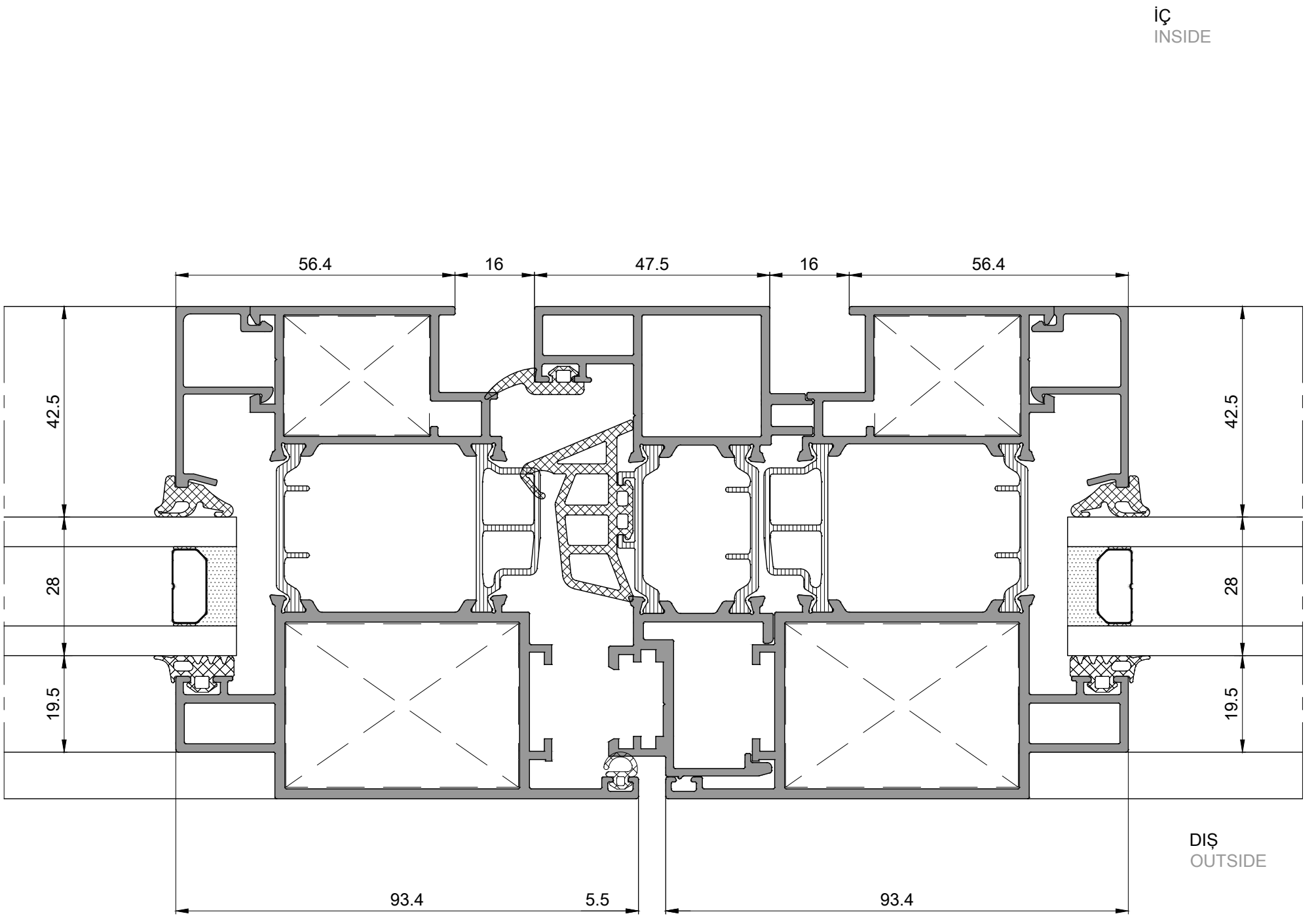
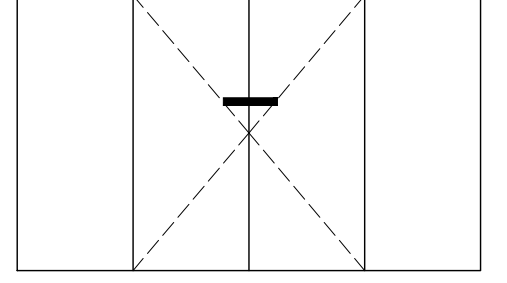

Dışa Açılır Binili Kapı Detayları  
Outward Opening Rebate Door Sections

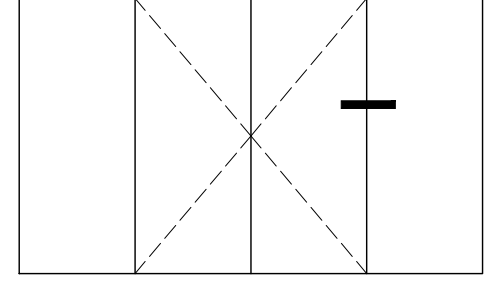

İÇ  
INSIDE

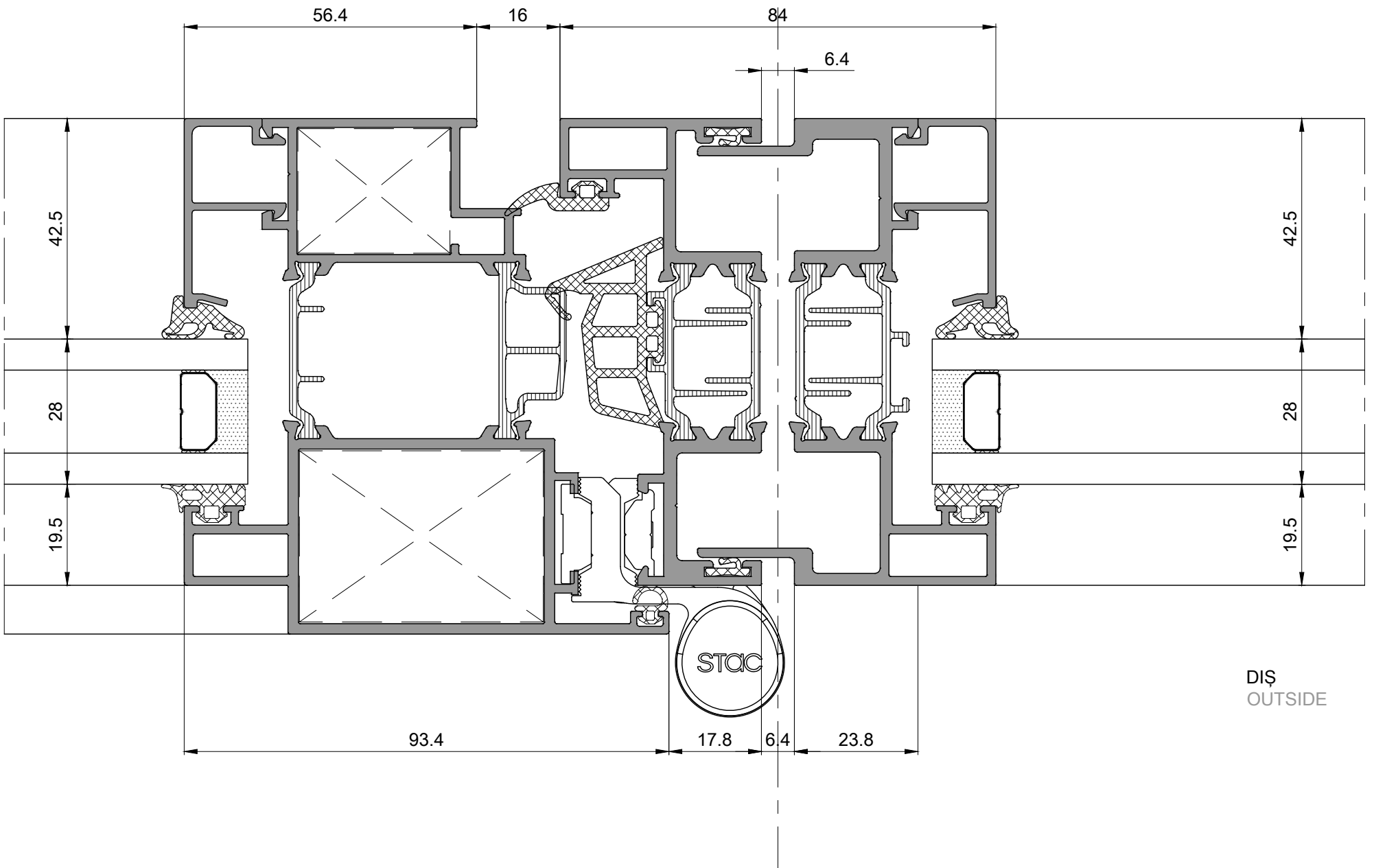

Dışa Açılır Binili Kapı Detayları  
Outward Opening Rebate Door Sections

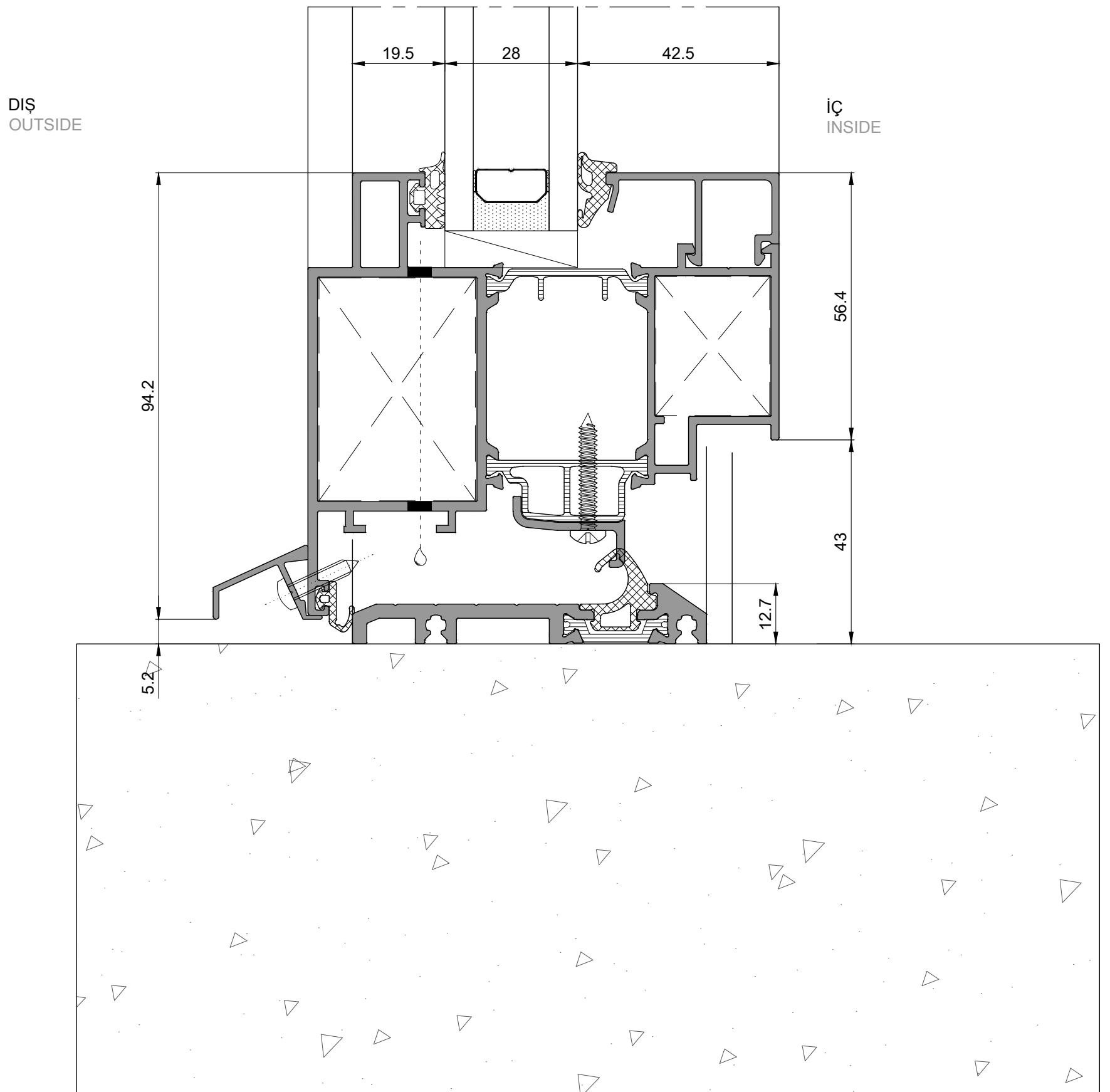
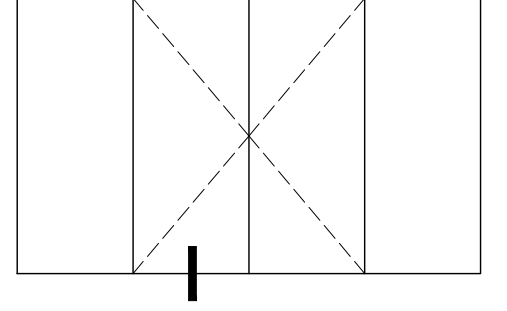

Dışa Açılır Binili Kapı Detayları  
Outward Opening Rebate Door Sections

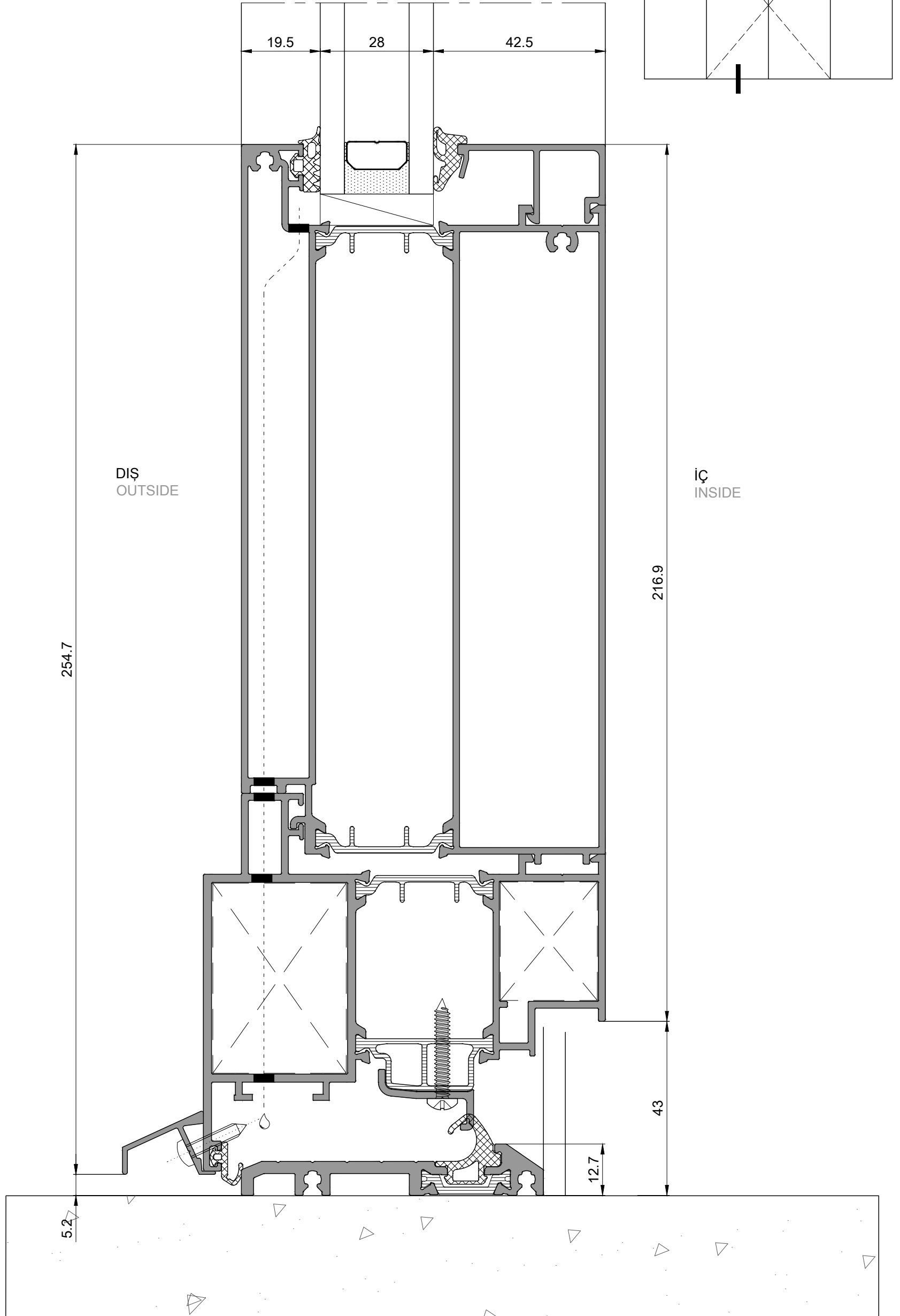

Dışa Açılır Binili Kapı Detayları  
Outward Opening Rebate Door Sections

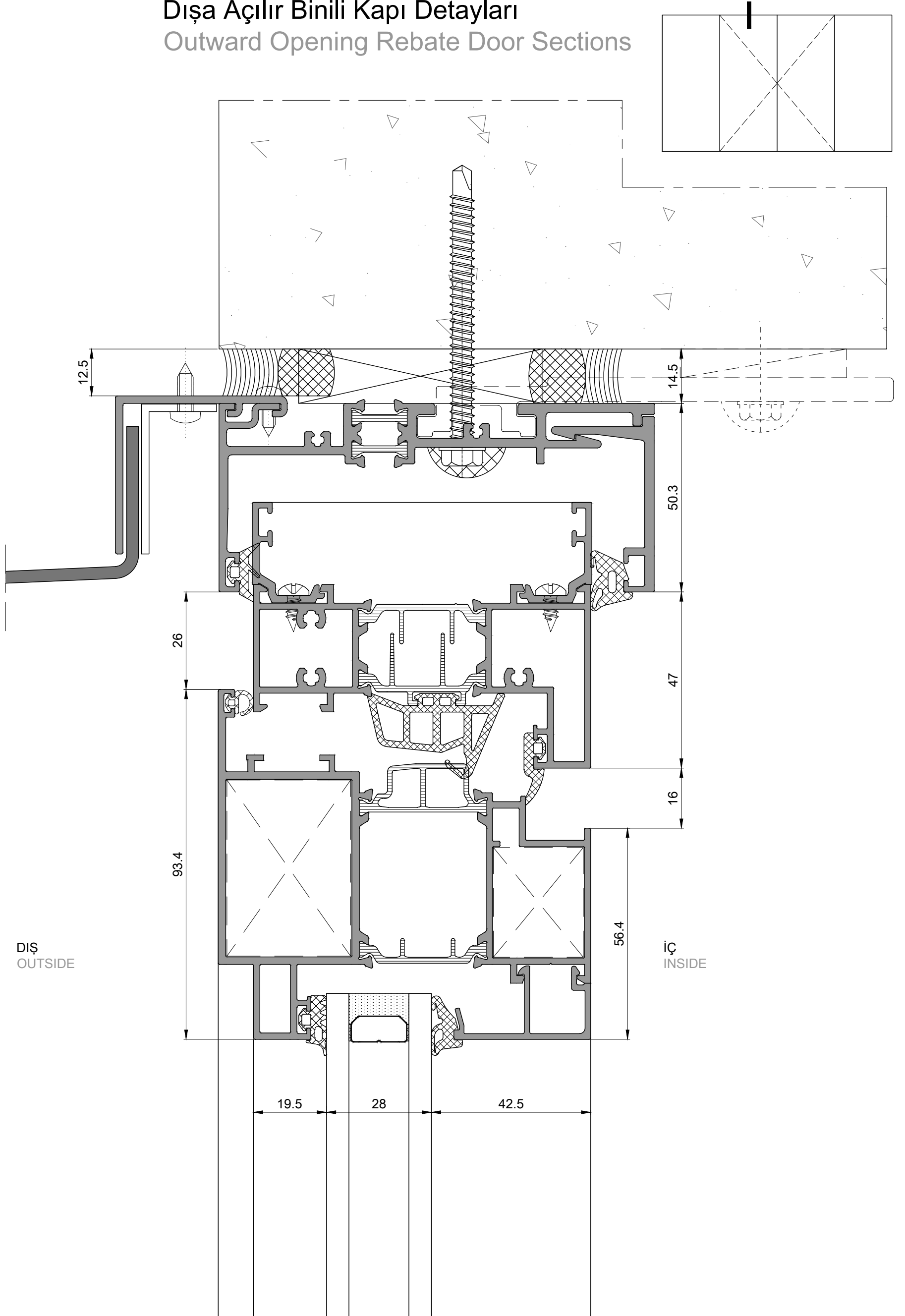

Dışa Açılır Binili Kapı Detayları  
Outward Opening Rebate Door Sections

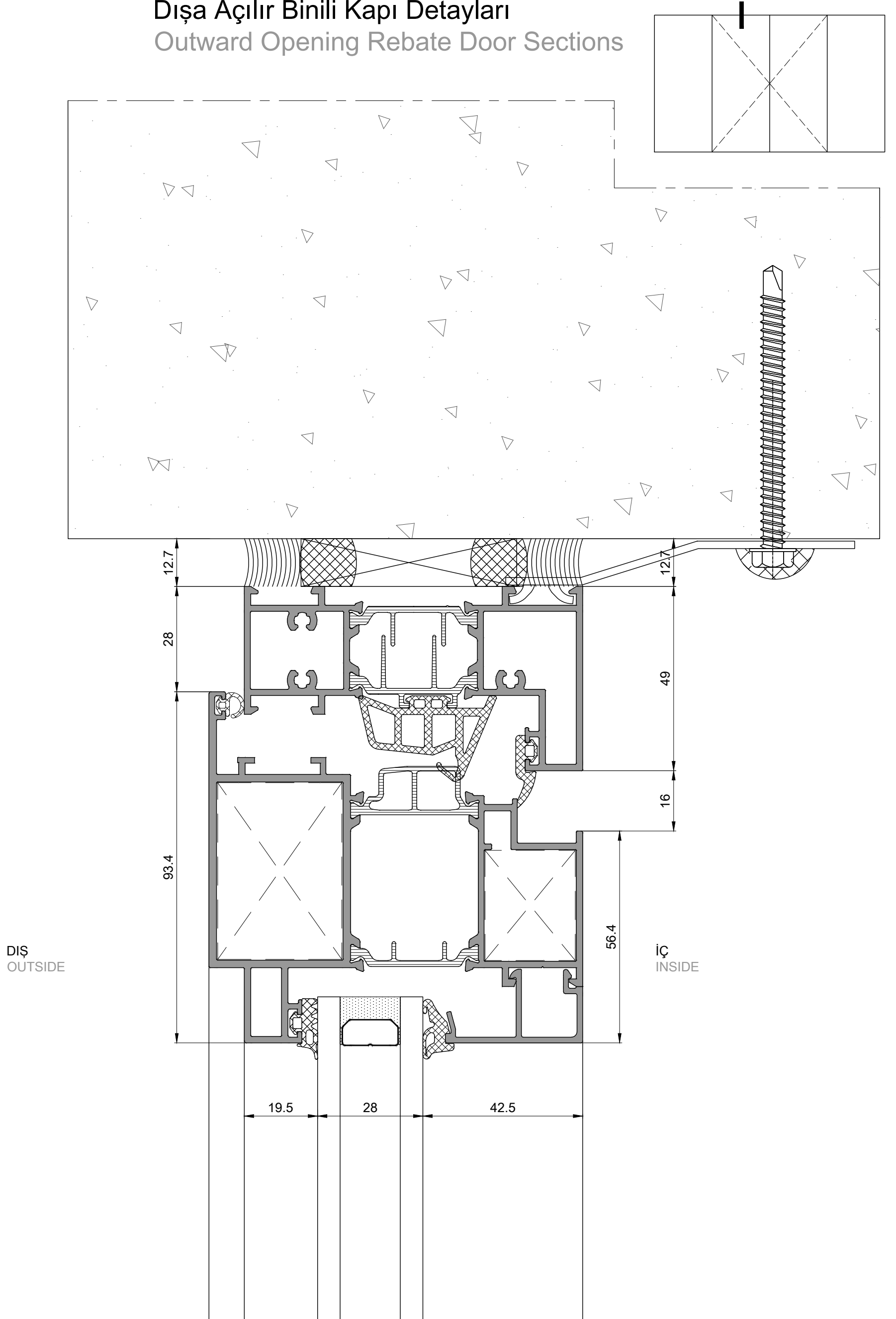





Dışa Açılır Hemyüz Kapı Detayları  
Outward Opening Flush Door Sections

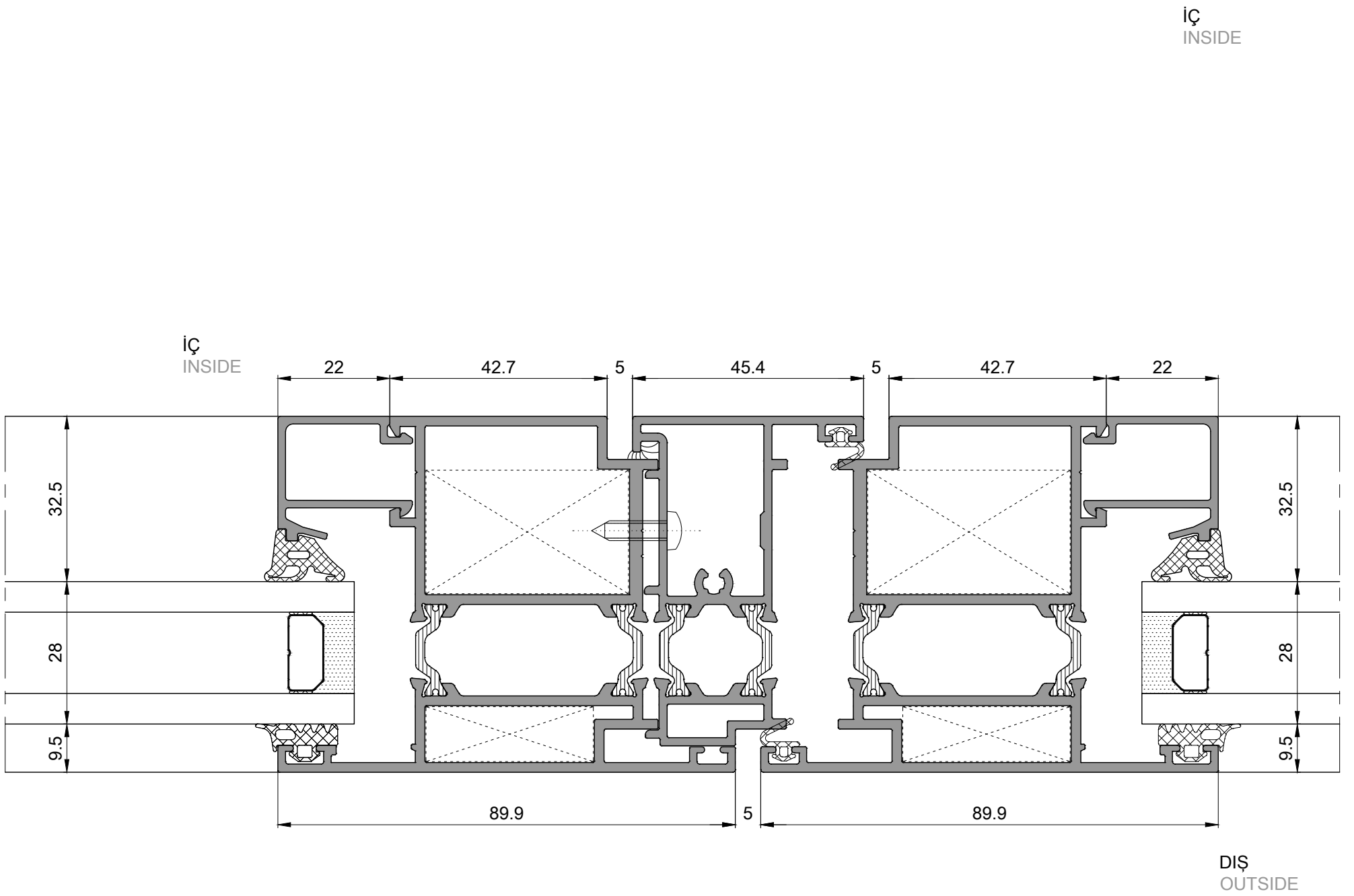
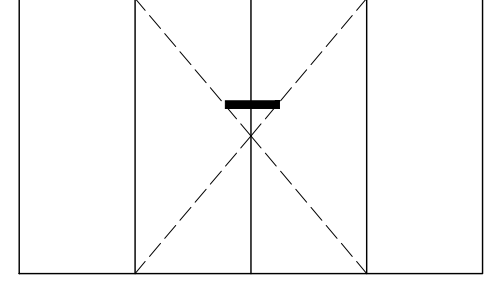

Dışa Açılır Hemyüz Kapı Detayları  
Outward Opening Flush Door Sections

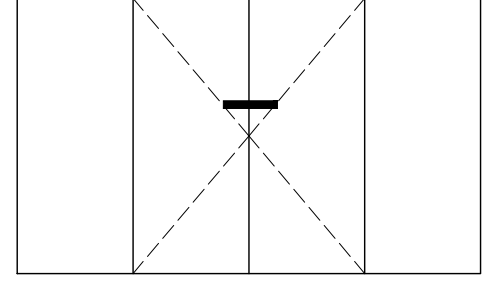

İÇ  
INSIDE

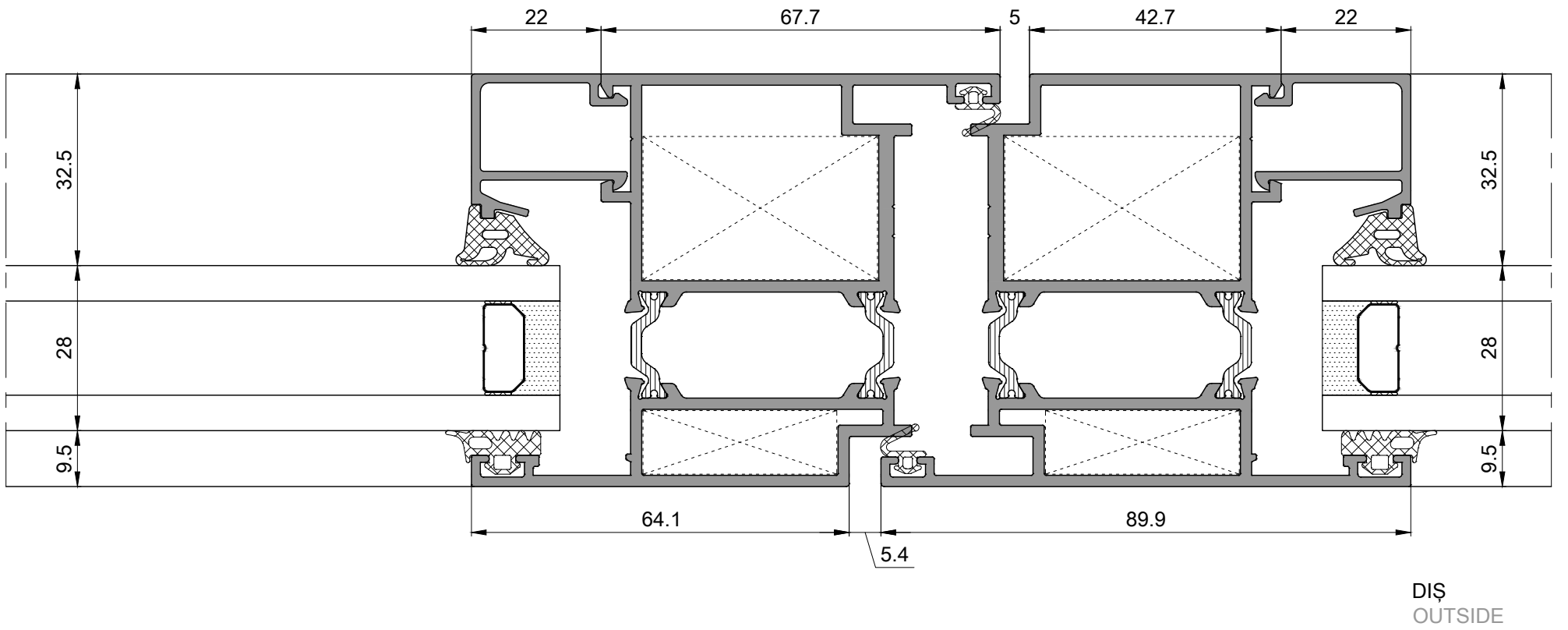

Dışa Açılır Hemyüz Kapı Detayları  
Outward Opening Flush Door Sections

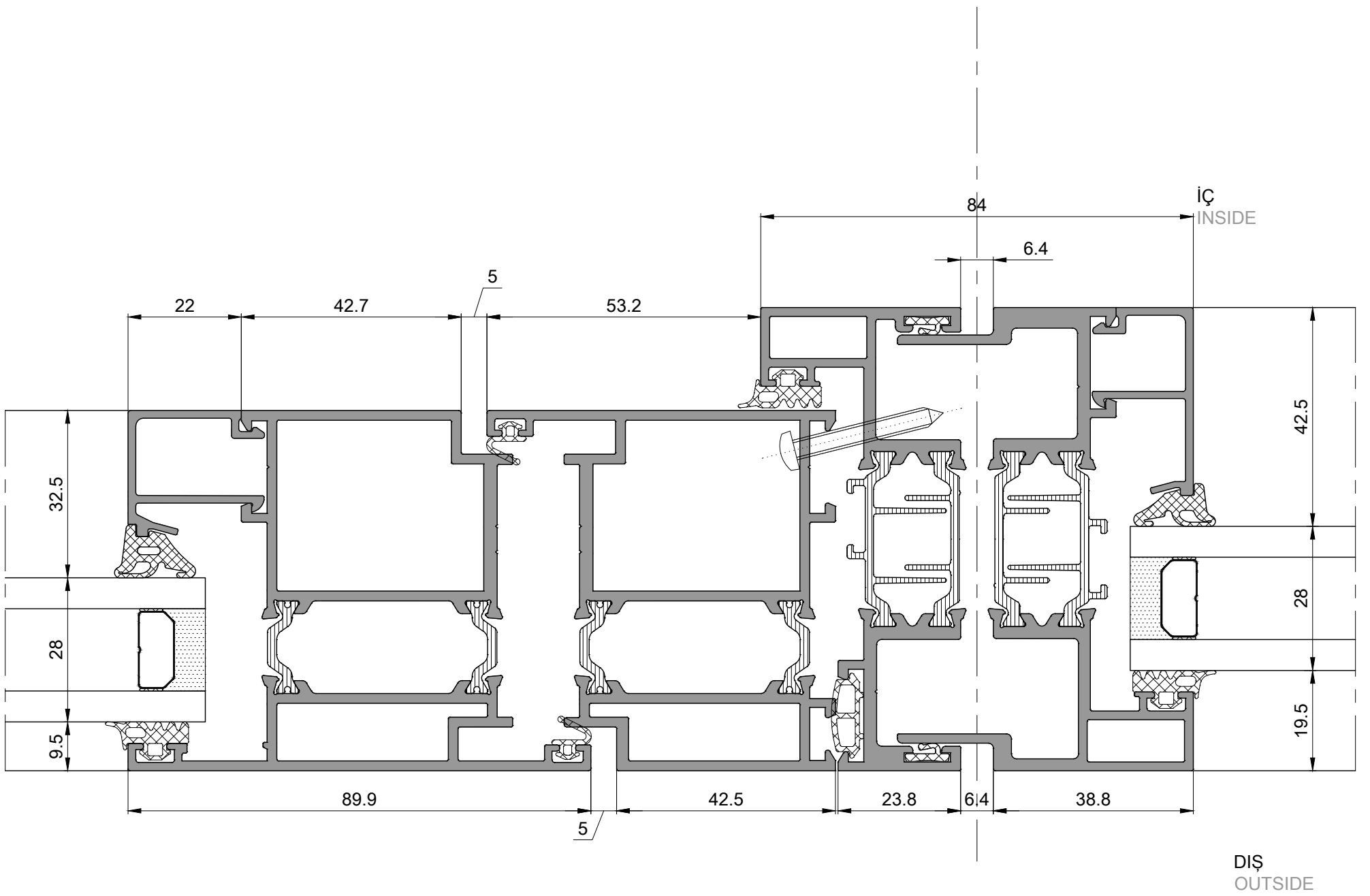
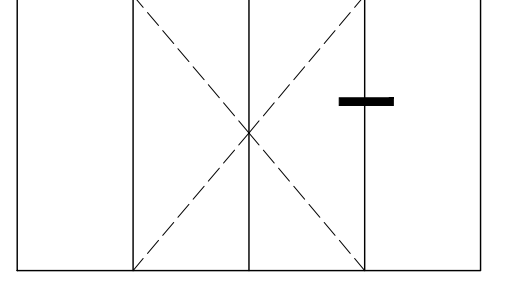

Dışa Açılır Hemyüz Kapı Detayları  
Outward Opening Flush Door Sections

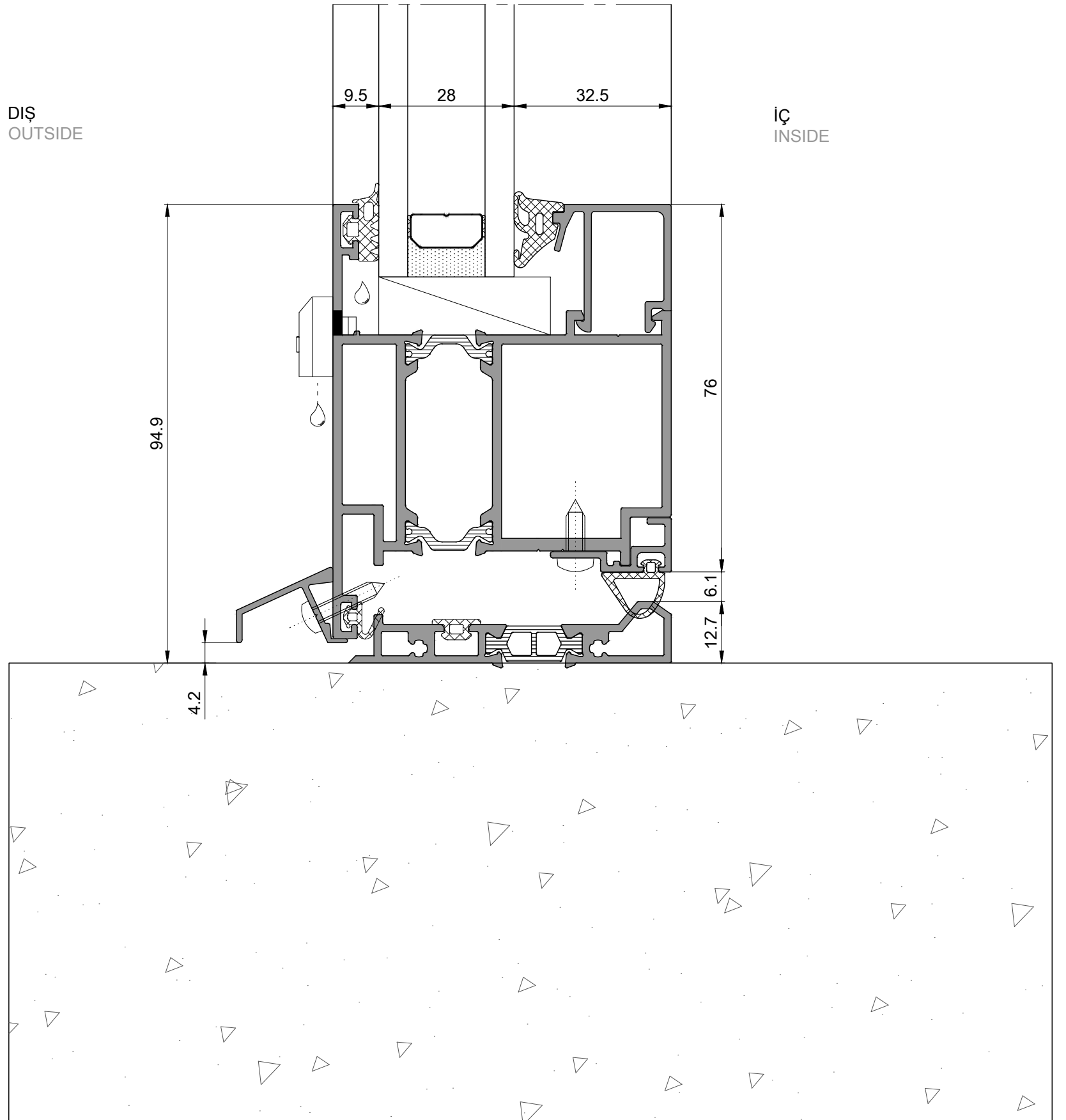
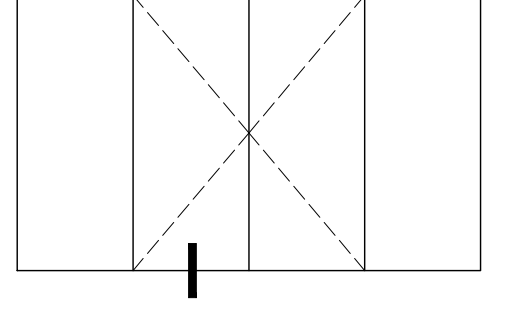

Dışa Açılır Hemyüz Kapı Detayları  
Outward Opening Flush Door Sections

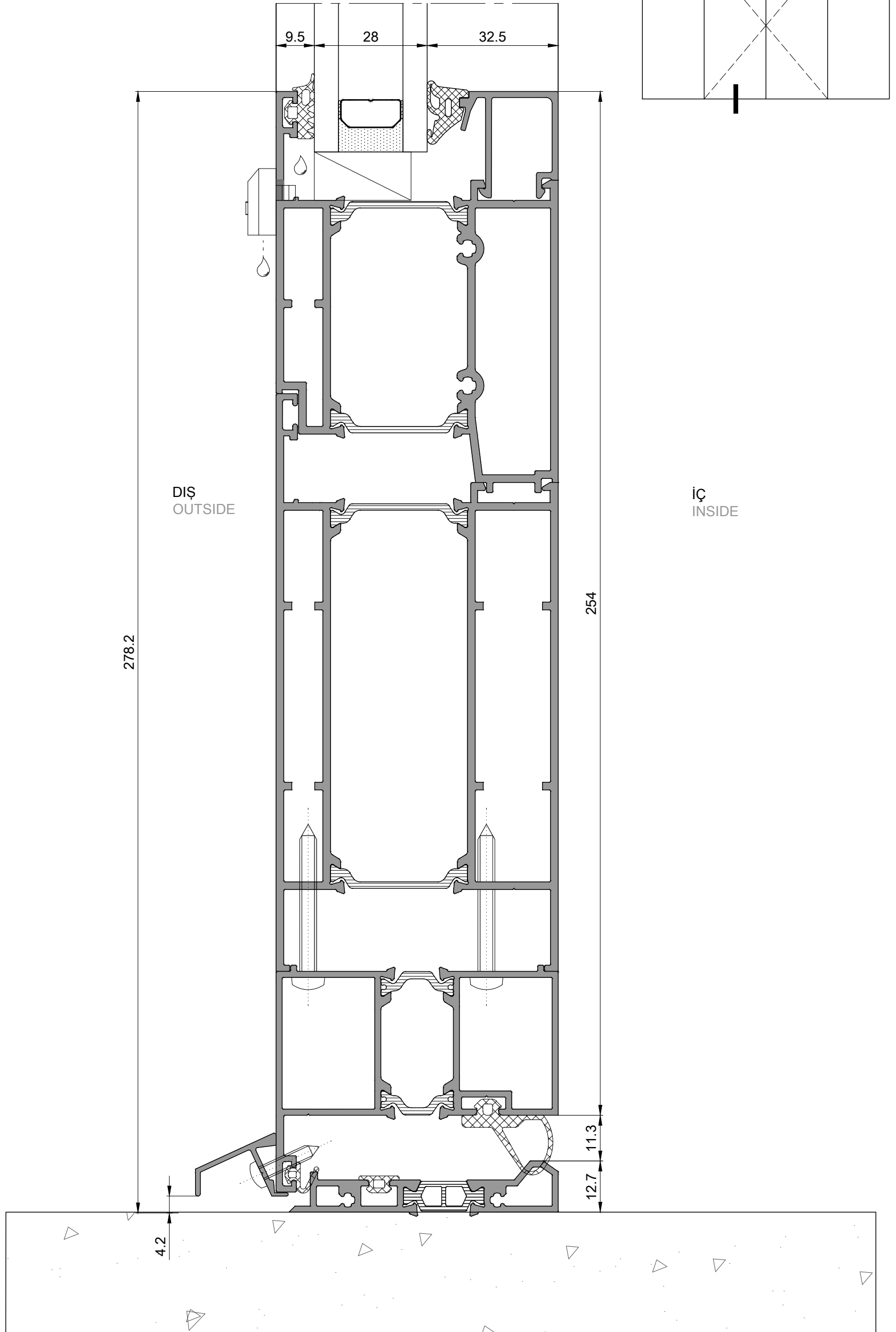

Dışa Açılır Hemyüz Kapı Detayları  
Outward Opening Flush Door Sections

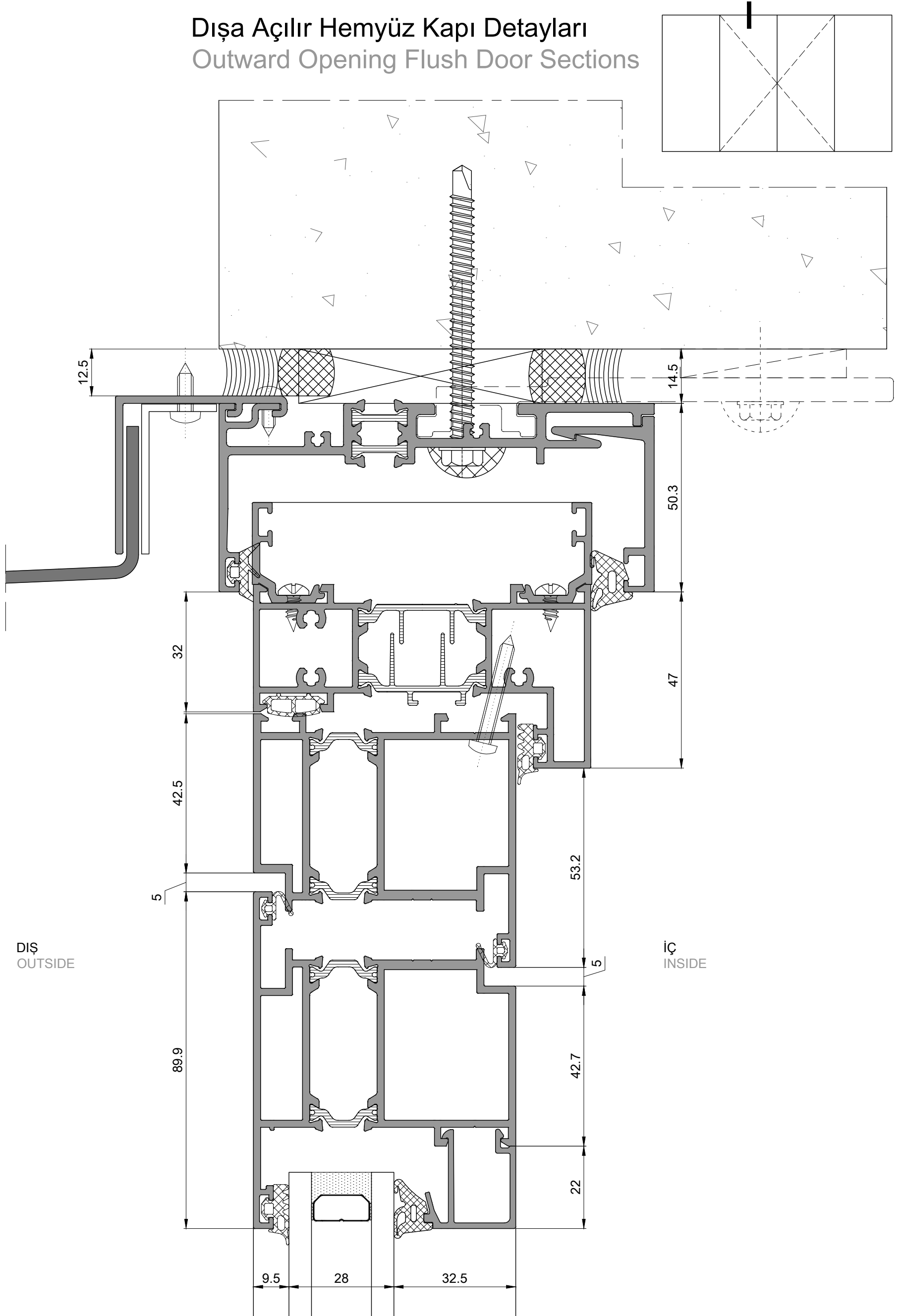







İçe Açılır Hemyüz Kapı Detayları  
Inward Opening Flush Door Sections

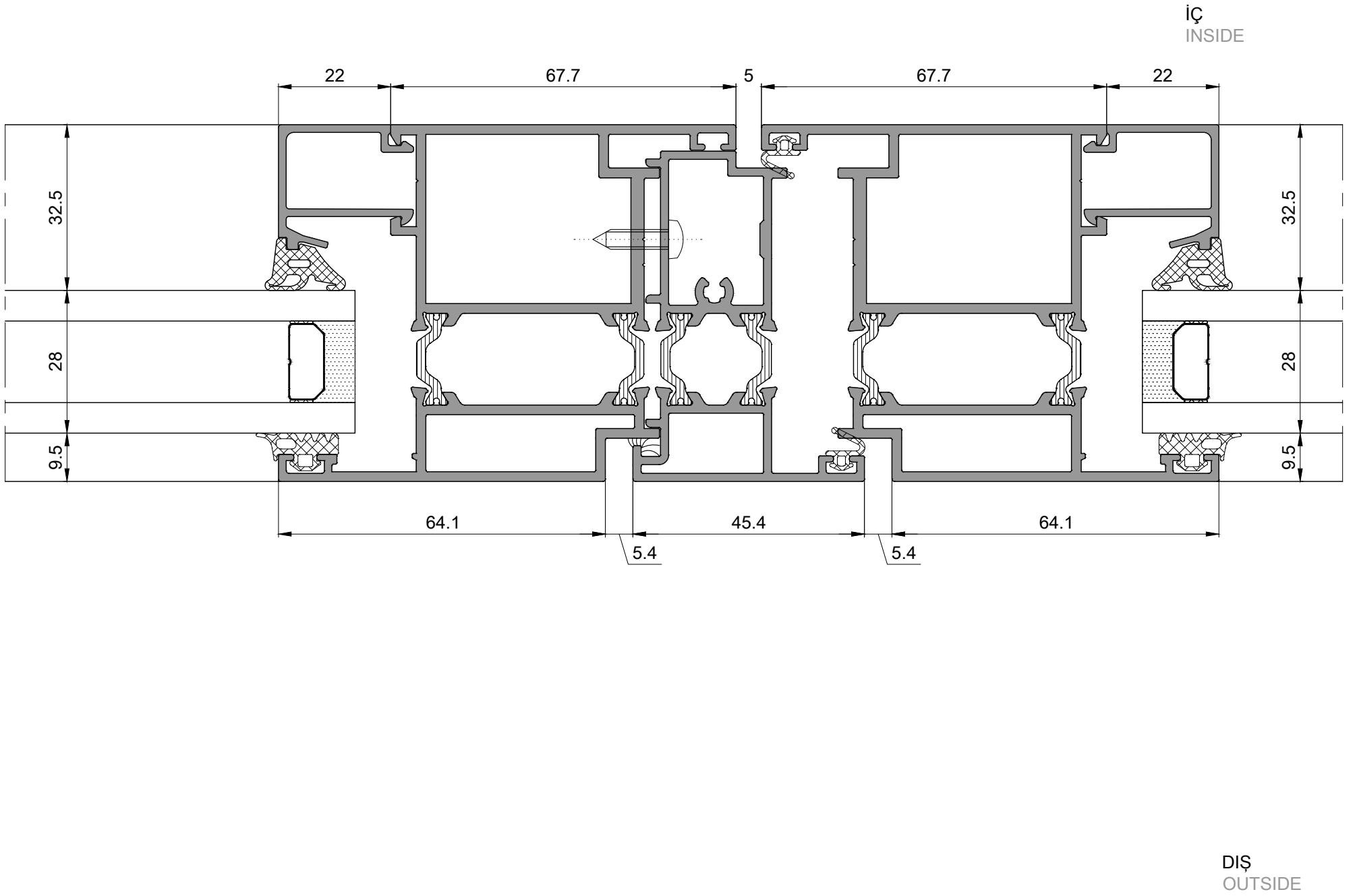
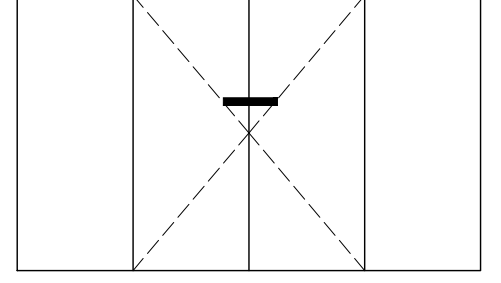

İçe Açılır Hemyüz Kapı Detayları  
Inward Opening Flush Door Sections

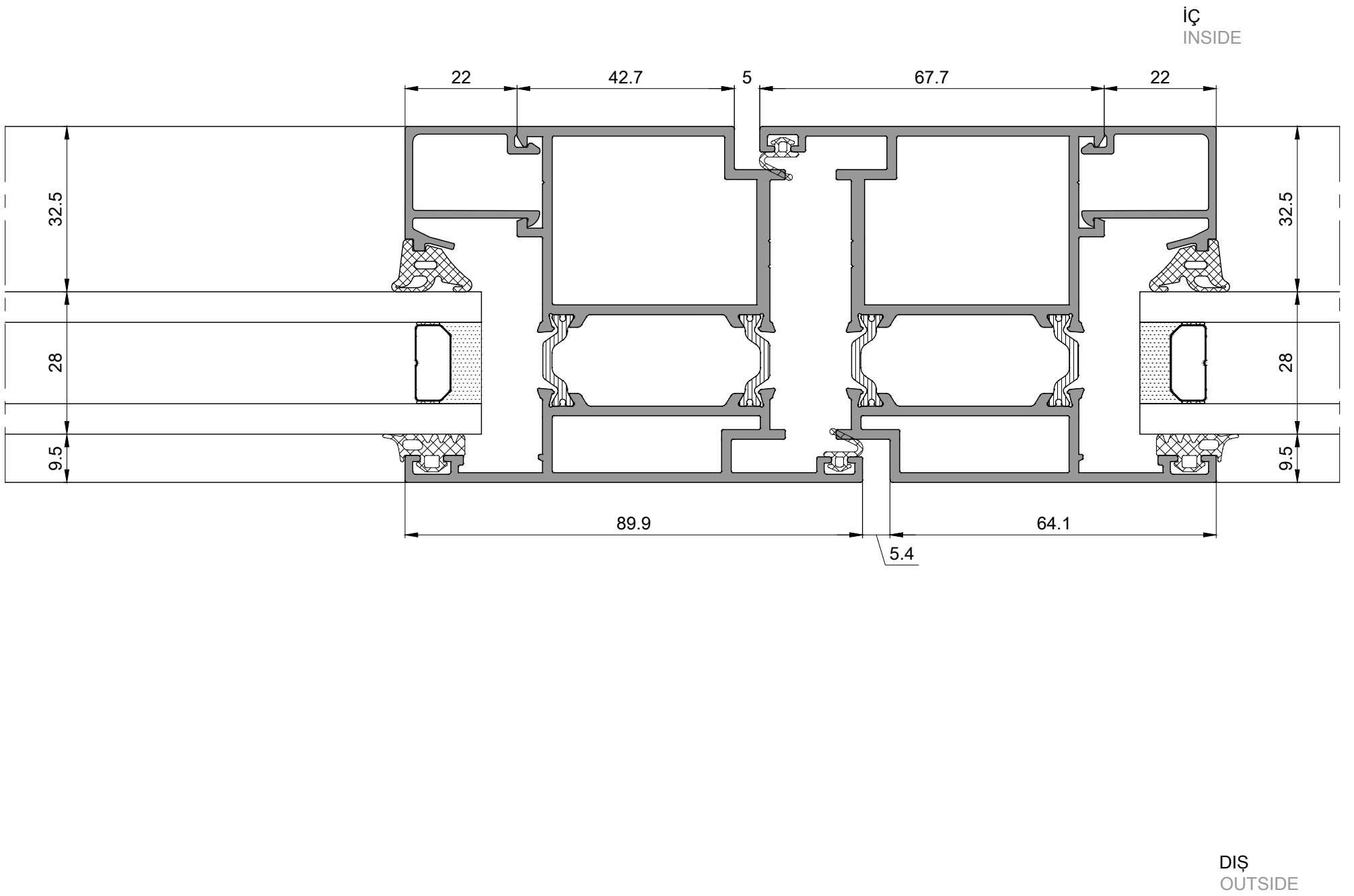

İçe Açılır Hemyüz Kapı Detayları  
Inward Opening Flush Door Sections

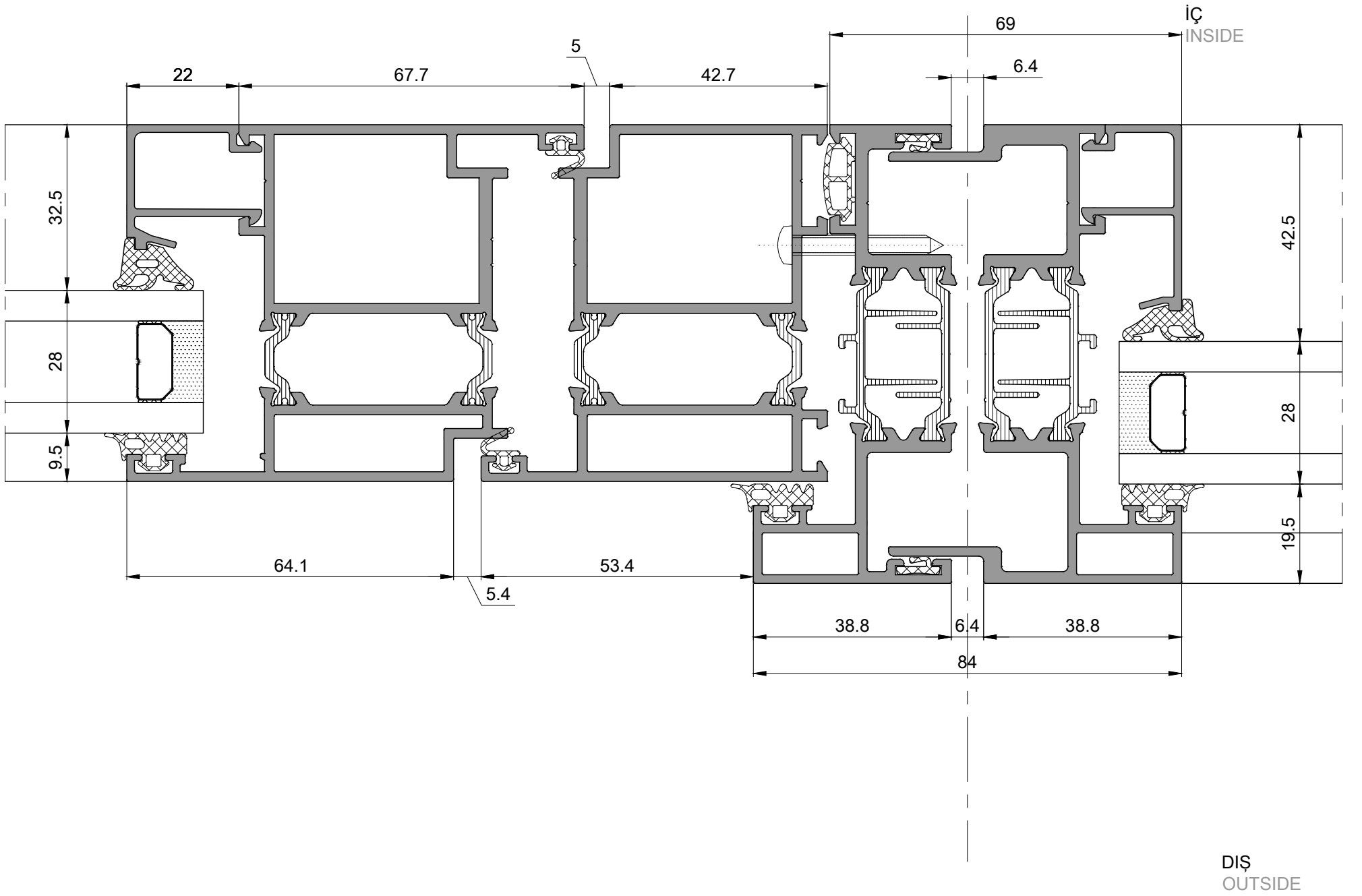
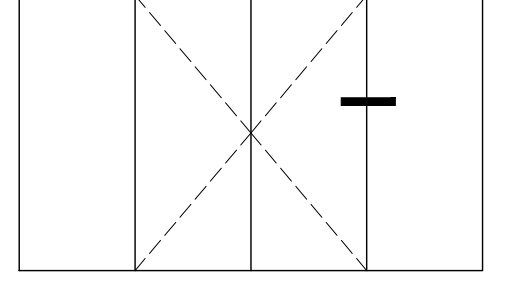

İçe Açılır Hemyüz Kapı Detayları  
Inward Opening Flush Door Sections

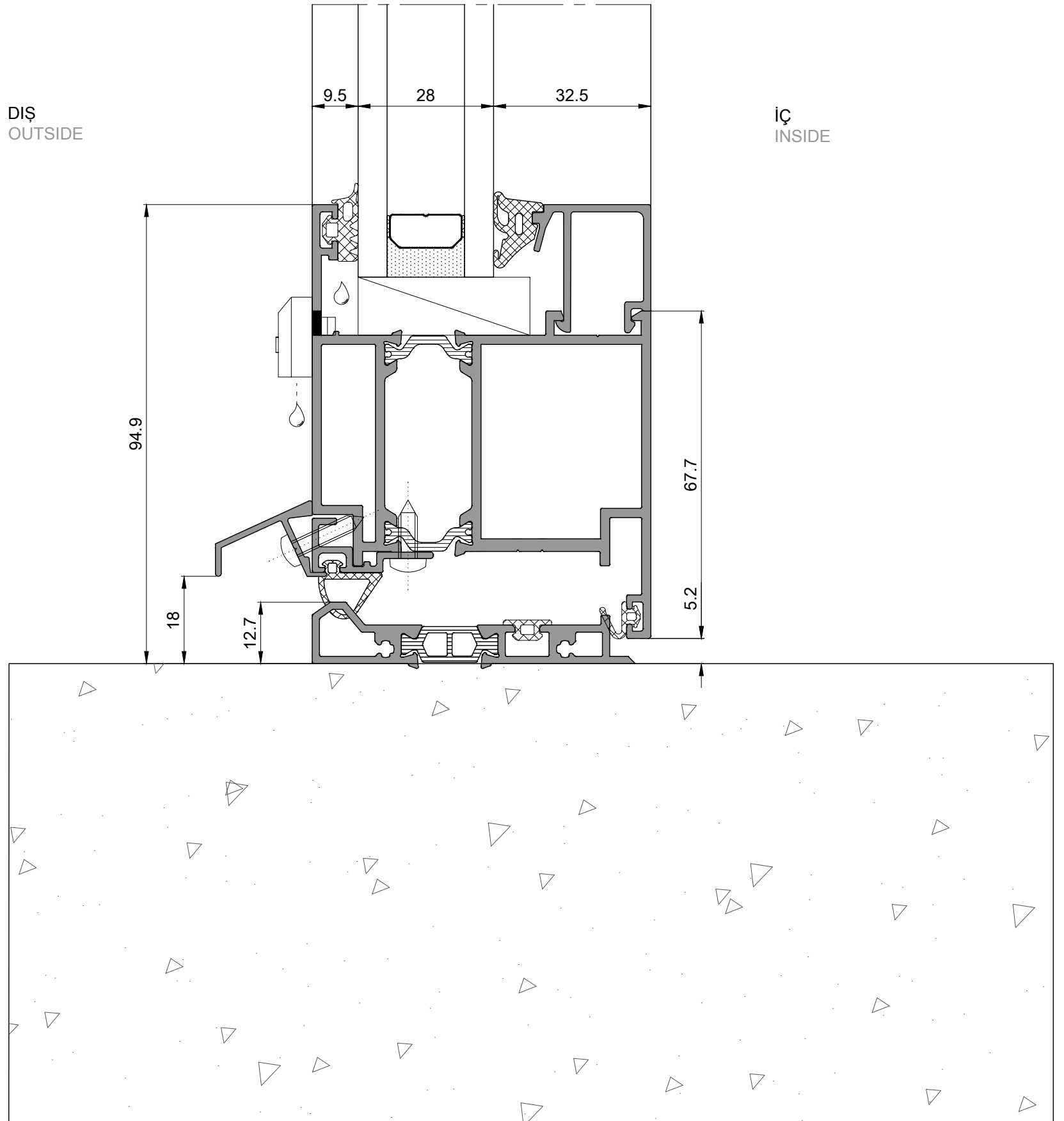
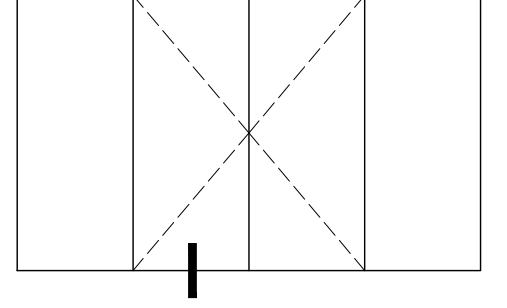

İçe Açılır Hemyüz Kapı Detayları  
Inward Opening Flush Door Sections

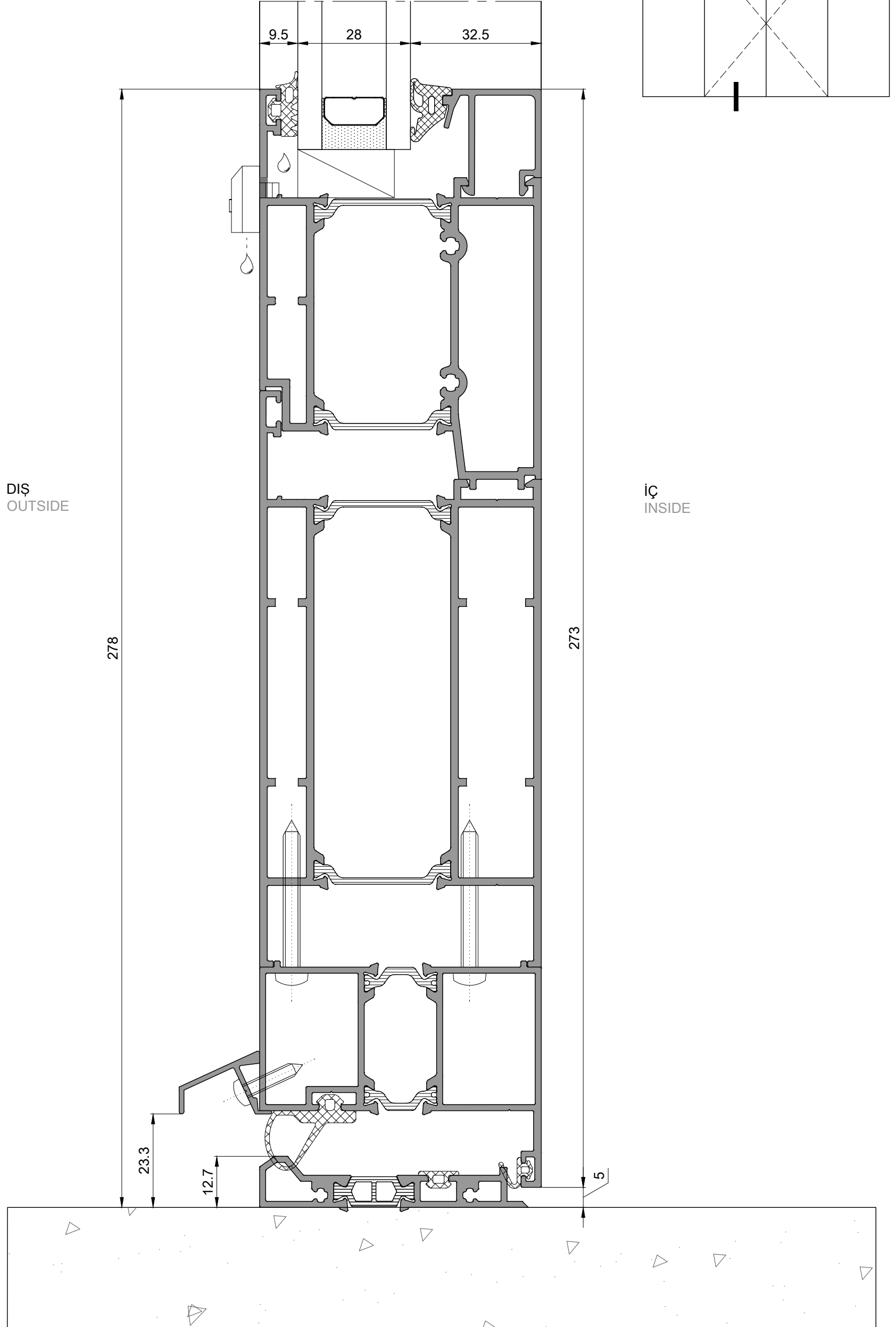

İçe Açılır Hemyüz Kapı Detayları  
Inward Opening Flush Door Sections

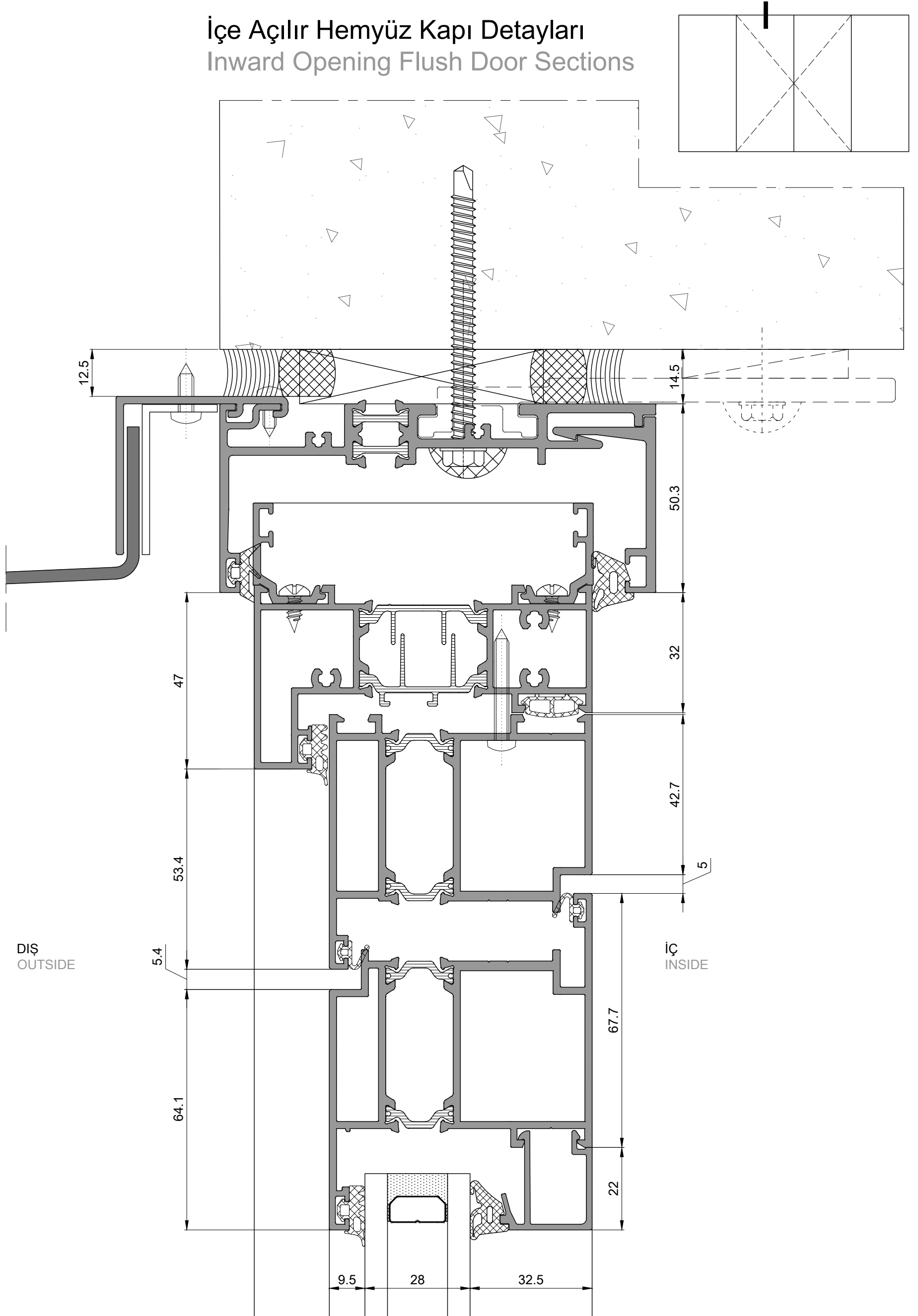

İçe Açılır Hemyüz Kapı Detayları  
Inward Opening Flush Door Sections

