

MOTIONslide
SÜRME KAPI ve PENCERE SİSTEMİ
SLIDING WINDOW and DOOR SYSTEM

A	CAM KOMBİNASYONU ve STATİK DİAGRAM GLASS SELECTION and STATICAL DIAGRAM for SASH	A-01 / A-06
B	ALUMİNYUM PROFİLLER ALUMINIUM PROFILES	B-01 / B-07
C	CONTALAR GASKETS	C-01 / C-02
D	AKSESUARLAR ACCESSORIES	D-01 / D-08
E	AÇILIM TIPLERİ OPENING TYPOLOGY	E-01 / E-03
F	TAM ÖLÇEKLİ PROFİLLER FULL SCALE PROFILES	F-01 / F-17
G	PRENSİP SİSTEM DETAYLARI PRINCIPAL SECTIONS	G-01 / G-111
H	ÜRETİM TALİMATLARI MANUFACTURING INSTRUCTIONS	H-01 / H-53
I	KESİM LİSTELERİ CUTTING FORMULAS	I-01 / I-16

MOTIONslide
SÜRME KAPI ve PENCERE SİSTEMİ
SLIDING WINDOW and DOOR SYSTEM

CAM KOMBİNASYONU ve STATİK DİAGRAM
GLASS SELECTION and STATICAL
DIAGRAM for SASH

Yanda tablodaki veriler teoriktir.
Lütfen cam ve conta toleranslarını dikkate alınız.
selection tables promise a first planning.
Please keep the glass and gasket tolerances in mind.

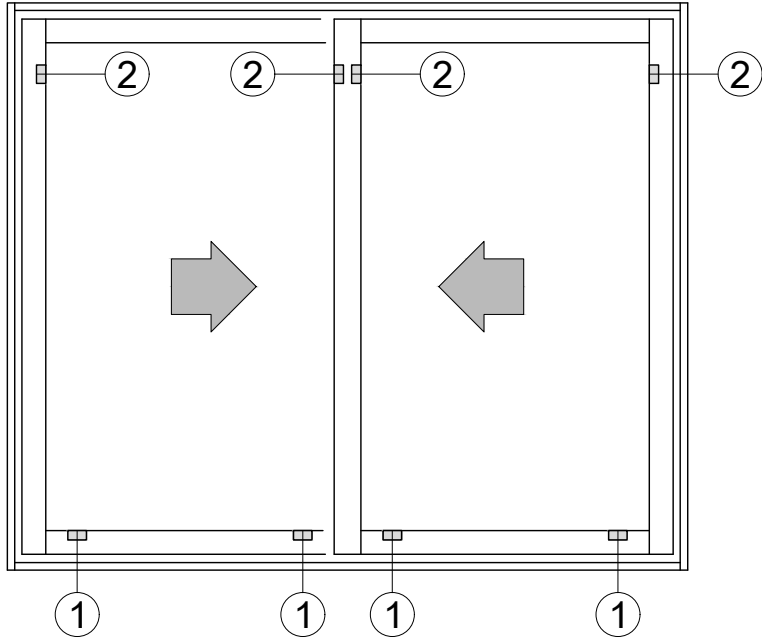

- ① TAŞIYICI TAKOZ
GLASS CLEAT
- ② AYAR TAKOZU
ADJUSTMENT PIECE

① CAM TAKOZU

Cam takozlari yerlesimi altta bulunan sematik çizimde gösterilmistir.
takozların kenara mesafeleri kanat ölçüsünün 5/1 i yada 10/1 i kadar olmalıdır.

GLASS CLEATS

The assembly of glass reinforcement pieces has been showed at the top schemetically. The gap distance to the corner should be, the 5/1 or 10/1 of the sash size.

② MESAFE AYARLAMA TAKOZU

Mesafe ayar takozlari camin alüminyum çerçeve içinde doğru pozisyonda stabil olarak durmasını sağlar.

cam ile profil arasına takozlari zorlamadan yerleştiriniz.

DISTANCE ADJUSTMENT PIECE

Distance adjustment pieces stabilize the glass in the frame at the true position. Put the distance adjustment piece between glass and profile without using force.

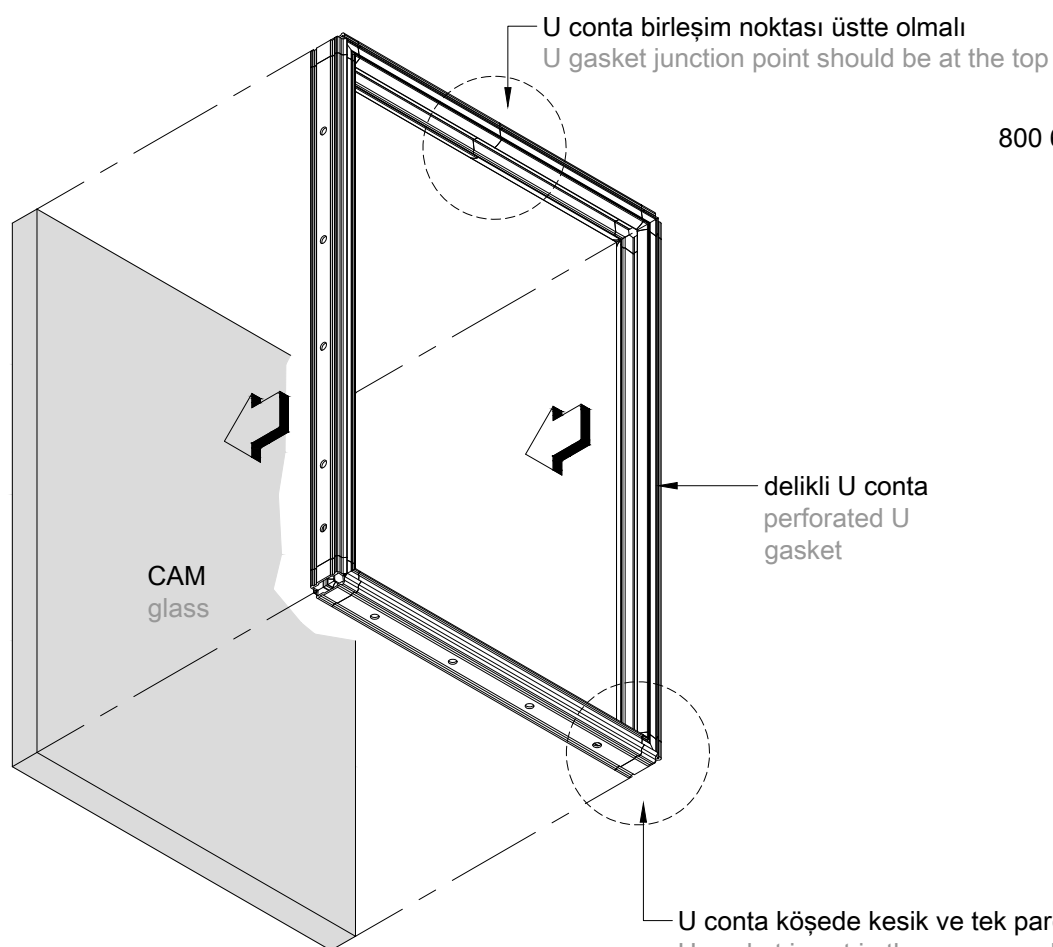
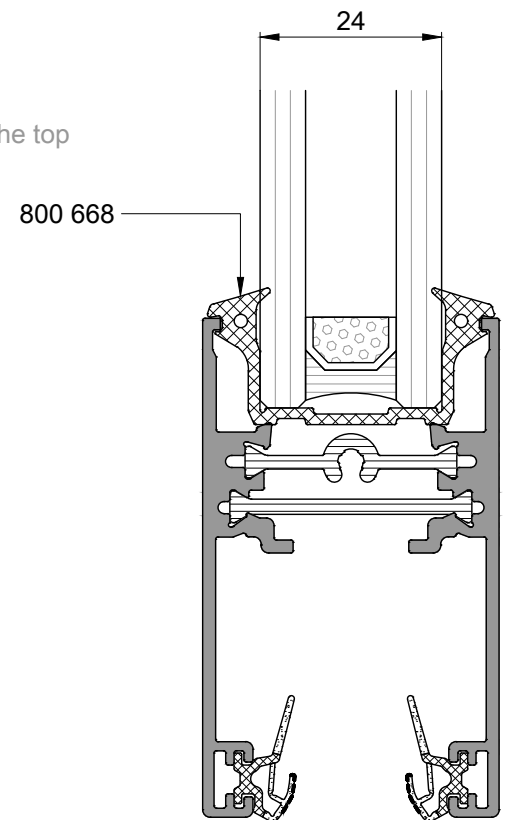
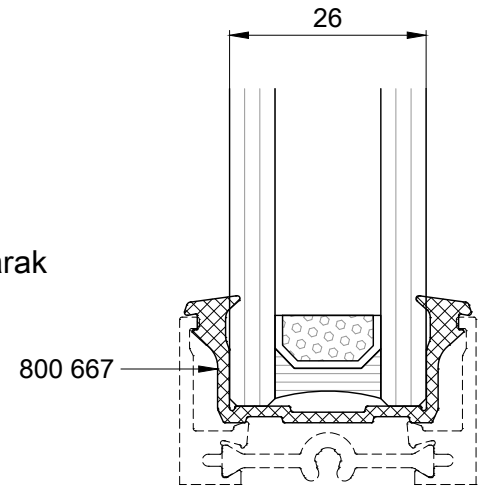
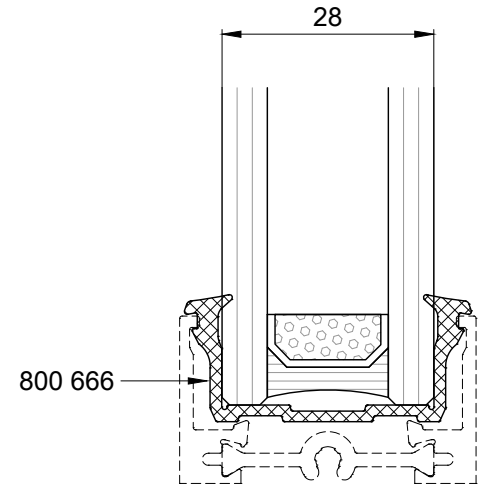
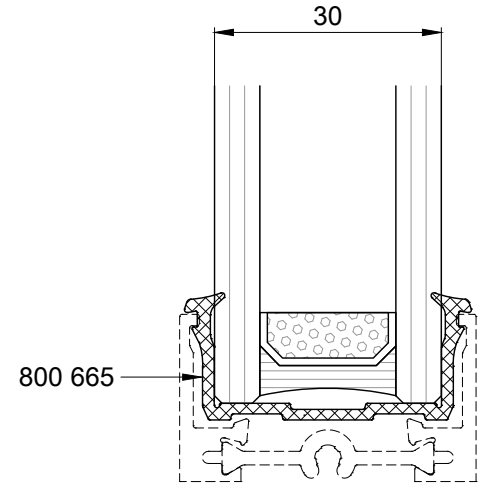

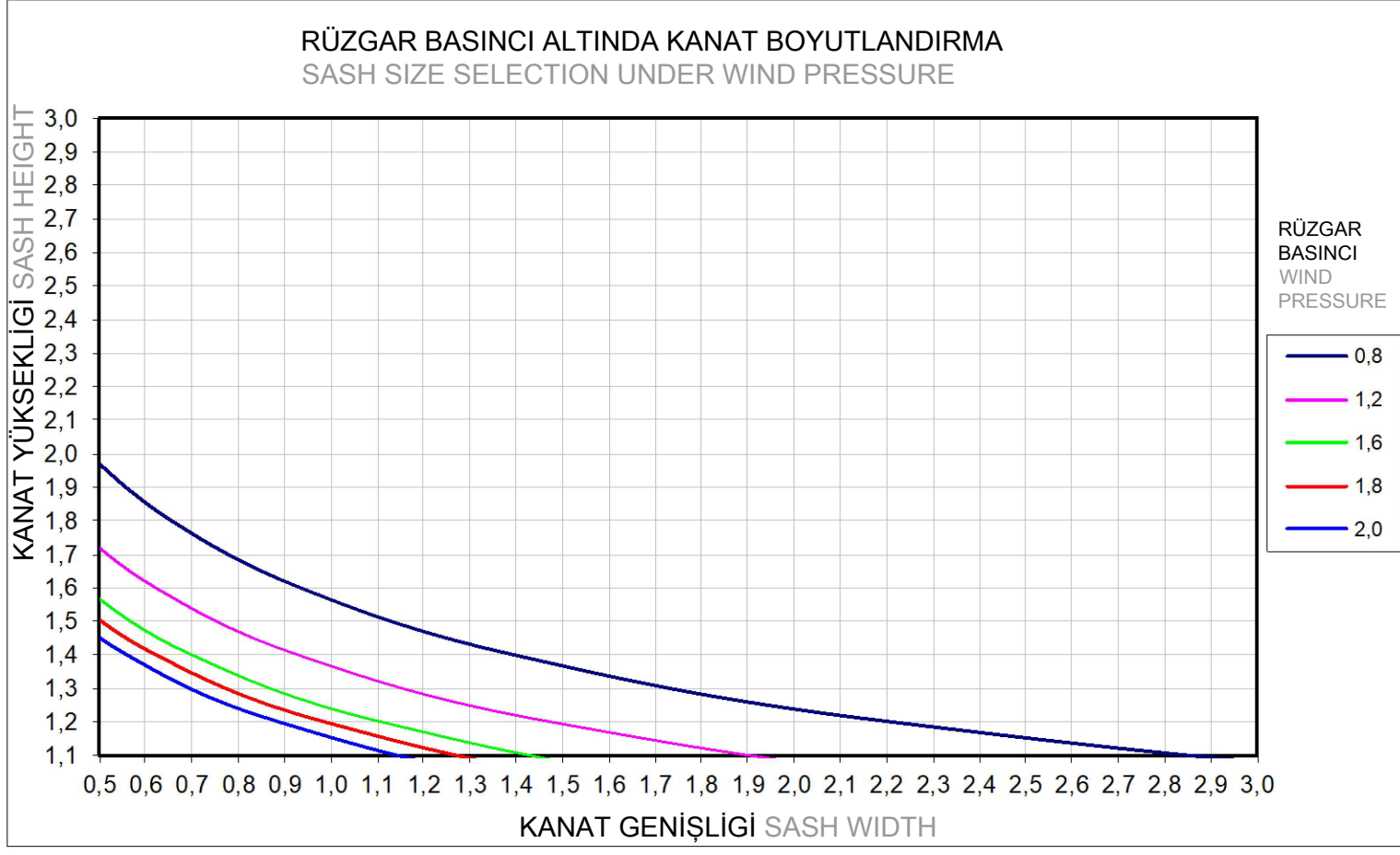

KANAT STATİK DİAGRAM
STATICAL DIAGRAM for SASH

KANAT AĞIRLIĞI : 150kg
SASH WEIGHT : 150kg

SEHİM LİMİTİ L/200 yada 15mm dir.

FARKLI RENKLİ EGRİSEL ÇİZGİLER, FARKLI RÜZGAR BASINLARI ALTINDA, UYGULANABİLİR MAKSİMUM KANAT BOYUTLARINI GÖSTERİR.

ÜSTTEKİ TABLOYA GÖRE SEÇİLEN KANAT BOYUTU, CAM TEDARİKÇİSİNE BİLDİRİLEREK, İZİN VERİLEN BOYUT ve SEHİMİN, SEÇİLEN

CAMA UYGUN OLUP OLMADIĞI TEYİD EDİLMELİ ve ONAY ALINMALIDIR.

DİKKAT:

Bu statik hesap şeması ön yapısal hesaplamalar ve profil seçimi için tasarlanmıştır.

Bu şema nihai yapısal hesaplama için bir alternatif değildir, Statik Rapor olarak kullanılamaz

Statik Hesaplar Mutlaka Uygulamacı Tarafından Yapıtırılmalıdır.

DEFLECTION LIMIT L / 200 or 15mm.

THE LINE SHOW MAXIMUM SIZES FOR THE INDICATE PRESSURE.

VERIFY THAT THE DEFLECTION OF THE SECTION IS COMPATIBLE WITH THE EMPLOYED GLASS.

DIN EN 12210 for the standard building area

Deflection limit L/200 or max. 15mm in accordance with TRLV

Differing deflection limits set by the double glazing manufacturer must be observed.

These statics diagram are intended for preliminary structural calculations and profile selection.

This is not a substitute for a final structural calculation.

Sash sizes below the line are structurally adequate.

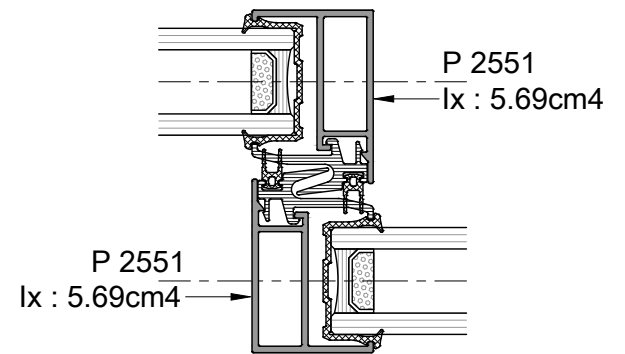
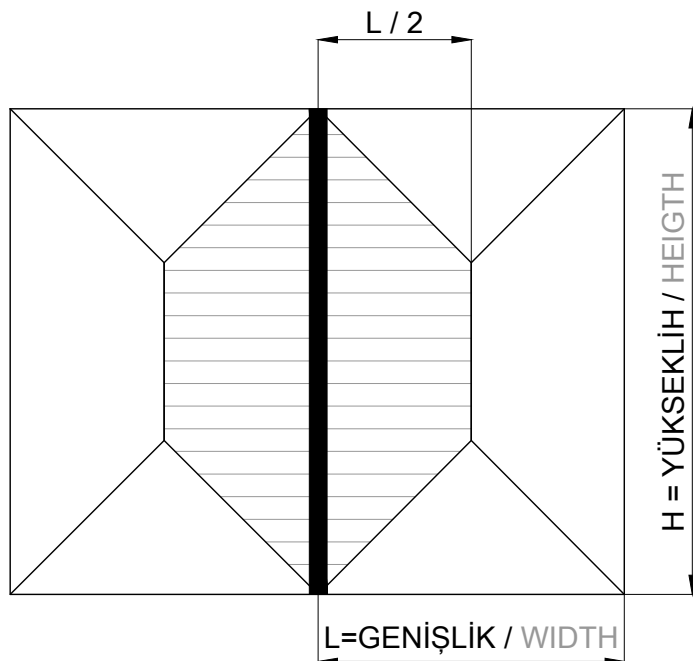

TOTAL Ix: 11,38 cm⁴

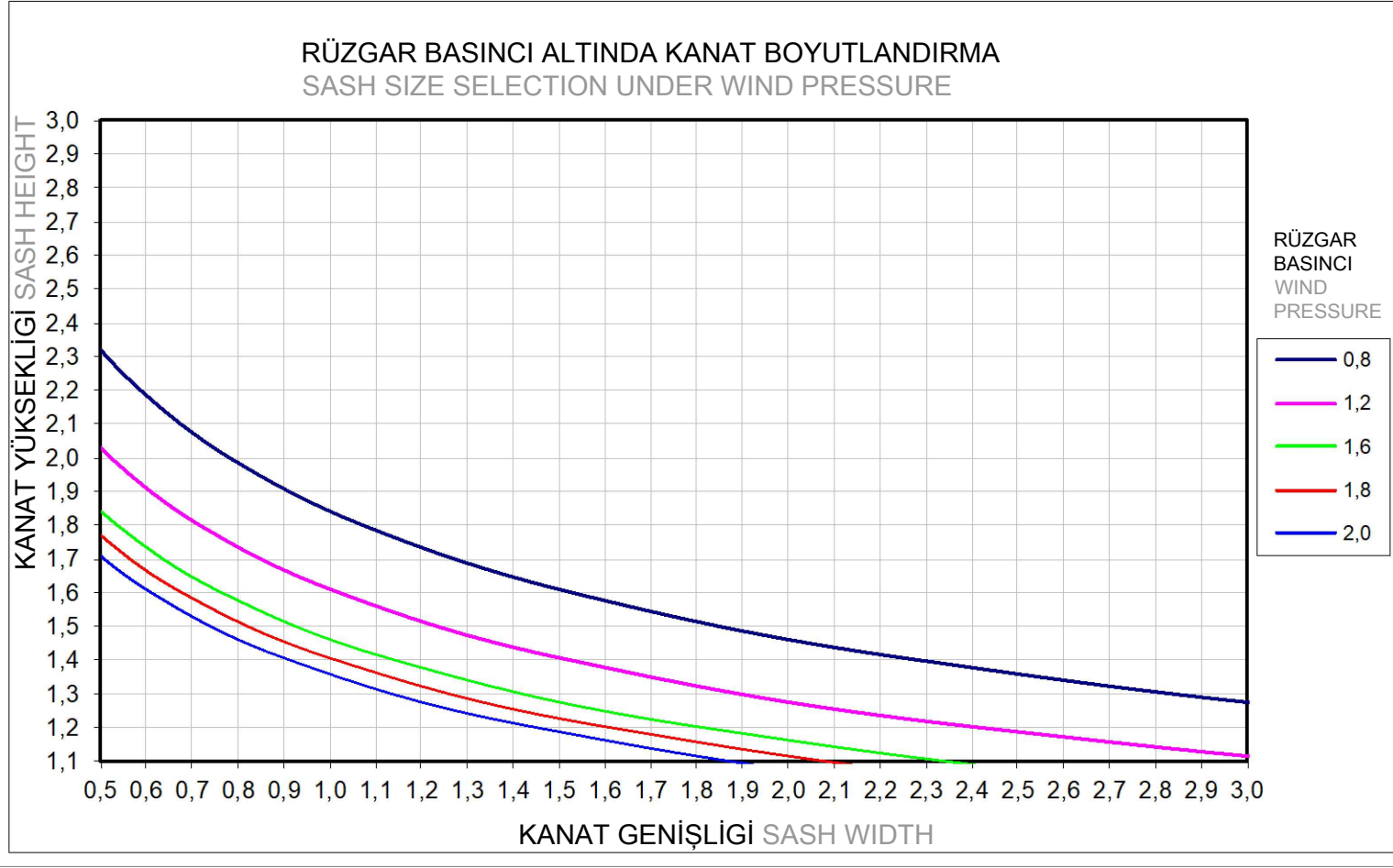

KANAT STATİK DİAGRAM
STATICAL DIAGRAM for SASH

KANAT AĞIRLIĞI : 150kg
SASH WEIGHT : 150kg

SEHİM LİMİTİ L/200 yada 15mm dir.

FARKLI RENKLİ EGRİSEL ÇİZGİLER, FARKLI RÜZGAR BASINLARI ALTINDA, UYGULANABİLİR MAKSİMUM KANAT BOYUTLARINI GÖSTERİR.

ÜSTTEKİ TABLOYA GÖRE SEÇİLEN KANAT BOYUTU, CAM TEDARİKÇİSİNE BİLDİRİLEREK, İZİN VERİLEN BOYUT ve SEHİMİN, SEÇİLEN

CAMA UYGUN OLUP OLMADIĞI TEYİD EDİLMELİ ve ONAY ALINMALIDIR.

DİKKAT:

Bu statik hesap şeması ön yapısal hesaplamalar ve profil seçimi için tasarlanmıştır.

Bu şema nihai yapısal hesaplama için bir alternatif değildir, Statik Rapor olarak kullanılamaz

Statik Hesaplar Mutlaka Uygulamacı Tarafından Yapıtırılmalıdır.

DEFLECTION LIMIT L / 200 or 15mm.

THE LINE SHOW MAXIMUM SIZES FOR THE INDICATE PRESSURE.

VERIFY THAT THE DEFLECTION OF THE SECTION IS COMPATIBLE WITH THE EMPLOYED GLASS.

DIN EN 12210 for the standard building area

Deflection limit L/200 or max. 15mm in accordance with TRLV

Differing deflection limits set by the double glazing manufacturer must be observed.

These statics diagram are intended for preliminary structural calculations and profile selection.

This is not a substitute for a final structural calculation.

Sash sizes below the line are structurally adequate.

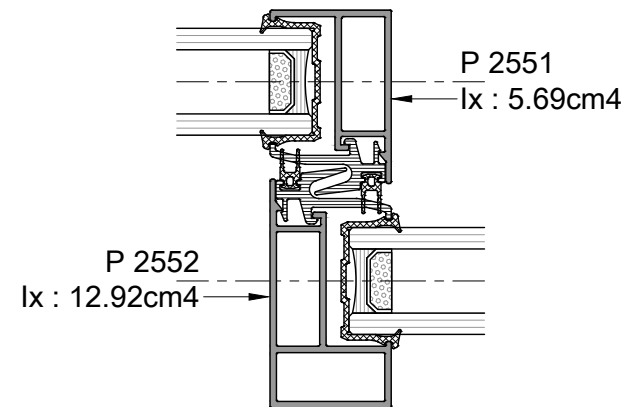
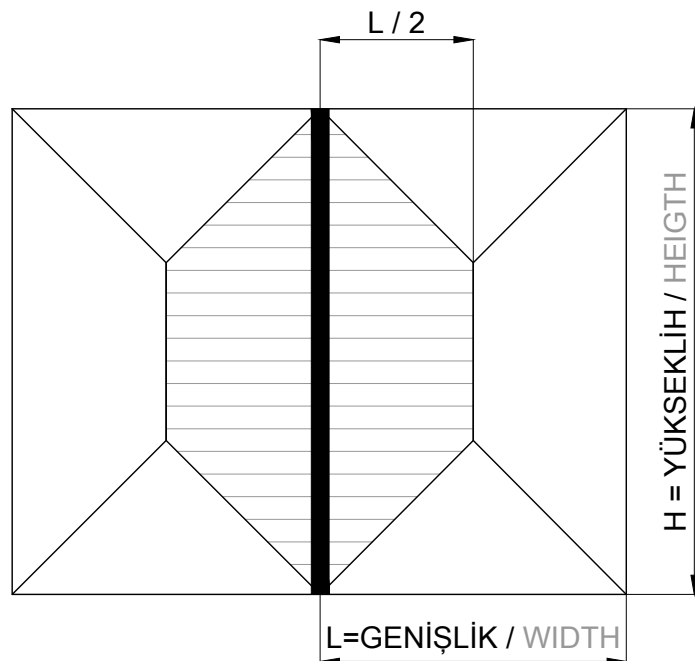

TOTAL Ix: 18,61 cm4

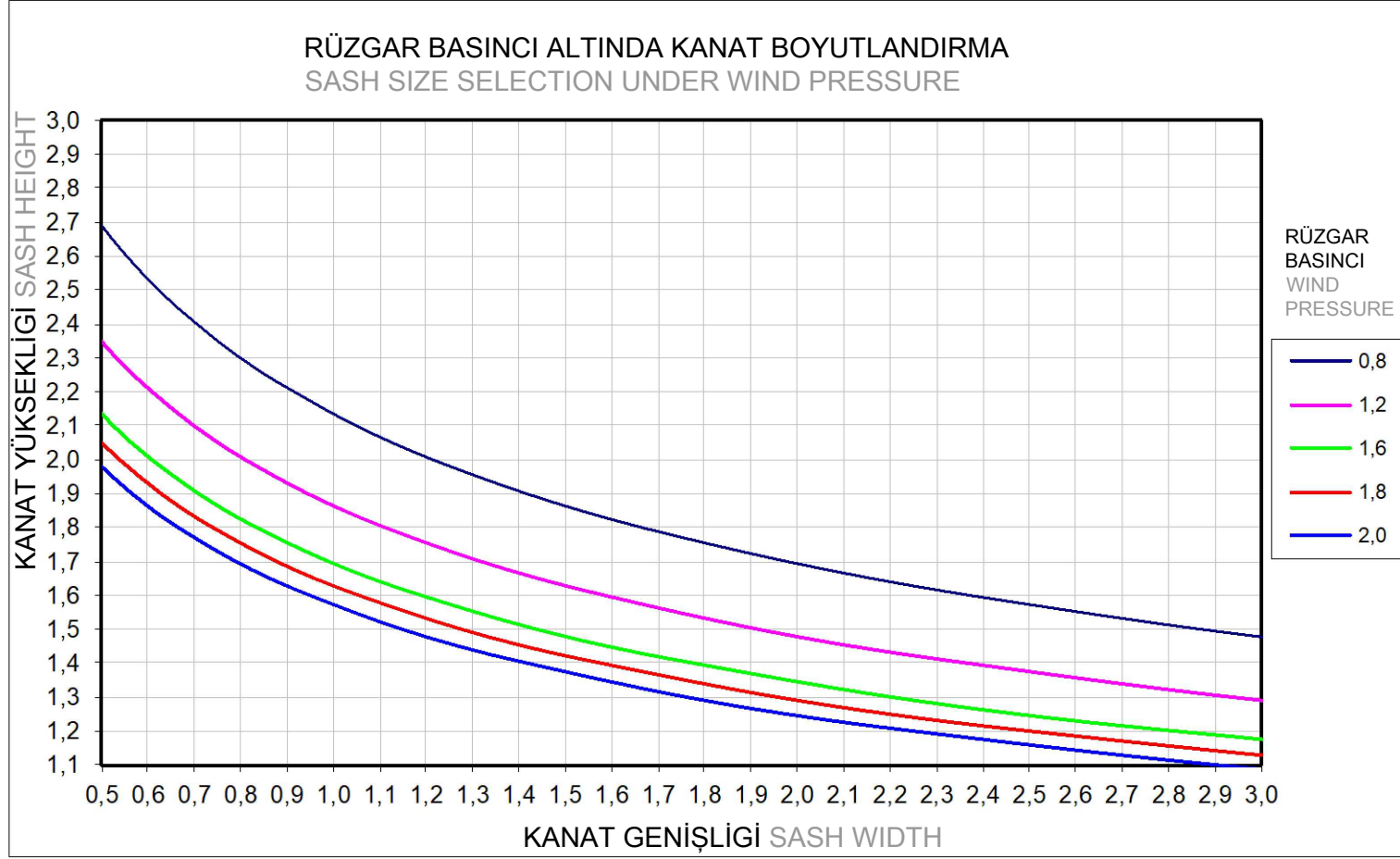

KANAT STATİK DİAGRAM
STATICAL DIAGRAM for SASH

KANAT AĞIRLIĞI : 150kg
SASH WEIGHT : 150kg

SEHİM LİMİTİ L/200 yada 15mm dir.

FARKLI RENKLİ EGRİSEL ÇİZGİLER, FARKLI RÜZGAR BASINCLARI ALTINDA, UYGULANABİLİR MAKSİMUM KANAT BOYUTLARINI GÖSTERİR.

ÜSTTEKİ TABLOYA GÖRE SEÇİLEN KANAT BOYUTU, CAM TEDARİKÇİSİNE BİLDİRİLEREK, İZİN VERİLEN BOYUT ve SEHİMİN, SEÇİLEN

CAMA UYGUN OLUP OLMADIĞI TEYİD EDİLMELİ ve ONAY ALINMALIDIR.

DİKKAT:

Bu statik hesap şeması ön yapısal hesaplamalar ve profil seçimi için tasarlanmıştır.

Bu şema nihai yapısal hesaplama için bir alternatif değildir, Statik Rapor olarak kullanılamaz

Statik Hesaplar Mutlaka Uygulamacı Tarafından Yapıtırılmalıdır.

DEFLECTION LIMIT L / 200 or 15mm.

THE LINE SHOW MAXIMUM SIZES FOR THE INDICATE PRESSURE.

VERIFY THAT THE DEFLECTION OF THE SECTION IS COMPATIBLE WITH THE EMPLOYED GLASS.

DIN EN 12210 for the standard building area

Deflection limit L/200 or max. 15mm in accordance with TRLV

Differing deflection limits set by the double glazing manufacturer must be observed.

These statics diagram are intended for preliminary structural calculations and profile selection.

This is not a substitute for a final structural calculation.

Sash sizes below the line are structurally adequate.

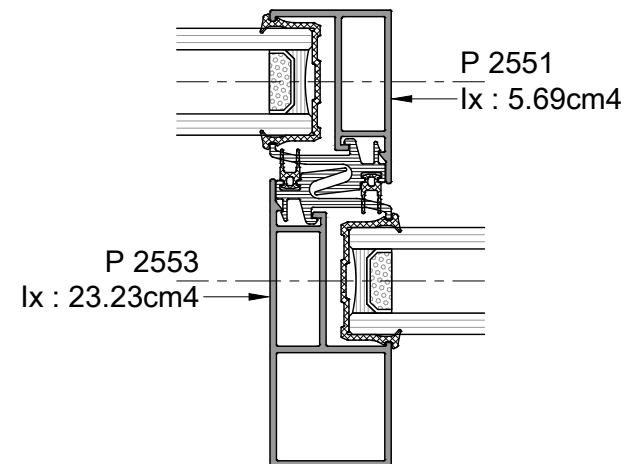
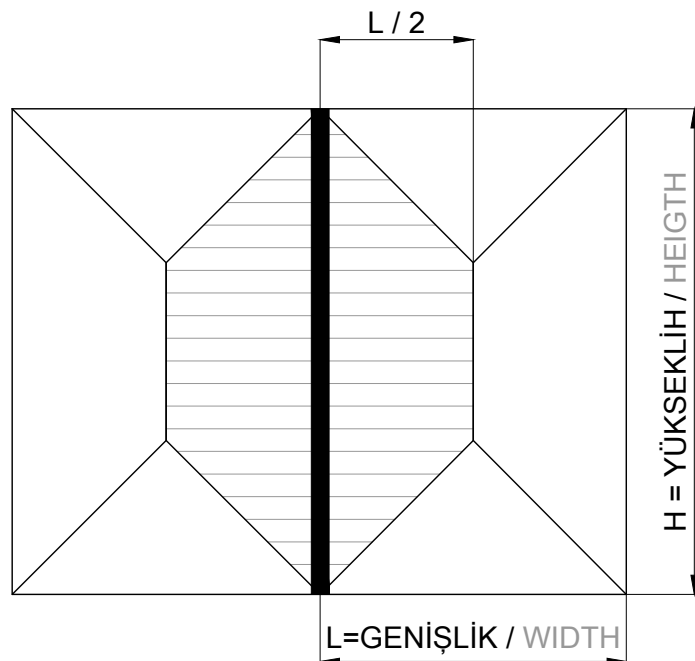

TOTAL Ix: 28,92 cm4

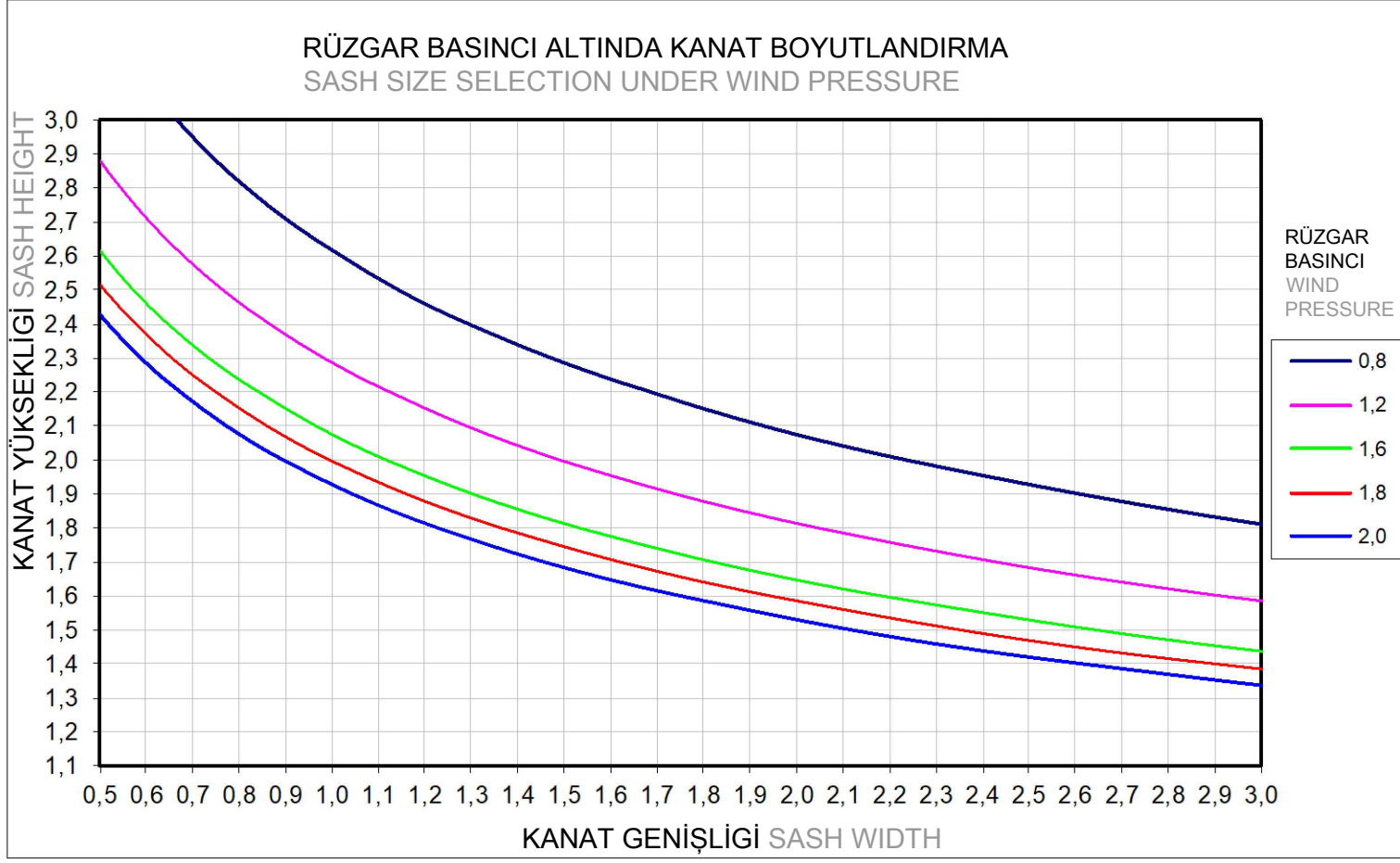

KANAT STATİK DİAGRAM
STATICAL DIAGRAM for SASH

KANAT AĞIRLIĞI : 150kg
SASH WEIGHT : 150kg

SEHİM LİMİTİ L/200 yada 15mm dir.

FARKLI RENKLİ EGRİSEL ÇİZGİLER, FARKLI RÜZGAR BASINLARI ALTINDA, UYGULANABİLİR MAKSİMUM KANAT BOYUTLARINI GÖSTERİR.

ÜSTTEKİ TABLOYA GÖRE SEÇİLEN KANAT BOYUTU, CAM TEDARİKÇİSİNE BİLDİRİLEREK, İZİN VERİLEN BOYUT ve SEHİMİN, SEÇİLEN

CAMA UYGUN OLUP OLMADIĞI TEYİD EDİLMELİ ve ONAY ALINMALIDIR.

DİKKAT:

Bu statik hesap şeması ön yapısal hesaplamalar ve profil seçimi için tasarlanmıştır.

Bu şema nihai yapısal hesaplama için bir alternatif değildir, Statik Rapor olarak kullanılamaz

Statik Hesaplar Mutlaka Uygulamacı Tarafından Yapıtırılmalıdır.

DEFLECTION LIMIT L / 200 or 15mm.

THE LINE SHOW MAXIMUM SIZES FOR THE INDICATE PRESSURE.

VERIFY THAT THE DEFLECTION OF THE SECTION IS COMPATIBLE WITH THE EMPLOYED GLASS.

DIN EN 12210 for the standard building area

Deflection limit L/200 or max. 15mm in accordance with TRLV

Differing deflection limits set by the double glazing manufacturer must be observed.

These statics diagram are intended for preliminary structural calculations and profile selection.

This is not a substitute for a final structural calculation.

Sash sizes below the line are structurally adequate.

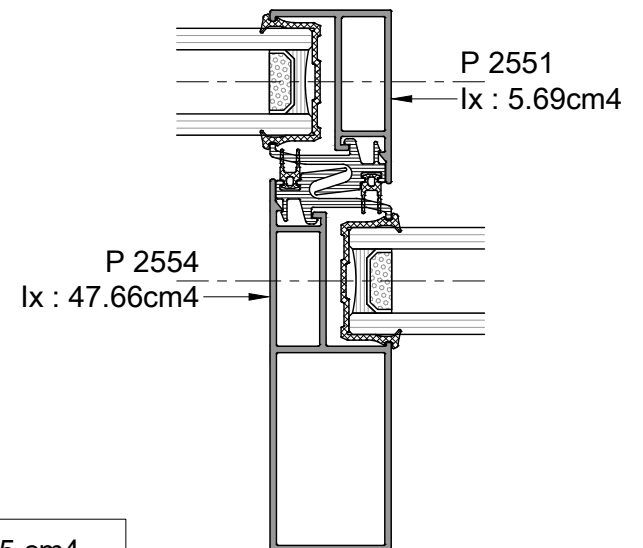
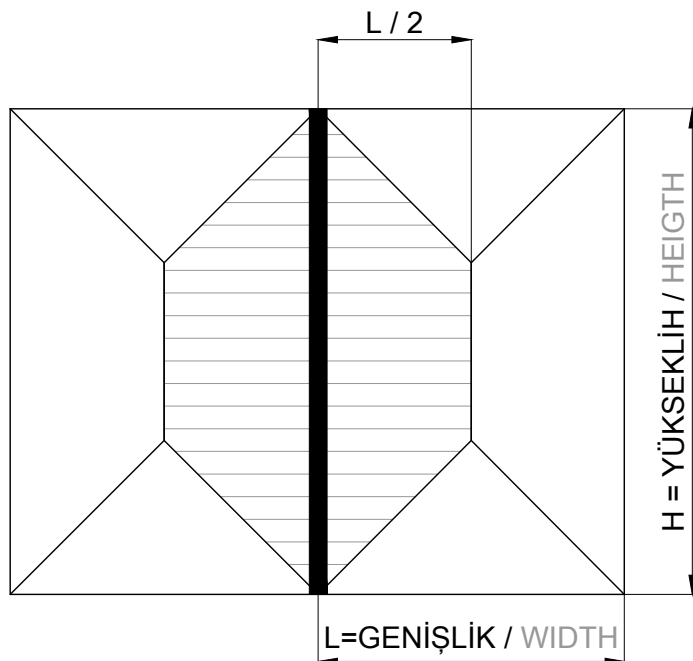

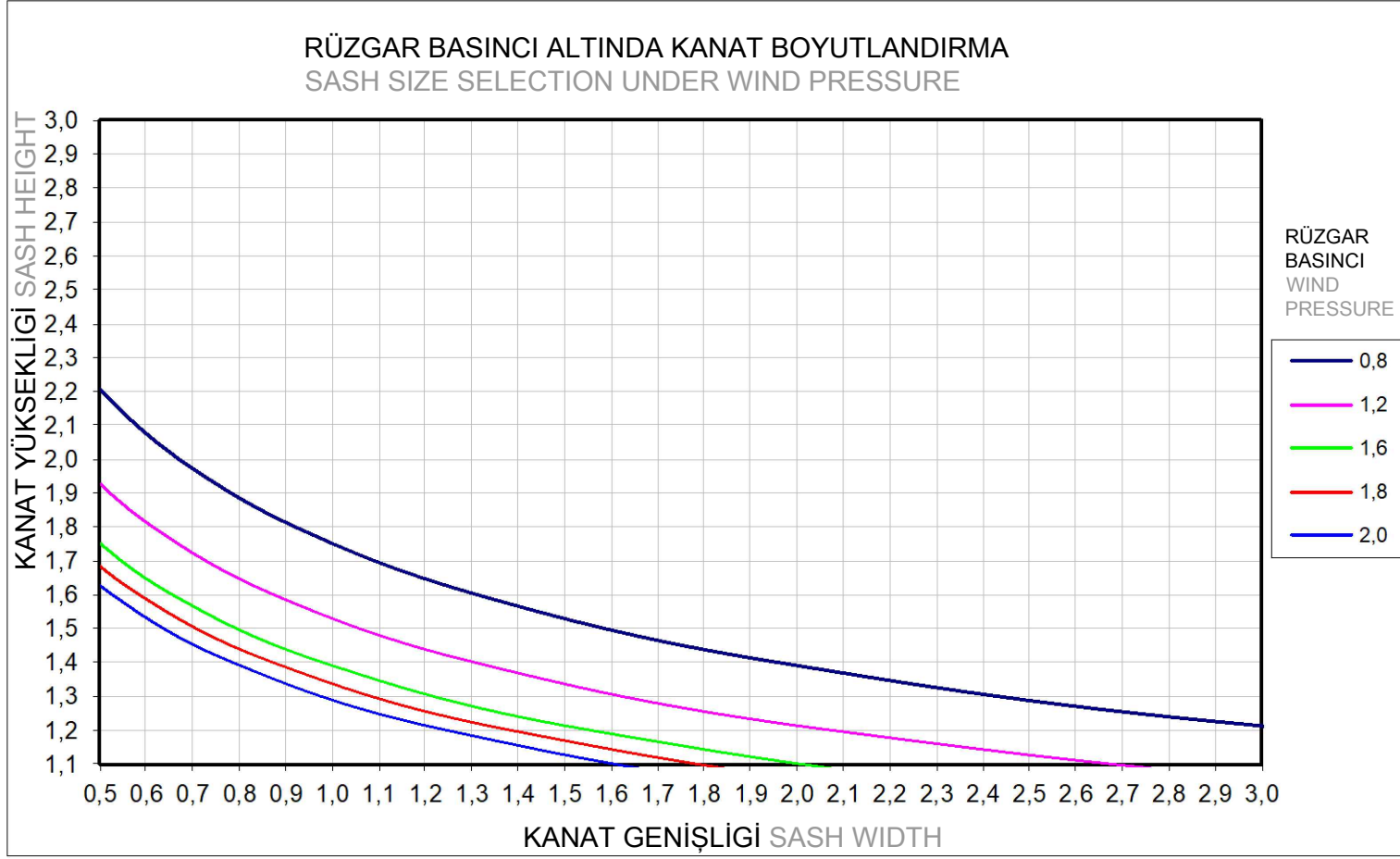

KANAT STATİK DİAGRAM
STATICAL DIAGRAM for SASH

KANAT AĞIRLIĞI : 150kg
SASH WEIGHT : 150kg

SEHİM LİMİTİ L/200 yada 15mm dir.

FARKLI RENKLİ EGRİSEL ÇİZGİLER, FARKLI RÜZGAR BASINLARI ALTINDA, UYGULANABİLİR MAKSİMUM KANAT BOYUTLARINI GÖSTERİR.

ÜSTTEKİ TABLOYA GÖRE SEÇİLEN KANAT BOYUTU, CAM TEDARİKÇİSİNE BİLDİRİLEREK, İZİN VERİLEN BOYUT ve SEHİMİN, SEÇİLEN

CAMA UYGUN OLUP OLMADIĞI TEYİD EDİLMELİ ve ONAY ALINMALIDIR.

DİKKAT:

Bu statik hesap şeması ön yapısal hesaplamalar ve profil seçimi için tasarlanmıştır.

Bu şema nihai yapısal hesaplama için bir alternatif değildir, Statik Rapor olarak kullanılamaz

Statik Hesaplar Mutlaka Uygulamacı Tarafından Yapıtırılmalıdır.

DEFLECTION LIMIT L / 200 or 15mm.

THE LINE SHOW MAXIMUM SIZES FOR THE INDICATE PRESSURE.

VERIFY THAT THE DEFLECTION OF THE SECTION IS COMPATIBLE WITH THE EMPLOYED GLASS.

DIN EN 12210 for the standard building area

Deflection limit L/200 or max. 15mm in accordance with TRLV

Differing deflection limits set by the double glazing manufacturer must be observed.

These statics diagram are intended for preliminary structural calculations and profile selection.

This is not a substitute for a final structural calculation.

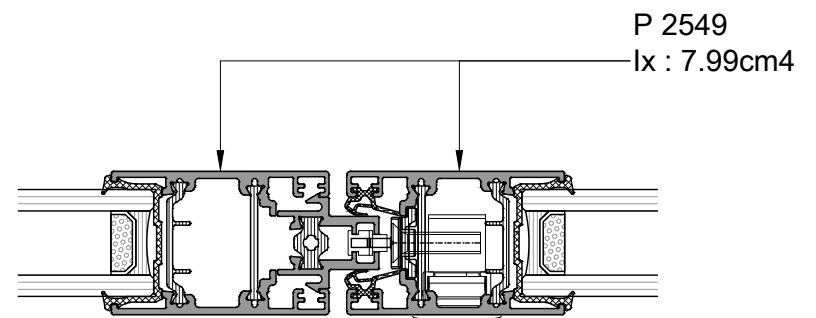
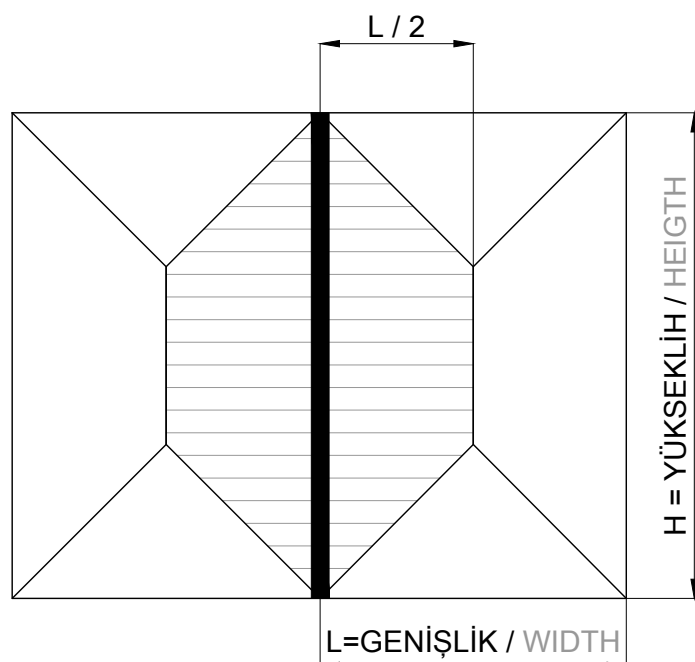

Sash sizes below the line are structurally adequate.







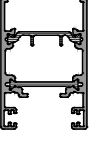
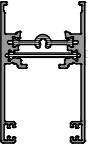
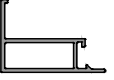

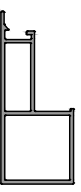
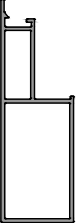
TOTAL Ix: 15,98 cm4

MOTIONslide
SÜRME KAPI ve PENCERE SİSTEMİ
SLIDING WINDOW and DOOR SYSTEM

ALUMİNYUM PROFİLLER
ALUMINIUM PROFILES

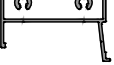
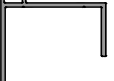

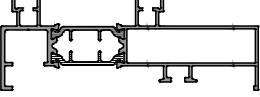
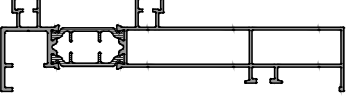
PROFİL ŞEKLİ PROFILE SECTION	PROFİL ADI PROFILE NO	KALIP KODU DIE NO	PROFİL TANIMI PROFILE DESCRIPTION	AĞIRLIK WEIGHT
	P 2549	19901 + 19901	DÜŞEY KANAT PROFİLİ vertical sash profile	1,255kg/mt
	P 2550	19902 + 19902	YATAY KANAT PROFİLİ horizontal sash profile	1,280kg/mt
	P 2551	19903	KENET PROFİLİ interlock profile	0,640kg/mt
	P 2552		KENET PROFİLİ interlock profile	0,940kg/mt
	P 2553	19904	KENET PROFİLİ interlock profile	1,105kg/mt
	P 2554		KENET PROFİLİ interlock profile	1,335kg/mt

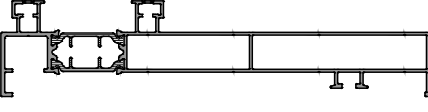
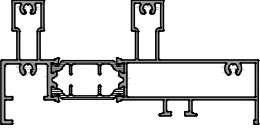
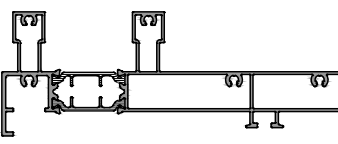
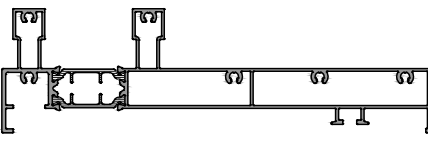
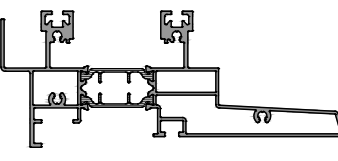
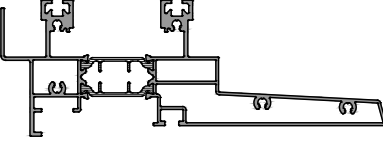
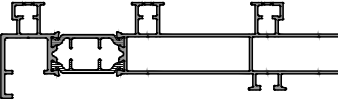
PROFİL ŞEKLİ PROFILE SECTION	PROFİL ADI PROFILE NO	KALIP KODU DIE NO	PROFİL TANIMI PROFILE DESCRIPTION	AĞIRLIK WEIGHT
	P 2555		ÇİFT KANAT ADAPTOR PROFİLİ double sash adepter profile	0,600kg/mt
	P 1020	12769	TİJ PROFİLİ (eloxal) rod profile (anodised)	0,105kg/mt
	P 2556		KASA BESLEME PROFİLİ additional profile for frame	0,180kg/mt
	P 2557		PANJUR KANALI PROFİLİ louver rail profile	0,450kg/mt
	P 2488	19678	ALUMİNYUM RAY PROFİLİ aluminum rail profile	0,170kg/mt
	P 2558		DUVAR İÇİ SÜRME ADAPTÖR PROFİLİ adepter profile for galandage	0,675kg/mt
	P 2559		DUVAR İÇİ SÜRME ADAPTÖR PROFİLİ adepter profile for galandage	0,640kg/mt
	P 2560		DUVAR İÇİ SÜRME ADAPTÖR PROFİLİ adepter profile for galandage	0,535kg/mt
	P 2561	19897 + 19900	100-120 YAN KASA PROFİLİ 100-120 side frame profile	1,740kg/mt
	P 2562		140-160 YAN KASA PROFİLİ 140-160 side frame profile	2.080kg/mt

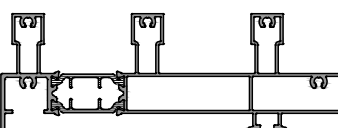
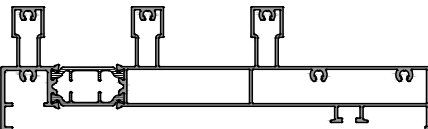
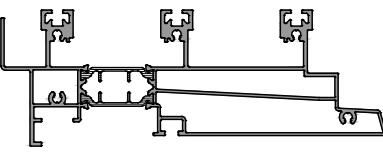
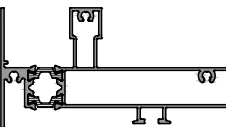
PROFİL ŞEKLİ PROFILE SECTION	PROFİL ADI PROFILE NO	KALIP KODU DIE NO	PROFİL TANIMI PROFILE DESCRIPTION	AĞIRLIK WEIGHT
	P 2563		180-200 YAN KASA PROFİLİ 180-200 side frame profile	2,360kg/mt
	P 2564	19898 + 19899	100-120 ÜST KASA PROFİLİ 100-120 top frame profile	2,160kg/mt
	P 2565		140-160 ÜST KASA PROFİLİ 140-160 top frame profile	2,560kg/mt
	P 2566		180-200 ÜST KASA PROFİLİ 180-200 top frame profile	2,910kg/mt
	P 2567	19905 + 19906	100-120-140 ALT KASA PROFİLİ 100-120-140 bottom frame profile	2,830kg/mt
	P 2568		160-180-200 ALT KASA PROFİLİ 160-180-200 bottom frame profile	3,035kg/mt
	P 2569		140-160 ÜÇ RAYLI YAN KASA PROFİLİ 140-160 triple rail side frame profile	2,235kg/mt

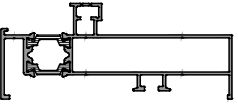
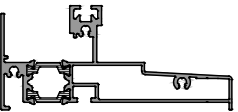
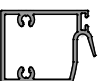
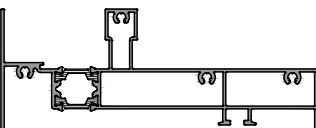
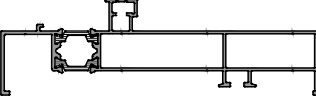
PROFİL ŞEKLİ PROFILE SECTION	PROFİL ADI PROFILE NO	KALIP KODU DIE NO	PROFİL TANIMI PROFILE DESCRIPTION	AĞIRLIK WEIGHT
	P 2570		180-200 ÜÇ RAYLI YAN KASA PROFİLİ 180-200 triple rail side frame profile	2,515kg/mt
	P 2571		140-160 ÜÇ RAYLI ÜST KASA PROFİLİ 140-160 triple rail top frame profile	2,810kg/mt
	P 2572		180-200 ÜÇ RAYLI ÜST KASA PROFİLİ 180-200 triple rail top frame profile	3,155kg/mt
	P 2573		140-160-180-200 ÜÇ RAYLI ÜST KASA PROFİLİ 140-160-180-200 triple rail top frame profile	3,615kg/mt
	P 2574		160 DUVAR İÇİ SÜRME TEK RAYLI ÜST KASA PROFİLİ single rail top frame profile for 160 galandage	1,910kg/mt

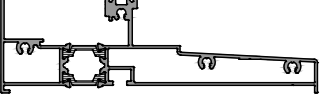

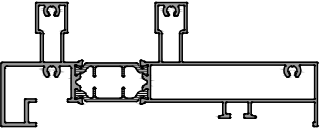
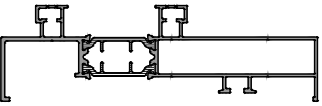
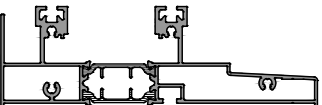



PROFİL ŞEKLİ PROFILE SECTION	PROFİL ADI PROFILE NO	KALIP KODU DIE NO	PROFİL TANIMI PROFILE DESCRIPTION	AĞIRLIK WEIGHT
	P 2575		160 DUVAR İÇİ SÜRME TEK RAYLI YAN KASA PROFİLİ single rail side frame profile for 160 galandage	1,510kg/mt
	P 2576		160 DUVAR İÇİ SÜRME TEK RAYLI ALT KASA PROFİLİ single rail bottom frame profile for 160 galandage	1,855kg/mt
	P 2577		160-200 DUVAR İÇİ SÜRME DIŞ KENET PROFİLİ external interlock profile for 160-200 galandage	0,860kg/mt
	P 2578		200 DUVAR İÇİ SÜRME TEK RAYLI ÜST KASA PROFİLİ single rail top frame profile for 200 galandage	2,275kg/mt
	P 2579		200 DUVAR İÇİ SÜRME TEK RAYLI YAN KASA PROFİLİ single rail side frame profile for 200 galandage	1,810kg/mt

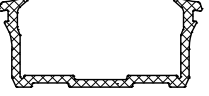
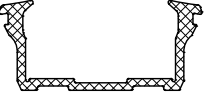
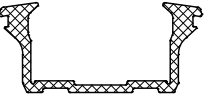

PROFİL ŞEKLİ PROFILE SECTION	PROFİL ADI PROFILE NO	KALIP KODU DIE NO	PROFİL TANIMI PROFILE DESCRIPTION	AĞIRLIK WEIGHT
	P 2580		200 DUVAR İÇİ SÜRME TEK RAYLI ALT KASA PROFİLİ single rail bottom frame profile for 200 galandage	2,195kg/mt
	P 2581		200 DUVAR İÇİ SÜRME DIŞ KENET PROFİLİ external interlock profile for 200 galandage	1,090kg/mt
	P 2582		200 DUVAR İÇİ SÜRME ÇİFT RAYLI ÜST KASA PROFİLİ double rail top frame profile for 200 galandage	2,440kg/mt
	P 2583		200 DUVAR İÇİ SÜRME ÇİFT RAYLI YAN KASA PROFİLİ double rail side frame profile for 200 galandage	1,885kg/mt
	P 2584		200 DUVAR İÇİ SÜRME ÇİFT RAYLI ALT KASA PROFİLİ double rail bottom frame profile for 200 galandage	2,490kg/mt

PROFİL ŞEKLİ PROFILE SECTION	PROFİL ADI PROFILE NO	KALIP KODU DIE NO	PROFİL TANIMI PROFILE DESCRIPTION	AĞIRLIK WEIGHT
	P 2585		YENİLEME KASA PROFİLİ renovation frame profile	2,205kg/mt
	P 2586		YENİLEME KASA PROFİLİ renovation frame profile	2,390kg/mt
	P 2587		YENİLEME KASA PROFİLİ renovation frame profile	2,150kg/mt
	P 2588		YENİLEME KASA KAPAK PROFİLİ renovation cap profile for frame	0,300kg/mt
	P 2589		KLASİK MONTAJLI KASA classique pose tunnel frame profile	1,650kg/mt
	P 2590		PANJURLU UYGULAMA ÜST KASA PROFİLİ louvered application top frame profile	2,000kg/mt
	P 2591		PANJUR KANALI PROFİLİ louver rail profile	0,645kg/mt

MOTIONslide
SÜRME KAPI ve PENCERE SİSTEMİ
SLIDING WINDOW and DOOR SYSTEM



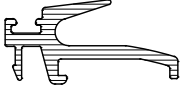



CONTALAR
GASKETS

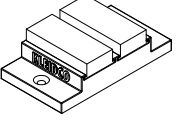

CONTA ŞEKLİ GASKET SECTION	CONTA KODU GASKET NO	MALZEME MATERIAL	CONTA TANIMI GASKET DESCRIPTION	PAKET PACKAGE
	800 259	polipropylene	PERDELİ FIRÇA FİTİL brush gasket with fin	275mt/pk
	800 596	EPDM	KENET CONTASI interlock gasket	428mt/pk 0,035kg/mt
	800 598	polipropylene	PERDELİ FIRÇA FİTİL brush gasket with fin	275mt/pk
	800 665	EPDM	U CAM CONTASI U shape glazing gasket	105mt/pk 0,142kg/mt
	800 666	EPDM	U CAM CONTASI U shape glazing gasket	95mt/pk 0,157kg/mt
	800 667	EPDM	U CAM CONTASI U shape glazing gasket	90mt/pk 0,167kg/mt
	800 668	EPDM	U CAM CONTASI U shape glazing gasket	85mt/pk 0,177kg/mt
	800 669	TPE	KANAT CONTASI sash gasket	285mt/pk 0,052kg/mt
	600 416	PVC	U KANAL PROFİLİ U channel profile	6mt 25ad/pk. 0,144kg/mt
	600 429	polyamide	TİJ PROFİLİ rod profile	6mt 25ad/pk. 0,070kg/mt

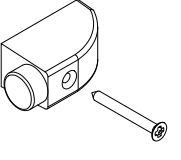
CONTA ŐEKLİ GASKET SECTION	CONTA KODU GASKET NO	MALZEME MATERIAL	CONTA TANIMI GASKET DESCRIPTION	PAKET PACKAGE
	600 468	polyamide	KENET PROFİLİ interlock profile	6mt 25ad/pk. 0,188kg/mt
	600 507	PVC	L KANAL PROFİLİ L channel profile	6mt 25ad/pk. 0,080kg/mt

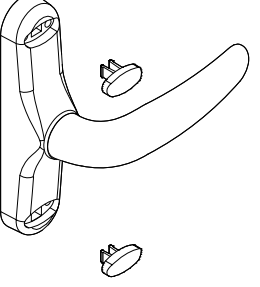
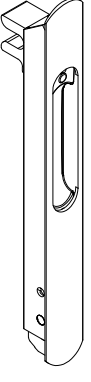

MOTIONslide
SÜRME KAPI ve PENCERE SİSTEMİ
SLIDING WINDOW and DOOR SYSTEM

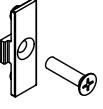
AKSESUARLAR
ACCESSORIES

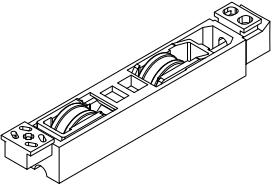
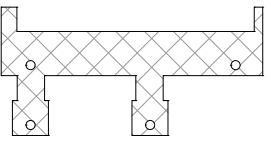
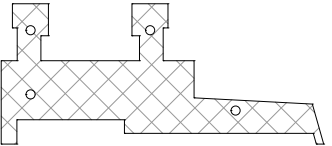
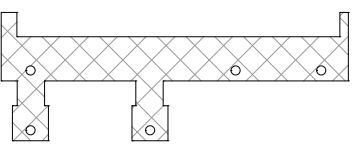

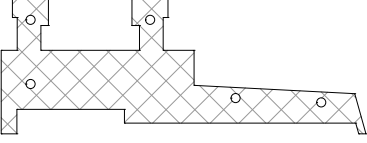
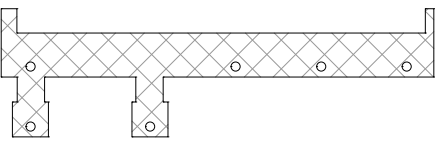
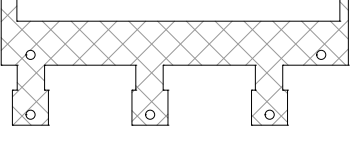
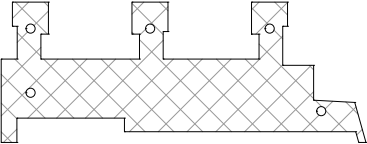
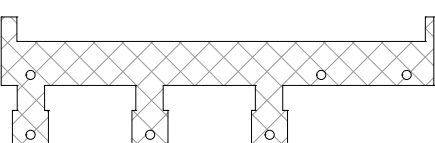
AKSESUAR ŞEKLİ ACCESSORIES SHAPE	AKSESUAR ACCESS. NO	AKSESUAR TANIMI ACCESSORIES DESCRIPTION	MİKTAR QUANTITY
	700 449	ALT ve ÜST SIZDIRMAZLIK tightness plug for top and bottom	20 adet/pieces
	700 451	SU TAHLİYE KAPAGI weep hole cap	50 adet/pieces
	700 473	STOPER bumper	20 adet/pieces
	700 628	KANAT DURDURUCU bumper for sash	50 adet/pieces
	701 244	KAPAKLI EKSENEL KOL axial handle with cover	20 adet/pieces
	700 869	EL İLE KUMANDALI KOL (Standart renk : siyah) (Tüm Ral Renkleri - min.miktar :1000ad) manuel control handle (standart color : black) (for all Ral color - min.quantity :1000pcs.)	20 adet/pieces
∩	701 193	PASLANMAZ ÇELİK RAY stainless steel rail	30mt (3mt X 10pcs)
	701 200	KİLİT KANCASI locking device	25 adet/pieces

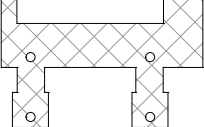
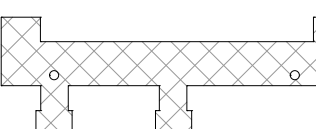

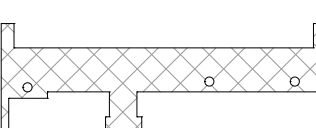
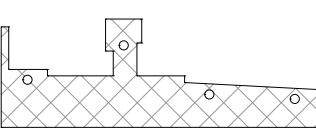
AKSESUAR ŞEKLİ ACCESSORIES SHAPE	AKSESUAR ACCESS. NO	AKSESUAR TANIMI ACCESSORIES DESCRIPTION	MİKTAR QUANTITY
	701 201	KİLİT BAGLANTISI locking link device	25 adet/pieces
	701 219	KİLİT KARŞILIGI keeper	25 adet/pieces
	701 220	AYARLI RULMAN adjustable roller	20 adet/pieces
	701 221	100-120 ÜST KASA YALITIM BANTI 100-120 top frame insulation tape	50 adet/pieces
	701 222	100-120-140 ALT KASA YALITIM BANTI 100-120-140 bottom frame insulation tape	50 adet/pieces
	701 223	140-160 ÜST KASA YALITIM BANTI 140-160 top frame insulation tape	50 adet/pieces

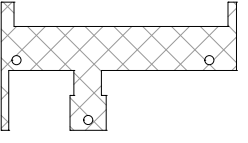
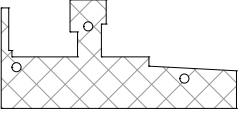
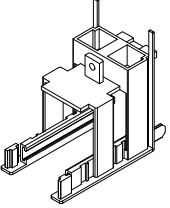
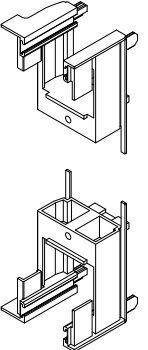
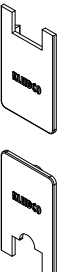
AKSESUAR ŞEKLİ ACCESSORIES SHAPE	AKSESUAR ACCESS. NO	AKSESUAR TANIMI ACCESSORIES DESCRIPTION	MİKTAR QUANTITY
	701 224	160-180-200 ALT KASA YALITIM BANTI 160-180-200 bottom frame insulation tape	50 adet/pieces
	701 225	180-200 ÜST KASA YALITIM BANTI 180-200 top frame insulation tape	50 adet/pieces
	701 226	140-160 ÜÇ RAYLI ÜST KASA YALITIM BANTI 140-160 top triple rail frame insulation tape	50 adet/pieces
	701 227	140-160-180-200 ÜÇ RAYLI ALT KASA YALITIM BANTI 140-160-180-200 bottom triple rail frame insulation tape	50 adet/pieces
	701 228	180-200 ÜÇ RAYLI ÜST KASA YALITIM BANTI 180-200 top triple rail frame insulation tape	50 adet/pieces

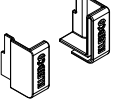
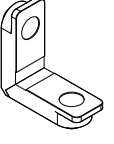
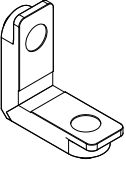
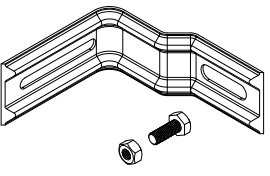
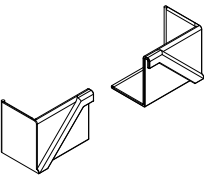
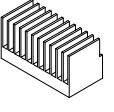
AKSESUAR ŐEKLİ ACCESSORIES SHAPE	AKSESUAR ACCESS. NO	AKSESUAR TANIMI ACCESSORIES DESCRIPTION	MİKTAR QUANTITY
	701 229	PANJURLU ÜST KASA YALITIM BANTI louver application top frame insulation tape	50 adet/pieces
	701 230	200 DUVAR İÇİ SÜRME ÇİFT RAYLI ÜST KASA YALITIM BANTI double rail top frame insulation tape for 200 galandage	50 adet/pieces
	701 231	200 DUVAR İÇİ SÜRME ÇİFT RAYLI ALT KASA YALITIM BANTI double rail bottom frame insulation tape for 200 galandage	50 adet/pieces
	701 232	200 DUVAR İÇİ SÜRME TEK RAYLI ÜST KASA YALITIM BANTI single rail top frame insulation tape for 200 galandage	50 adet/pieces
	701 233	200 DUVAR İÇİ SÜRME TEK RAYLI ALT KASA YALITIM BANTI single rail bottom frame insulation tape for 200 galandage	50 adet/pieces

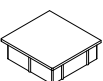
AKSESUAR ŞEKLİ ACCESSORIES SHAPE	AKSESUAR ACCESS. NO	AKSESUAR TANIMI ACCESSORIES DESCRIPTION	MİKTAR QUANTITY
	701 234	160 DUVAR İÇİ SÜRME TEK RAYLI ÜST KASA YALITIM BANTI single rail top frame insulation tape for 160 galandage	50 adet/pieces
	701 235	160 DUVAR İÇİ SÜRME TEK RAYLI ALT KASA YALITIM BANTI single rail bottom frame insulation tape for 160 galandage	50 adet/pieces
	701 236	YATAY-DÜŞEY KANAT BİRLEŞTİRME TAKOZU vertical-horizontal sash corner joint block	20 adet/pieces
	701 237	YATAY-DÜŞEY KANAT BİRLEŞTİRME TAKOZU vertical-horizontal sash corner joint block	10 çift/pair
	701 238	KENET KAPAGI interlock cap plug	10 çift/pair

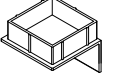
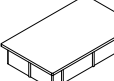
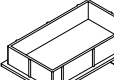
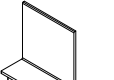
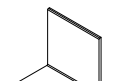
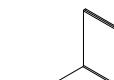
AKSESUAR ŞEKLİ ACCESSORIES SHAPE	AKSESUAR ACCESS. NO	AKSESUAR TANIMI ACCESSORIES DESCRIPTION	MİKTAR QUANTITY
	701 239	DRENAJ KAPAGI drain cap plug	10 çift/pair
	700 974	BUTONLU KÖŞE TAKOZU button corner for flyscreen	50 adet/pieces
	701 240	BUTONLU KÖŞE TAKOZU button corner for flyscreen	50 adet/pieces
	701 241	MONTAJ ANKRAJI installing bracket	20 adet/pieces
	701 242	DRENAJ KAPAGI drain cap plug	10 çift/pair
	701 243	DUVAR İÇİ GİZLİ SÜRME DIŞ ALAN SIZDIRMAZLIK PARÇASI tightness plug for galandage external area	20 adet/pieces
	701 245	KENET ÜST KAPAK interlock top cover	20 adet/pieces
	701 246	KENET ALT KAPAK interlock bottom cover	20 adet/pieces
	701 247	KENET ÜST KAPAK interlock top cover	20 adet/pieces

AKSESUAR ŞEKLİ ACCESSORIES SHAPE	AKSESUAR ACCESS. NO	AKSESUAR TANIMI ACCESSORIES DESCRIPTION	MİKTAR QUANTITY
 <p>701 248 alt kenet kapagi bottom interlock cap</p>	701 248	KENET ALT KAPAK interlock bottom cover	20 adet/pieces
 <p>701 249 üst kenet kapagi top interlock cap</p>	701 249	KENET ÜST KAPAK interlock top cover	20 adet/pieces
 <p>701 250 alt kenet kapagi bottom interlock cap</p>	701 250	KENET ALT KAPAK interlock bottom cover	20 adet/pieces
 <p>701 251 üst kenet kapagi top interlock cap</p>	701 251	KENET ÜST KAPAK interlock top cover	20 adet/pieces
 <p>701 252 üst kenet kapagi top interlock cap</p>	701 252	KENET ÜST KAPAK interlock top cover	20 adet/pieces
 <p>701 253 üst kenet kapagi top interlock cap</p>	701 253	KENET ÜST KAPAK interlock top cover	20 adet/pieces
	701 254	15aks GEARBOX 15axe gearbox	20 adet/pieces

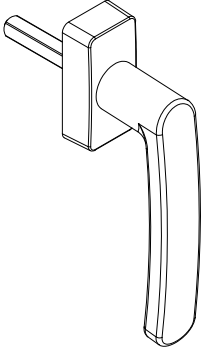
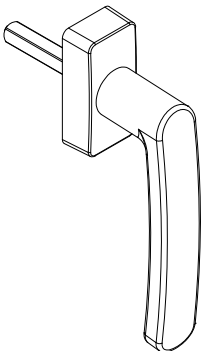
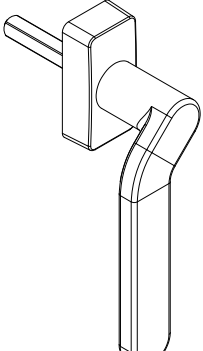
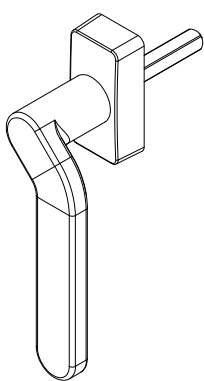
AKSESUAR ŞEKLİ ACCESSORIES SHAPE	AKSESUAR ACCESS. NO	AKSESUAR TANIMI ACCESSORIES DESCRIPTION
	700 830	140mm DÜZ KOL (90° stoplu) (Standart renk : siyah) (Tüm Ral renkleri - min:1000ad) 140mm FLAT HANDLE (90° limited) (Standart color : black) (All Ral colours - min:1000pieces)
	700 831	140mm DÜZ KOL (Standart renk : siyah) (Tüm Ral renkleri - min:1000ad) 140mm FLAT HANDLE (Standart color : black) (All Ral colours - min:1000pieces)
	700 832	140mm SOLA KIVRIK KOL (Standart renk : siyah) (Tüm Ral renkleri - min:1000ad) 140mm LEFT CURVED HANDLE (Standart color : black) (All Ral colours - min:1000pieces)
	700 833	140mm SAGA KIVRIK KOL (Standart renk : siyah) (Tüm Ral renkleri - min:1000ad) 140mm RIGHT CURVED HANDLE (Standart color : black) (All Ral colours - min:1000pieces)

MOTIONslide
SÜRME KAPI ve PENCERE SİSTEMİ
SLIDING WINDOW and DOOR SYSTEM

UYGULANABİLİR AÇILIM TİPLERİ
APPLICABLE OPENING TIPOLOGIES

TİP 01 :
Type 01 :
çift raylı kasa,çift kanat kayar
double tracks,double sash slide

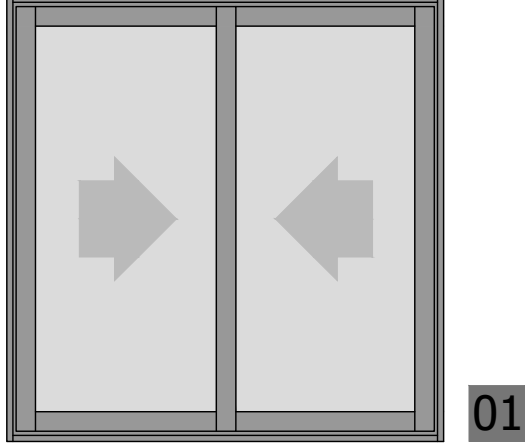

dış görünüş
external view

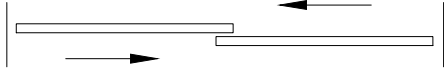

TİP 02 :
Type 02 :
çift raylı kasa,dört kanat kayar
double tracks,four sash slide

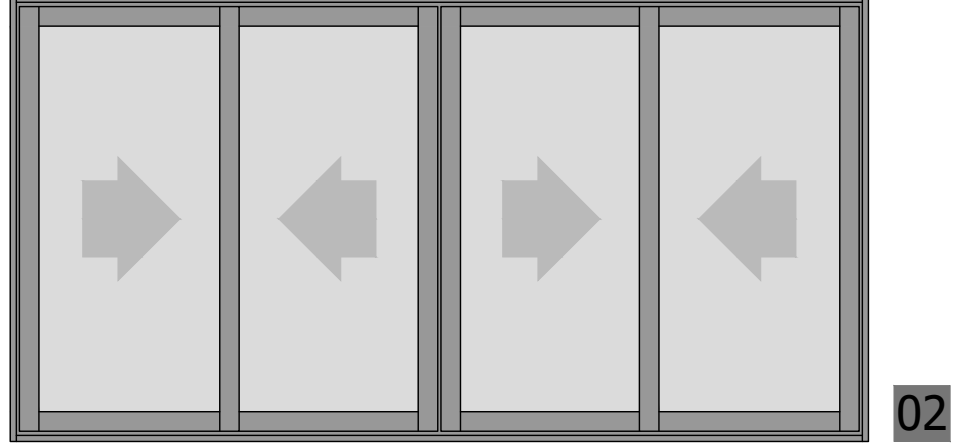

dış görünüş
external view



TİP 03 :
Type 03 :
üç raylı kasa,altı kanat kayar,
triple tracks,six sash slide,

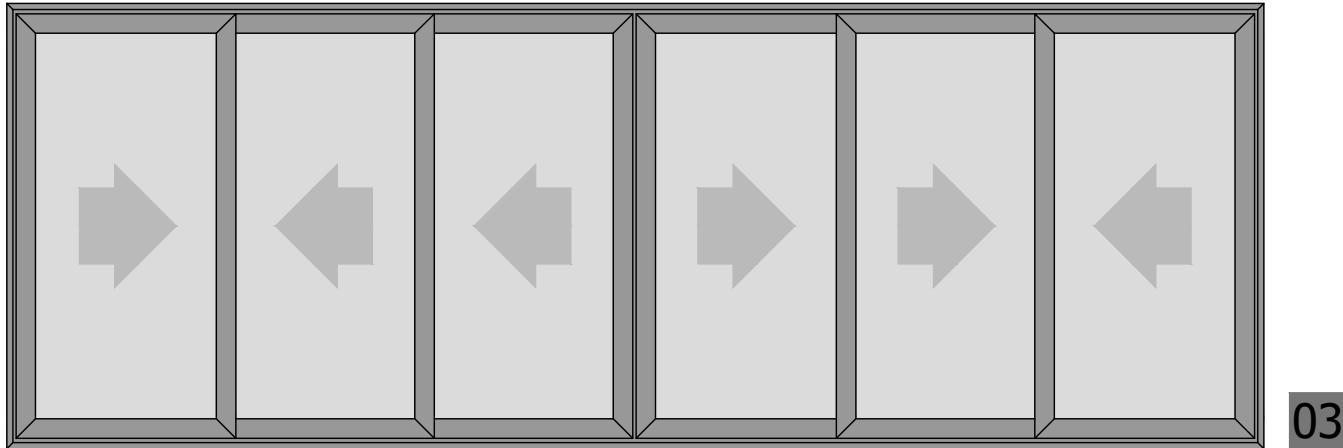

dış görünüş
external view



TİP 04 :
Type 04 :
üç raylı kasa,üç kanat kayar
triple tracks,triple sash slide

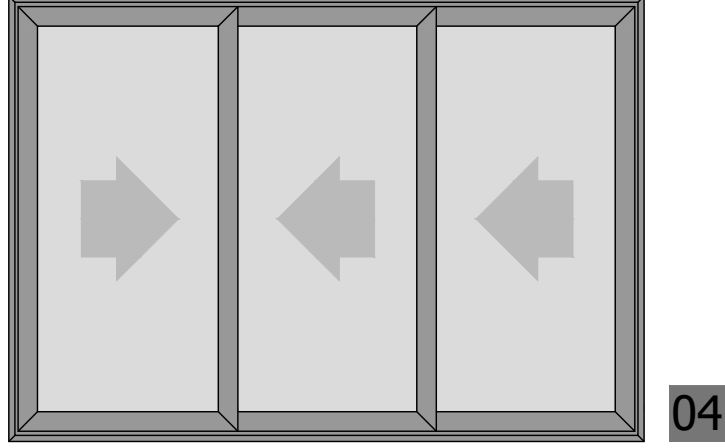

dış görünüş
external view

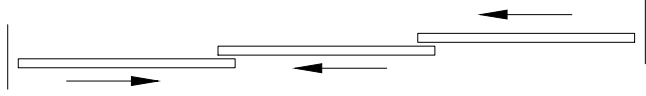

TİP 05 :
Type 05 :
çift raylı kasa,çift kanat kayar duvar içinde gizli
double tracks,double sash sliding concealed in wall

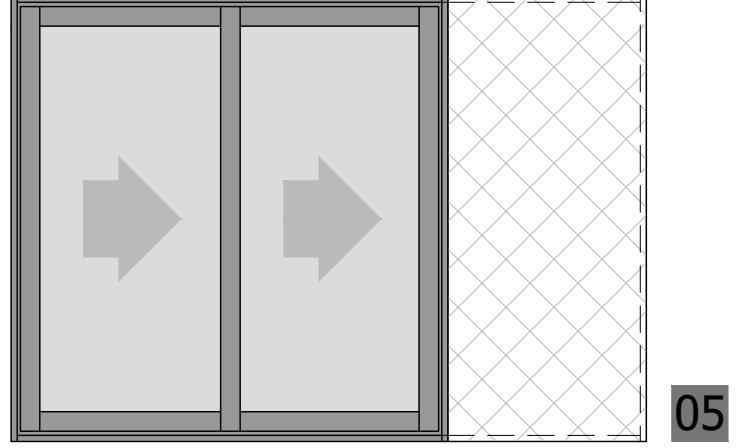

dış görünüş
external view

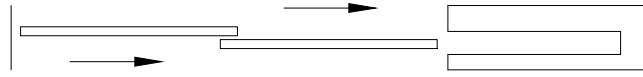

TİP 06 :
Type 06 :
çift raylı kasa,dört kanat kayar duvar içinde gizli
double tracks,four sash sliding concealed in wall

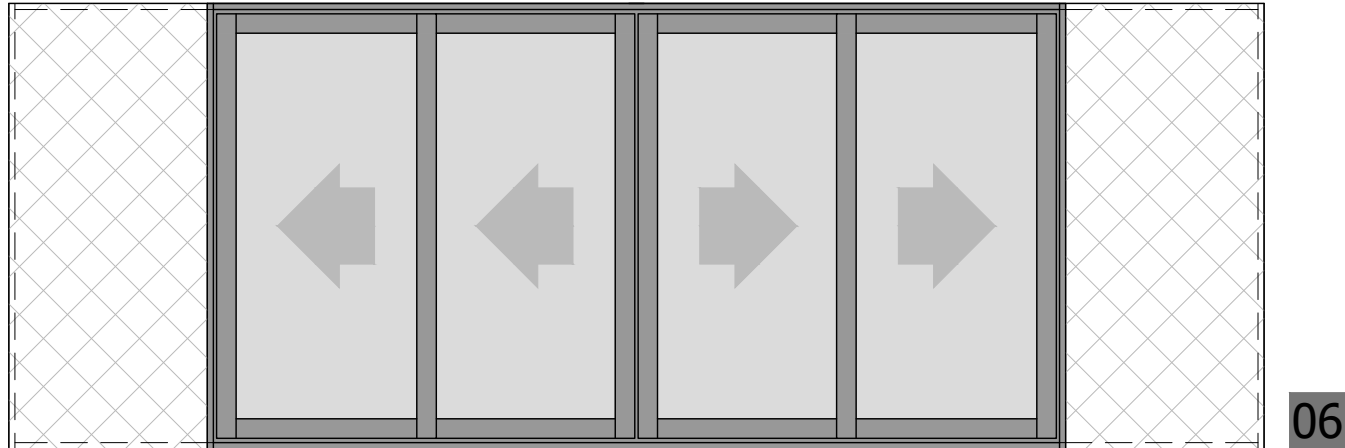

dış görünüş
external view



TİP 07 :
Type 07 :
tek raylı kasa,tek kanat kayar duvar içinde gizli
single tracks, single sash sliding concealed in wall

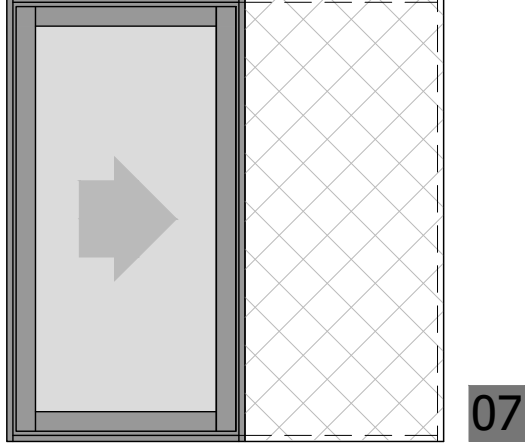

dış görünüş
external view

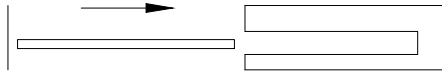

TİP 08 :
Type 08 :
çift raylı kasa,dört kanat kayar duvar içinde gizli
double tracks, four sash sliding concealed in wall

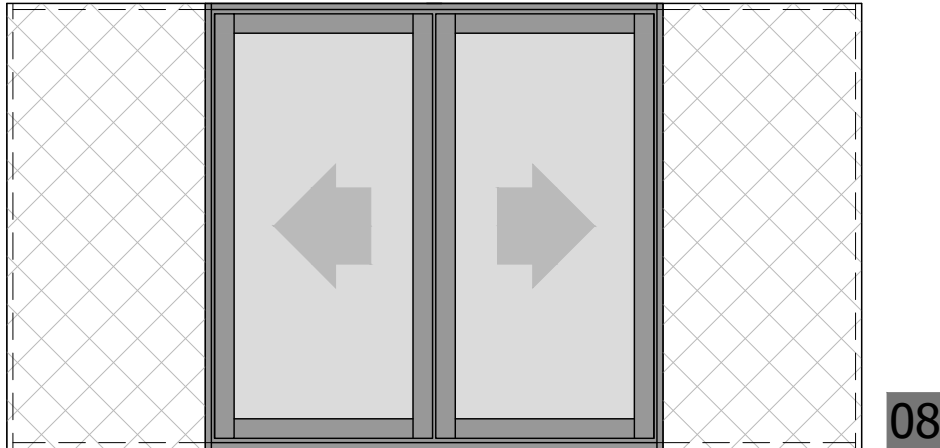

dış görünüş
external view



MOTIONslide
SÜRME KAPI ve PENCERE SİSTEMİ
SLIDING WINDOW and DOOR SYSTEM

TAM ÖLÇEKLİ PROFİLLER
FULL SCALE PROFILES

P 2551
Yan Kasa Profili
Side Frame Profile
0,640kg/mt

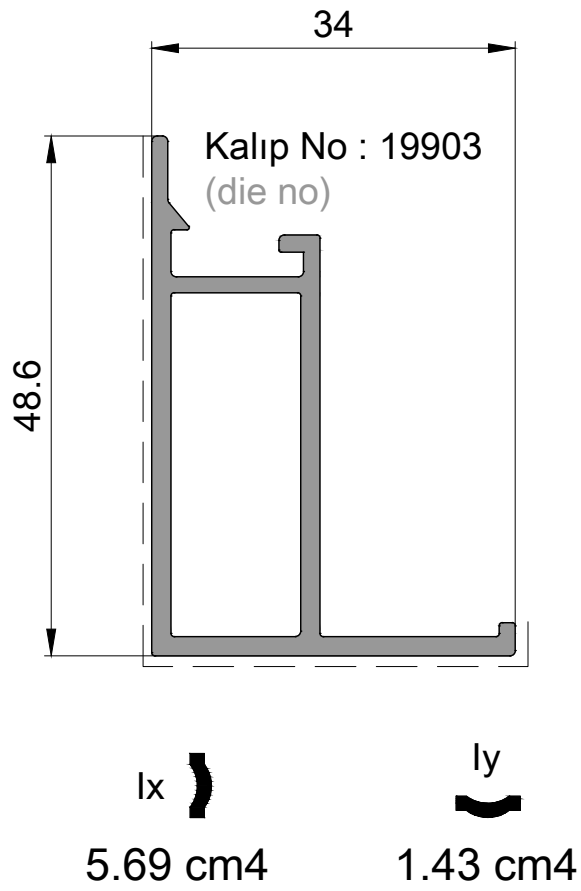

P 2552
Yan Kasa Profili
Side Frame Profile
0,940kg/mt

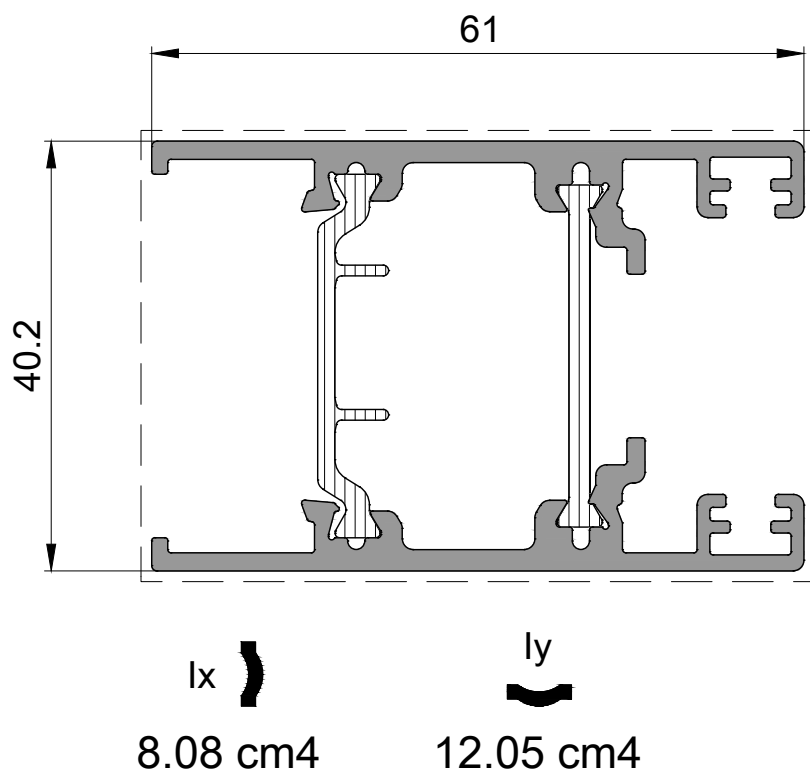
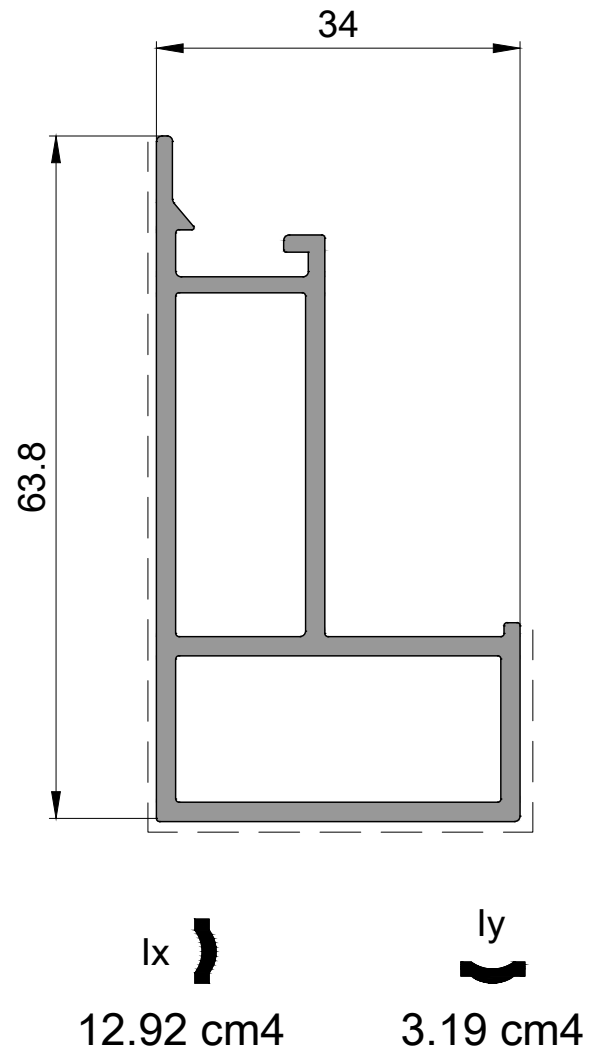

Kalip No : 19901
(die no)

P 2549
Yan Kasa Profili
Side Frame Profile
1,255kg/mt

P 2553
Yan Kasa Profili
Side Frame Profile
1,105kg/mt

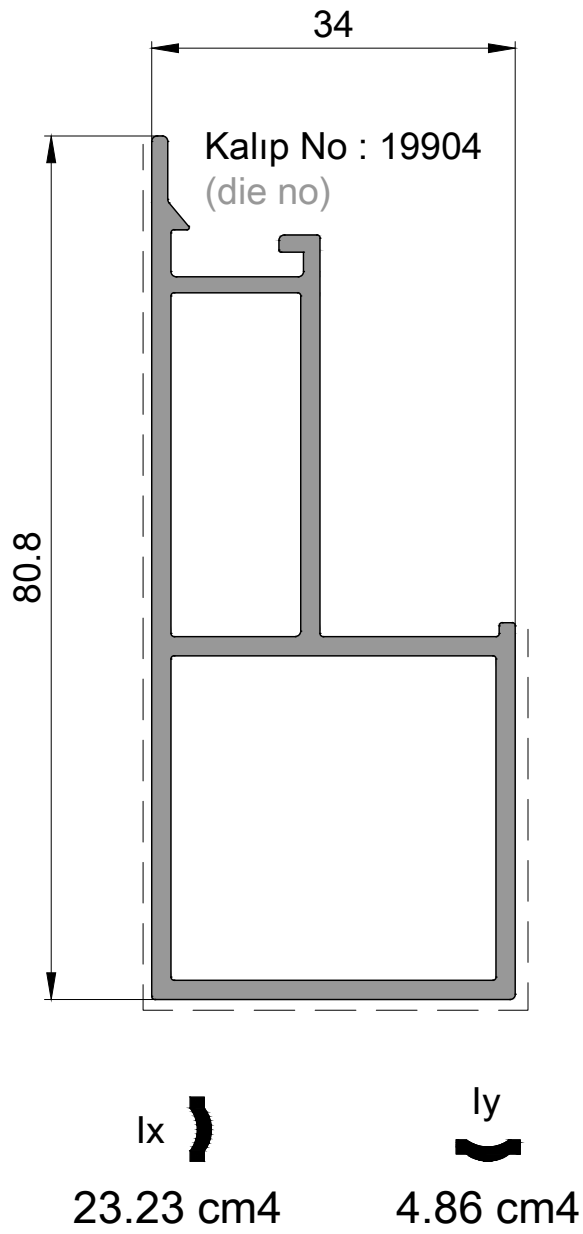

P 2554
Yan Kasa Profili
Side Frame Profile
1,335kg/mt

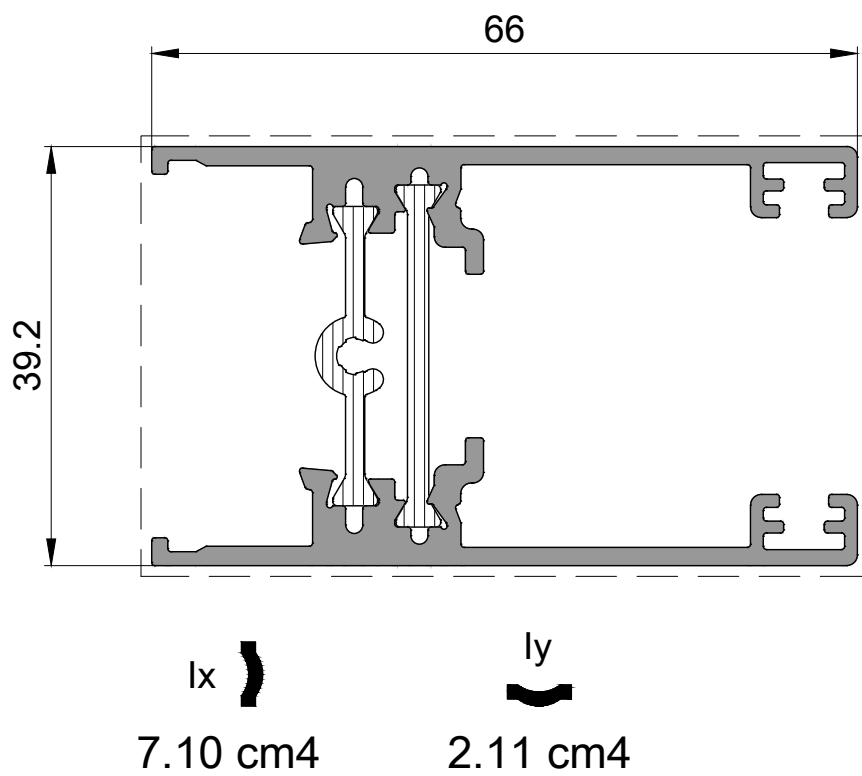
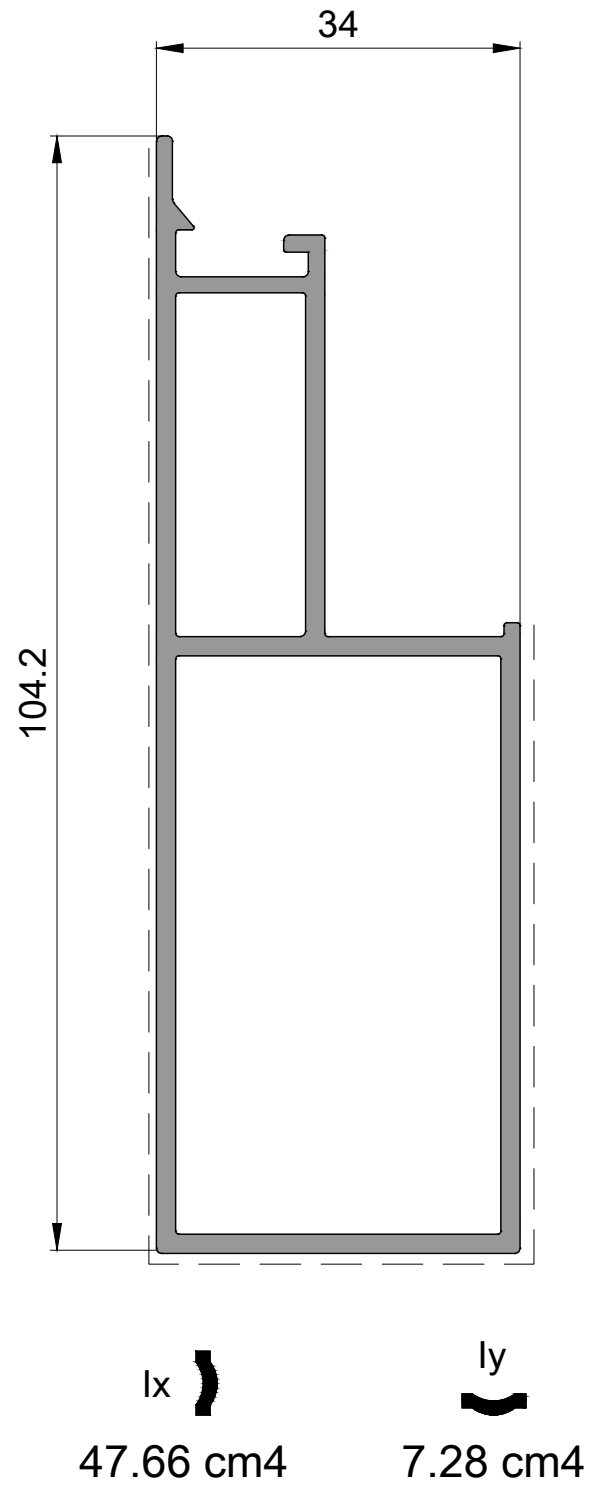

P 2550
Yan Kasa Profili
Side Frame Profile
1,280kg/mt

P 2555
Adaptör Profili
Adepter Profile
0,600kg/mt

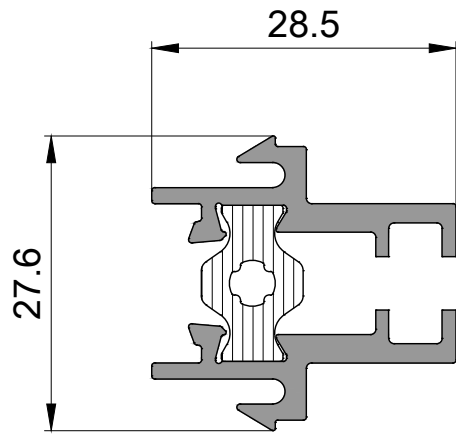

P 2556
Kapak Profili
Cap Profile
0,180kg/mt

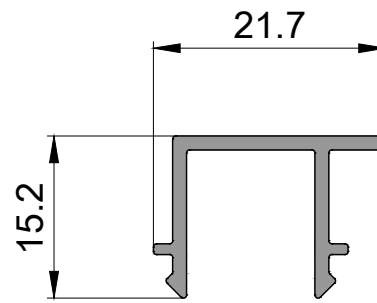

P 2558
Kapatma Profili
Closing Profile
0,675kg/mt

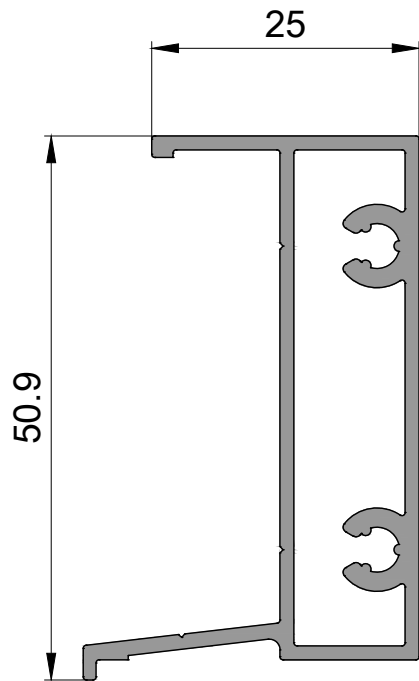

P 2559
Kapatma Profili
Closing Profile
0,640kg/mt

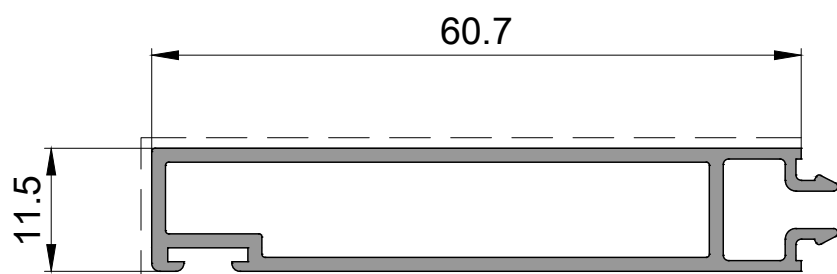
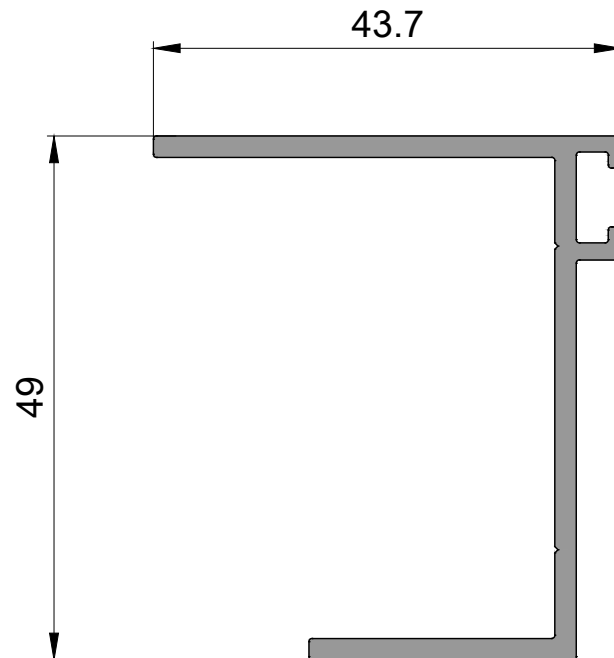

P 2560
Kapatma Profili
Closing Profile
0,535kg/mt

P 2561
Yan Kasa Profili
Side Frame Profile
1,740kg/mt

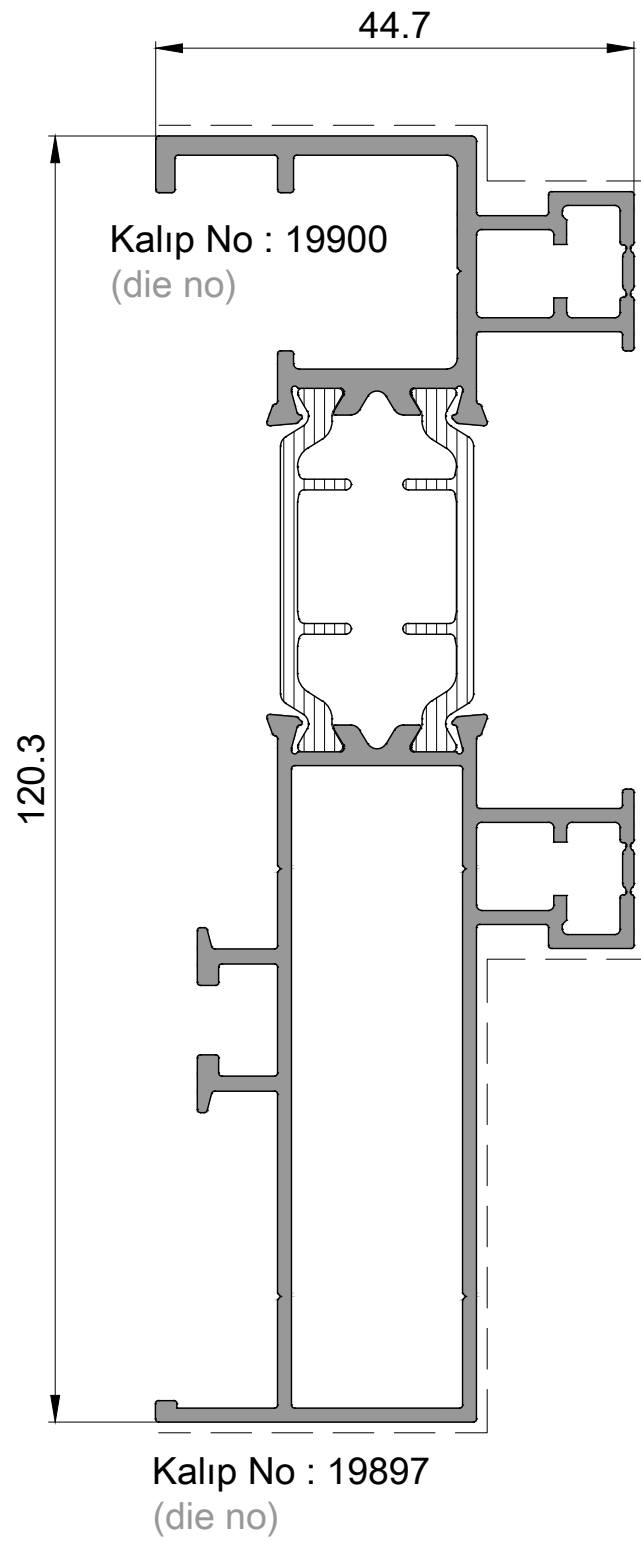

P 2562
Yan Kasa Profili
Side Frame Profile
2,080kg/mt

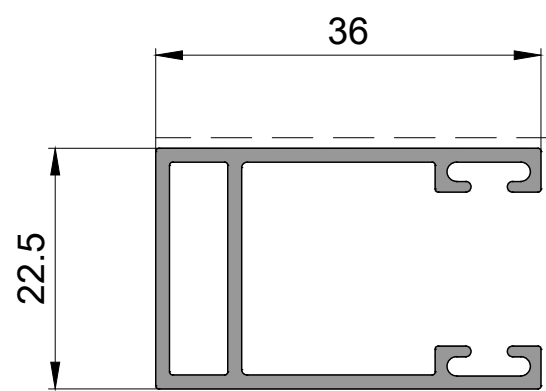
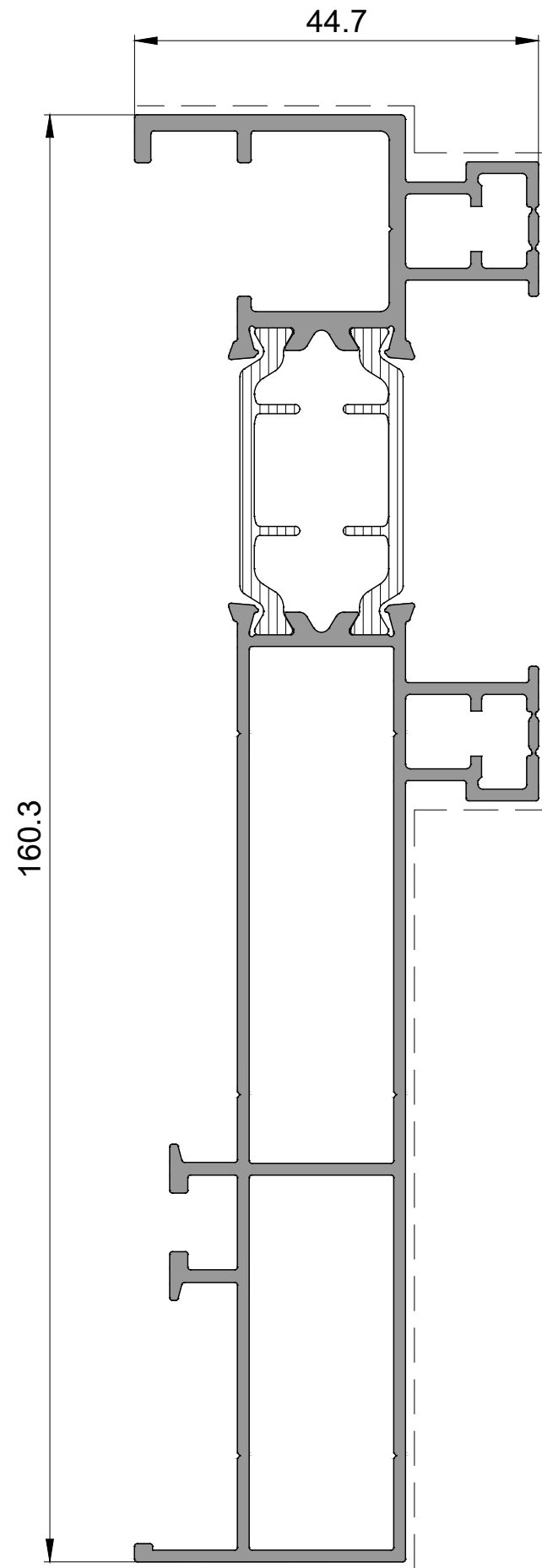

P 2557
Panjur Kanal Profili
Roller Rail Profile
0,450kg/mt

P 2563
Yan Kasa Profili
Side Frame Profile
2,360kg/mt

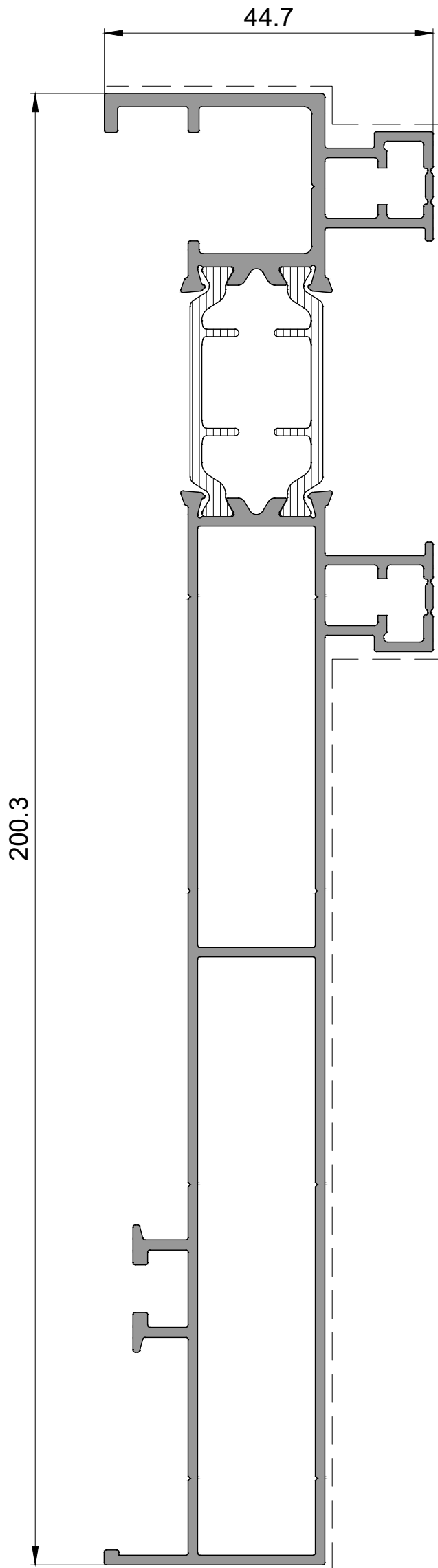

P 2564
Üst Kasa Profili
Top Frame Profile
2,160kg/mt

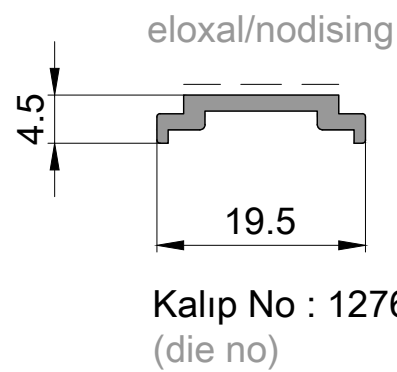
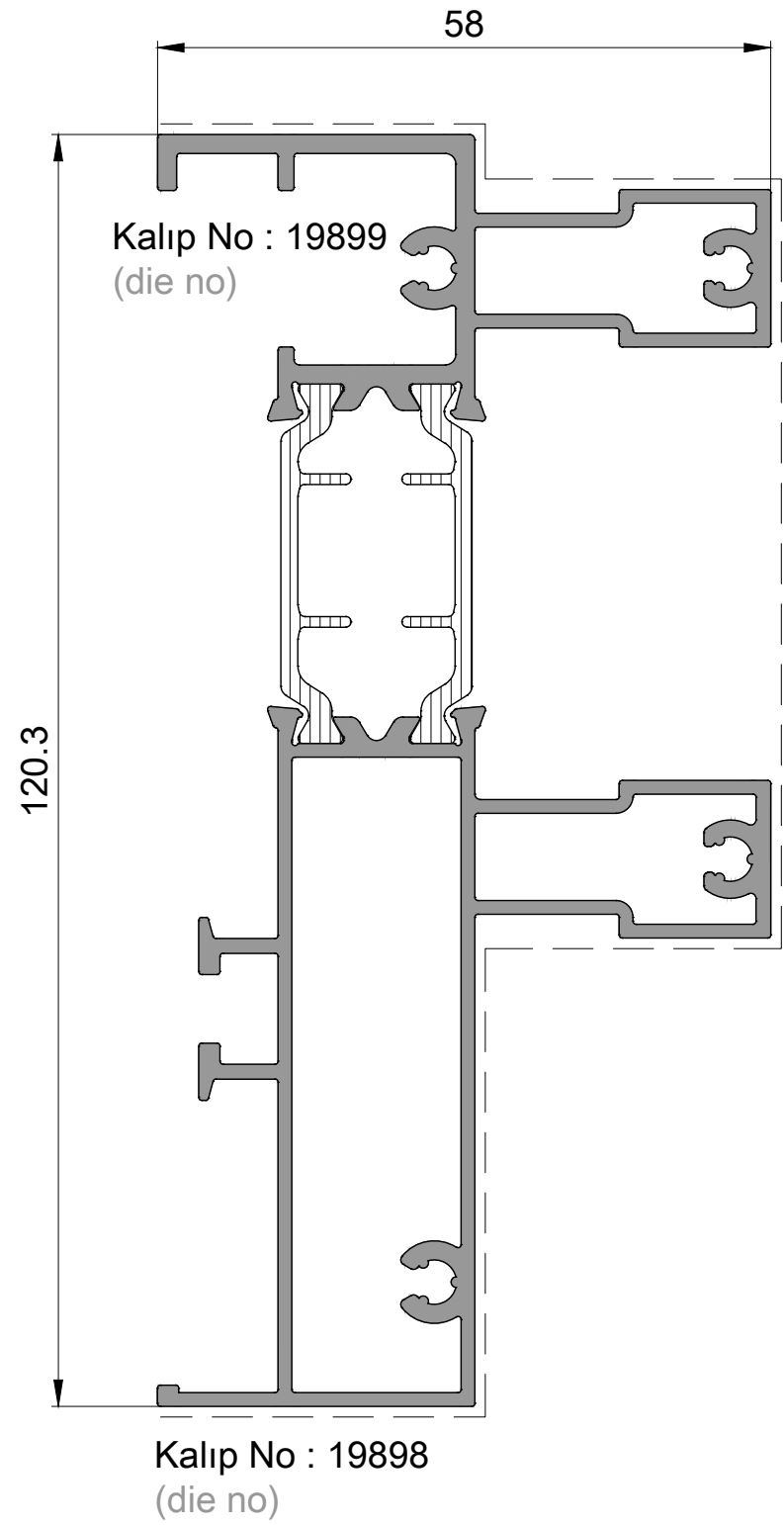

P 1020
Tij Profili / Rod Profile
0,105kg/mt

P 2565
Üst Kasa Profili
Top Frame Profile
2,560kg/mt

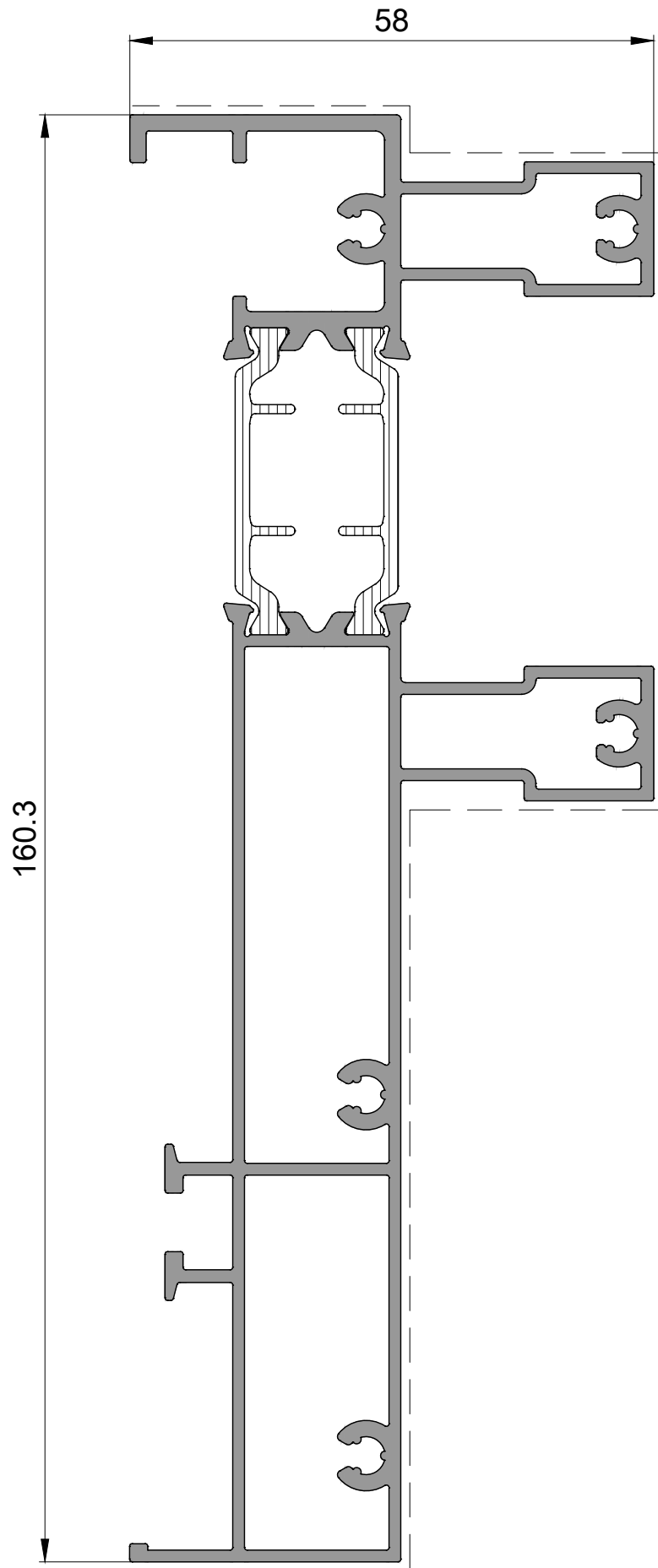

P 2566
Üst Kasa Profili
Top Frame Profile
2,910kg/mt

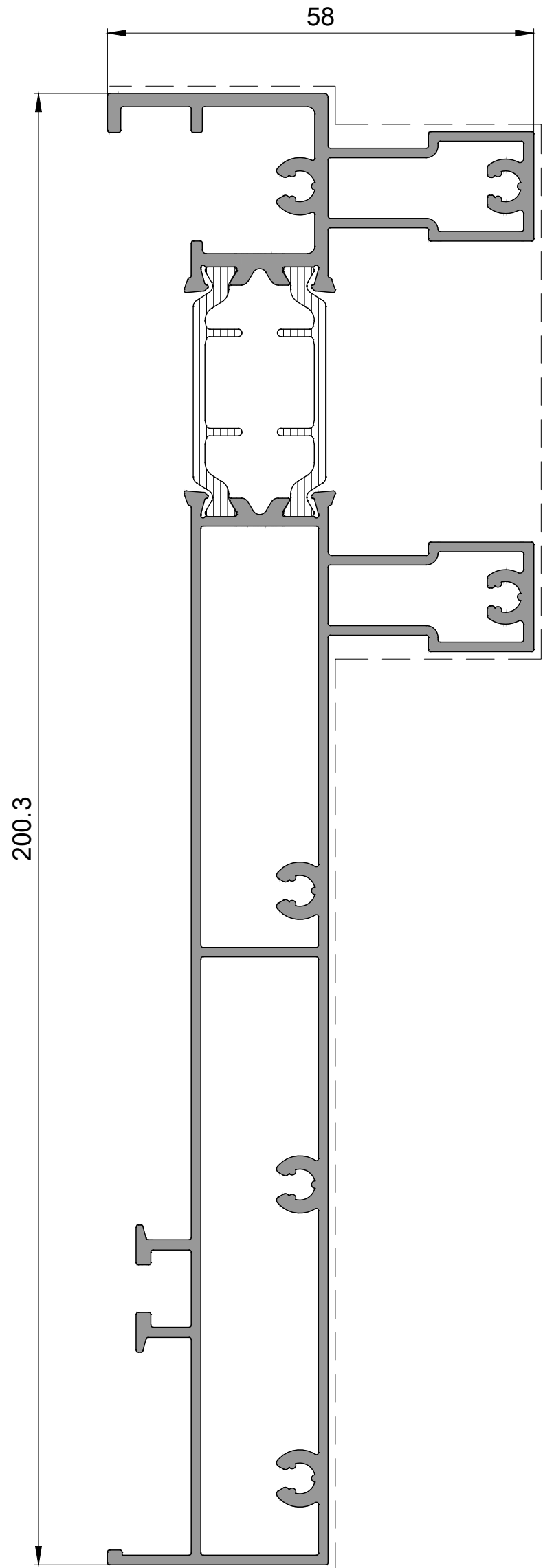

P 2567
Alt Kasa Profili
Bottom Frame Profile
2,830kg/mt

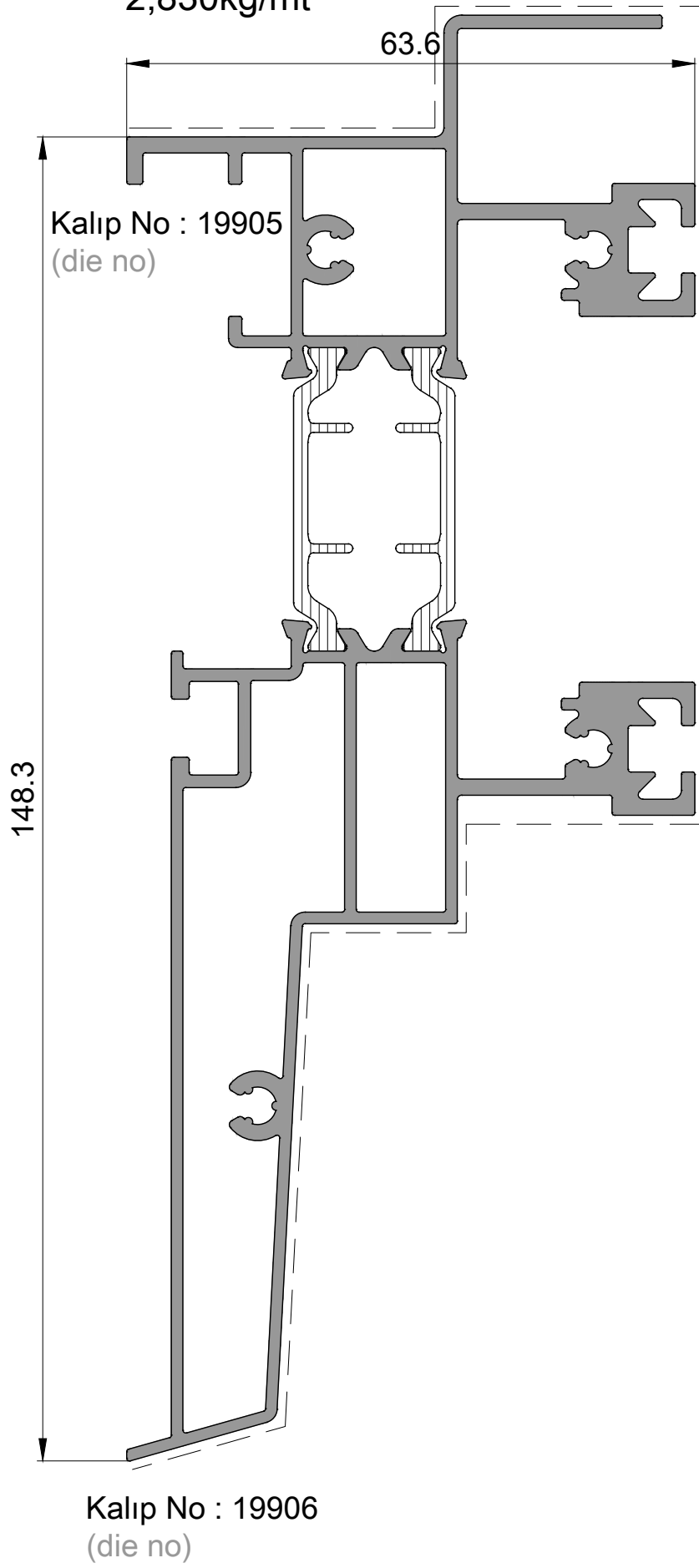

P 2568
Alt Kasa Profili
Bottom Frame Profile
3,035kg/mt

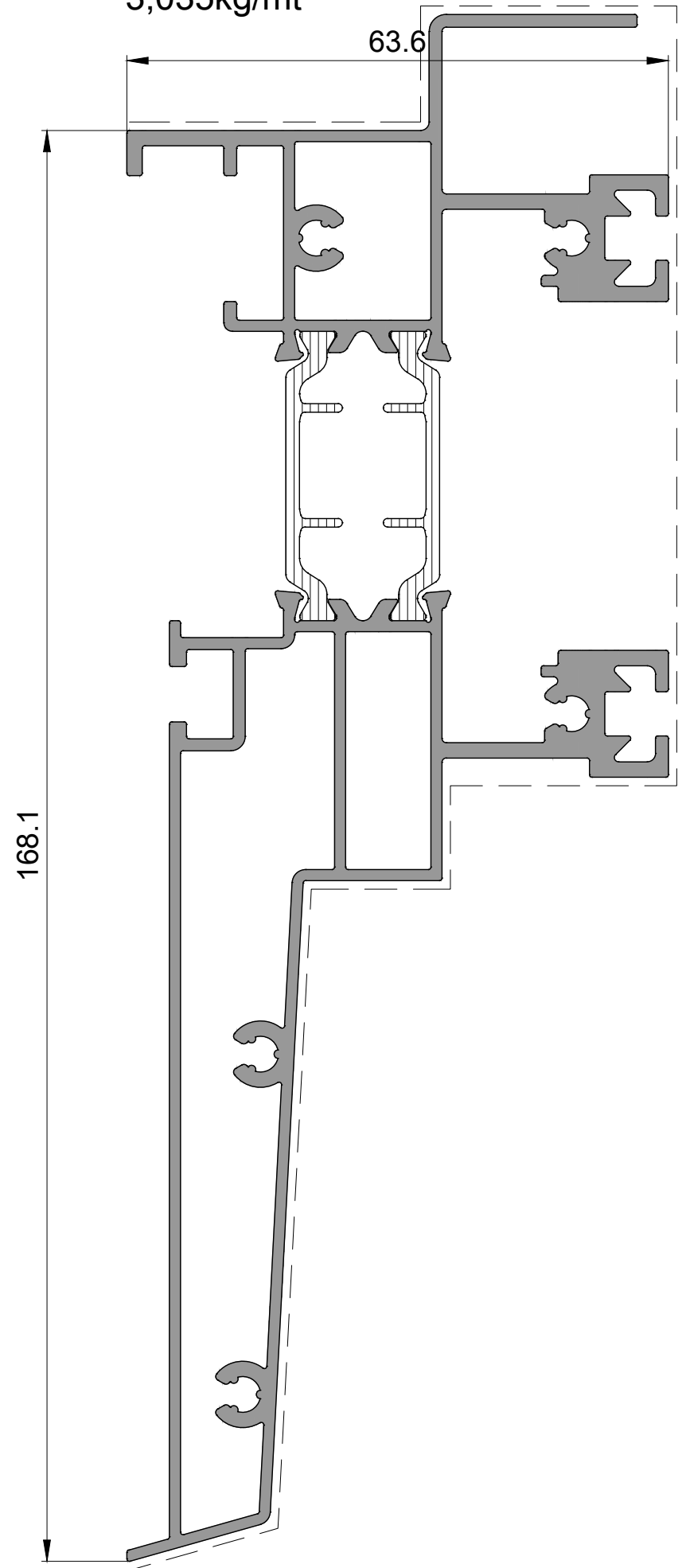

P 2569
Yan Kasa Profili
Side Frame Profile
2,235kg/mt

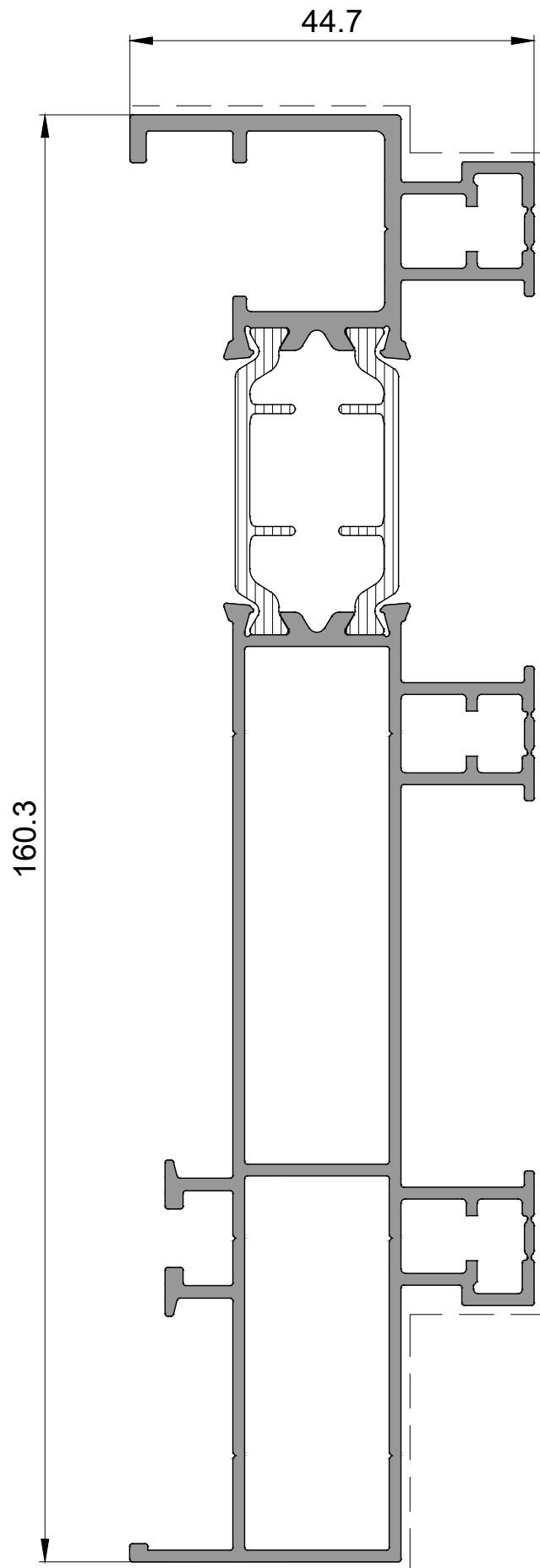

P 2570
Yan Kasa Profili
Side Frame Profile
2,515kg/mt

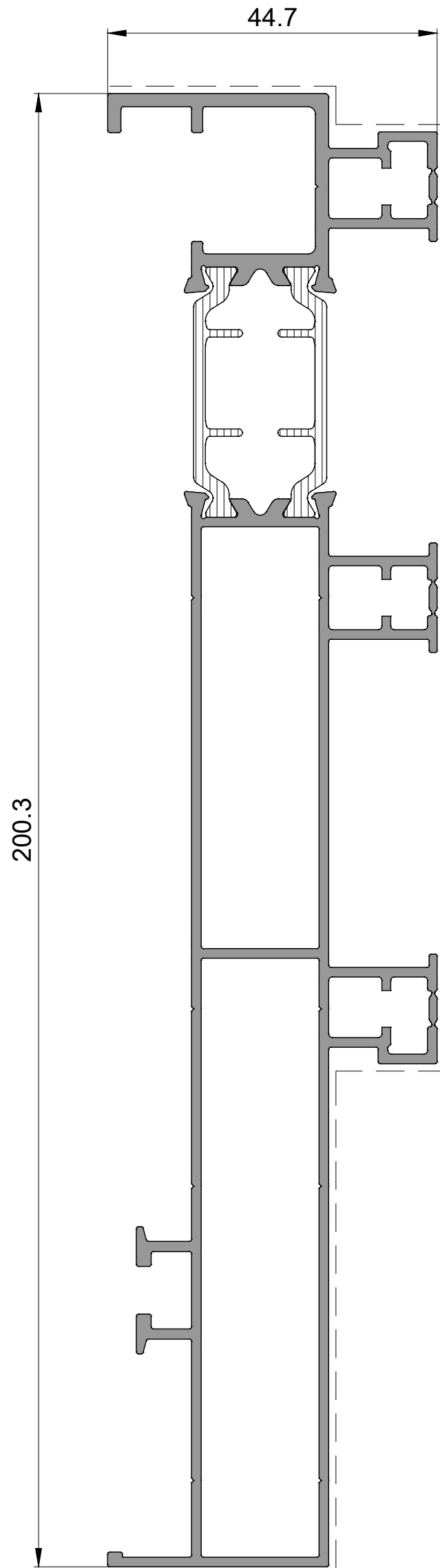

P 2571

Üst Kasa Profili
Top Frame Profile
2,810kg/mt

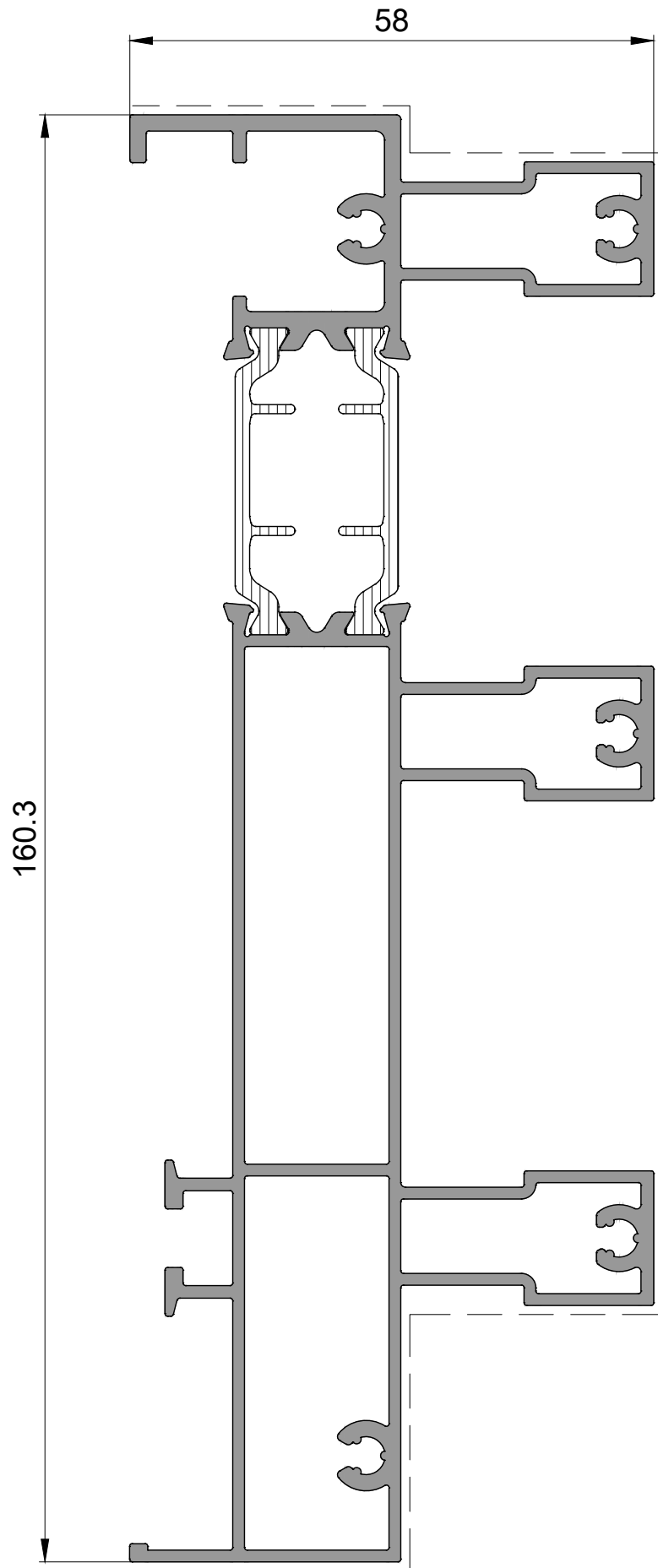

P 2572

Üst Kasa Profili
Top Frame Profile
3,155kg/mt

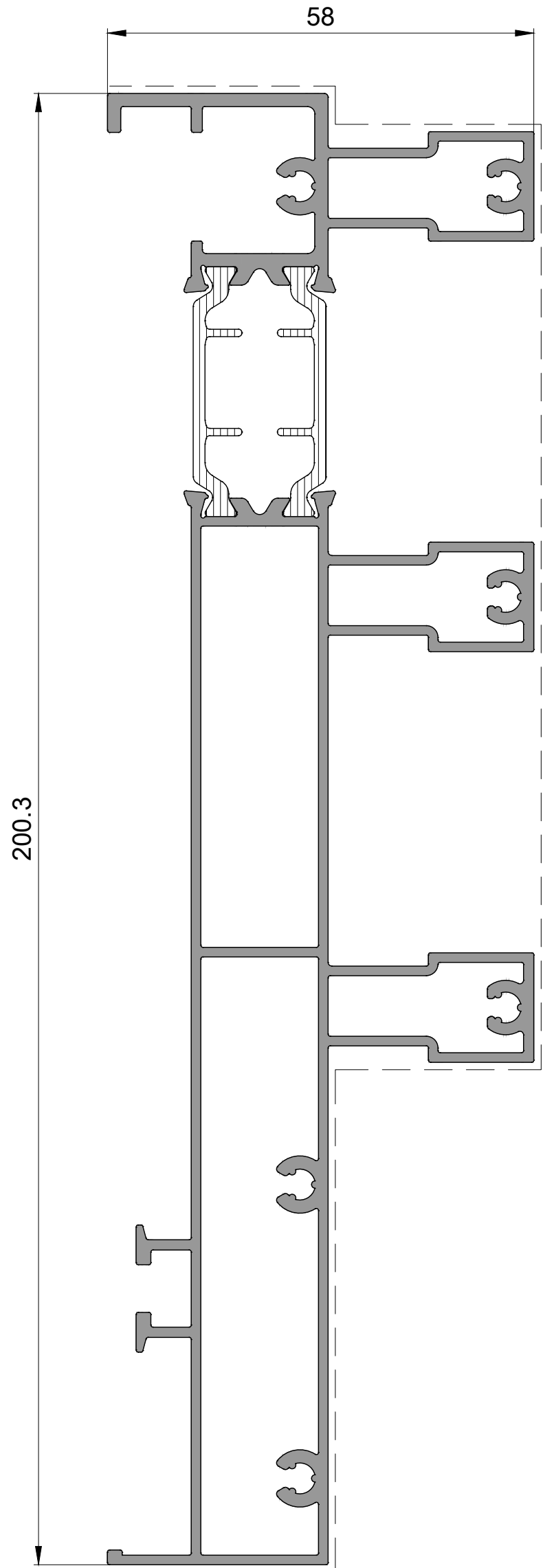

P 2573
Alt Kasa Profili
Bottom Frame Profile
3,615kg/mt

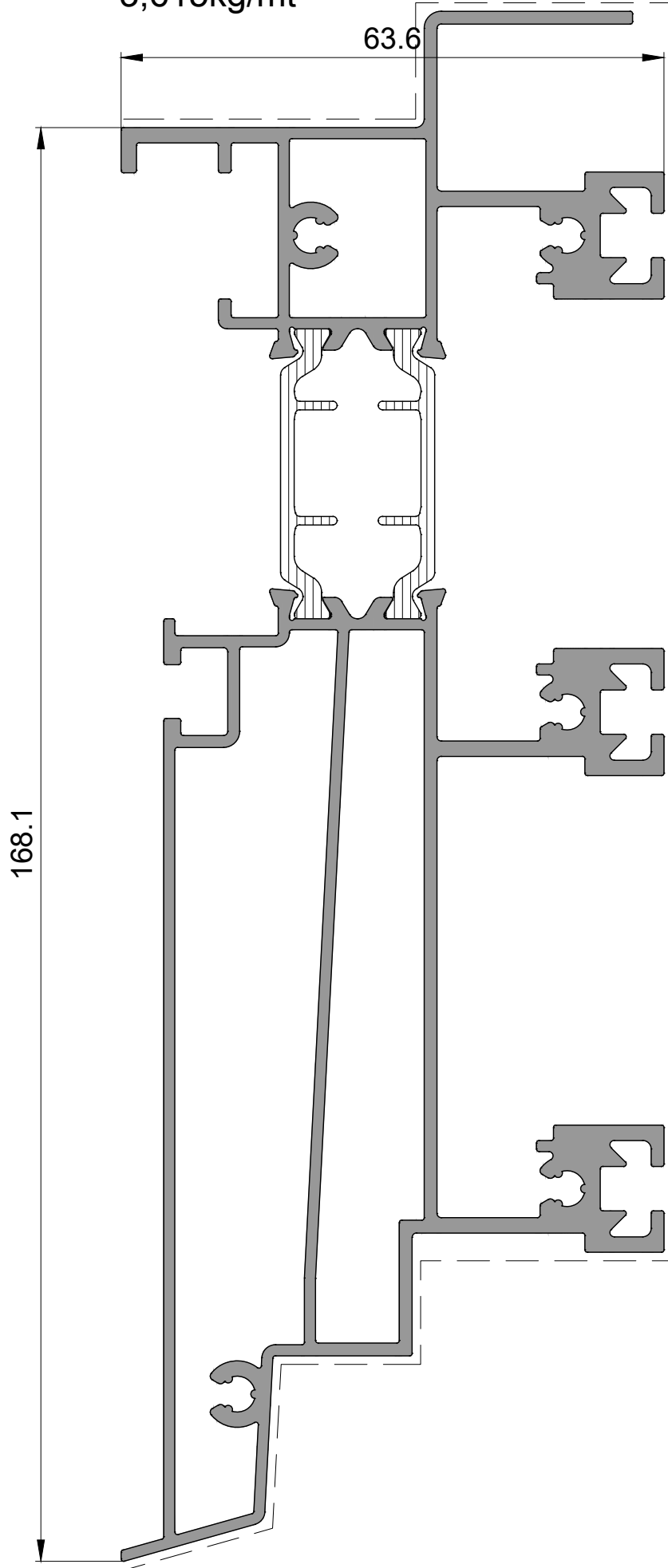

P 2574
Üst Kasa Profili
Top Frame Profile
1,910kg/mt

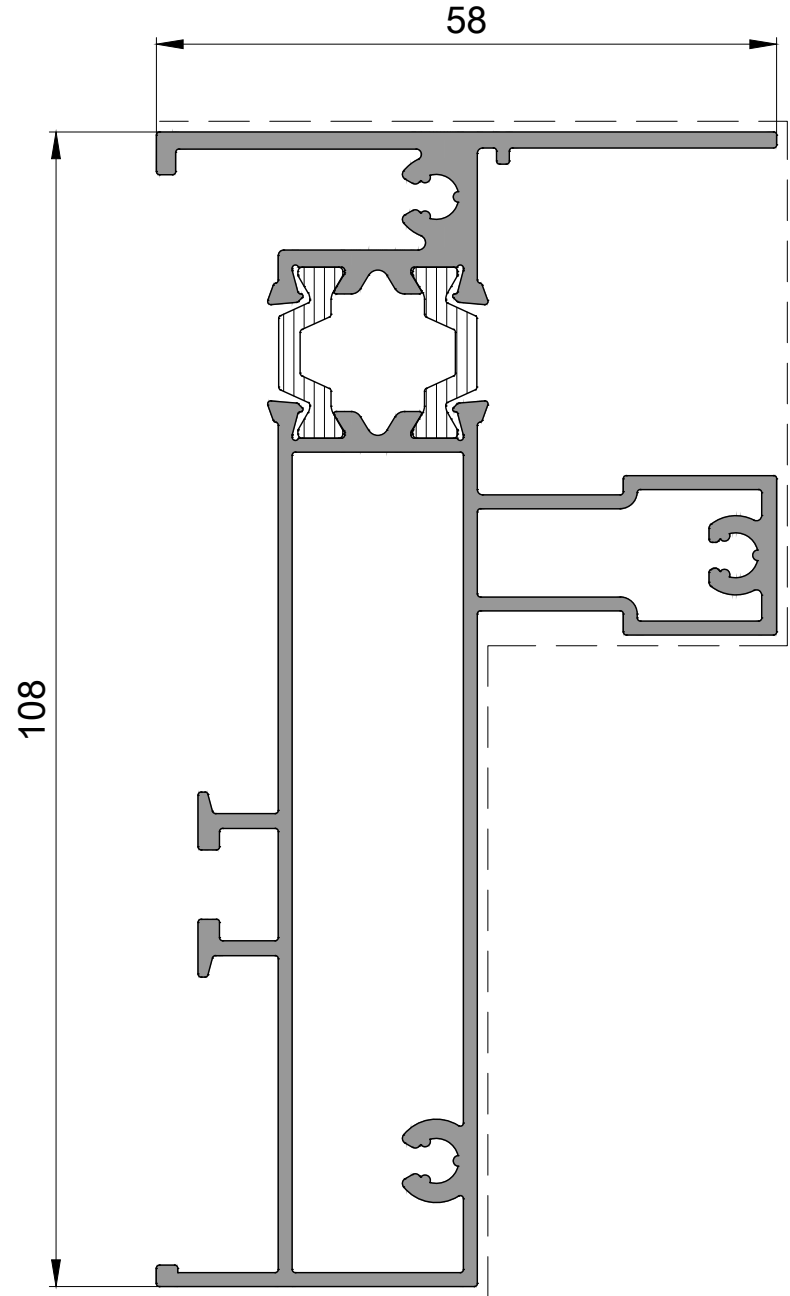

P 2488
Ray Profili / Rail Profile
0,170kg/mt

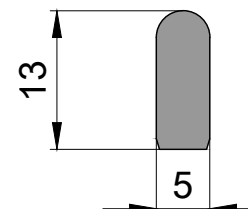

Kalıp No : 19678
(die no)

P 2575
Yan Kasa Profili
Side Frame Profile
1,510kg/mt

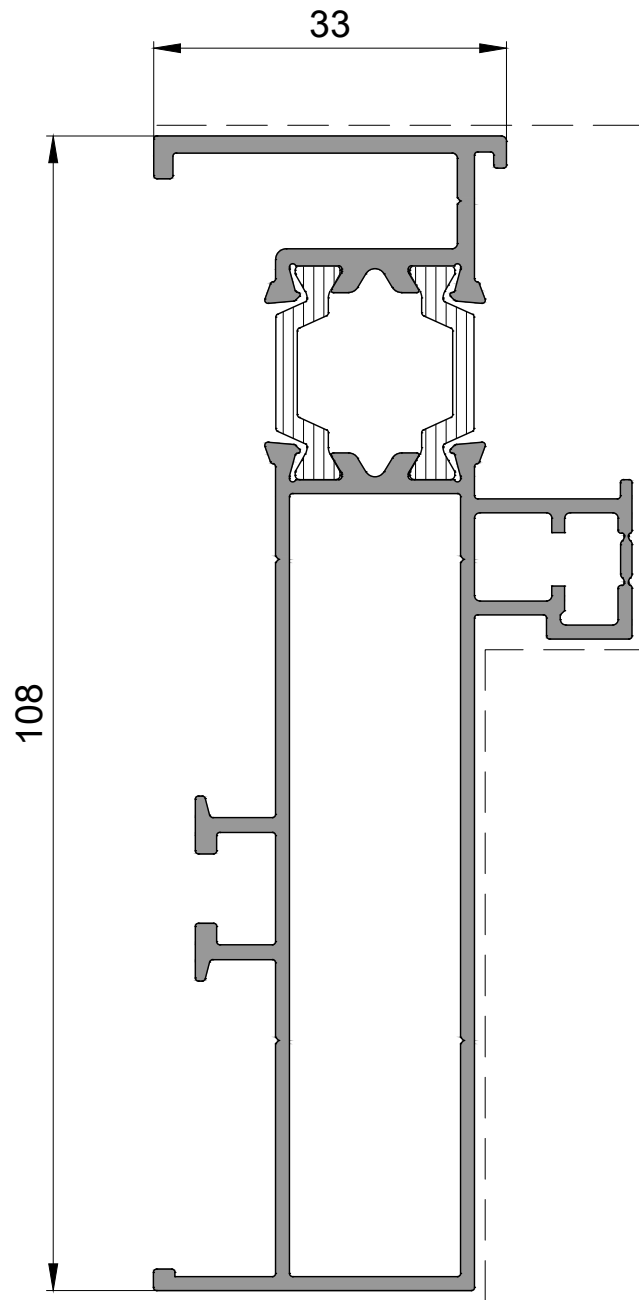

P 2576
Alt Kasa Profili
Bottom Frame Profile
1,855kg/mt

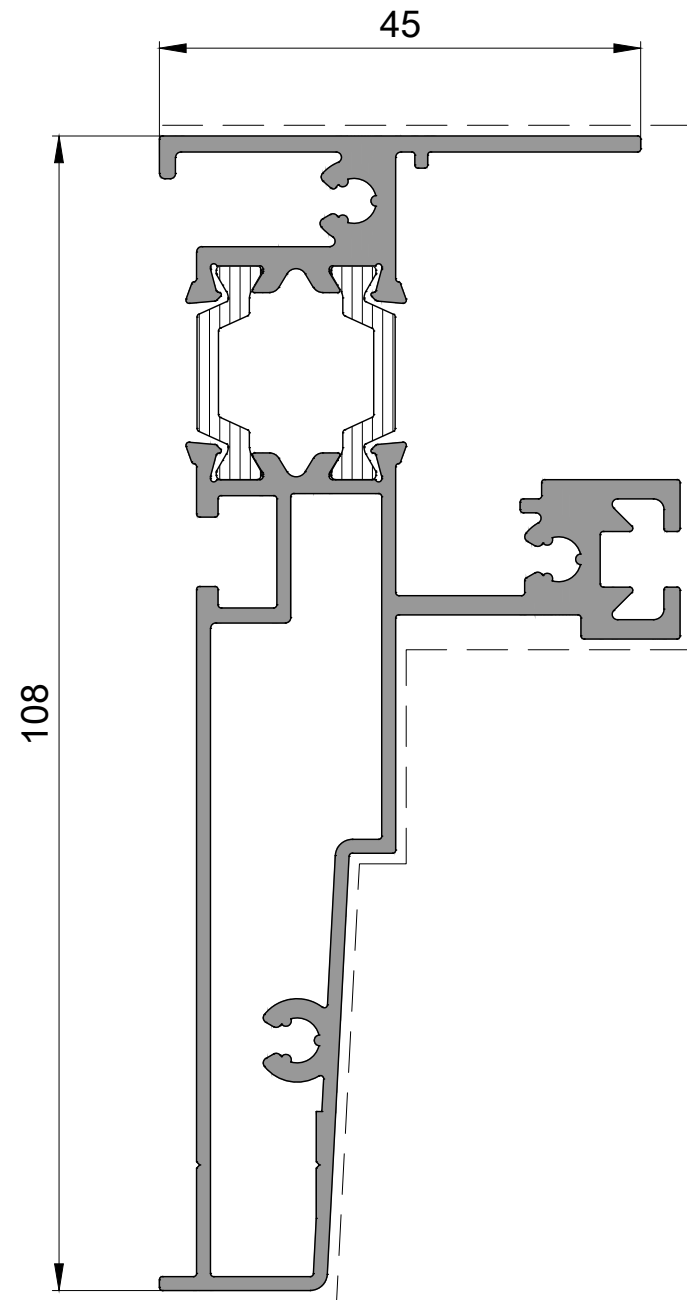

P 2577
Dış Kenet Profili
External Interlock Profile
0,860kg/mt

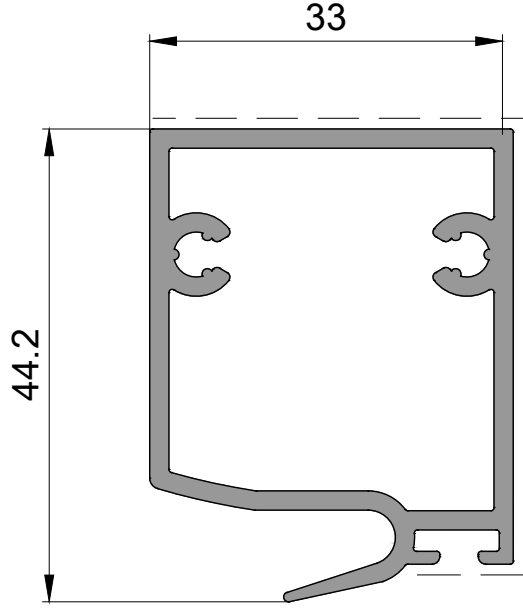

P 2578
Üst Kasa Profili
Top Frame Profile
2,275kg/mt

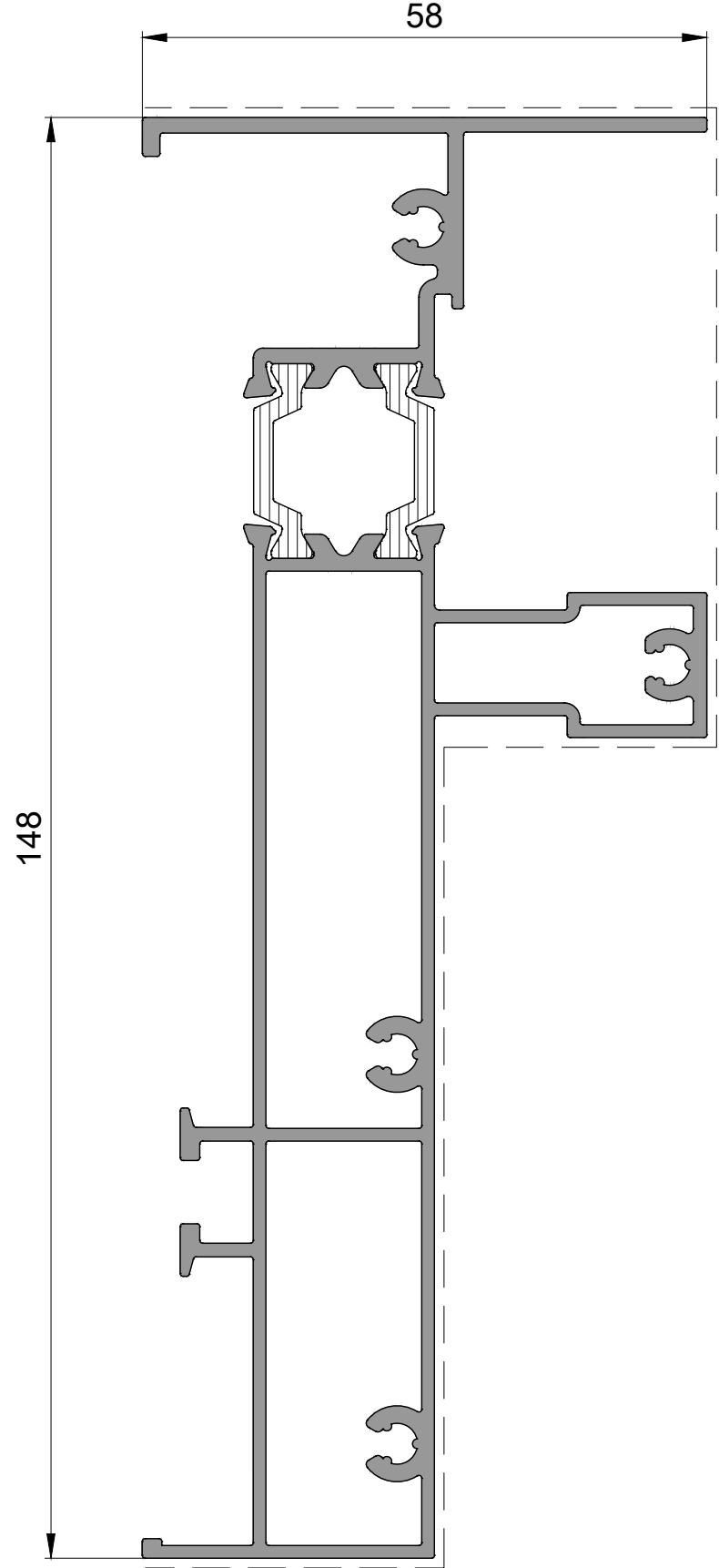

P 2579
Yan Kasa Profili
Side Frame Profile
1,810kg/mt

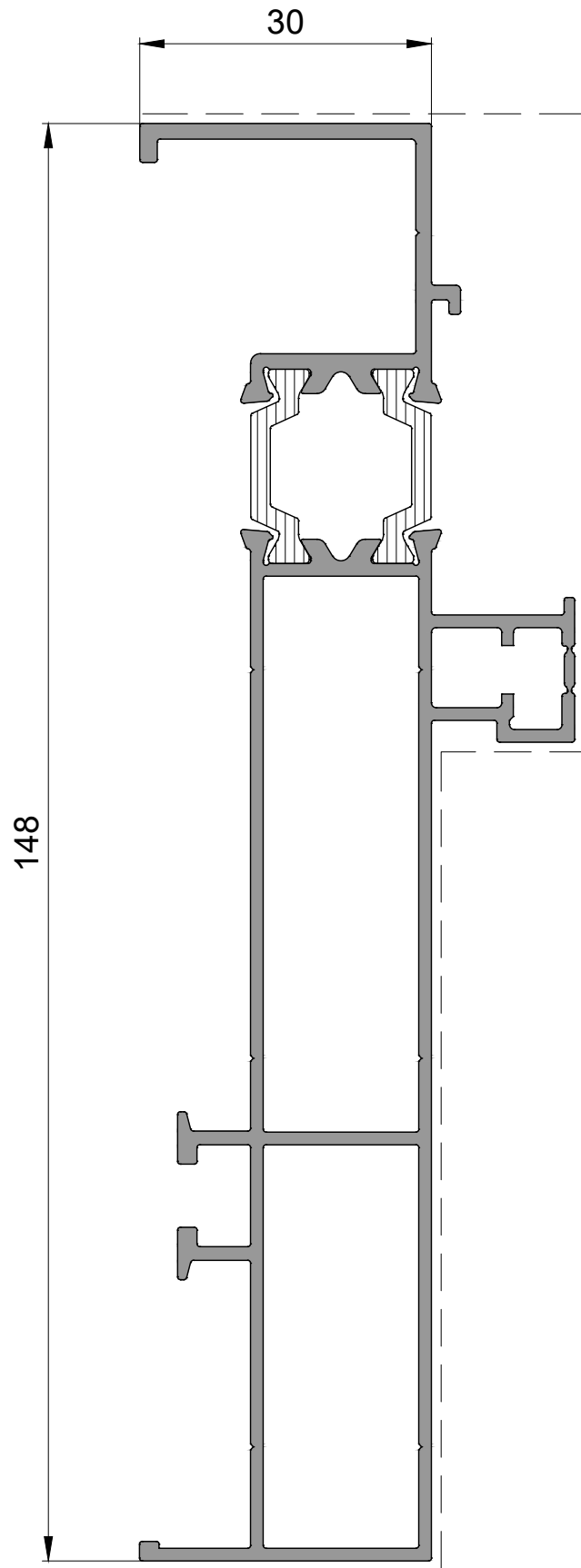

P 2580
Alt Kasa Profili
Bottom Frame Profile
2,195kg/mt

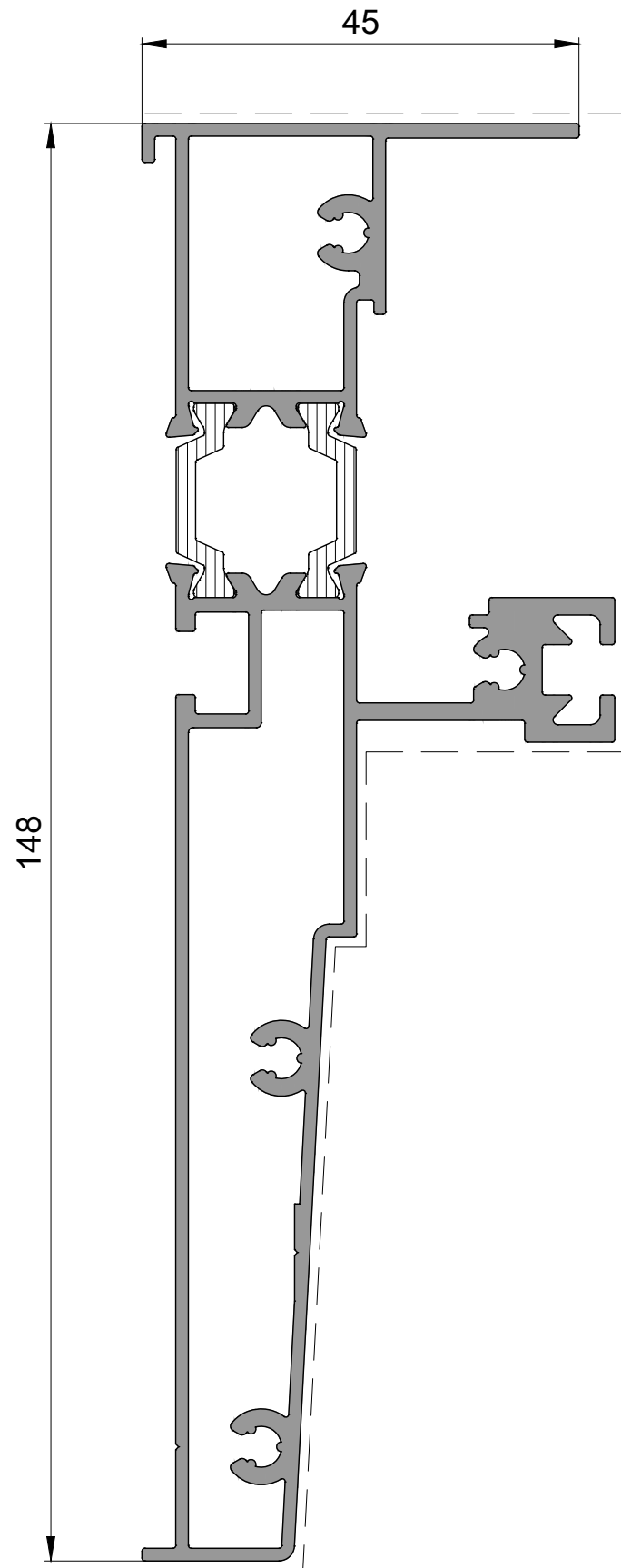

P 2581
Dış Kenet Profili
External Interlock Profile
1,090kg/mt

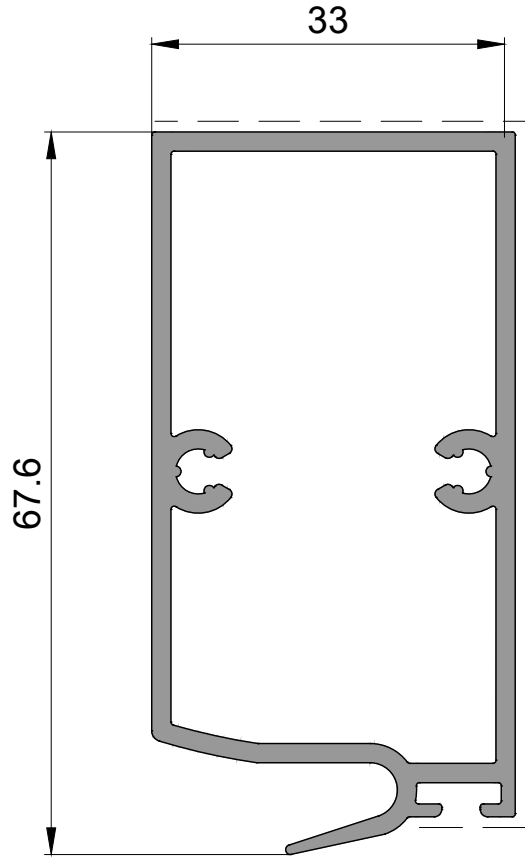

P 2582
Üst Kasa Profili
Top Frame Profile
2,440kg/mt

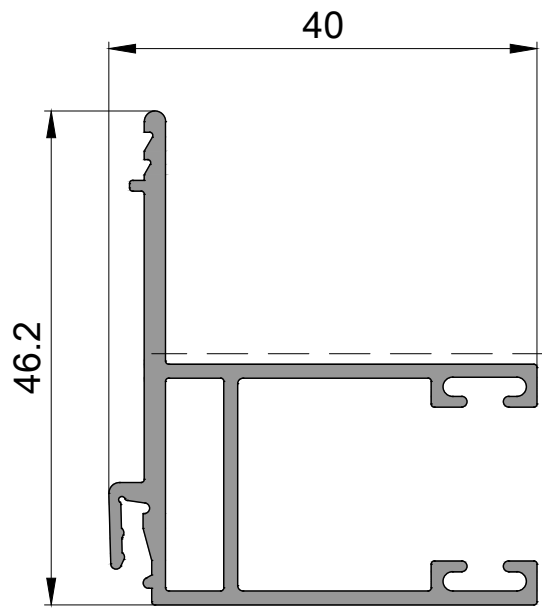
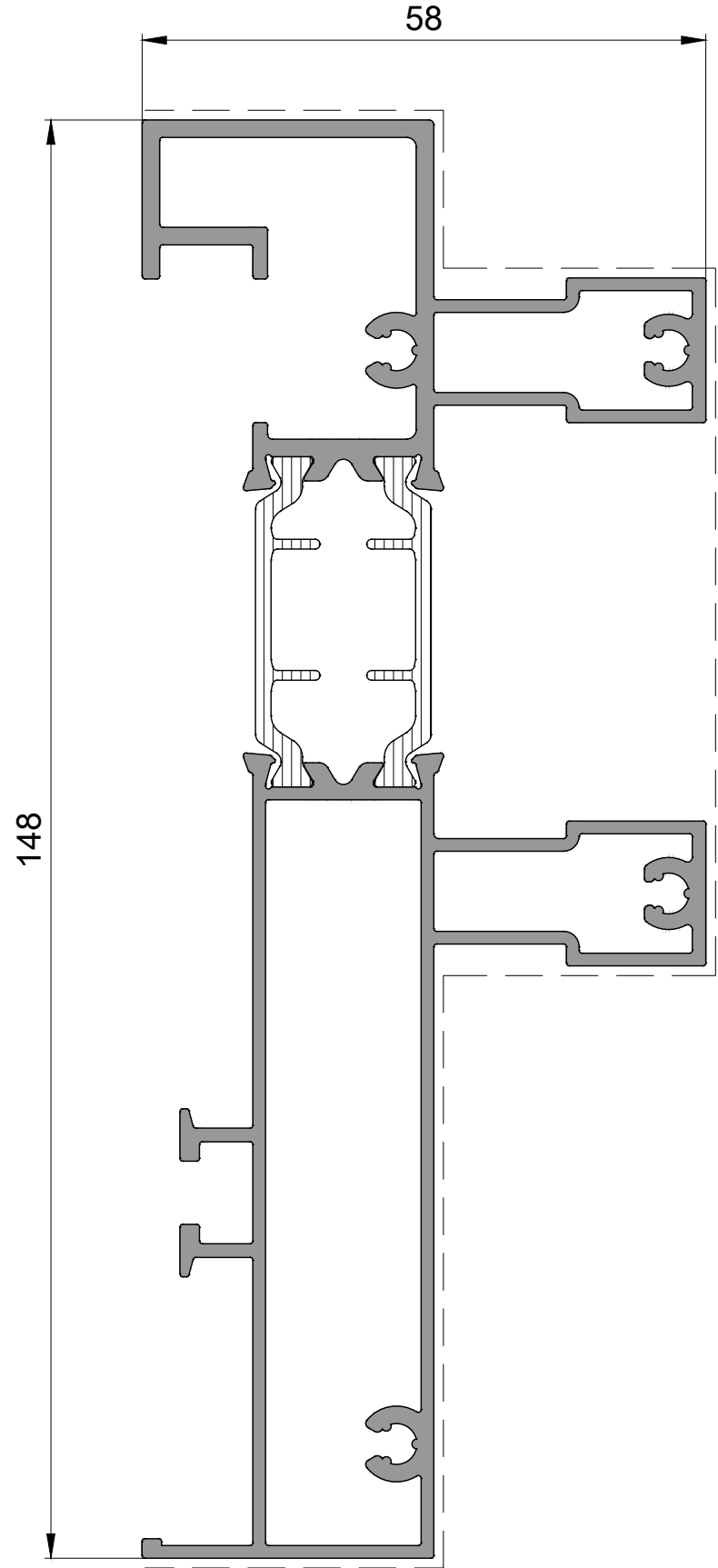

P 2591
Panjur Kanal Profili
Roller Rail Profile
0,645kg/mt

P 2583
Yan Kasa Profili
Side Frame Profile
1,885kg/mt

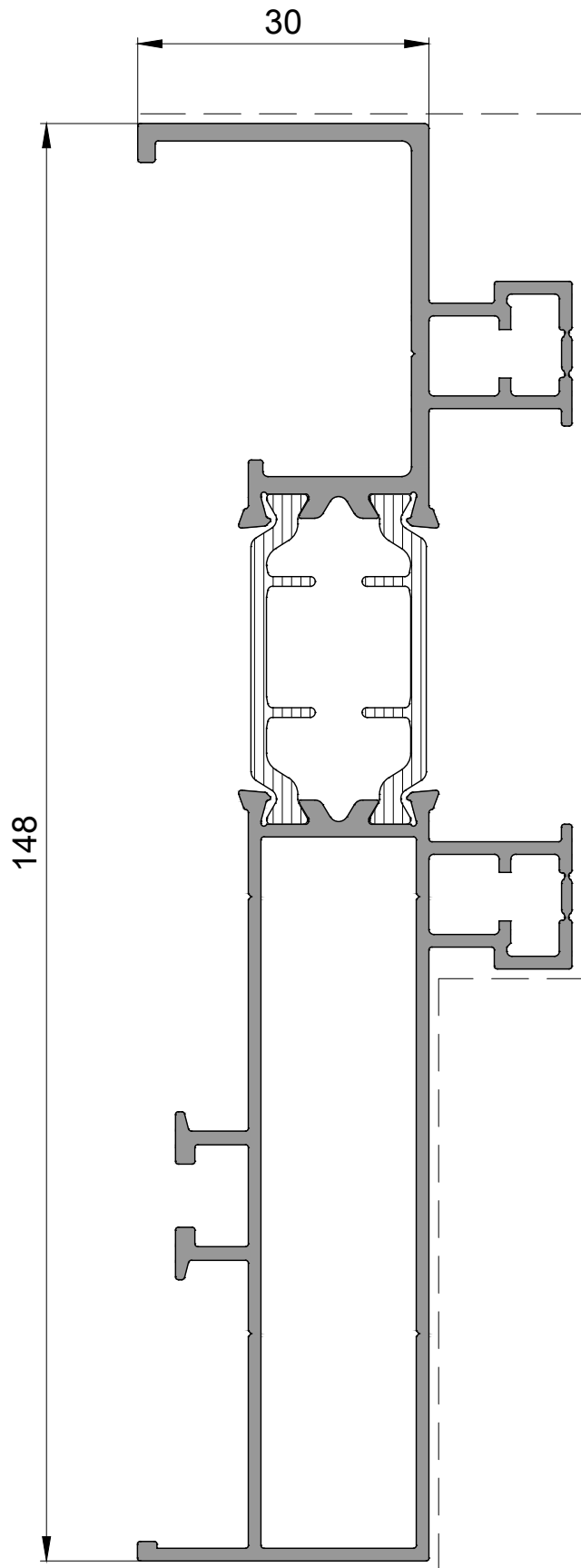

P 2584
Alt Kasa Profili
Bottom Frame Profile
2,490kg/mt

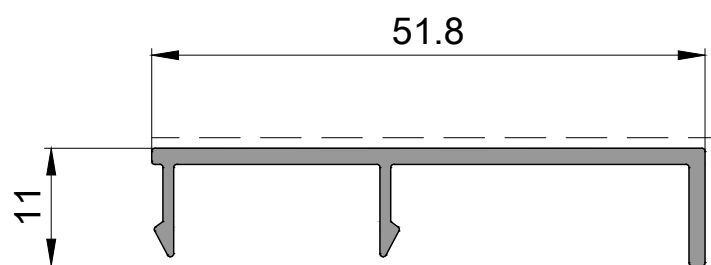
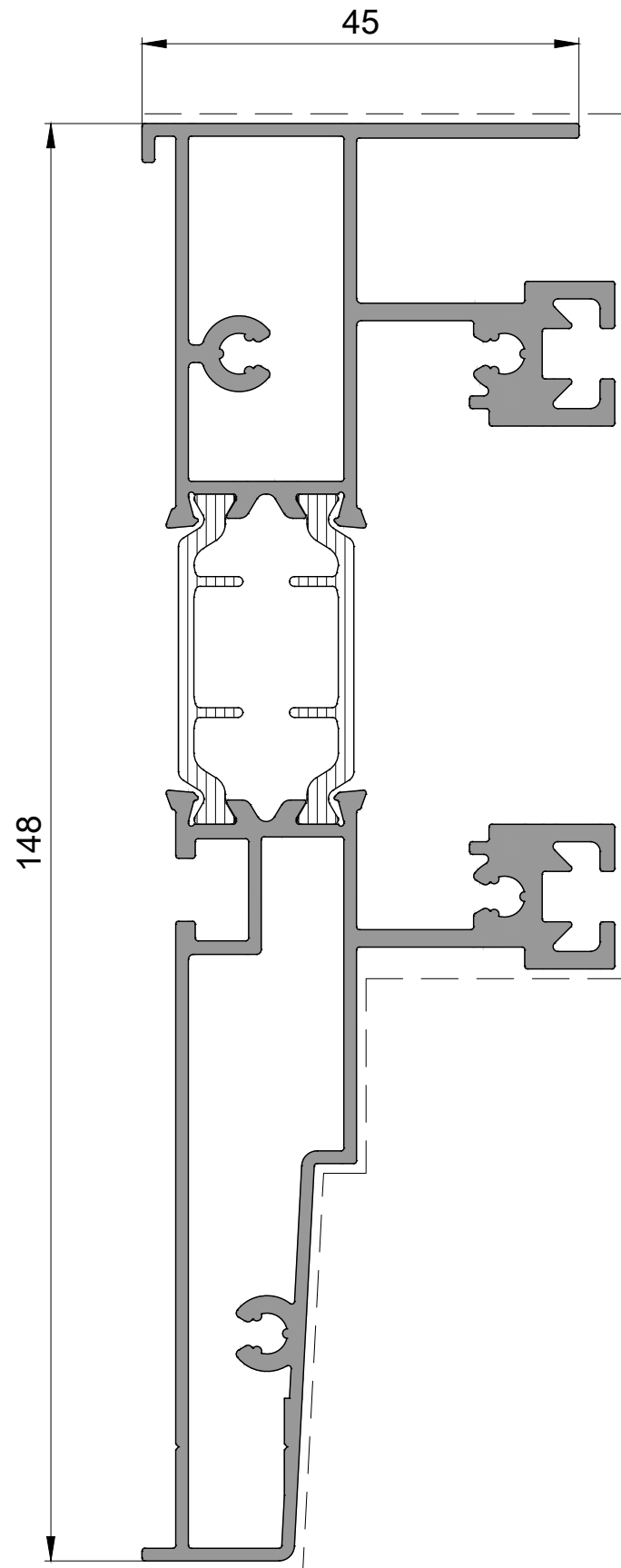

P 2588
Kapatma Profili
Closing Profile
0,300kg/mt

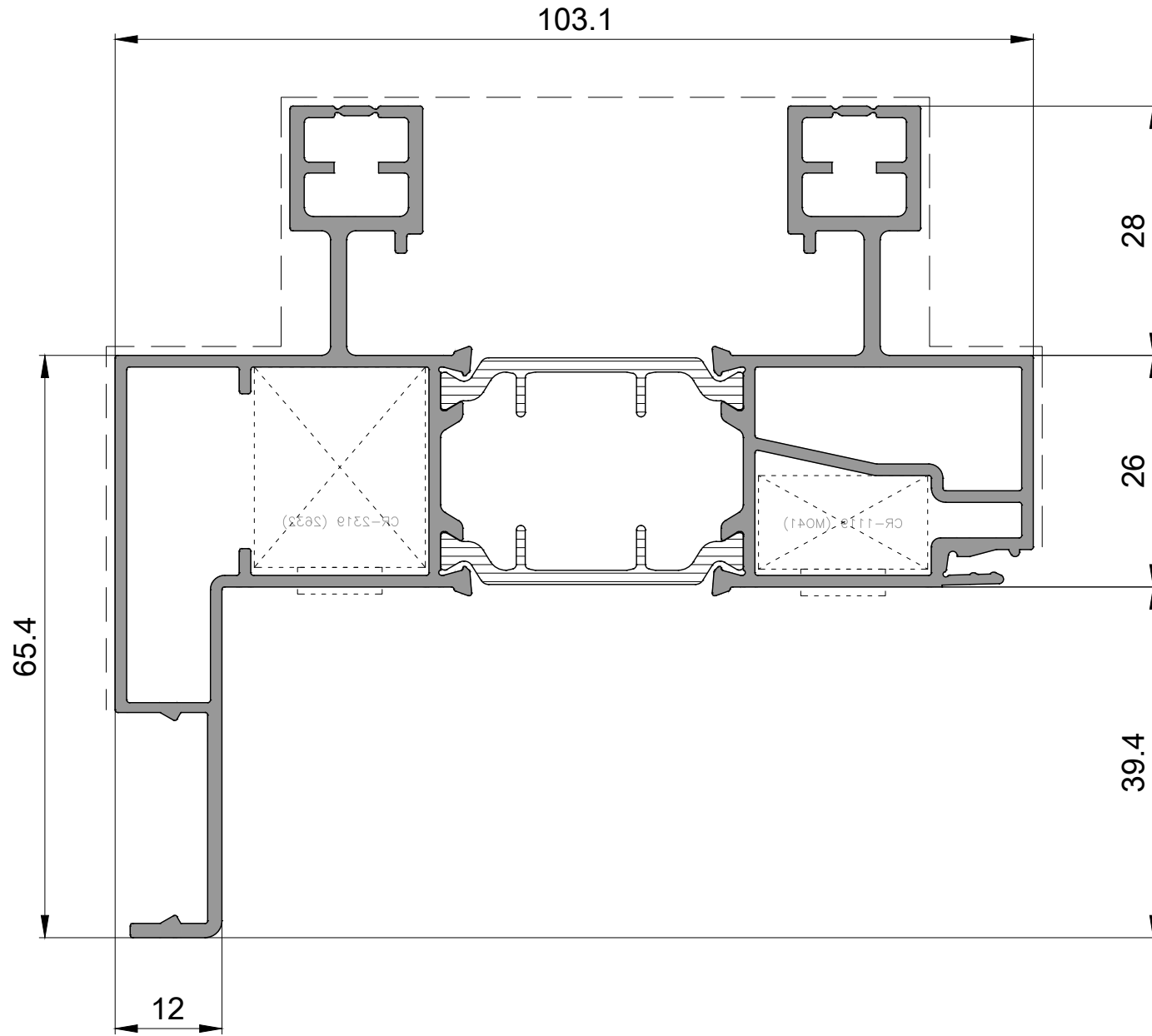

P 2585
Yan Kasa Profili
Side Frame Profile
2,205kg/mt

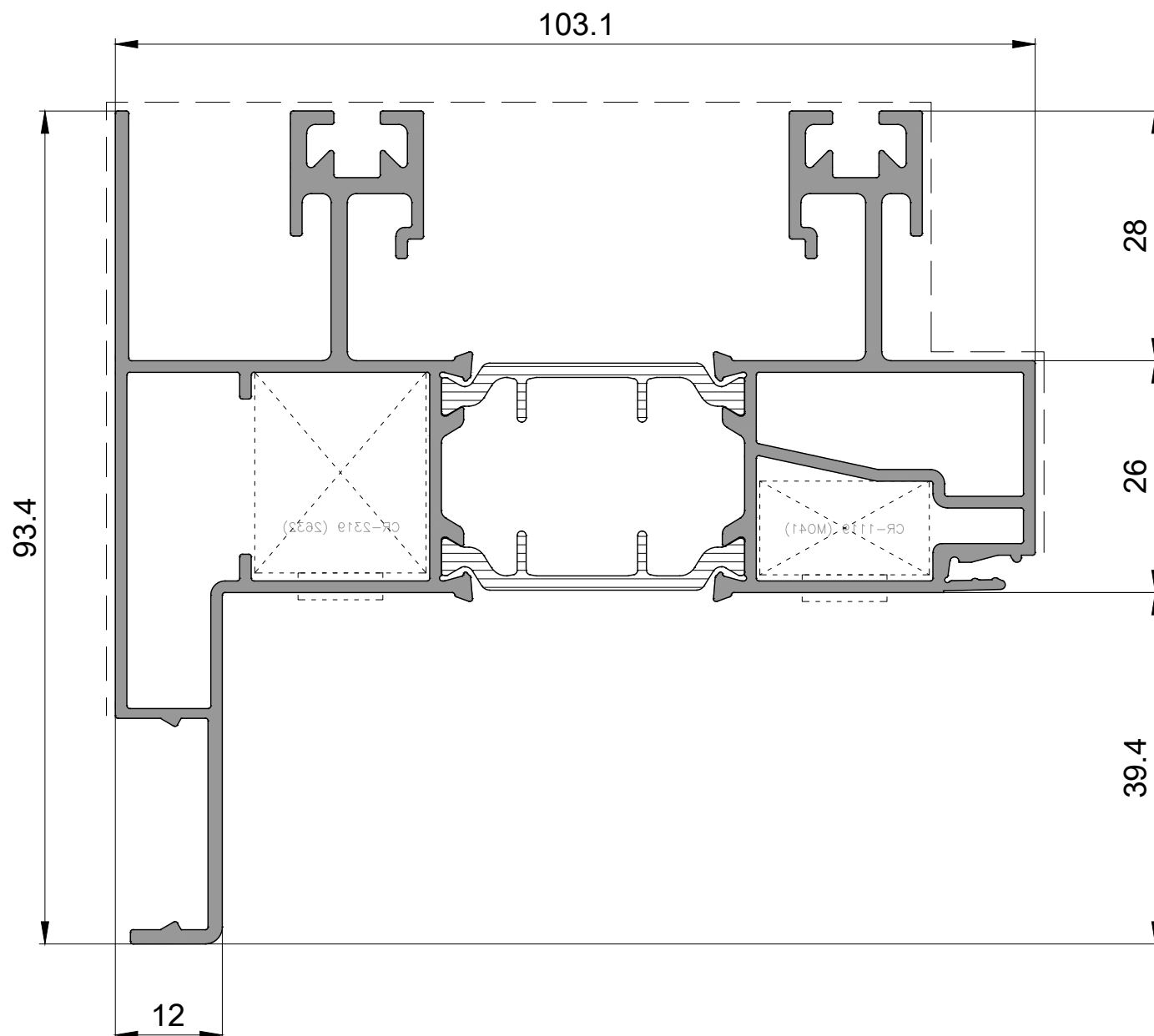

P 2586
Alt Kasa Profili
Bottom Frame Profile
2,390kg/mt

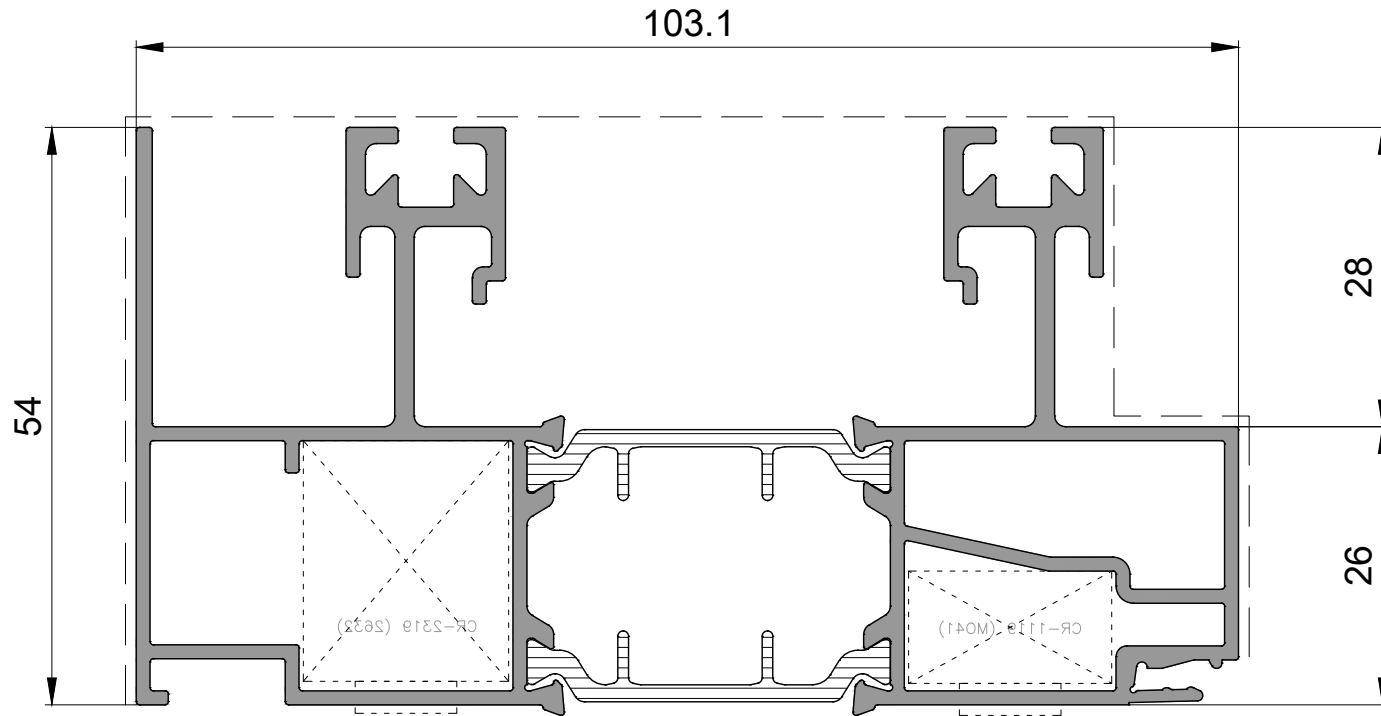

P 2587
Alt Kasa Profili
Bottom Frame Profile
2,150kg/mt

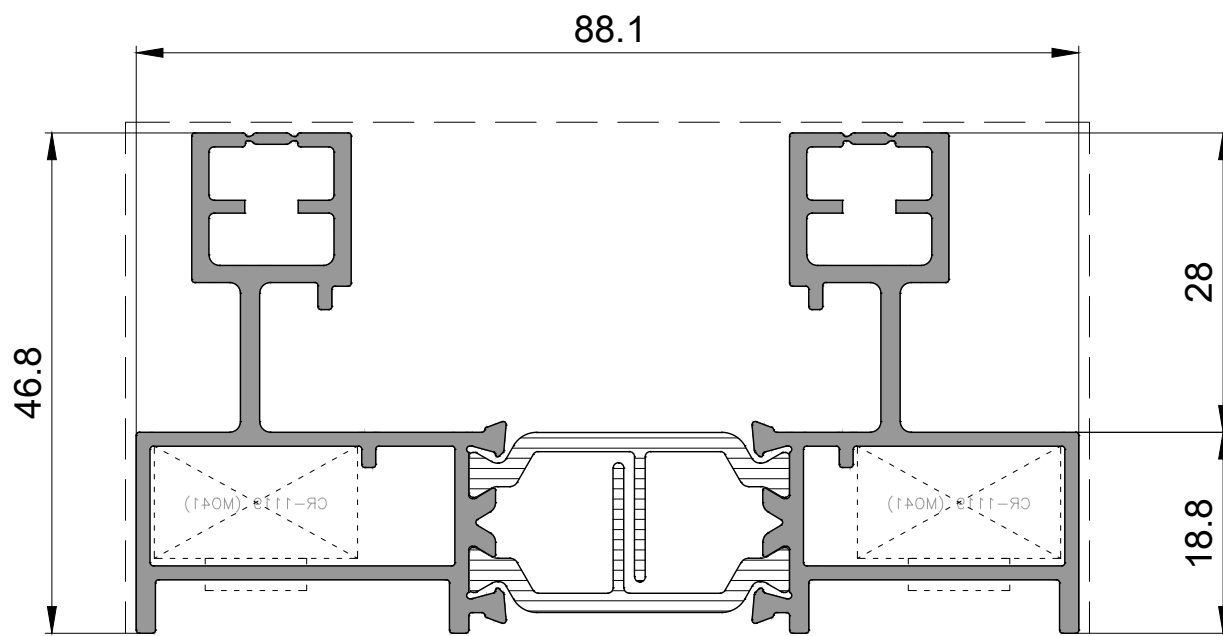

P 2589
Yan Kasa Profili
Side Frame Profile
1,650kg/mt

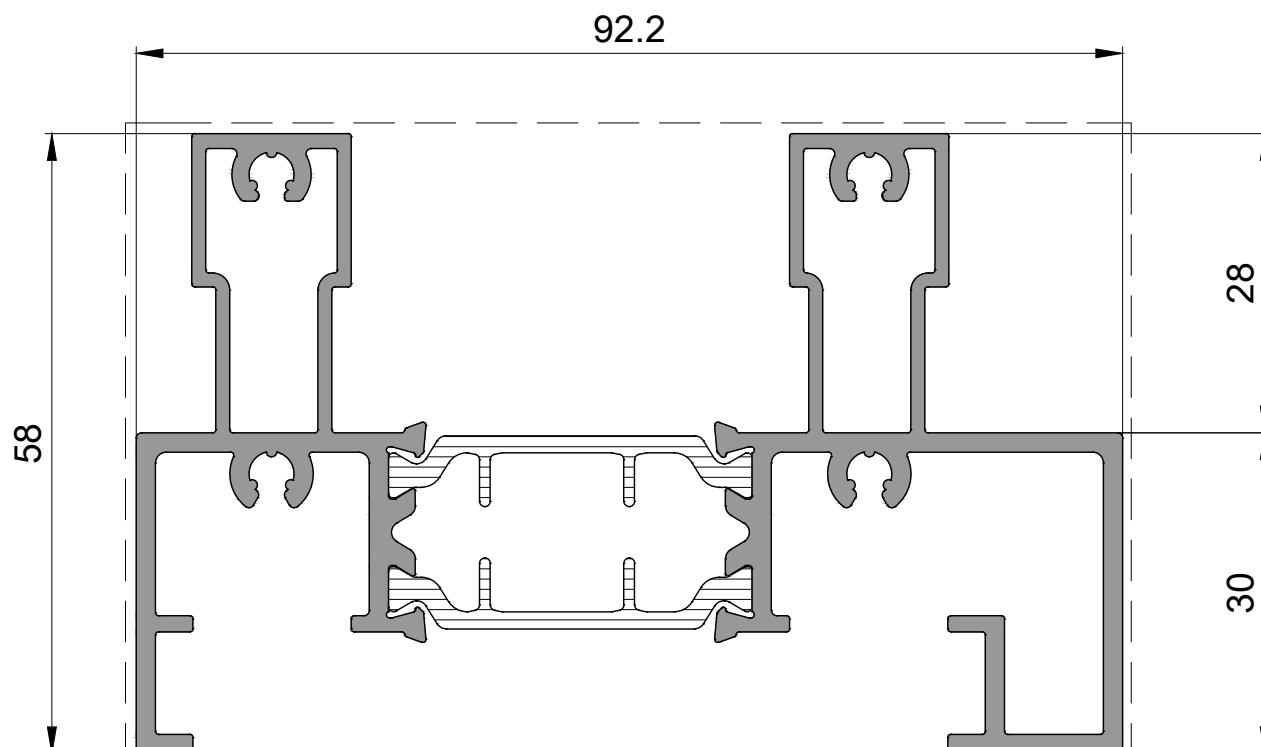

P 2590
Üst Kasa Profili
Top Frame Profile
2,000kg/mt

MOTIONslide
SÜRME KAPI ve PENCERE SİSTEMİ
SLIDING WINDOW and DOOR SYSTEM

2 RAYLI SÜRME
PRENSİP SİSTEM DETAYLARI
PRINCIPAL SECTIONS for
DOUBLE RAIL SLIDING SYSTEM

100mm YALITIMLI SOL YAN DETAY
100mm isolation with left side detail

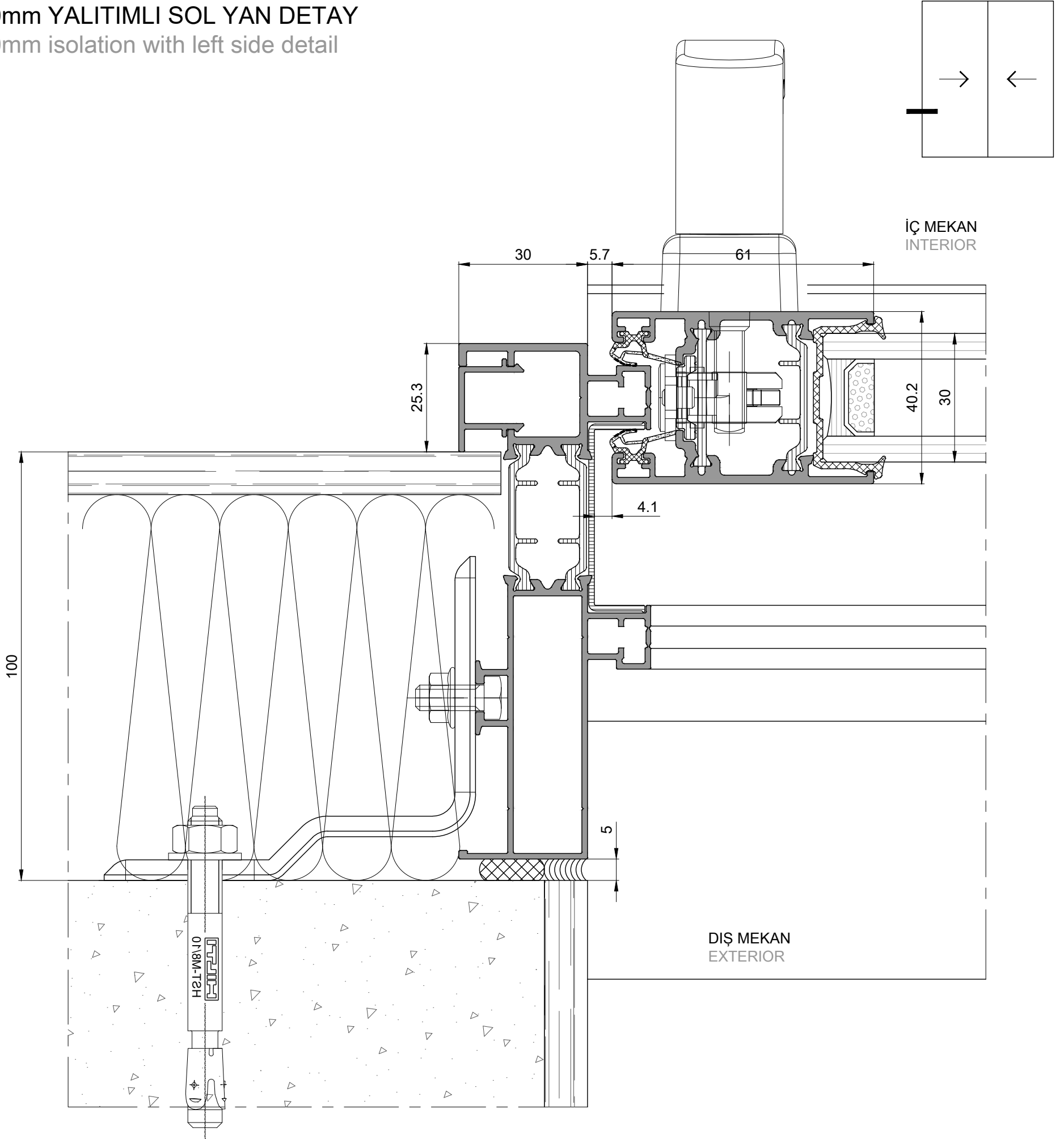

120mm YALITIMLI SOL YAN DETAY
120mm isolation with left side detail

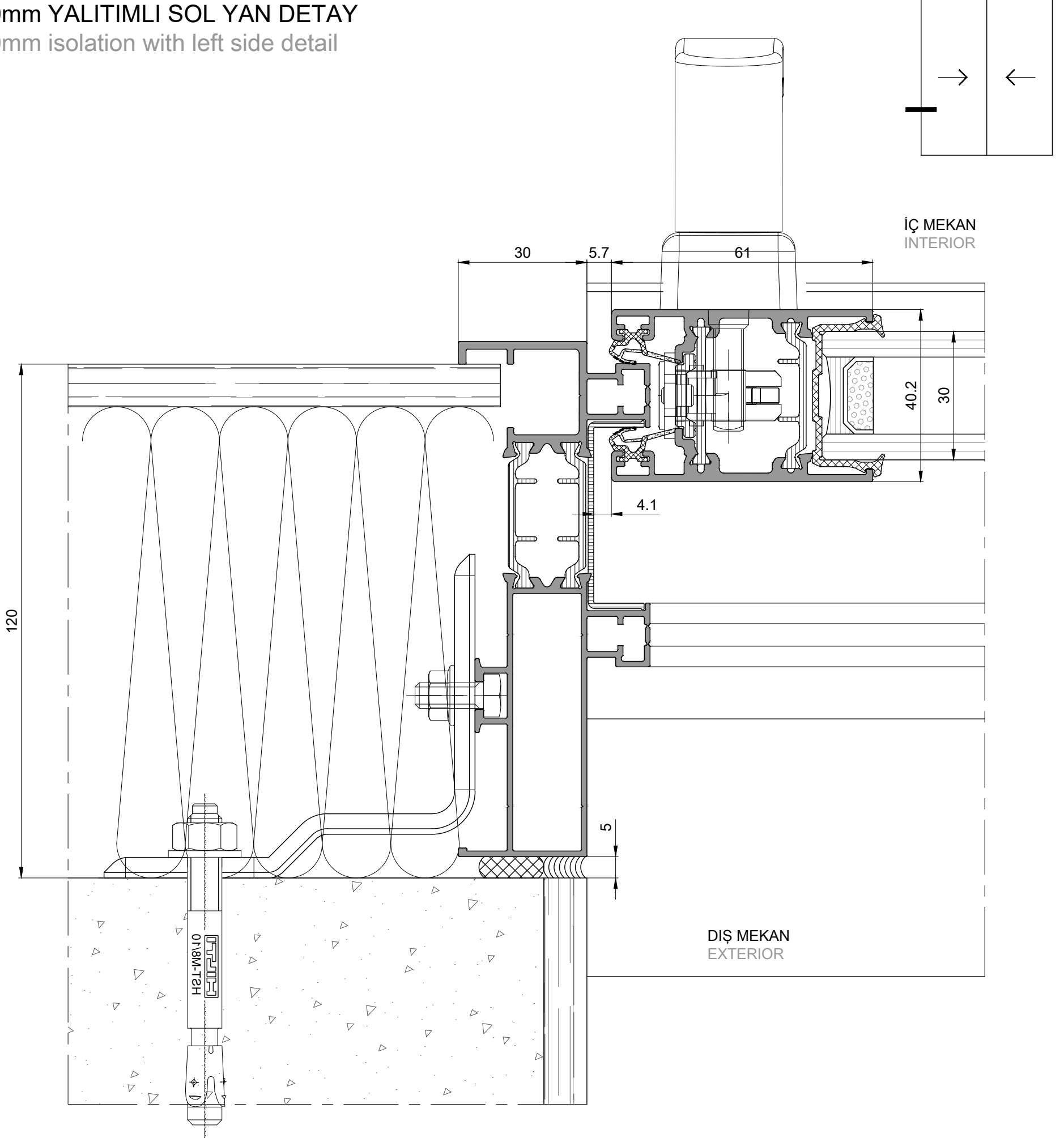

140mm YALITIMLI SOL YAN DETAY
140mm isolation with left side detail

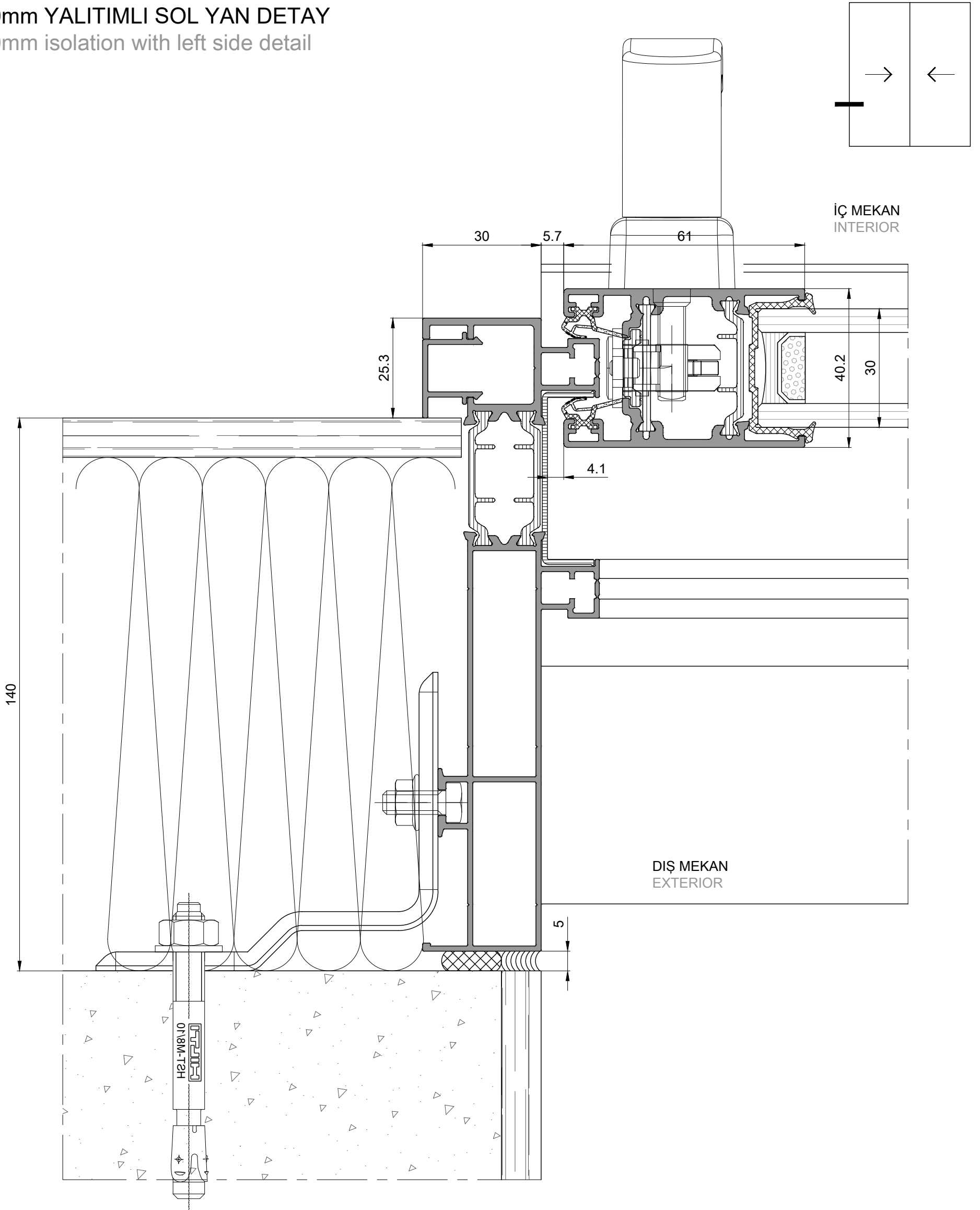

160mm YALITIMLI SOL YAN DETAY
160mm isolation with left side detail

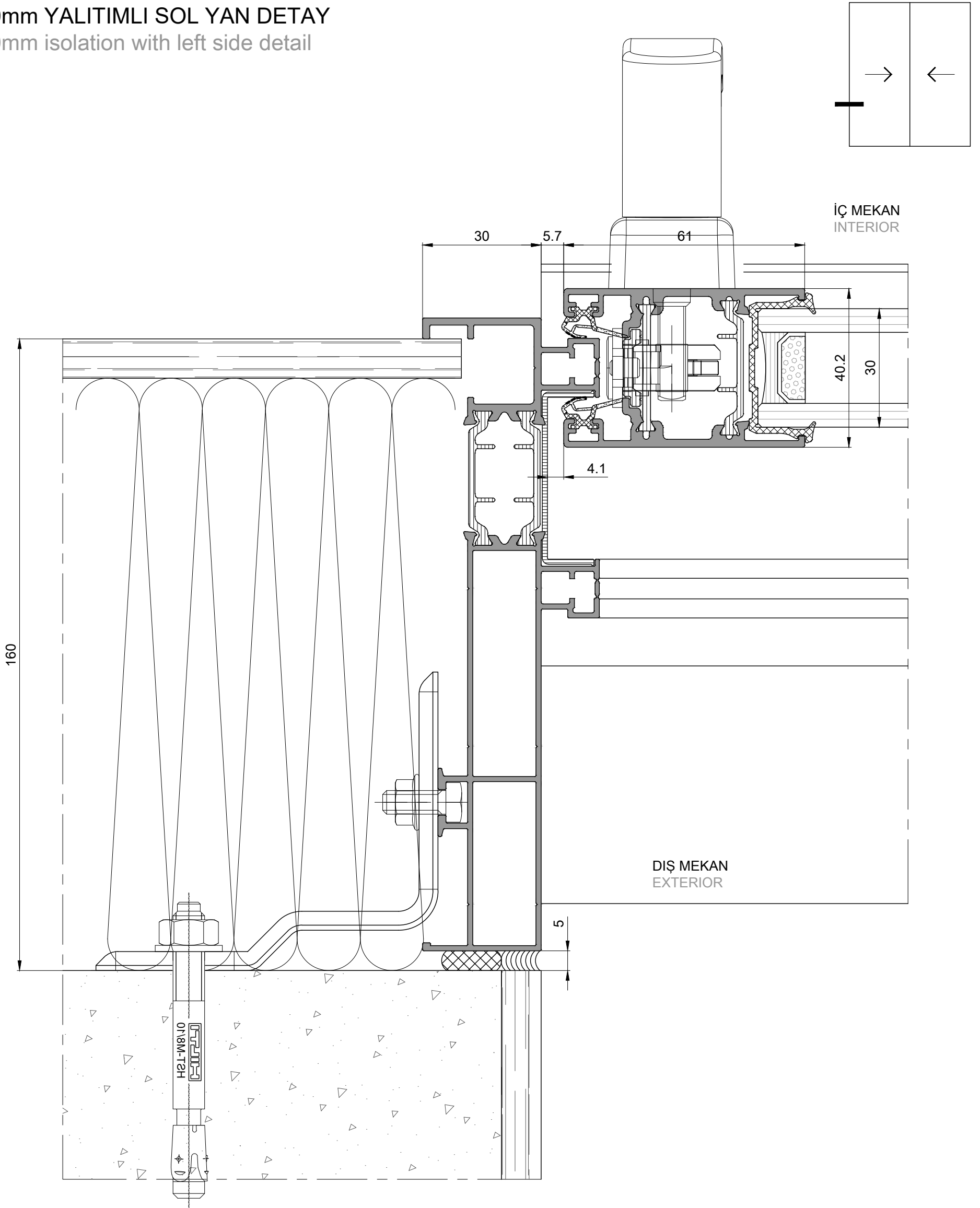

180mm YALITIMLI SOL YAN DETAY
180mm isolation with left side detail

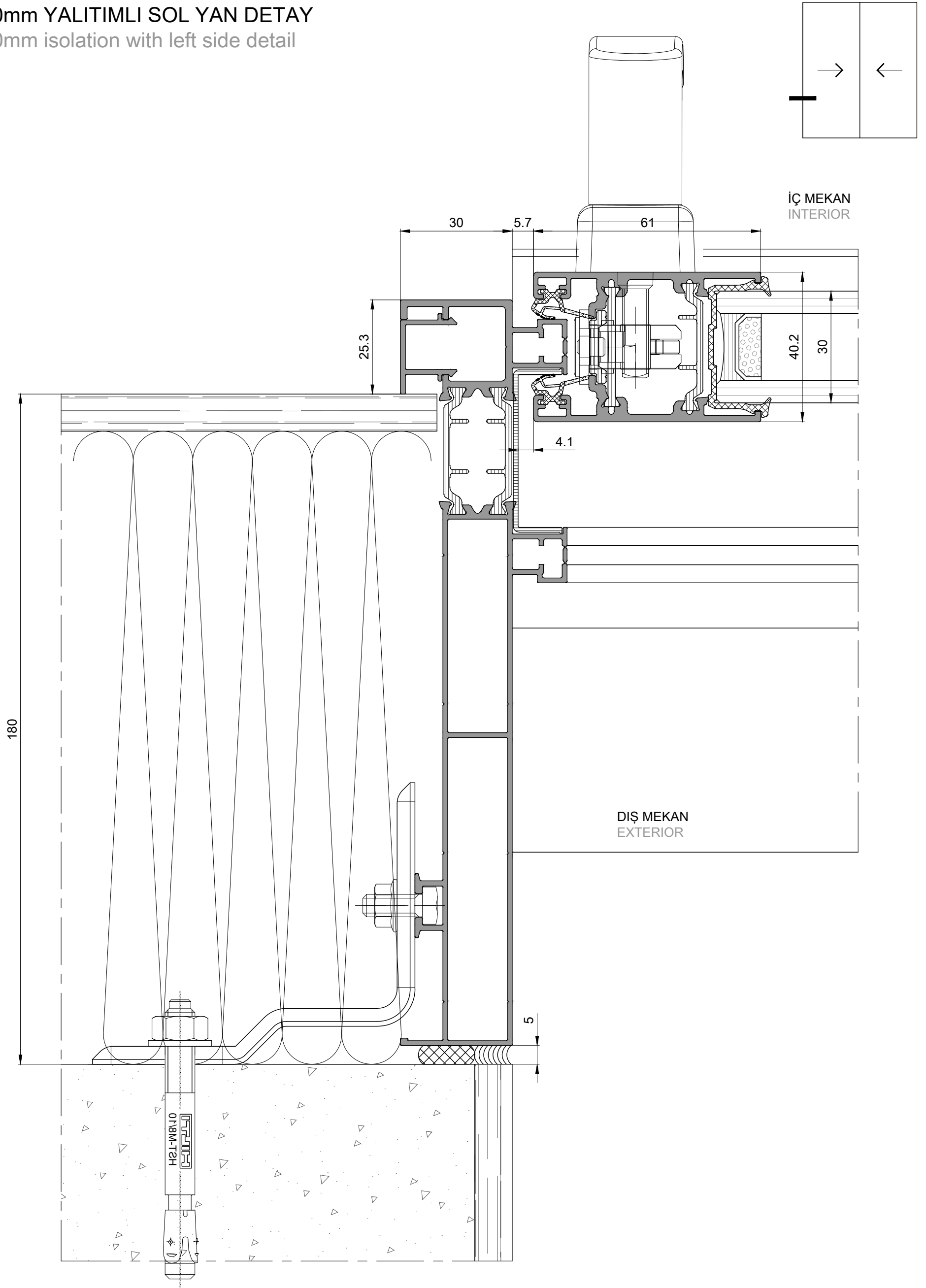

200mm YALITIMLI SOL YAN DETAY
200mm isolation with left side detail

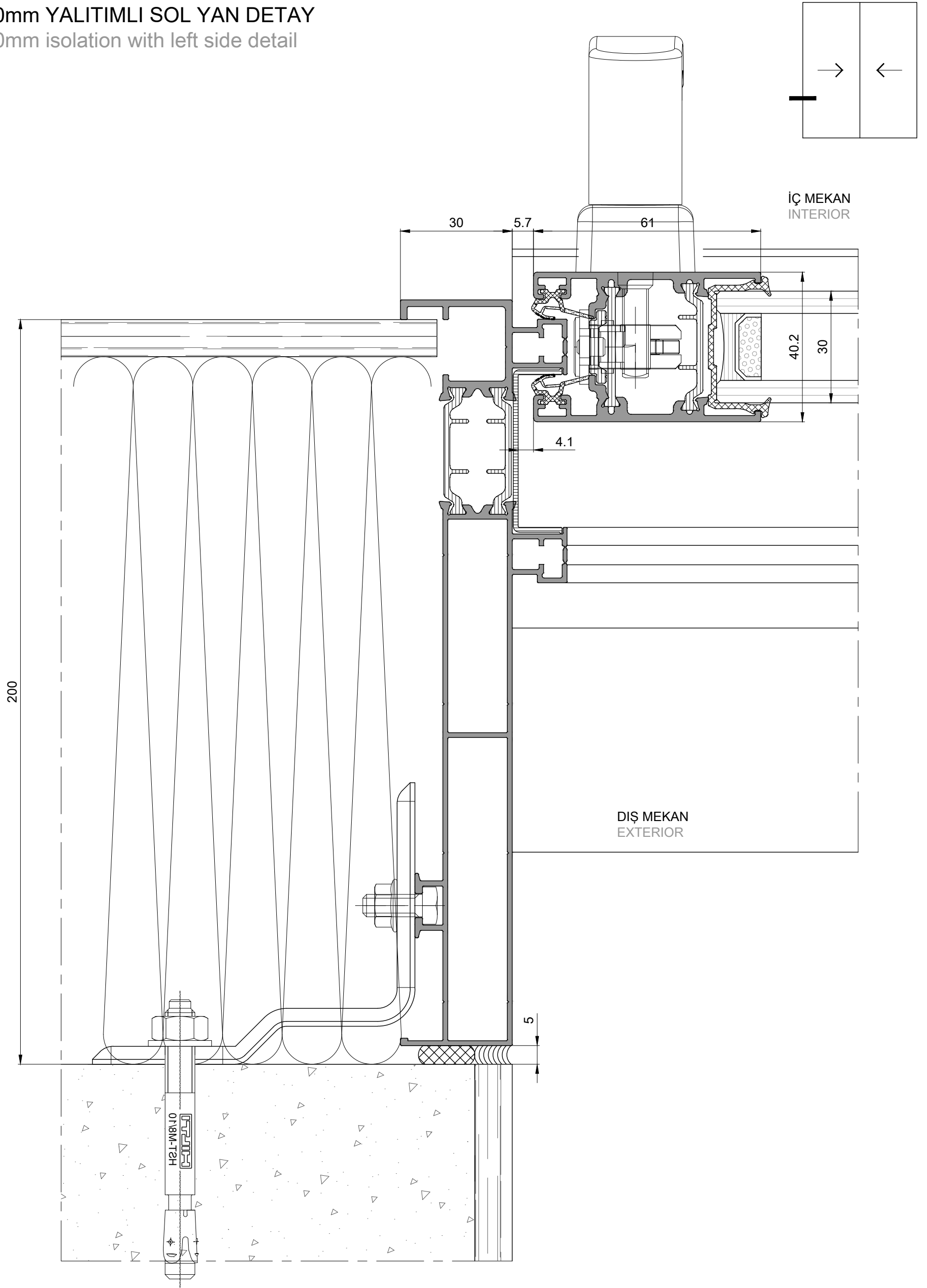

KENET DETAY
interlock detail

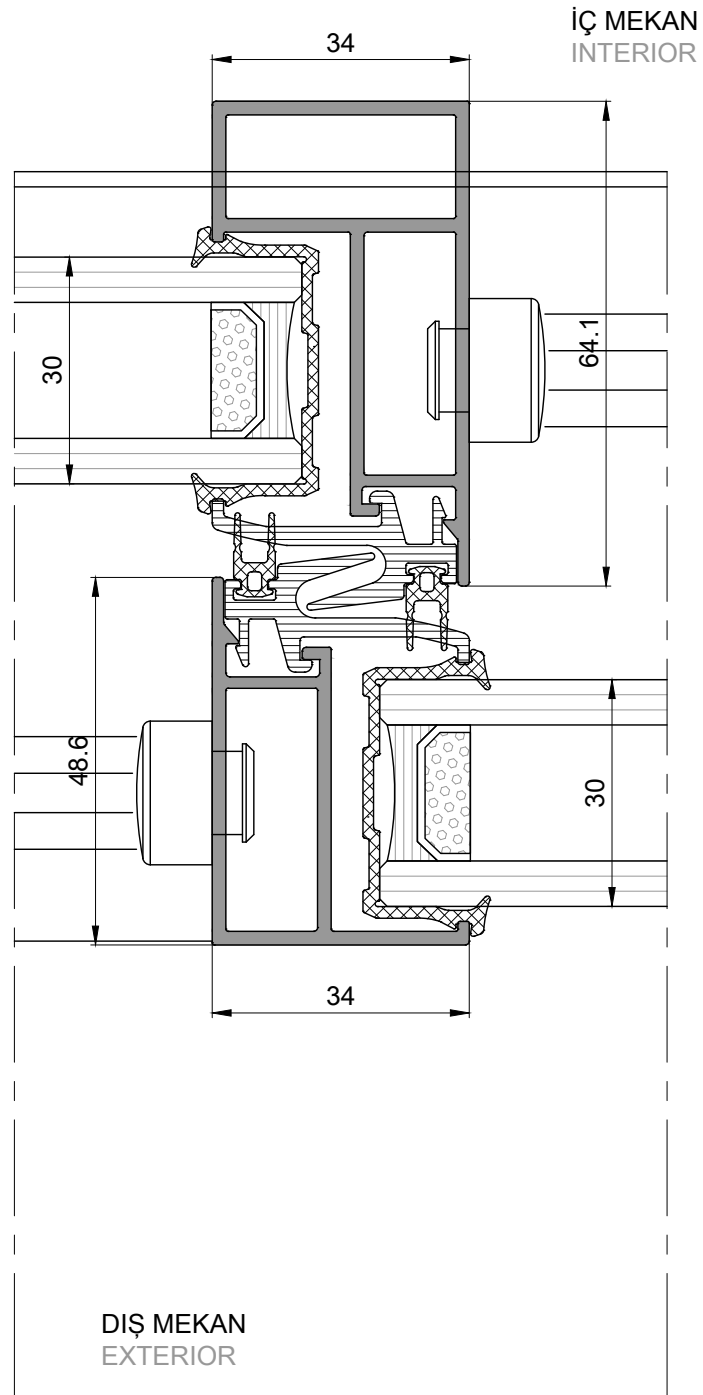
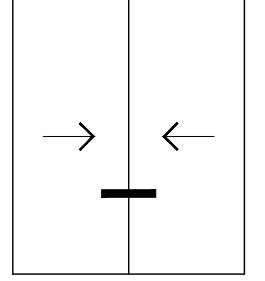

ÇİFT KANAT DETAY
double sash detail

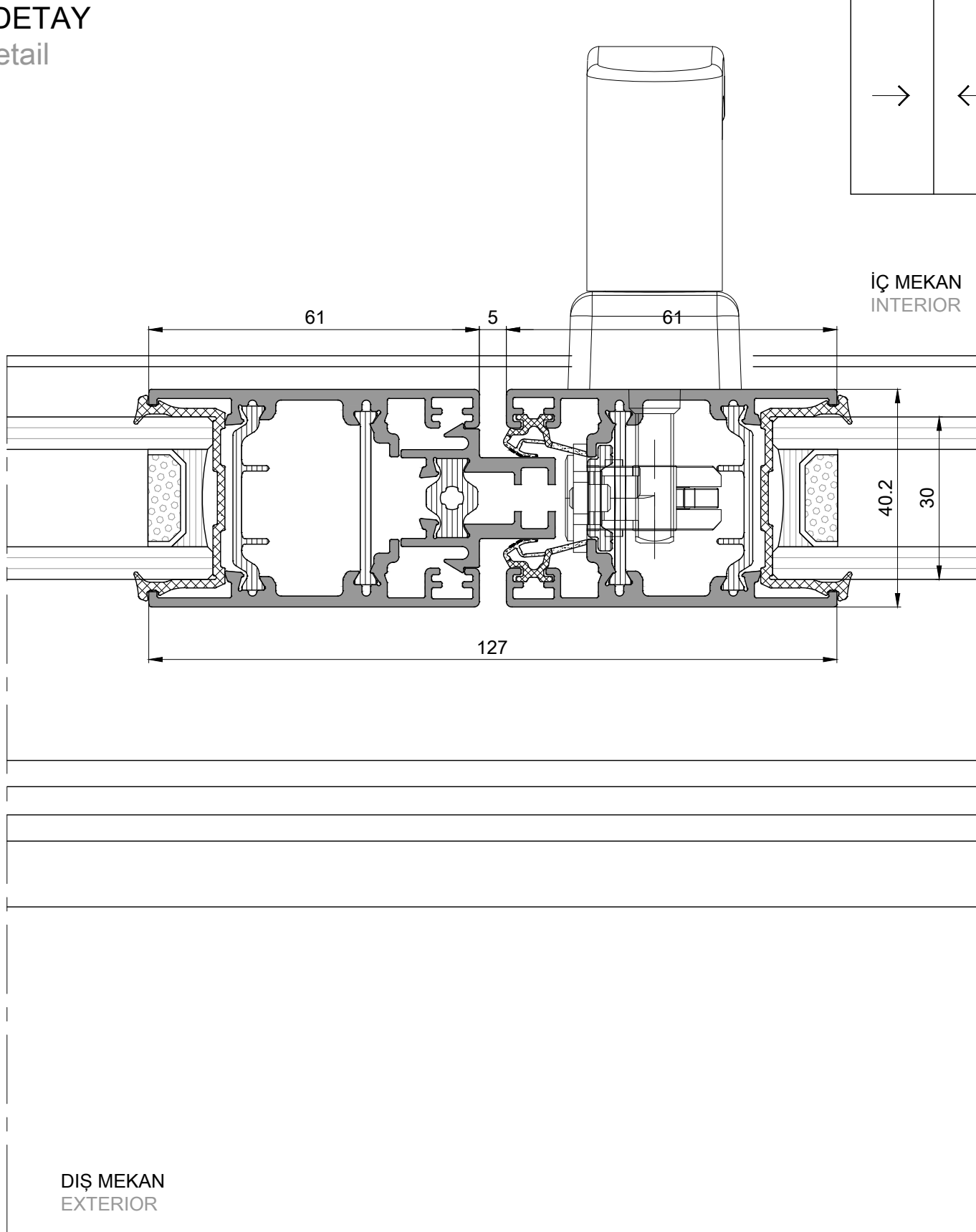

100mm YALITIMLI SAG YAN DETAY
100mm isolation with right side detail

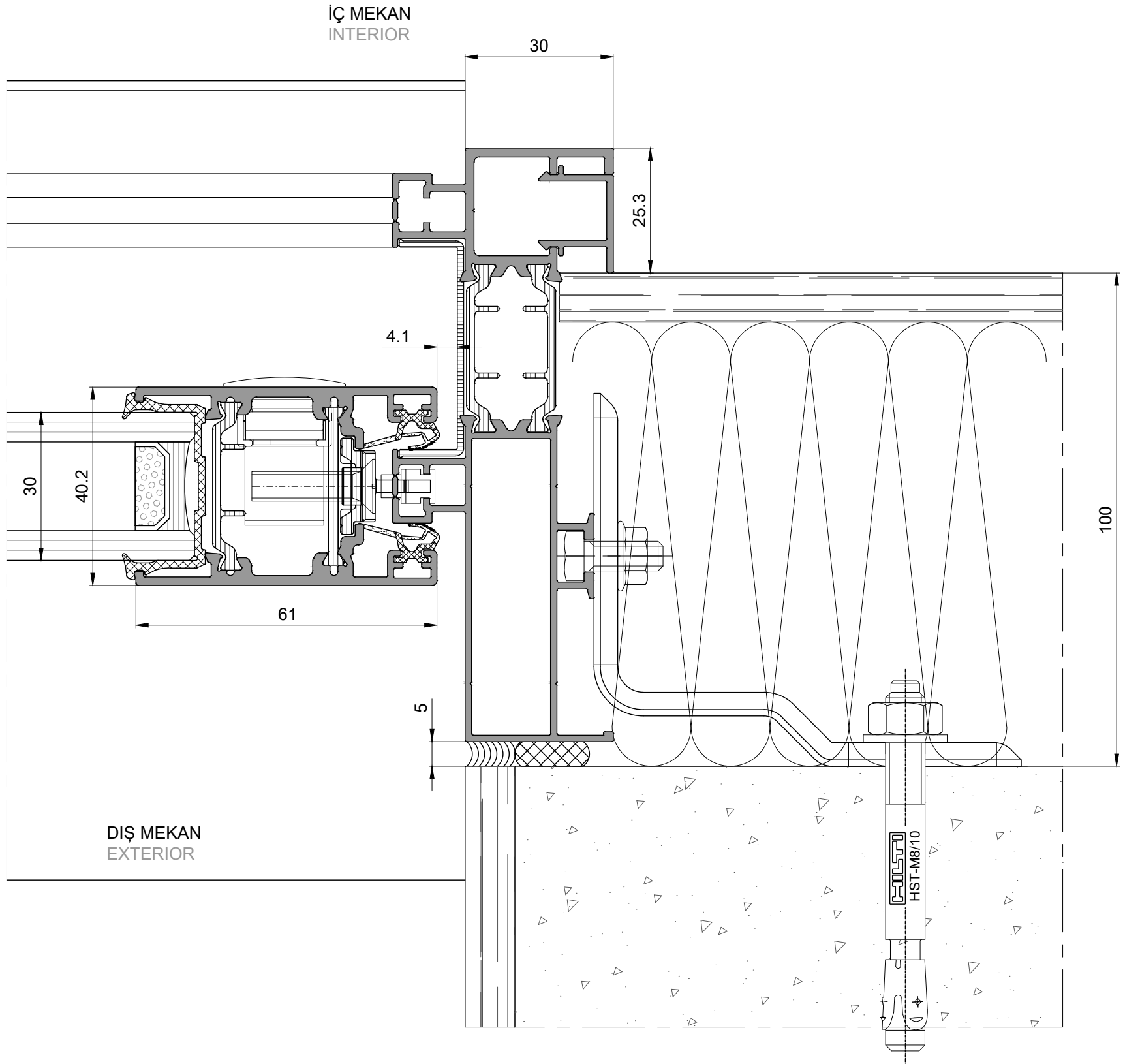
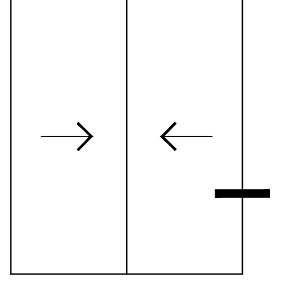

120mm YALITIMLI SAG YAN DETAY
120mm isolation with right side detail

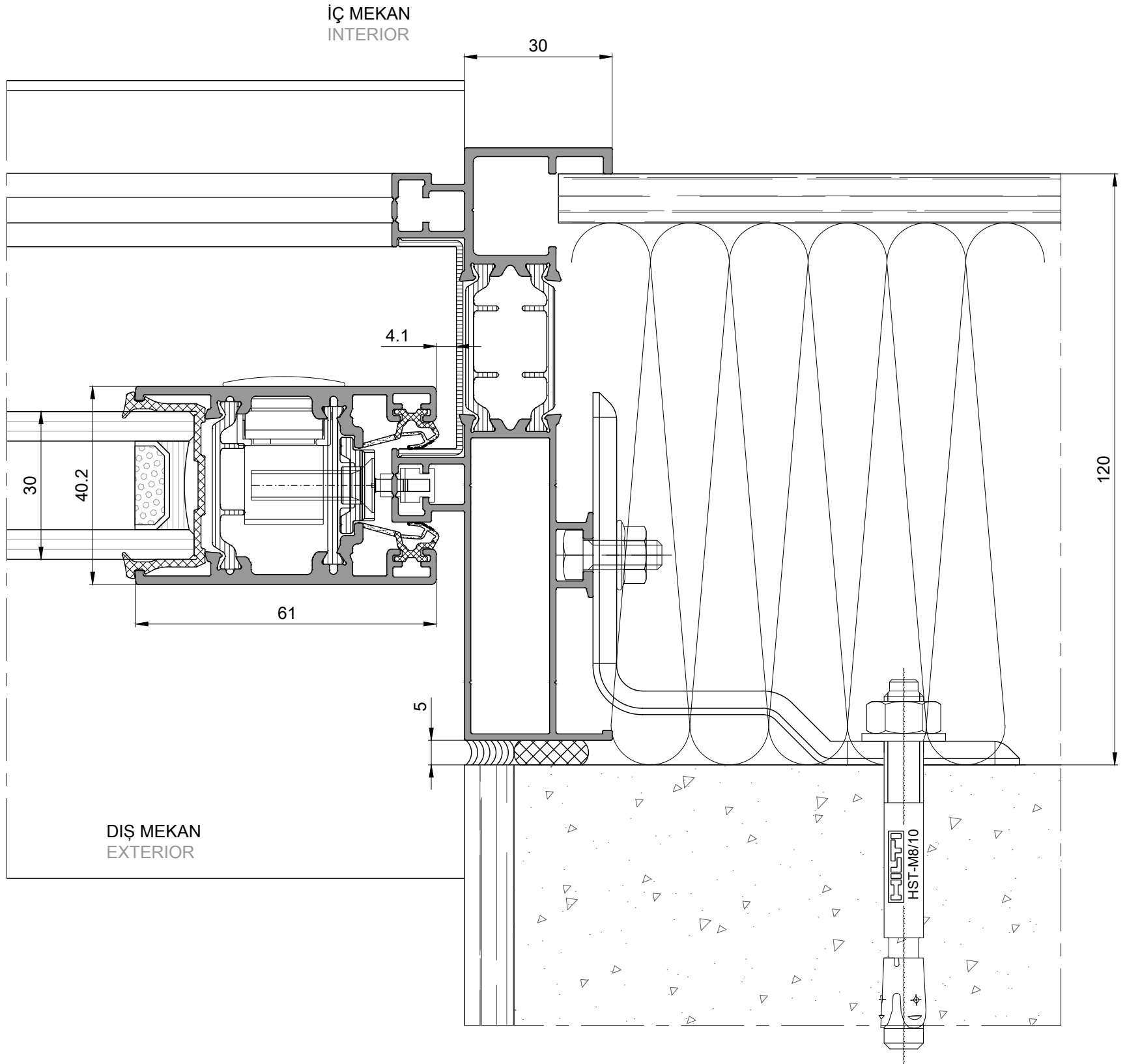
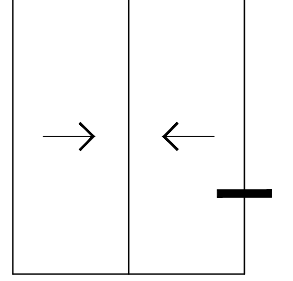

140mm YALITIMLI SAG YAN DETAY
140mm isolation with right side detail

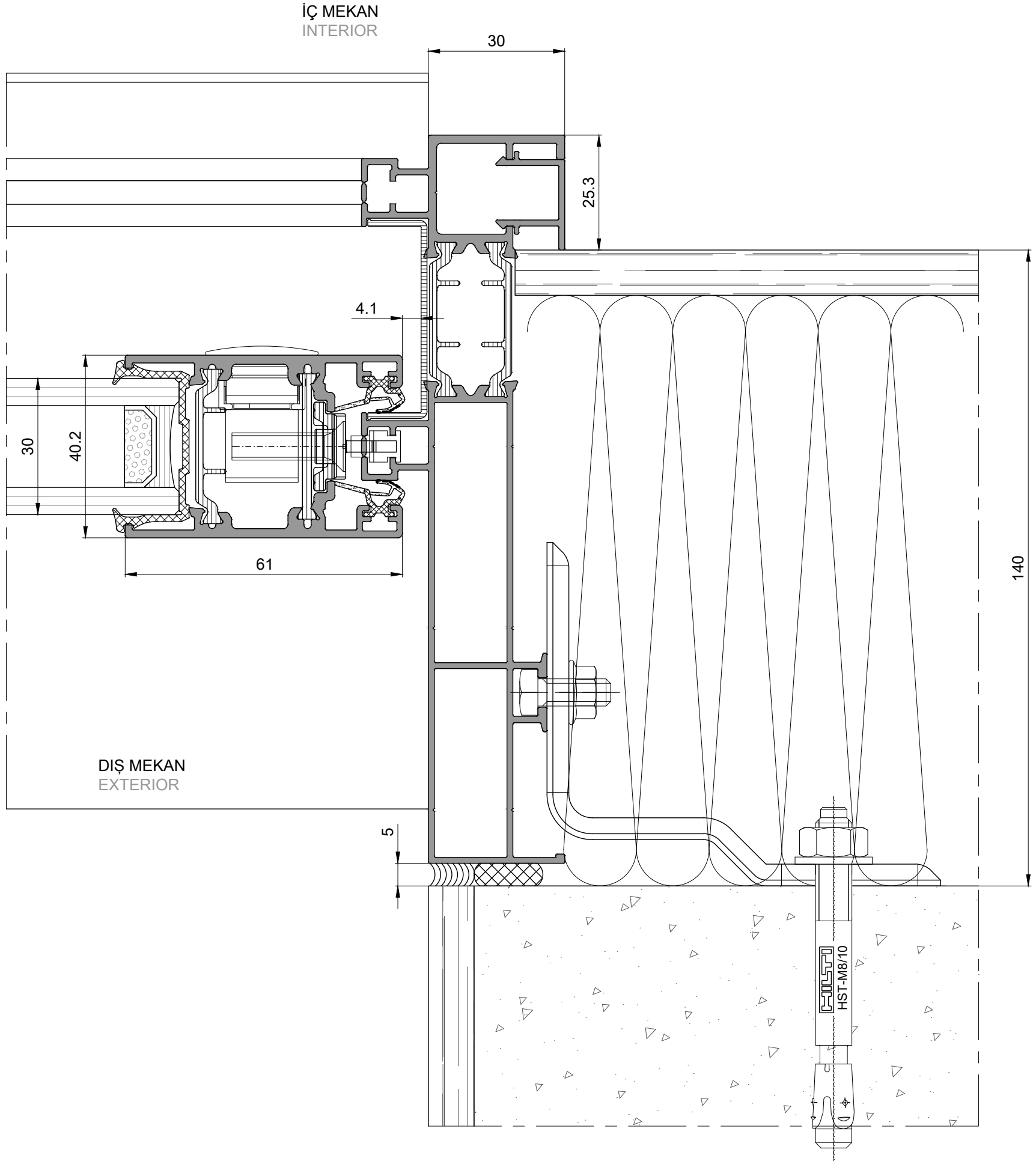
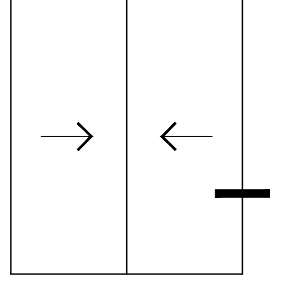

180mm YALITIMLI SAG YAN DETAY
180mm isolation with right side detail

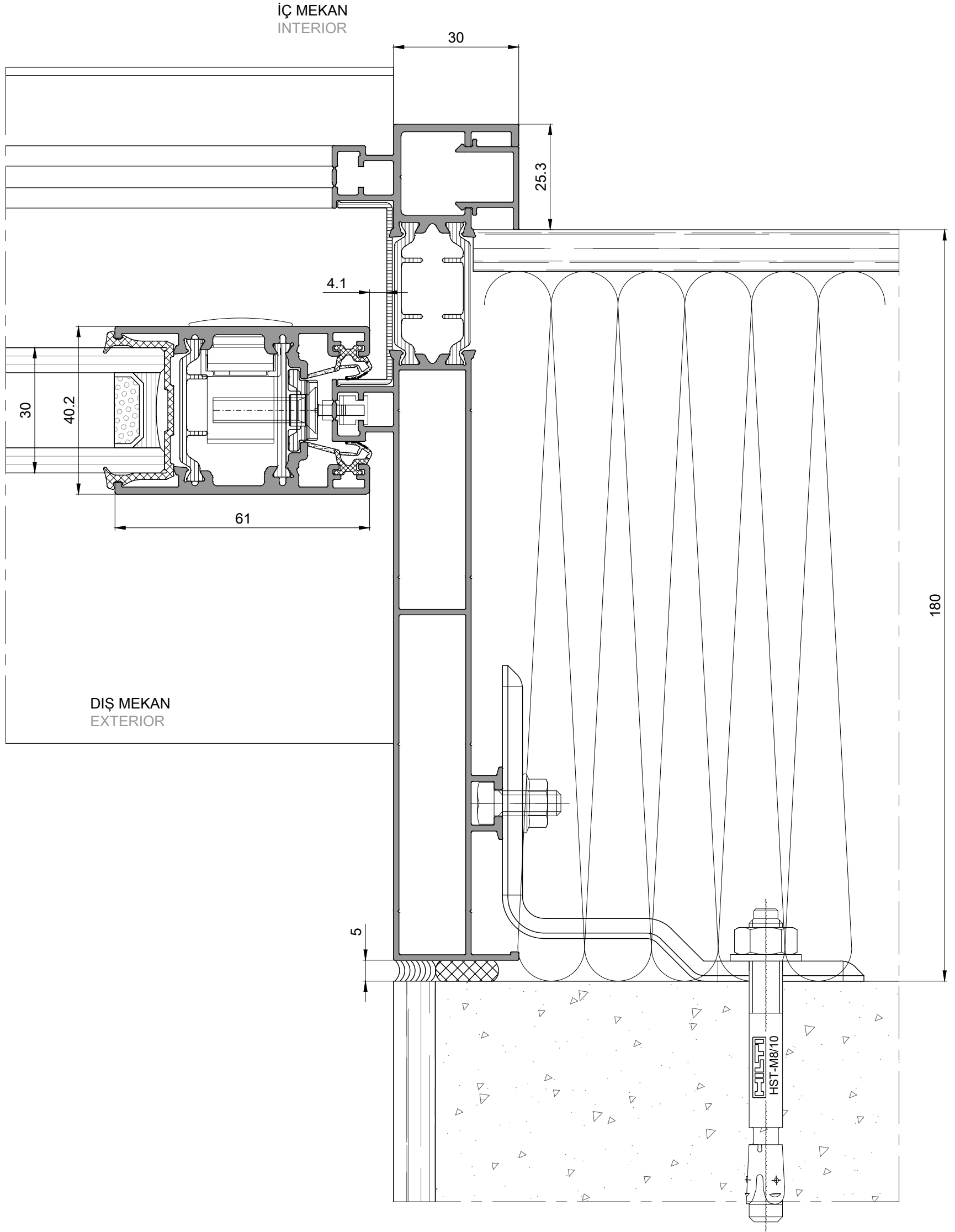
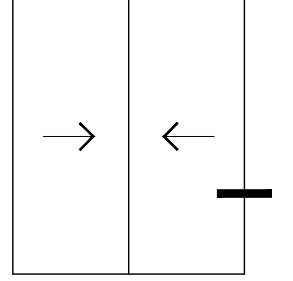

200mm YALITIMLI SAG YAN DETAY
200mm isolation with right side detail

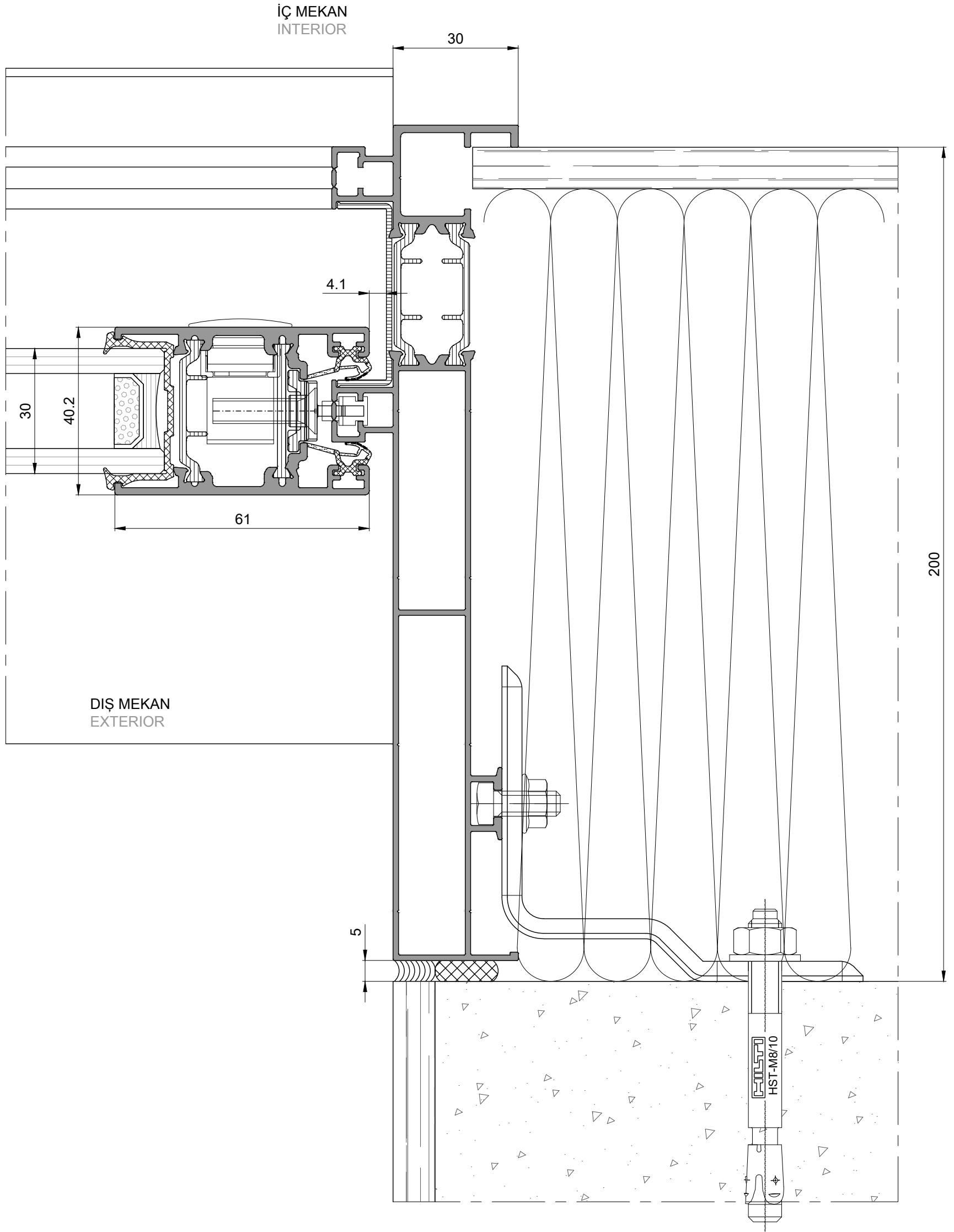
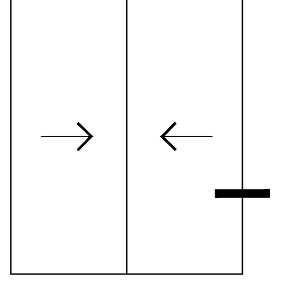

100mm YALITIMLI ÜST-İÇ KANAT DETAY
100mm isolation with top side inner sash detail

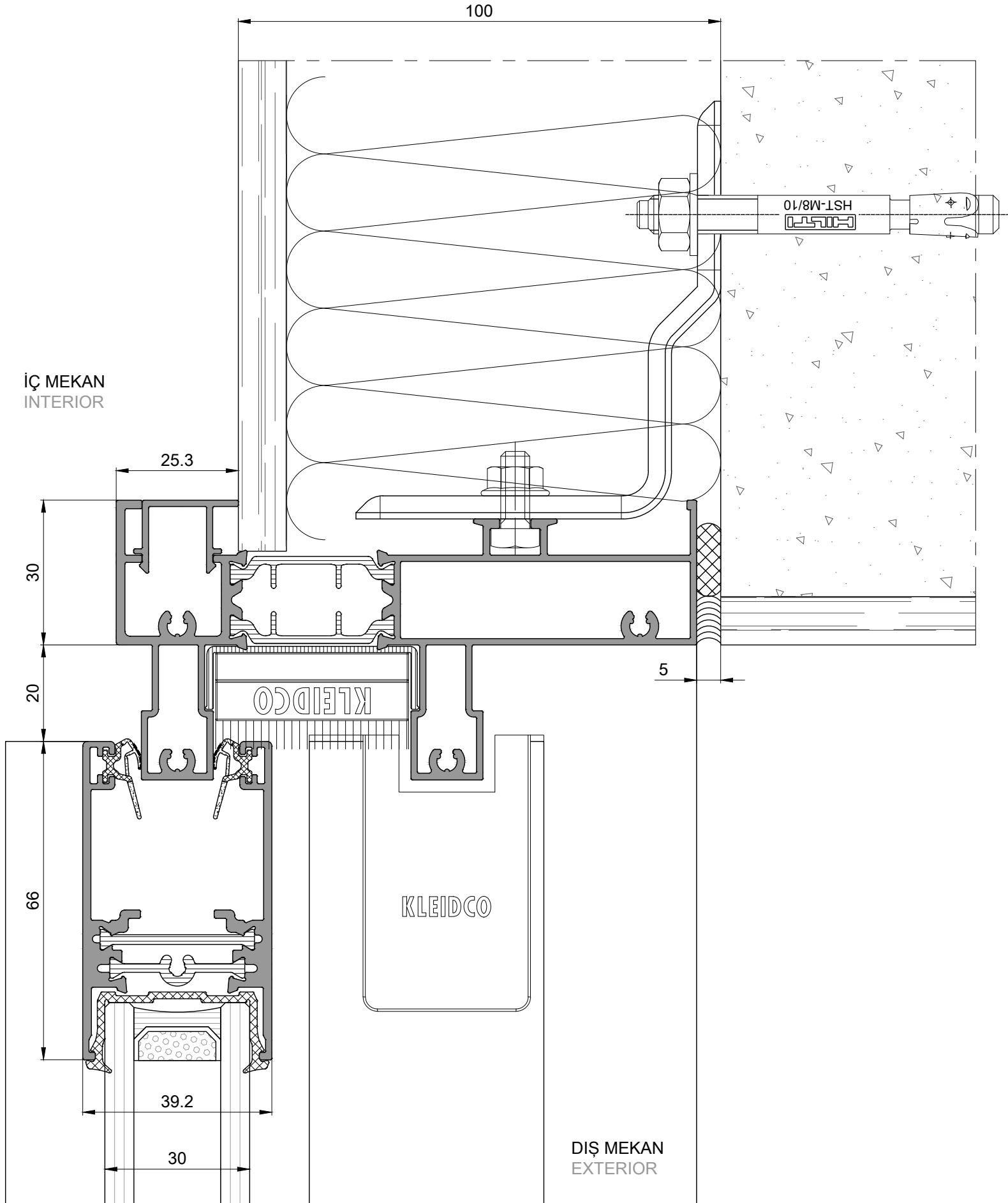
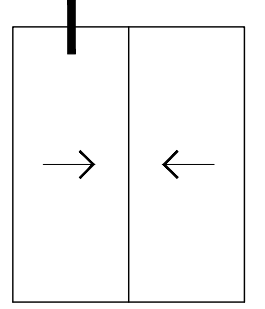

100mm YALITIMLI ÜST-DIŞ KANAT DETAY
100mm isolation with top side outer sash detail

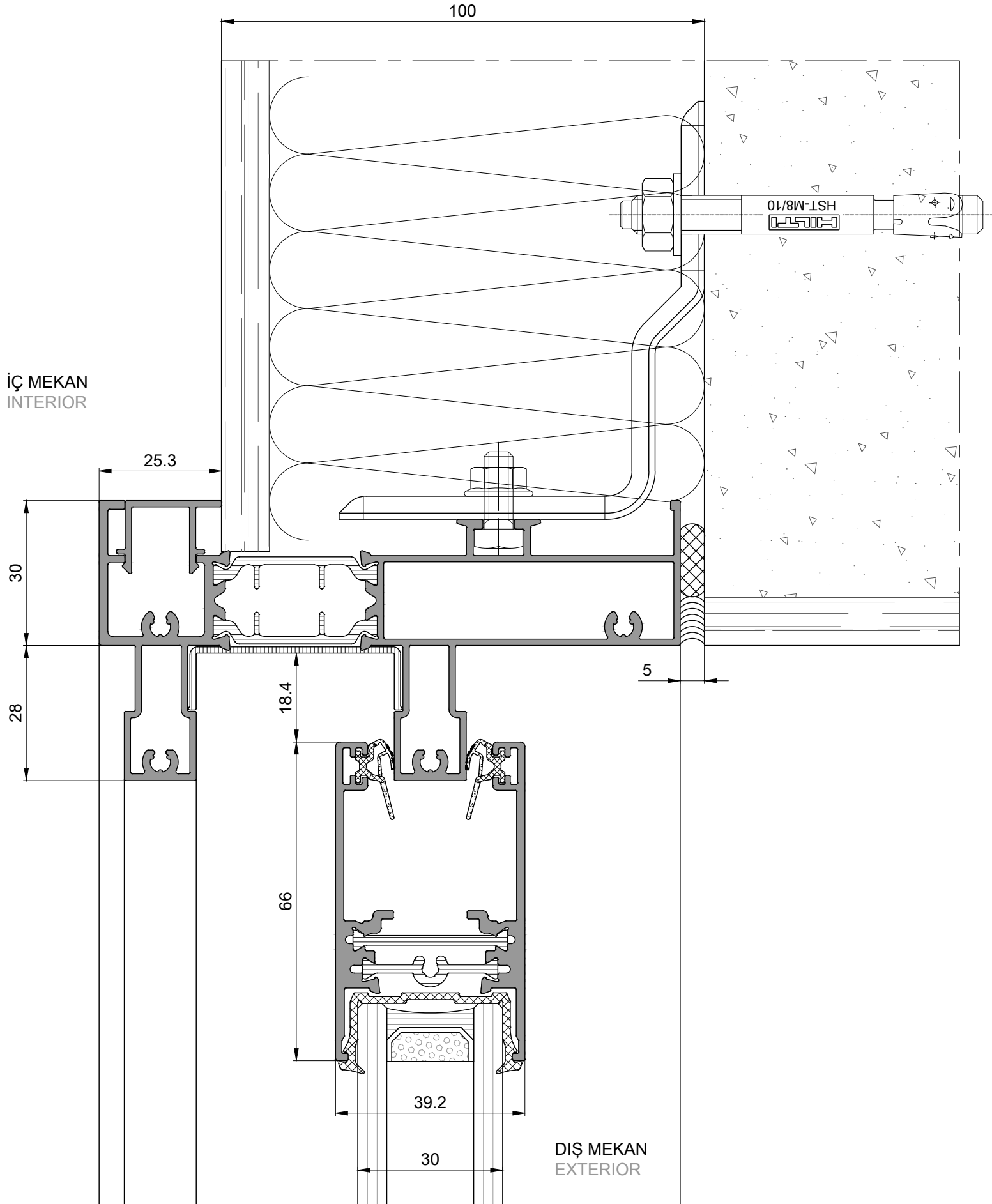
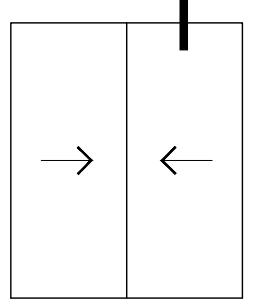

120mm YALITIMLI ÜST-İÇ KANAT DETAY
120mm isolation with top side inner sash detail

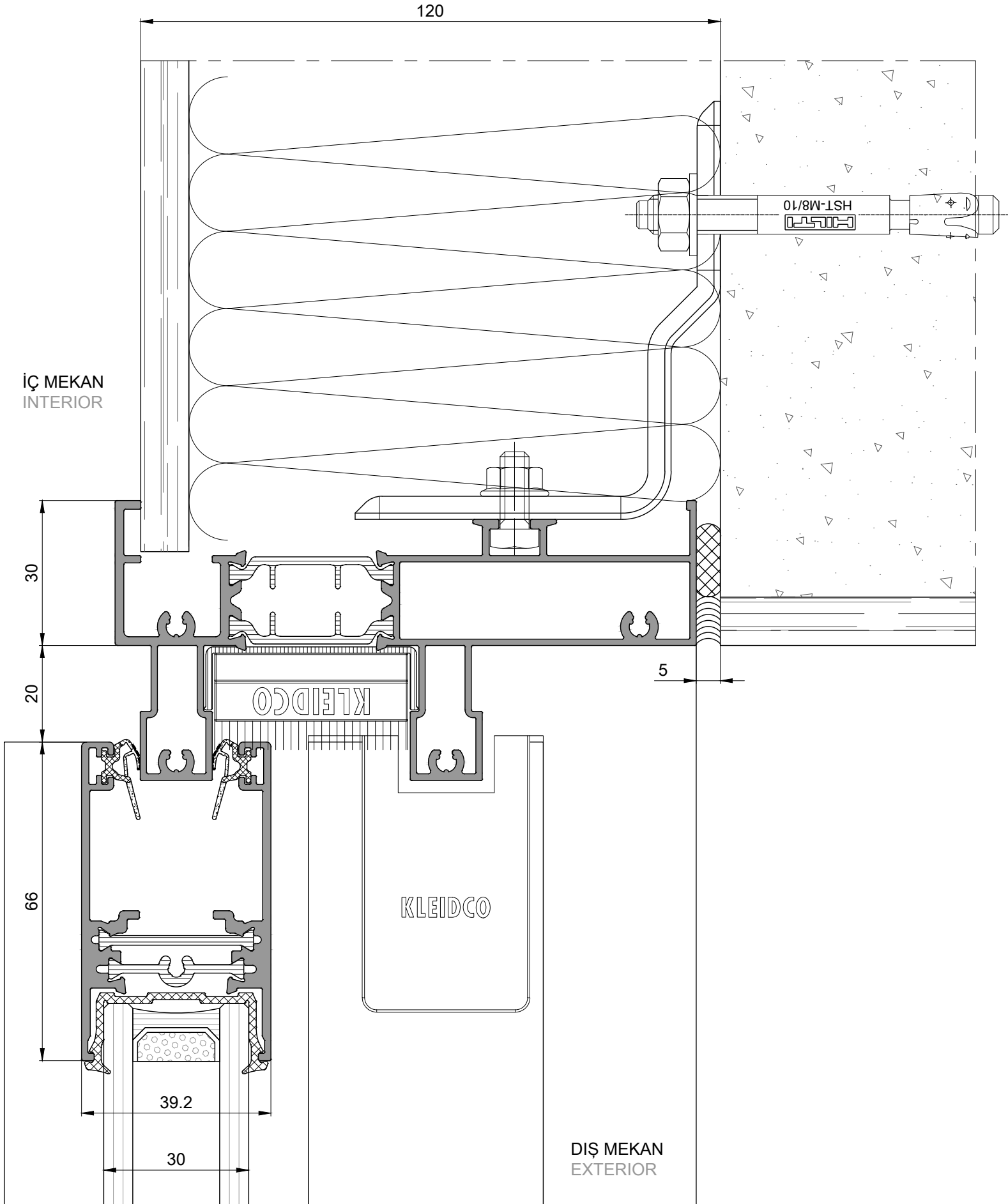
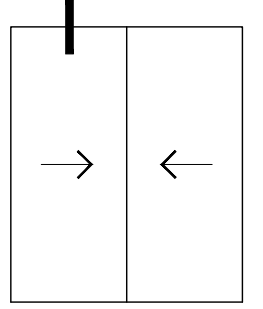

120mm YALITIMLI ÜST-DIŞ KANAT DETAY
120mm isolation with top side outer sash detail

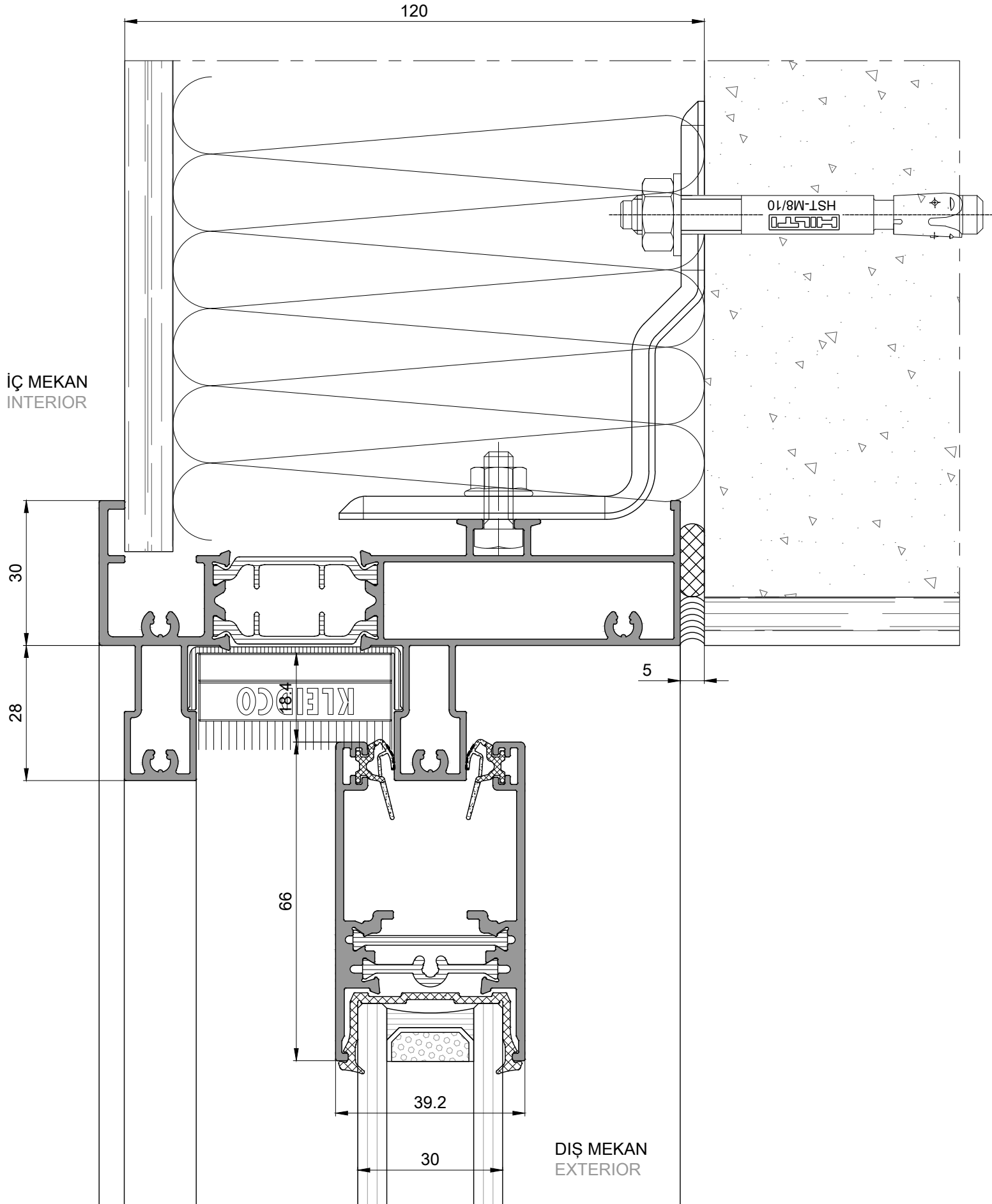
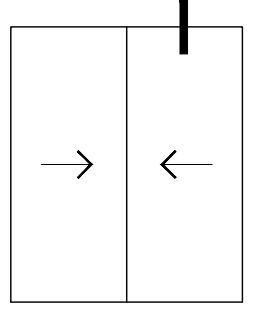

140mm YALITIMLI ÜST-İÇ KANAT DETAY
140mm isolation with top side inner sash detail

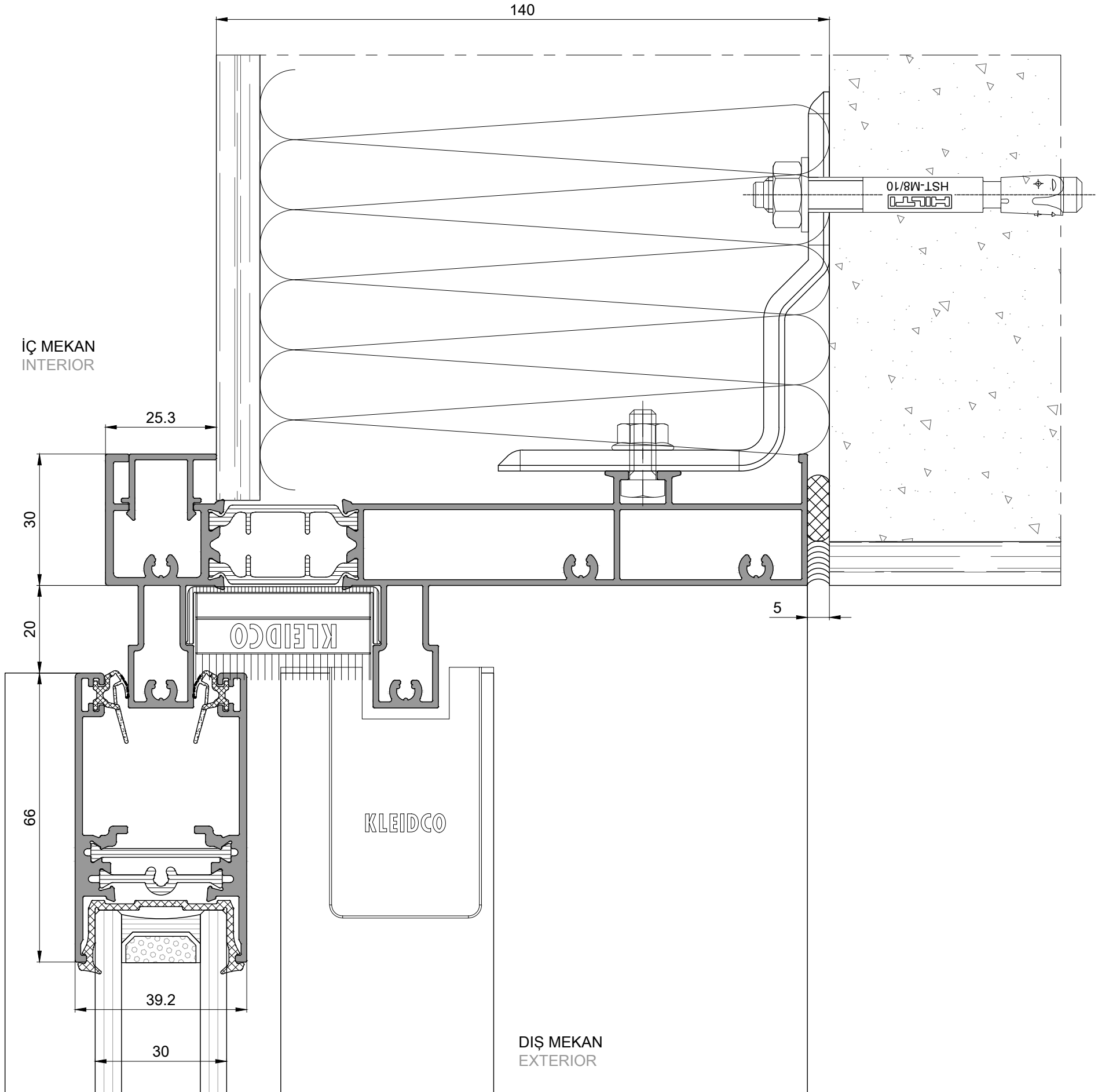
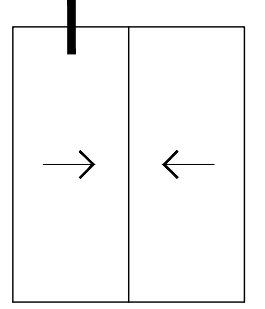

140mm YALITIMLI ÜST-DIŞ KANAT DETAY
140mm isolation with top side outer sash detail

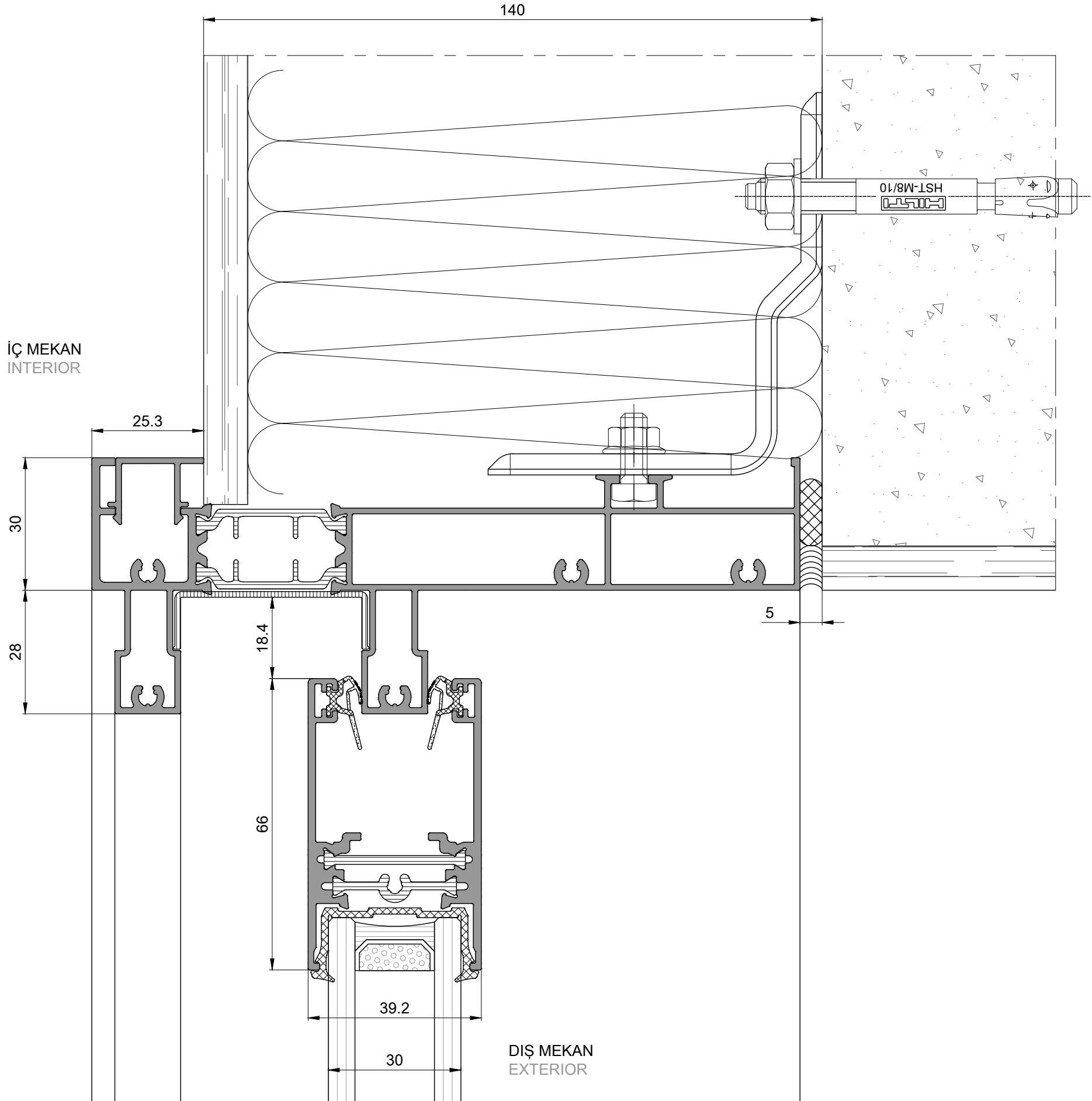
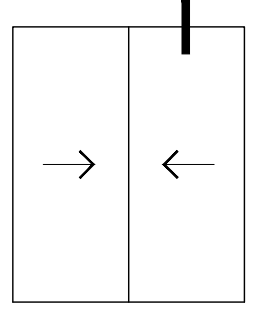

160mm YALITIMLI ÜST-İÇ KANAT DETAY
160mm isolation with top side inner sash detail

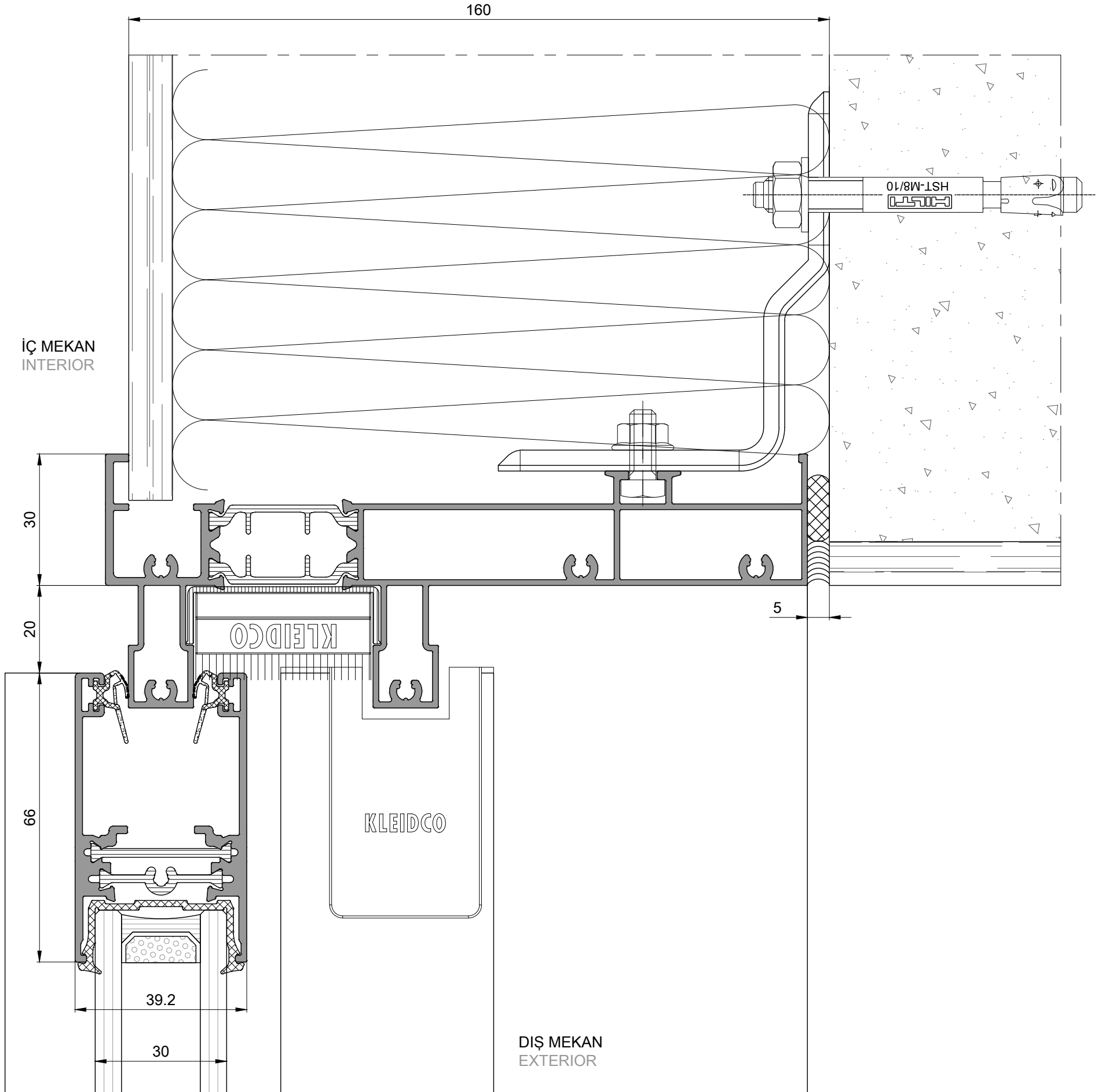
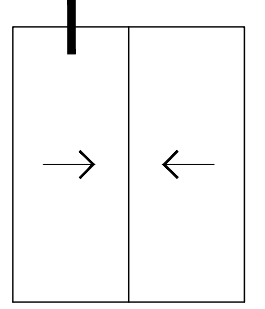

160mm YALITIMLI ÜST-DIŞ KANAT DETAY
160mm isolation with top side outer sash detail

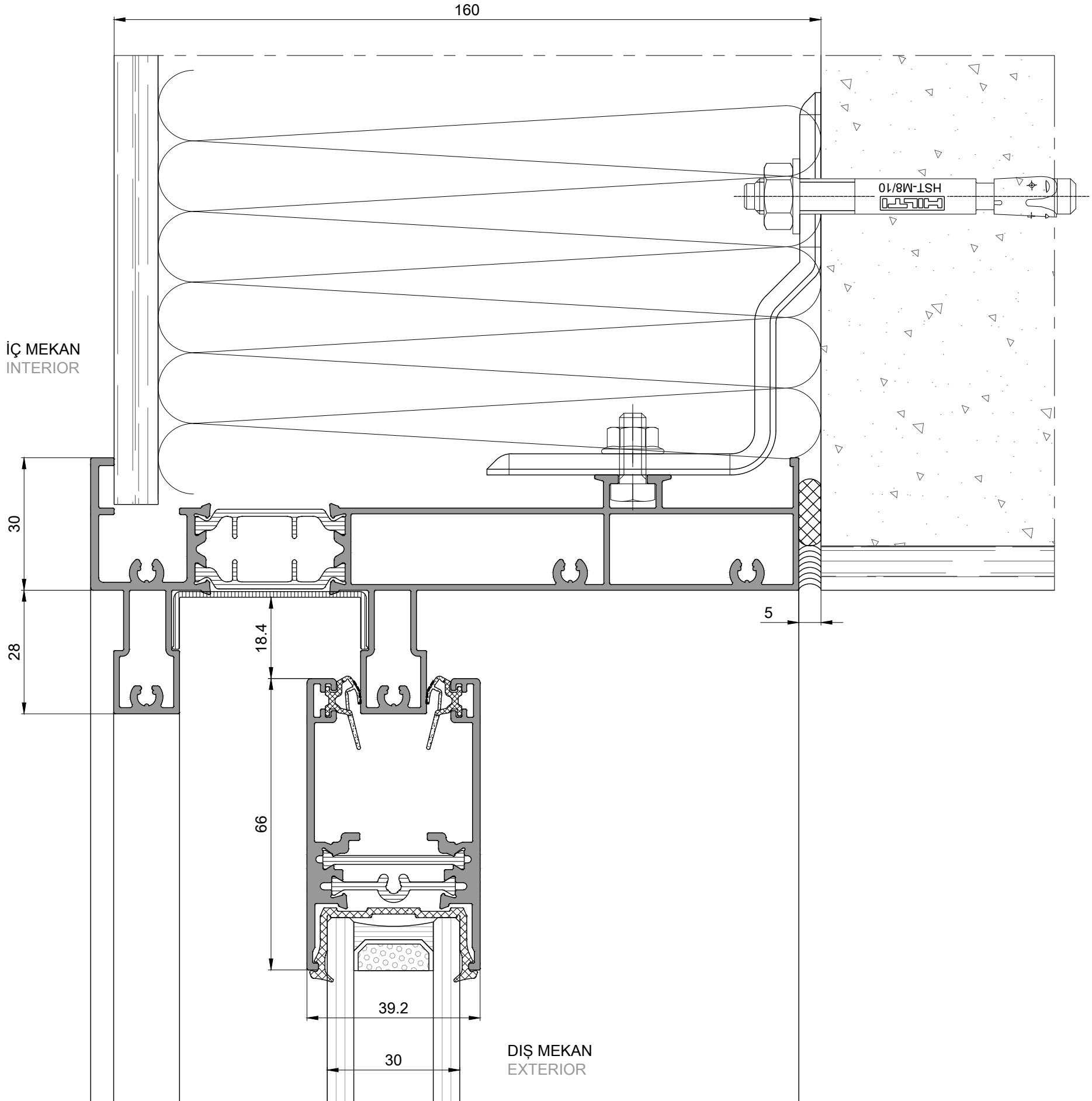
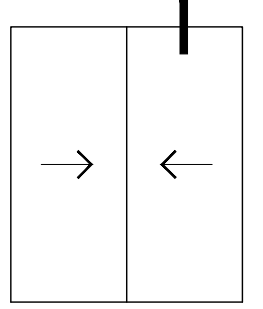

180mm YALITIMLI ÜST-İÇ KANAT DETAY
180mm isolation with top side inner sash detail

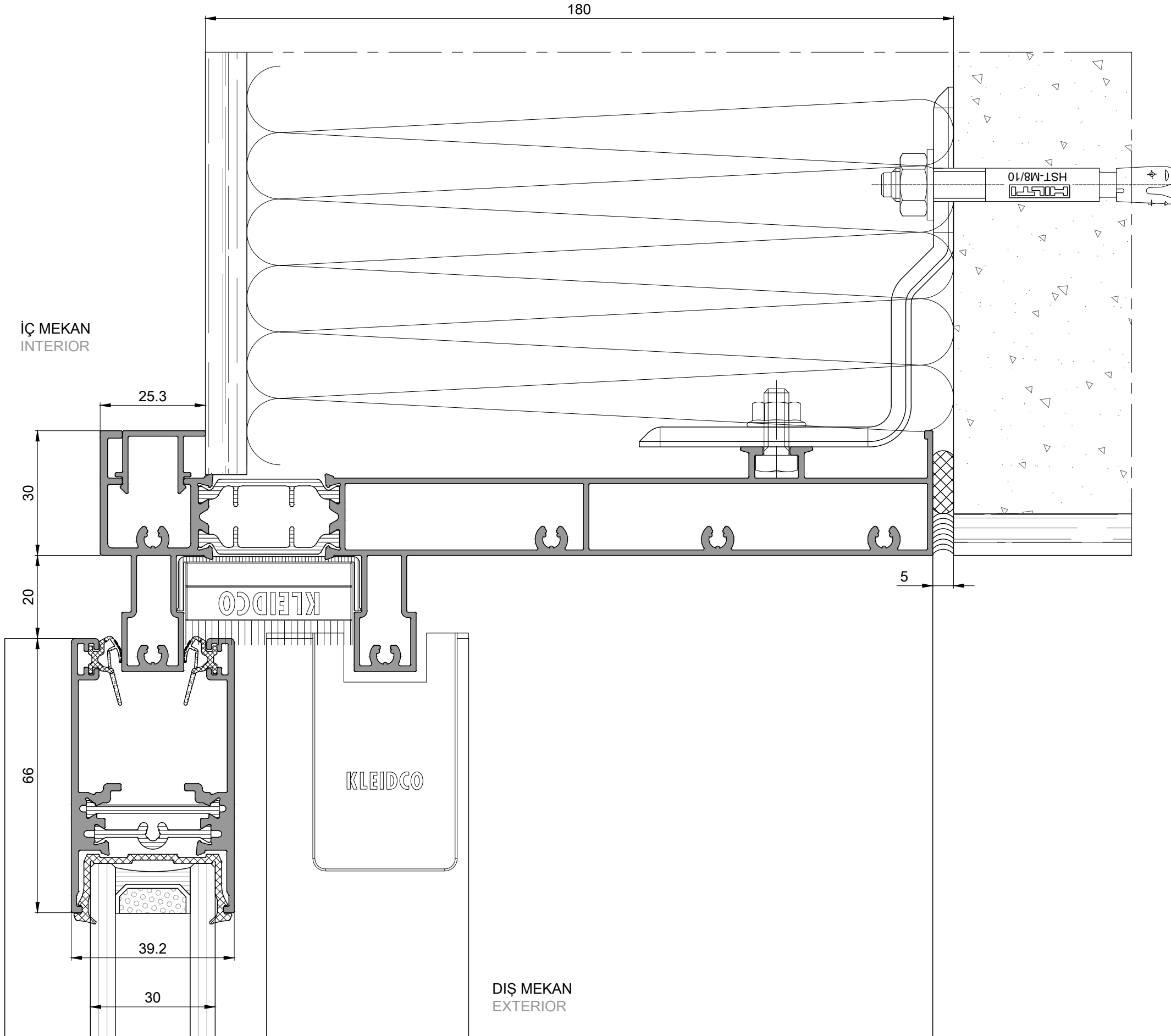
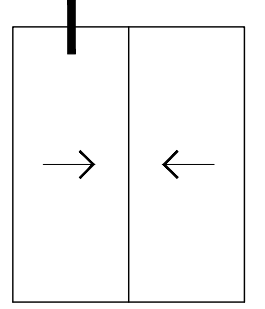

180mm YALITIMLI ÜST-DIŞ KANAT DETAY
180mm isolation with top side outer sash detail

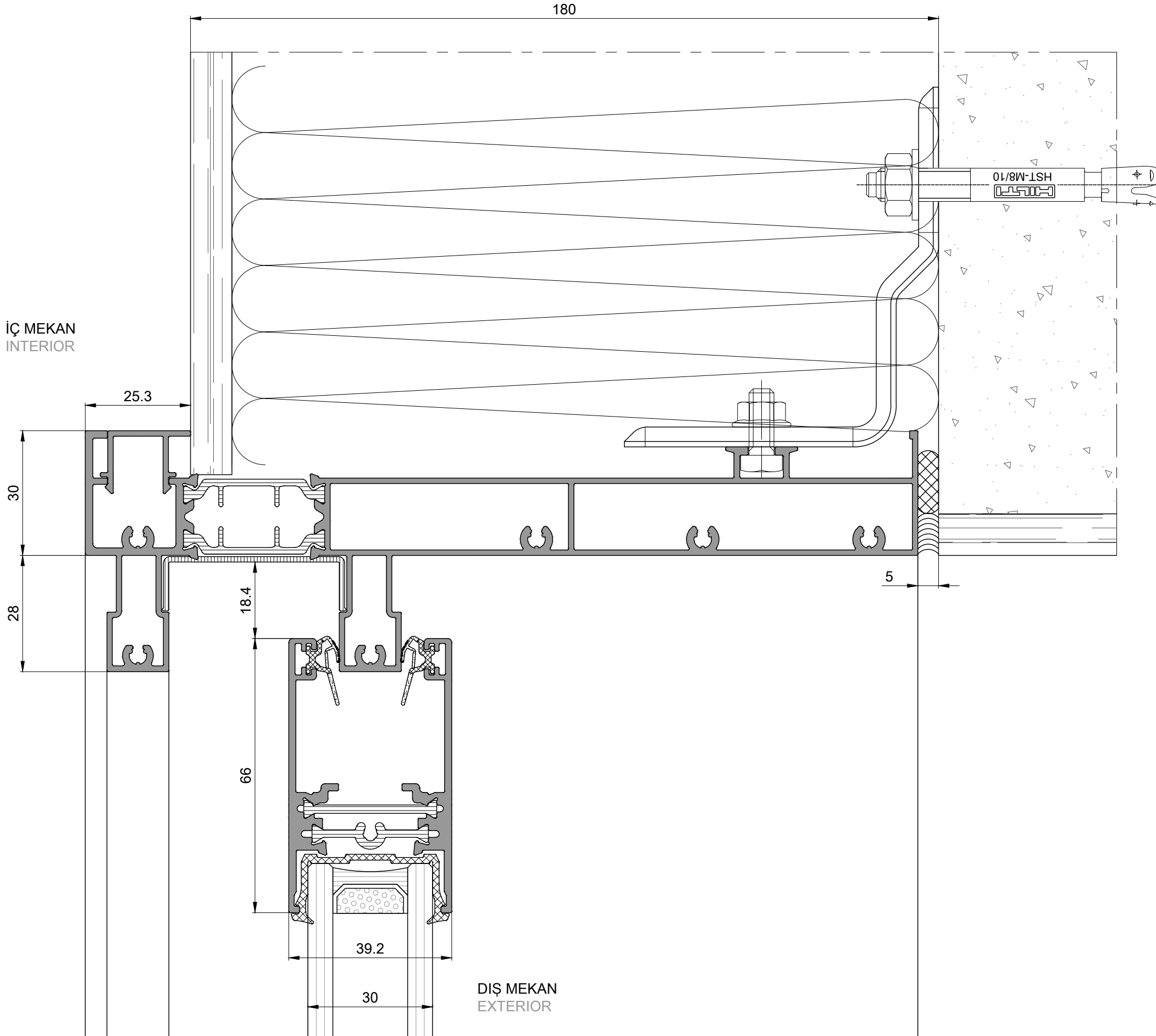
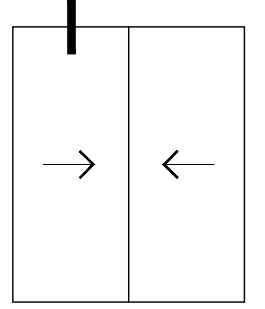

200mm YALITIMLI ÜST-İÇ KANAT DETAY
200mm isolation with top side inner sash detail

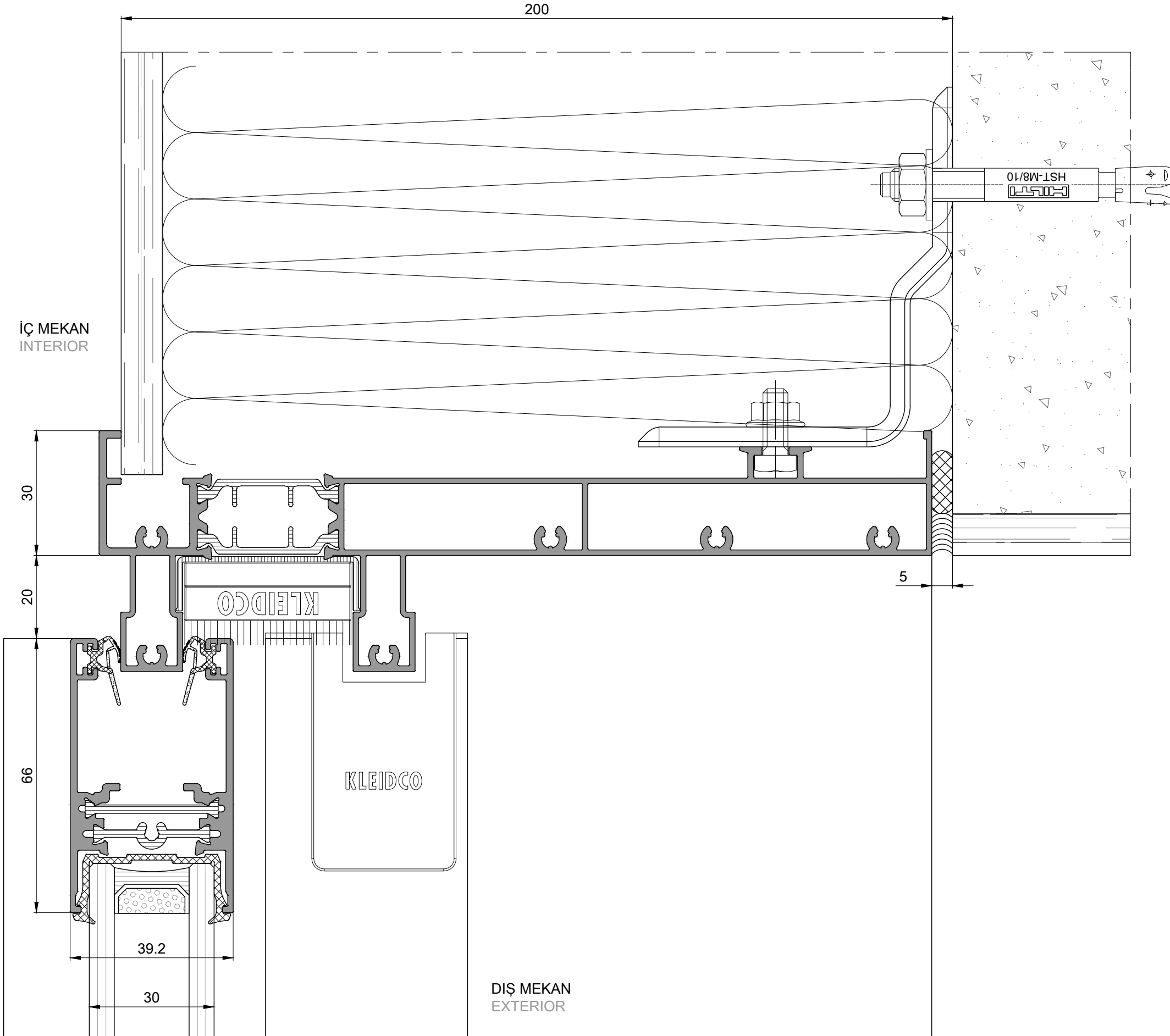
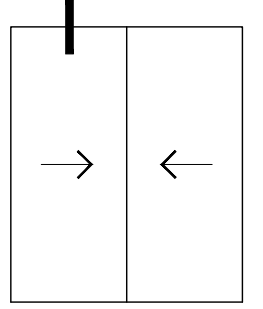

200mm YALITIMLI ÜST-DIŞ KANAT DETAY
200mm isolation with top side outer sash detail

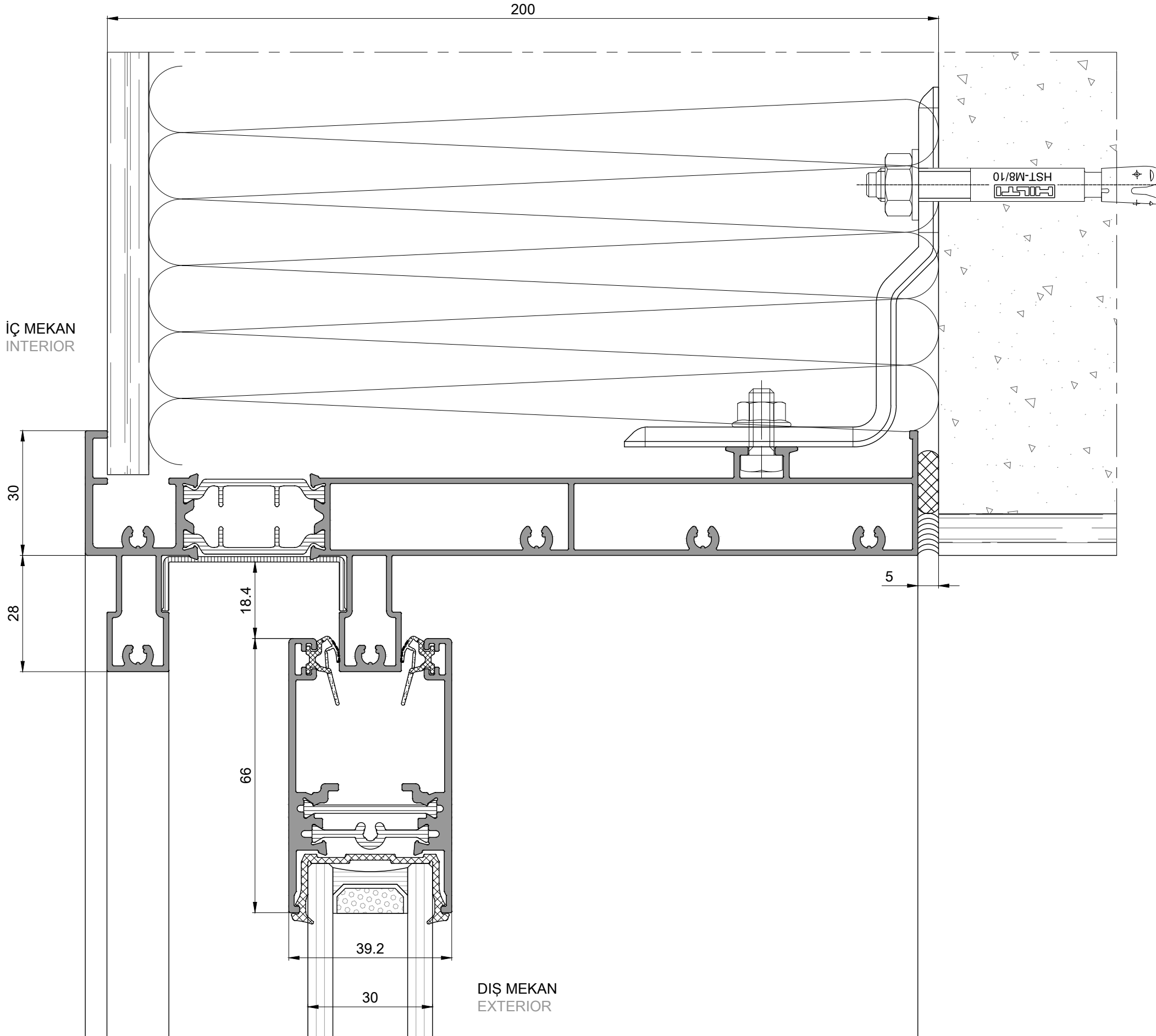
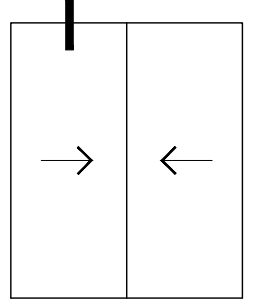

100-120-140mm YALITIMLI ALT-IÇ KANAT DETAY
100-120-140mm isolation with bottom side inner sash detail

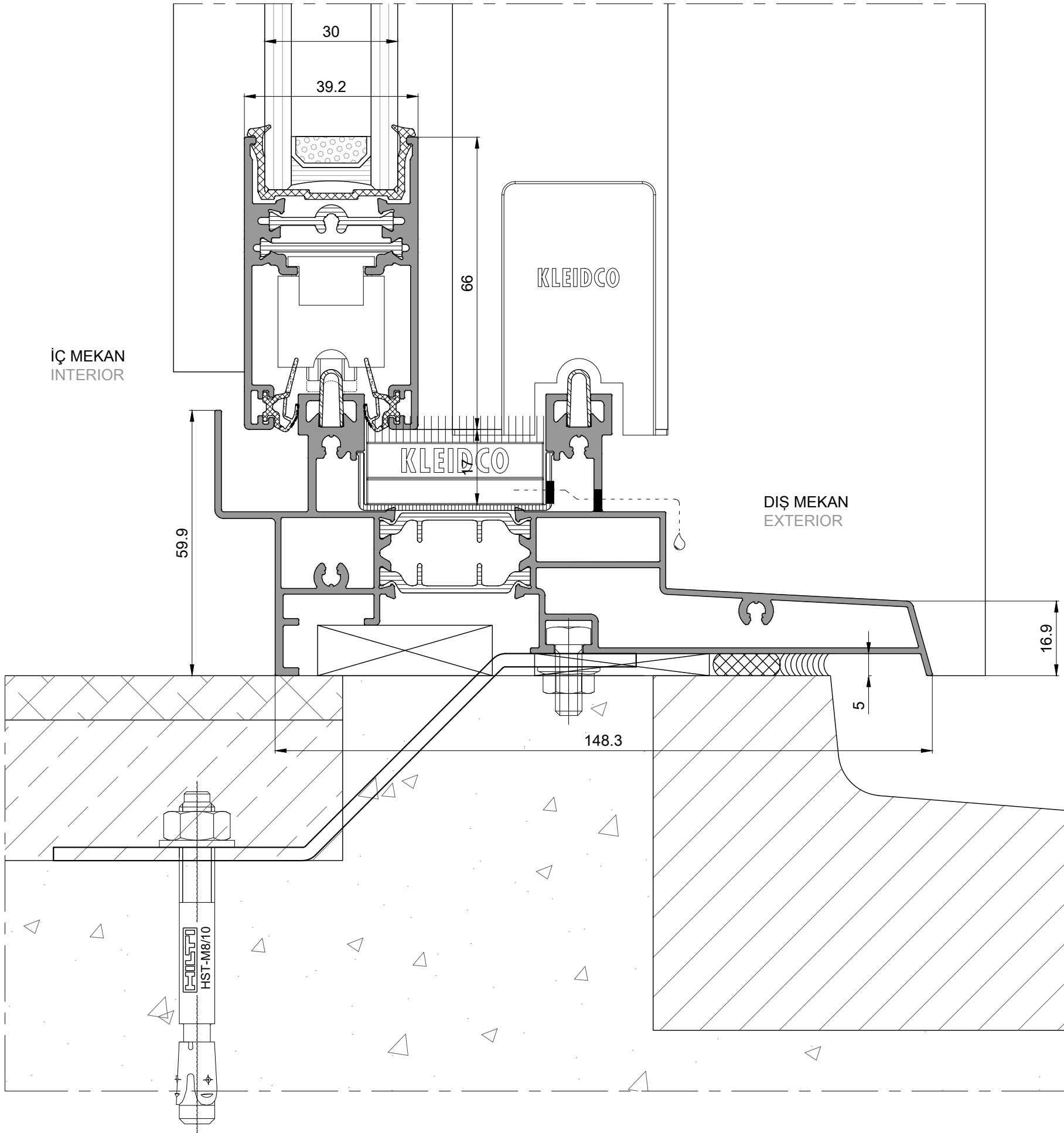
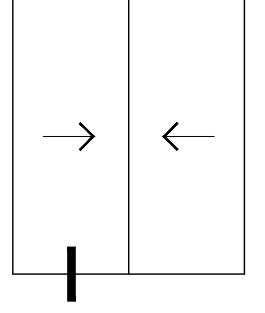

100-120-140mm YALITIMLI ALT-DIŞ KANAT DETAY
100-120-140mm isolation with bottom side outer sash detail

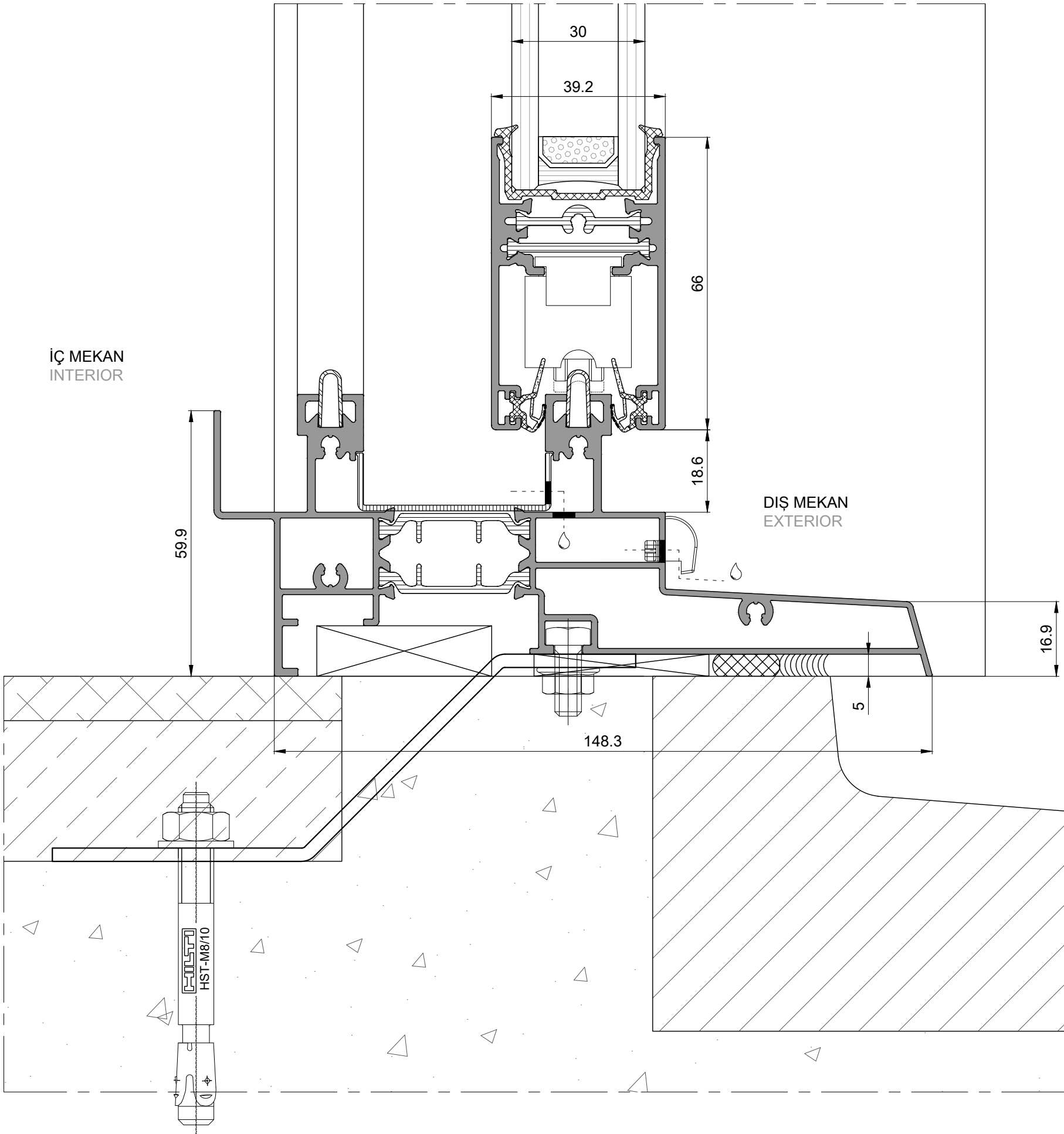
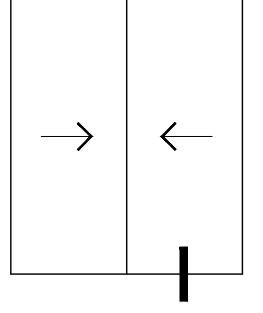

160-180-200mm YALITIMLI ALT-IÇ KANAT DETAY
160-180-200mm isolation with bottom side inner sash detail

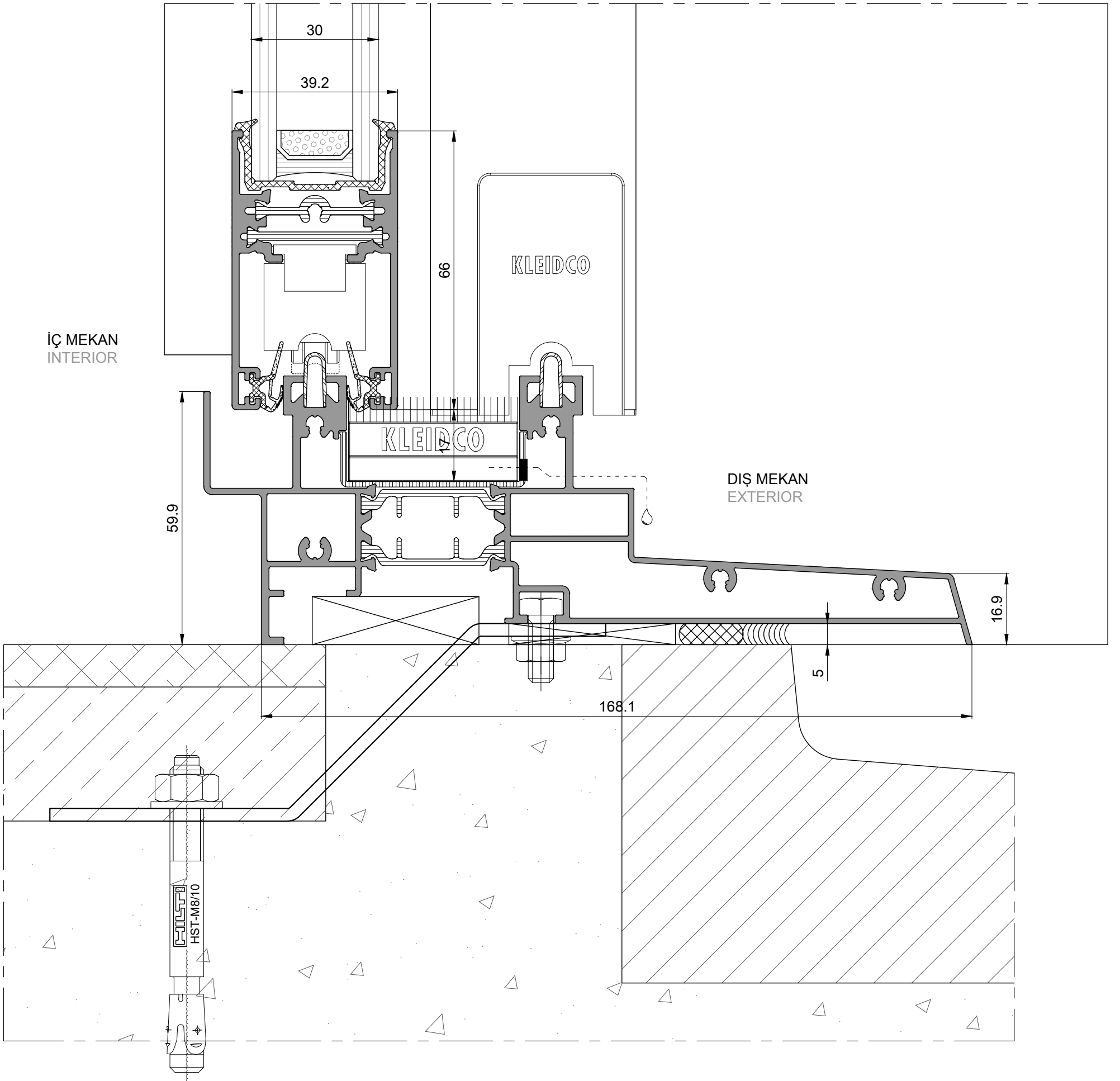
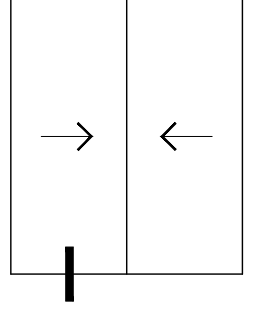

160-180-200mm YALITIMLI ALT-DIŞ KANAT DETAY
160-180-200mm isolation with bottom side outer sash detail

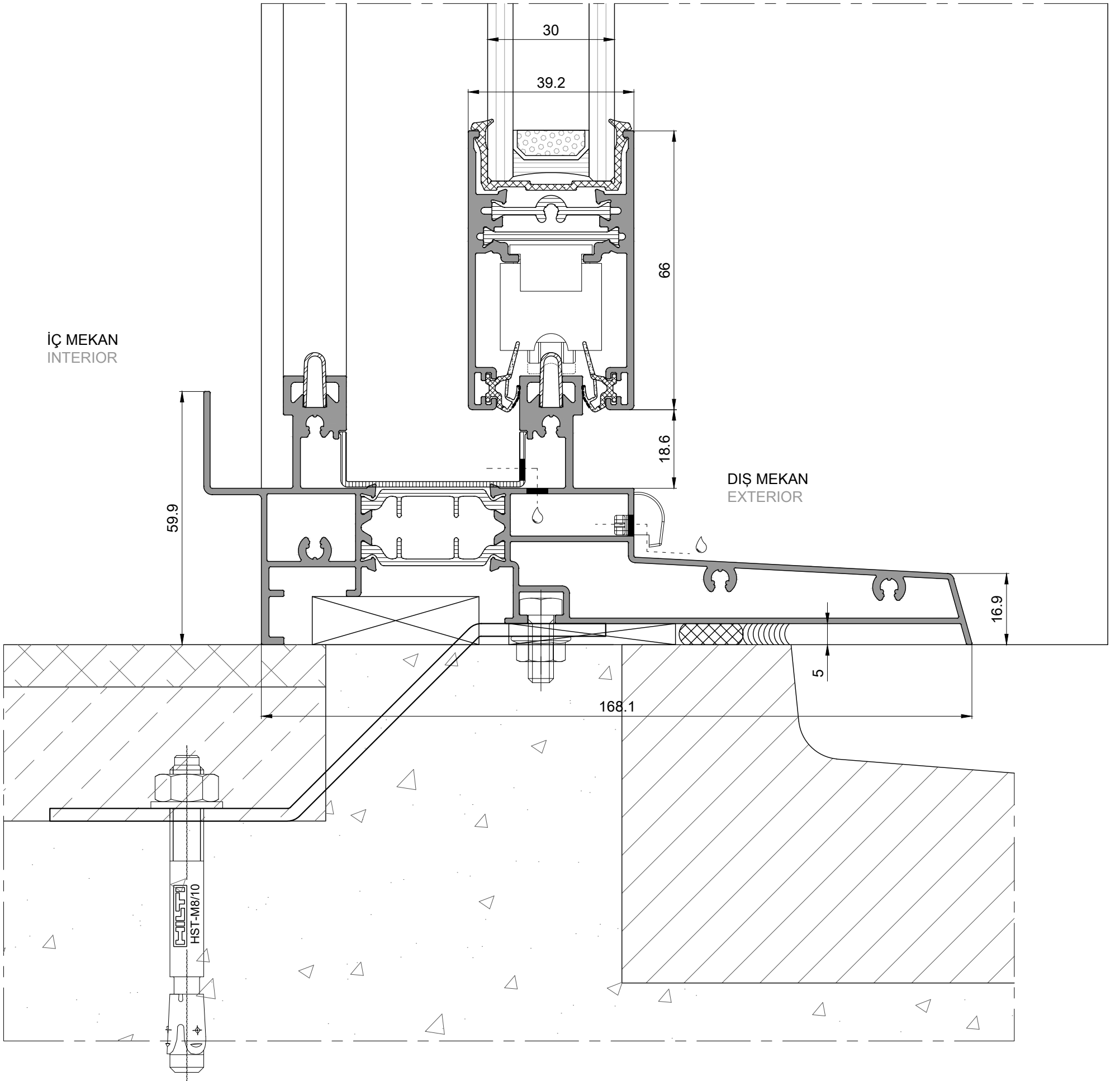
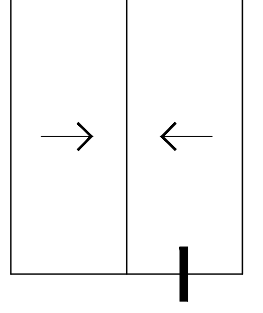

MOTIONslide
SÜRME KAPI ve PENCERE SİSTEMİ
SLIDING WINDOW and DOOR SYSTEM

3 RAYLI SÜRME
PRENSİP SİSTEM DETAYLARI
PRINCIPAL SECTIONS for
TRIPLE RAIL SLIDING SYSTEM

140mm YALITIMLI,3 RAYLI KASA İLE SOL YAN DETAY
140mm isolation, triple rail frame with left side detail

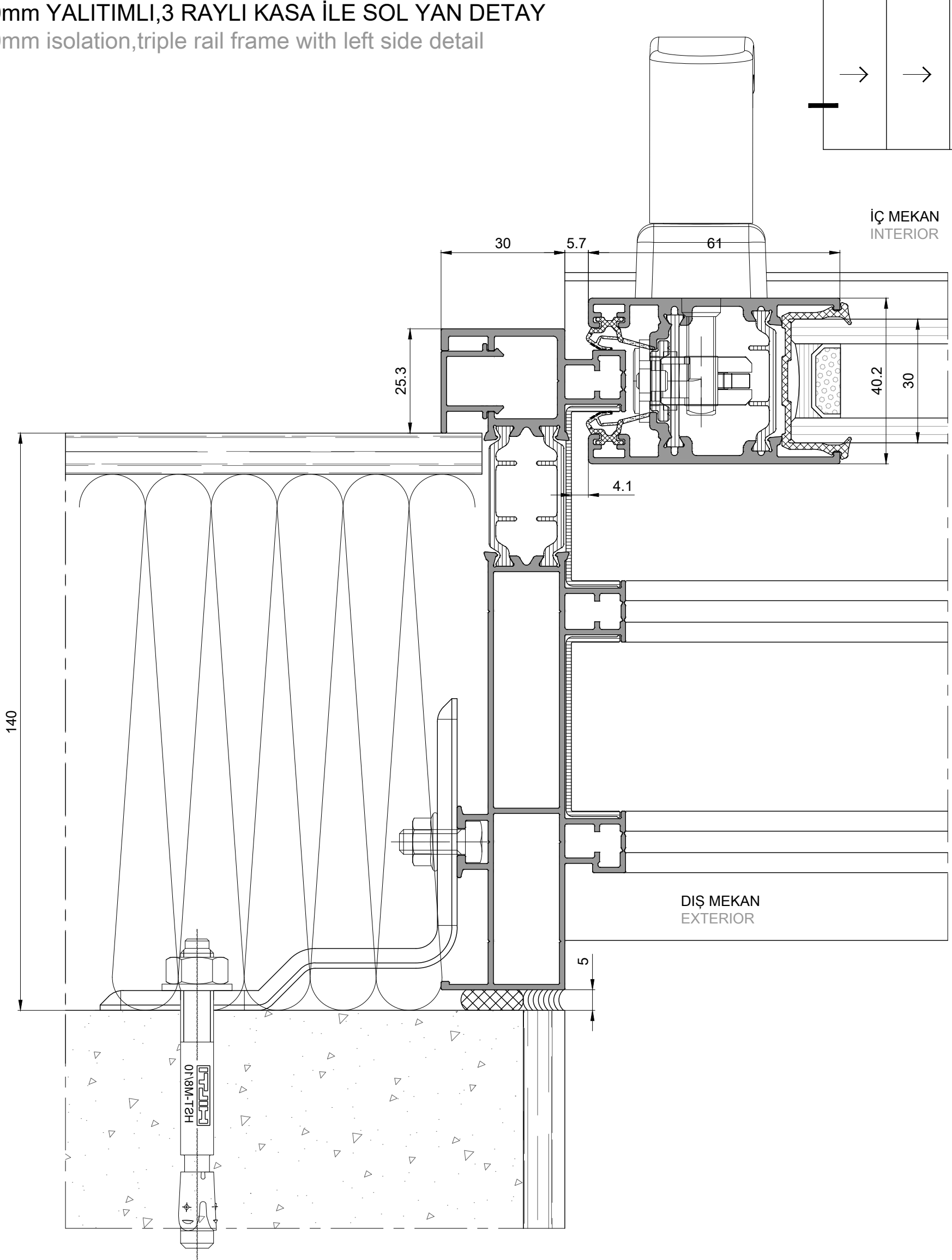

160mm YALITIMLI,3 RAYLI KASA İLE SOL YAN DETAY
160mm isolation, triple rail frame with left side detail

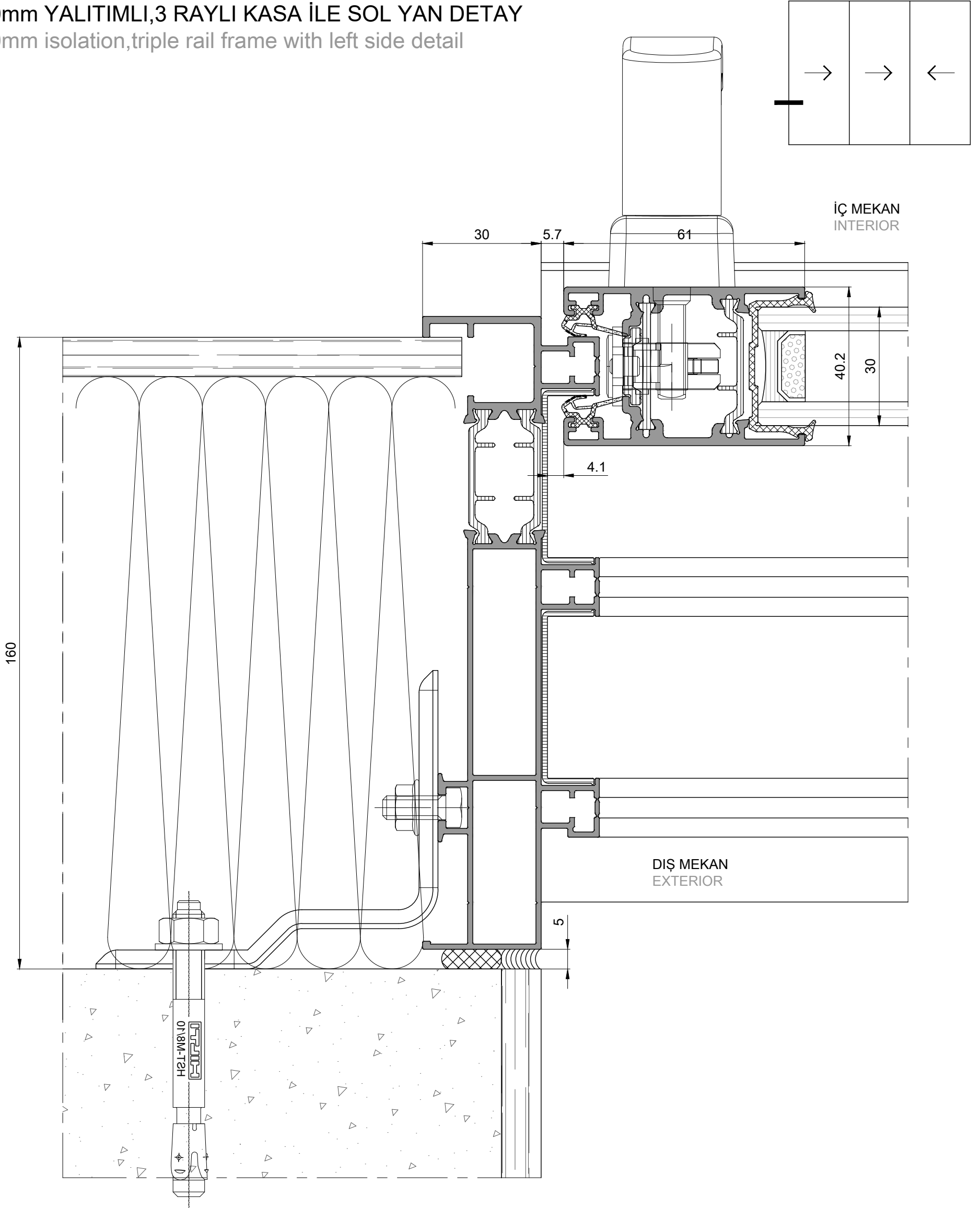

180mm YALITIMLI,3 RAYLI KASA İLE SOL YAN DETAY
180mm isolation, triple rail frame with left side detail

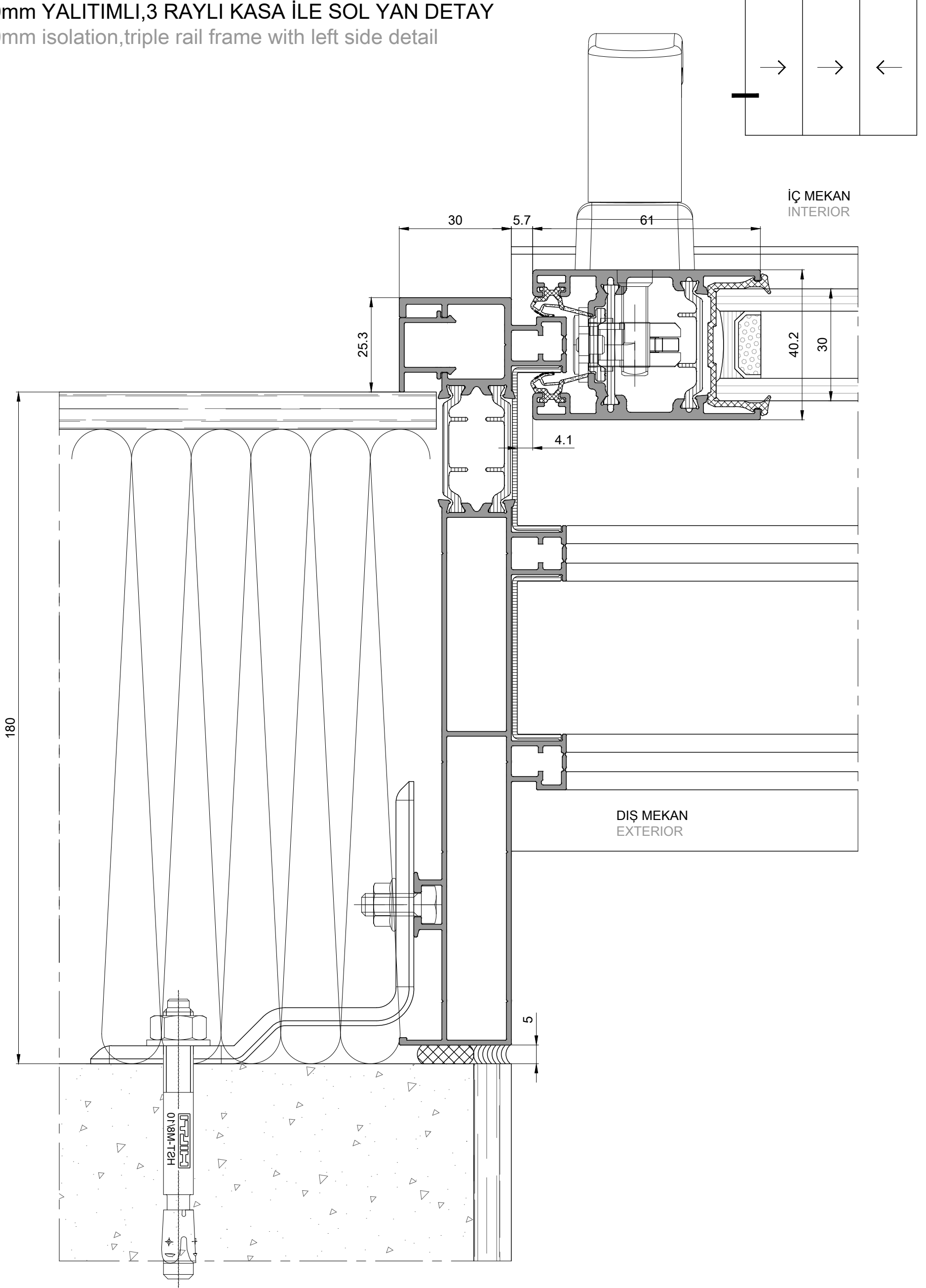

200mm YALITIMLI,3 RAYLI KASA İLE SOL YAN DETAY
200mm isolation, triple rail frame with left side detail

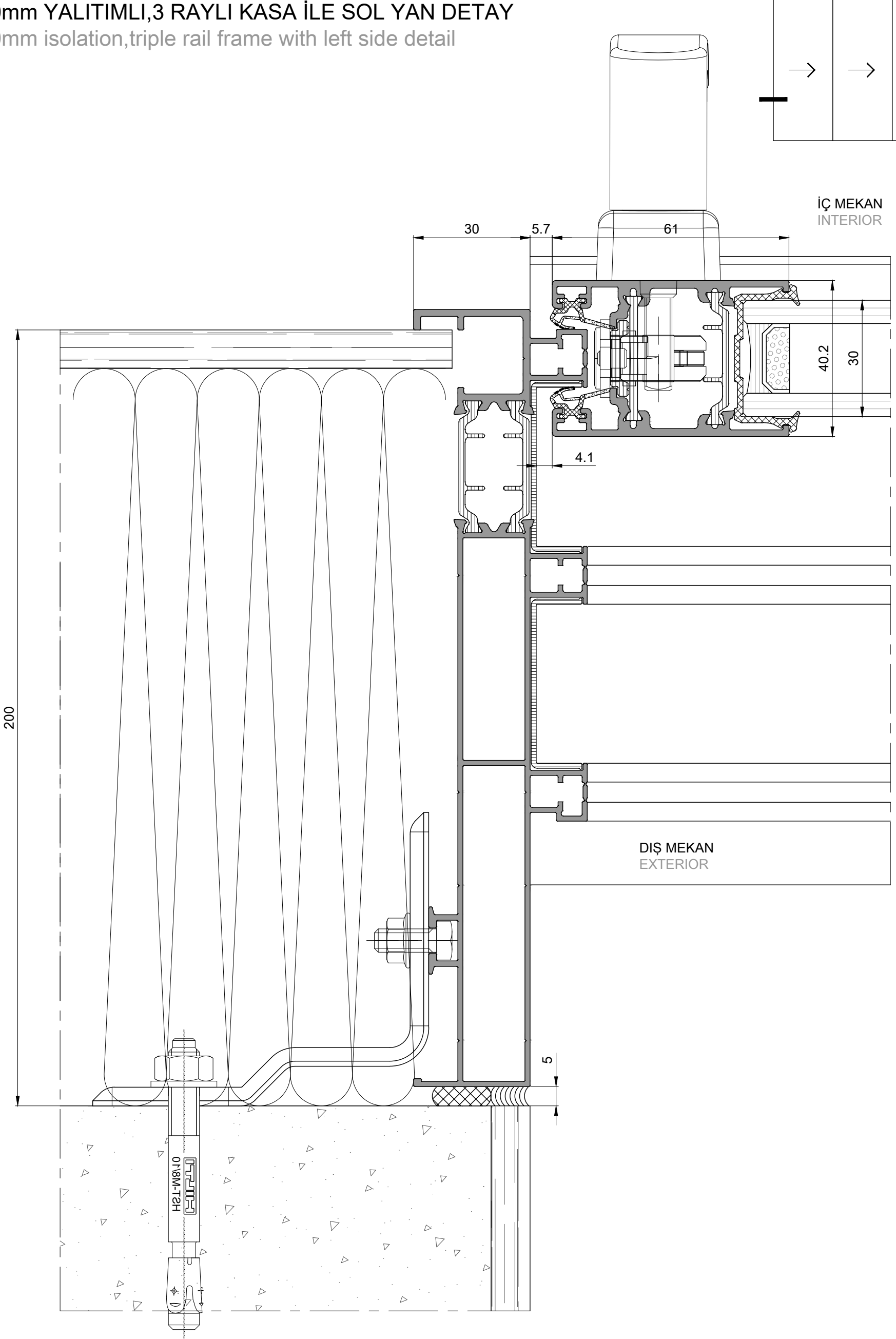

3 RAYLI KASA İLE KENET DETAY
triple rail frame with interlock detail

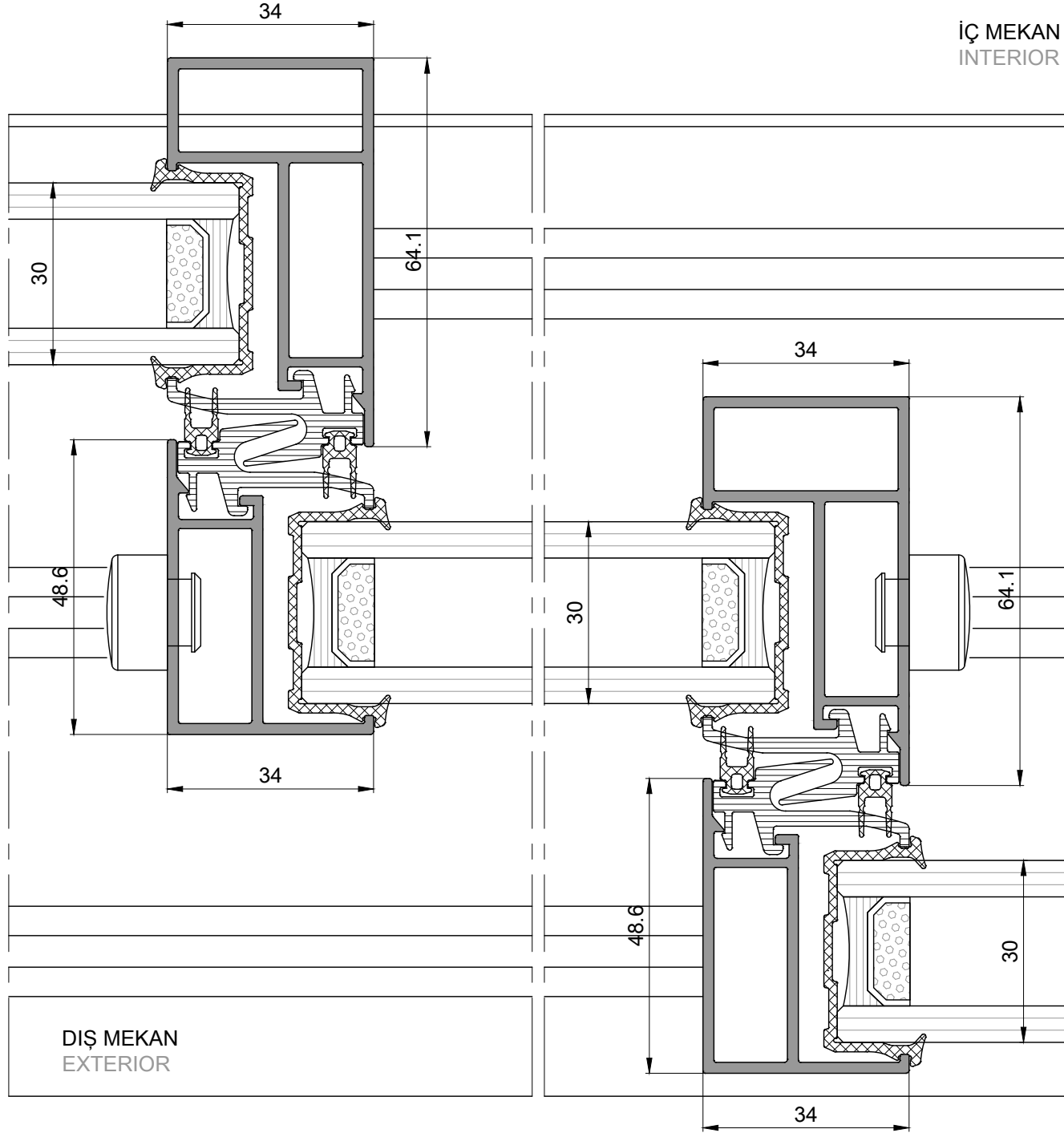
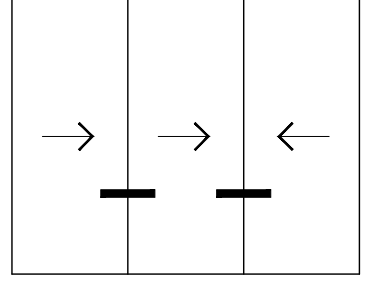

140mm YALITIMLI,3 RAYLI KASA İLE SAG YAN DETAY
140mm isolation, triple rail frame with right side detail

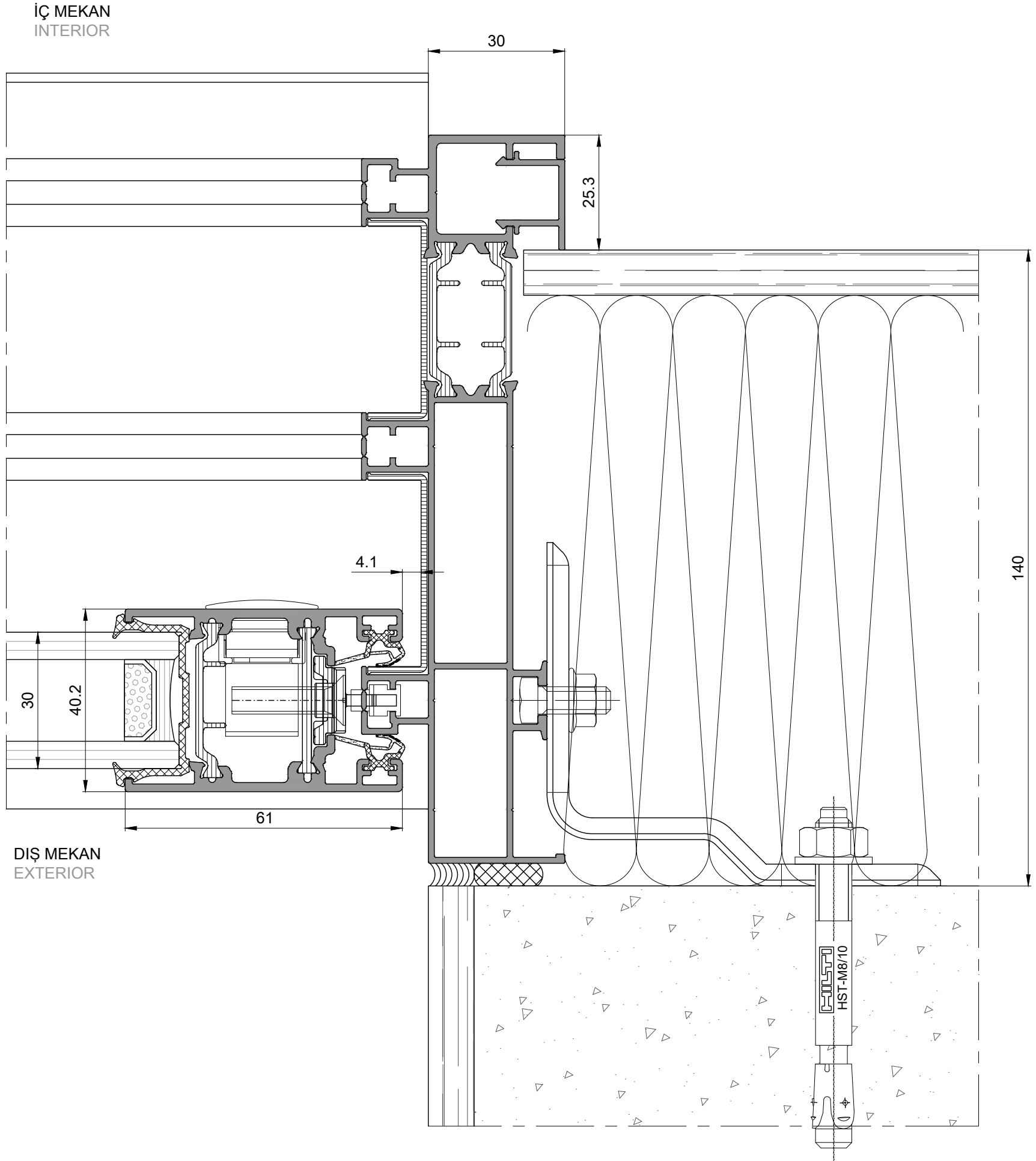
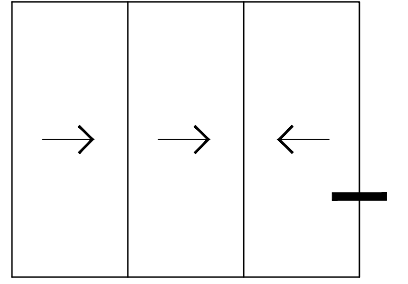

160mm YALITIMLI,3 RAYLI KASA İLE SAG YAN DETAY
160mm isolation, triple rail frame with right side detail

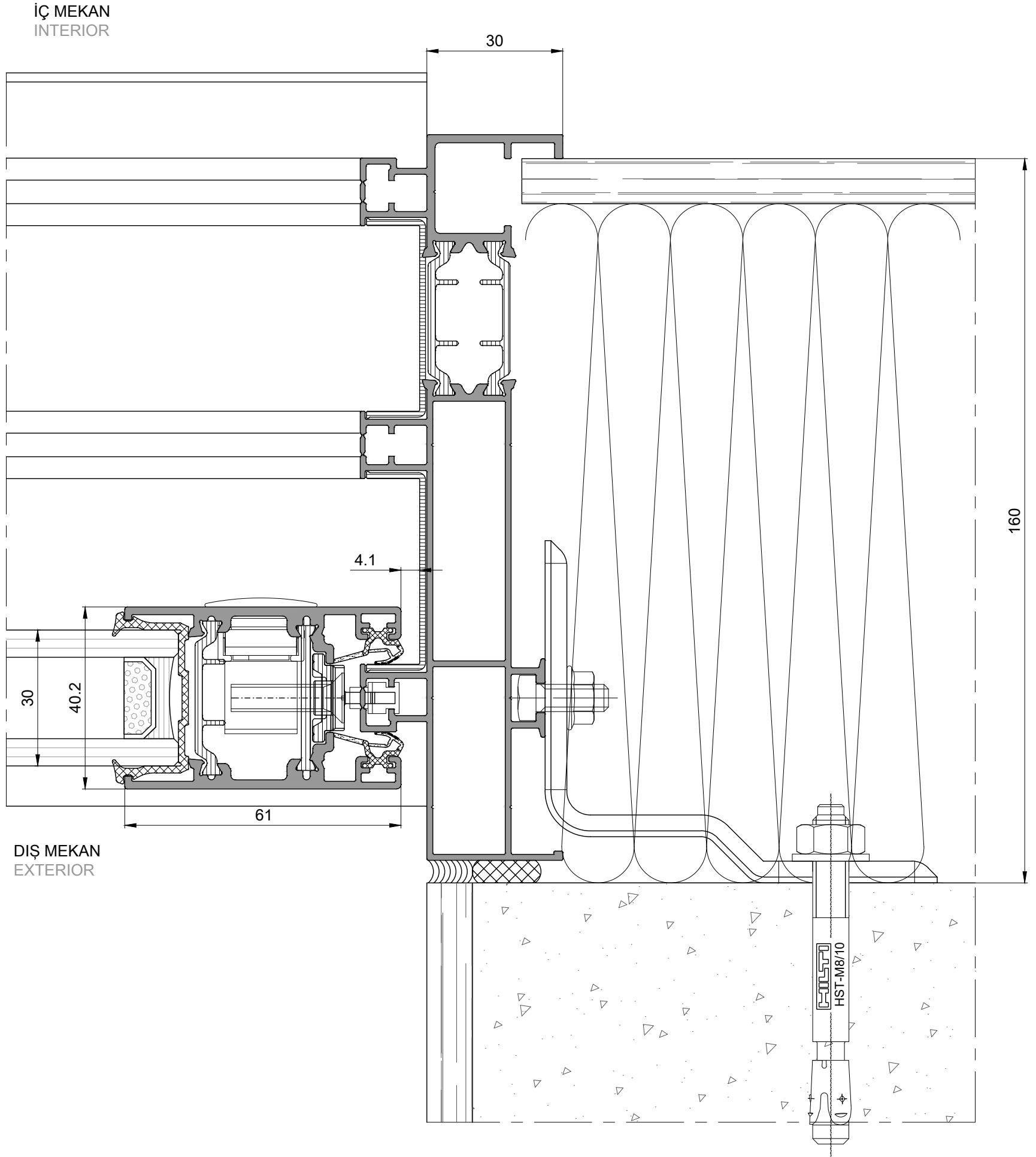
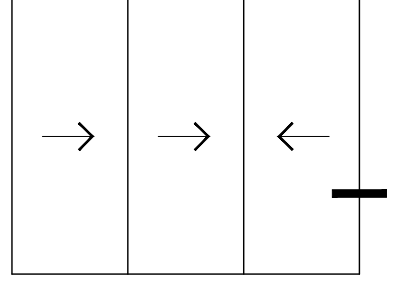

180mm YALITIMLI,3 RAYLI KASA İLE SAG YAN DETAY
180mm isolation,triple rail frame with right side detail

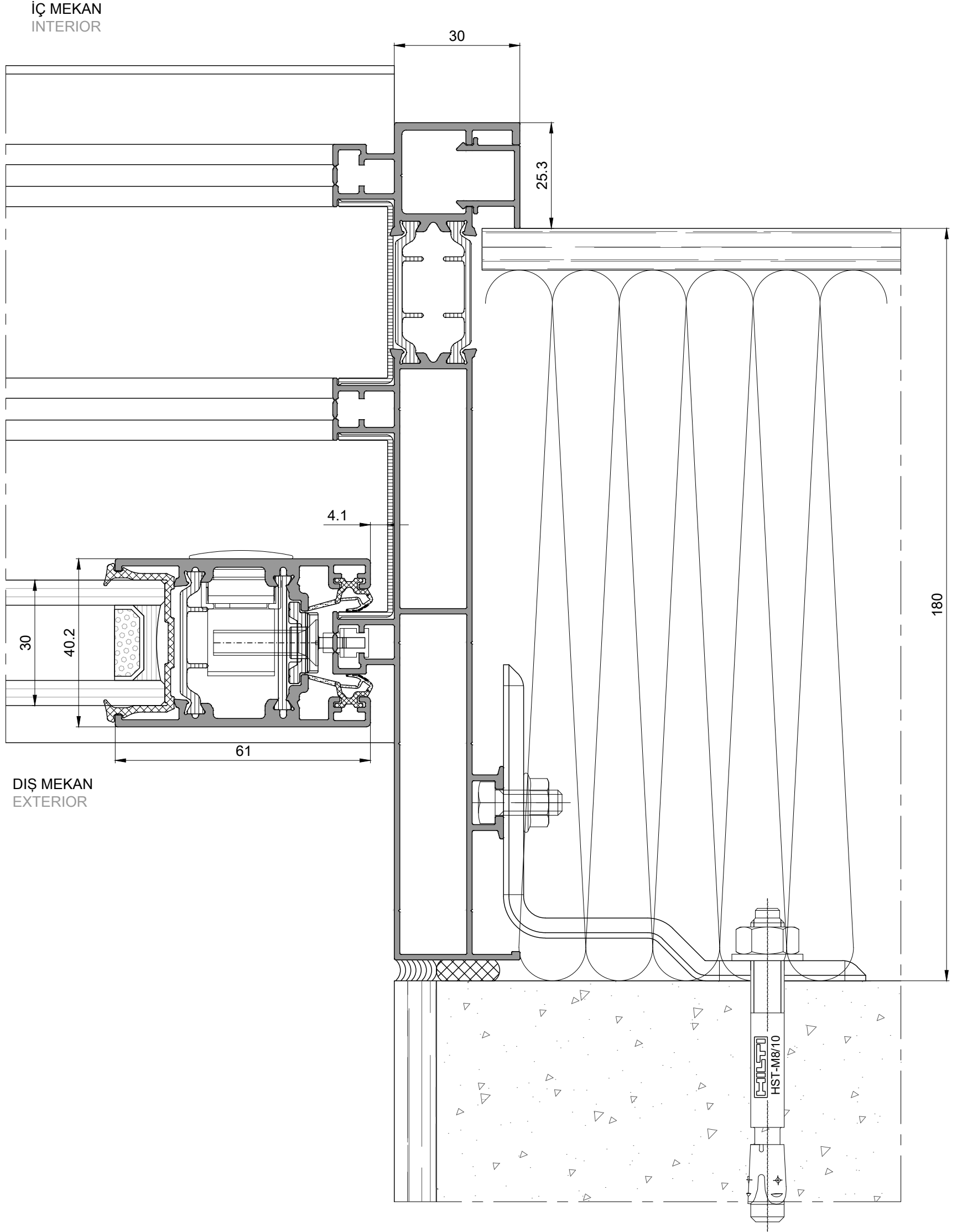
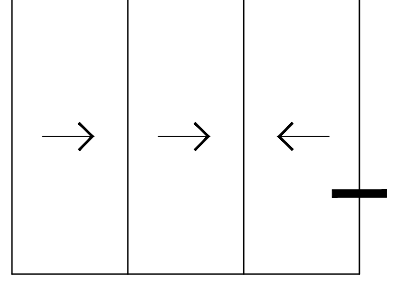

200mm YALITIMLI,3 RAYLI KASA İLE SAG YAN DETAY
200mm isolation, triple rail frame with right side detail

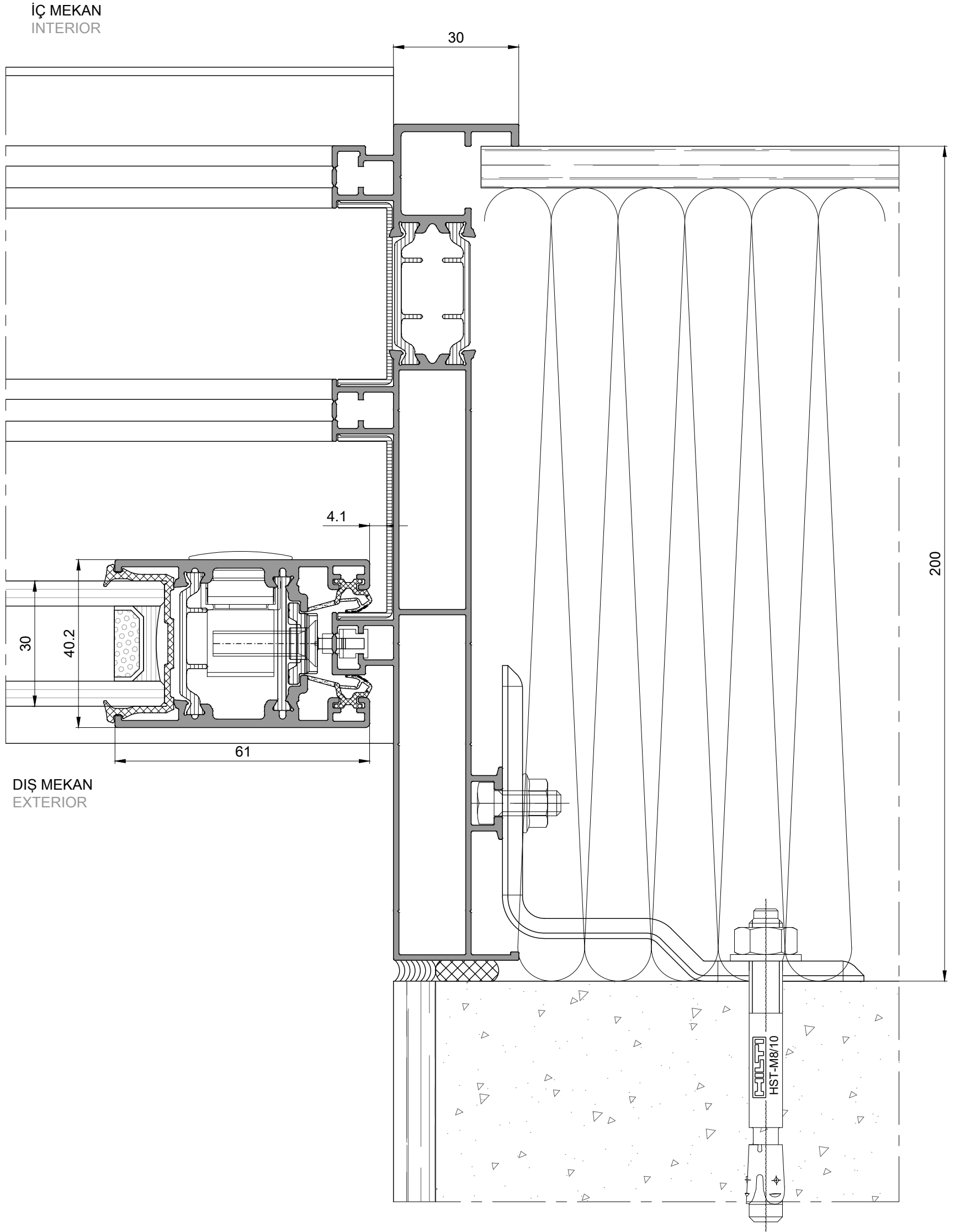
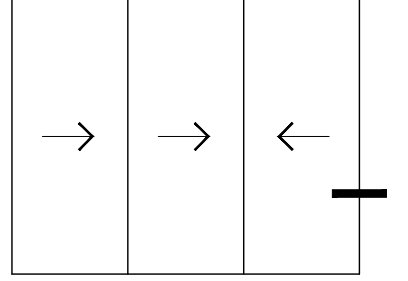

140mm YALITIMLI,3 RAYLI KASA İLE ÜST-İÇ KANAT DETAY
140mm isolation, triple rail frame with top side inner sash detail

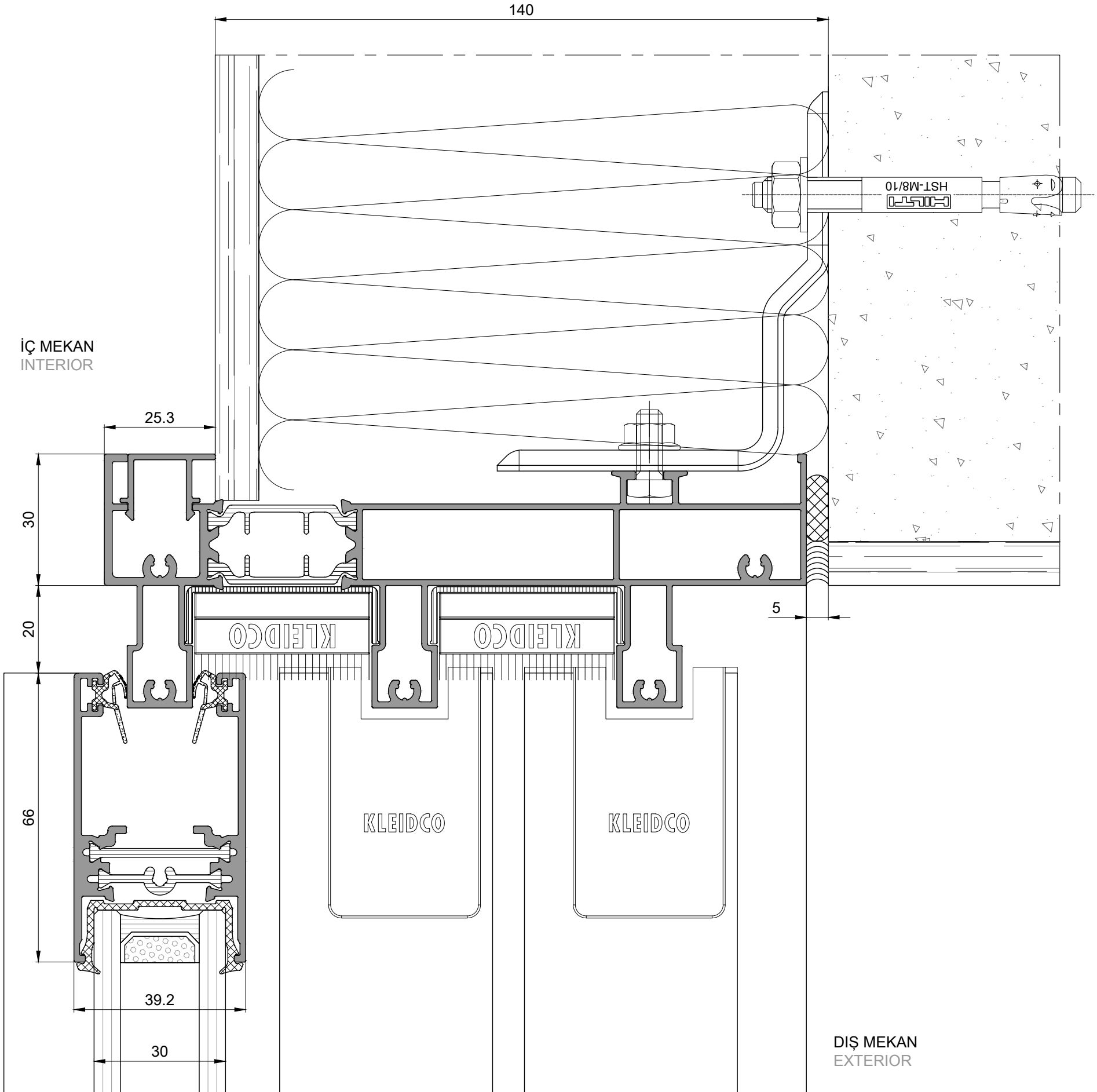
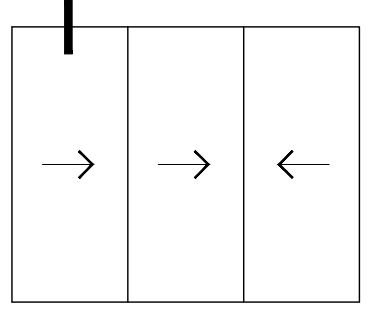

140mm YALITIMLI,3 RAYLI KASA İLE ÜST-ORTA KANAT DETAY
140mm isolation, triple rail frame with top side middle sash detail

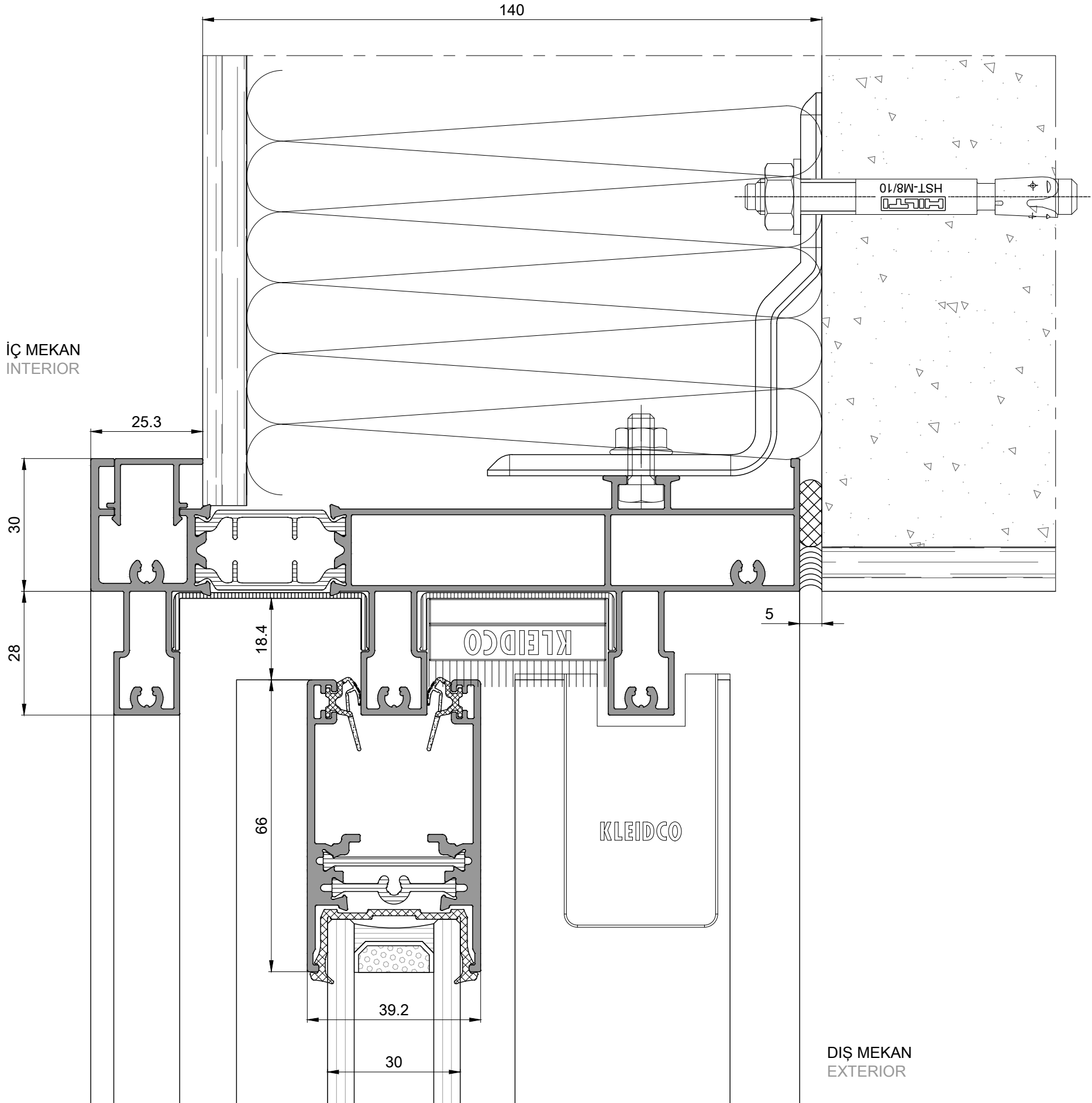
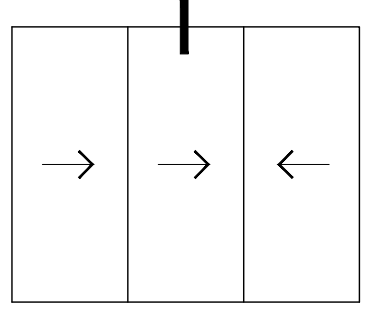

140mm YALITIMLI,3 RAYLI KASA İLE ÜST-SAG KANAT DETAY
140mm isolation, triple rail frame with top side right sash detail

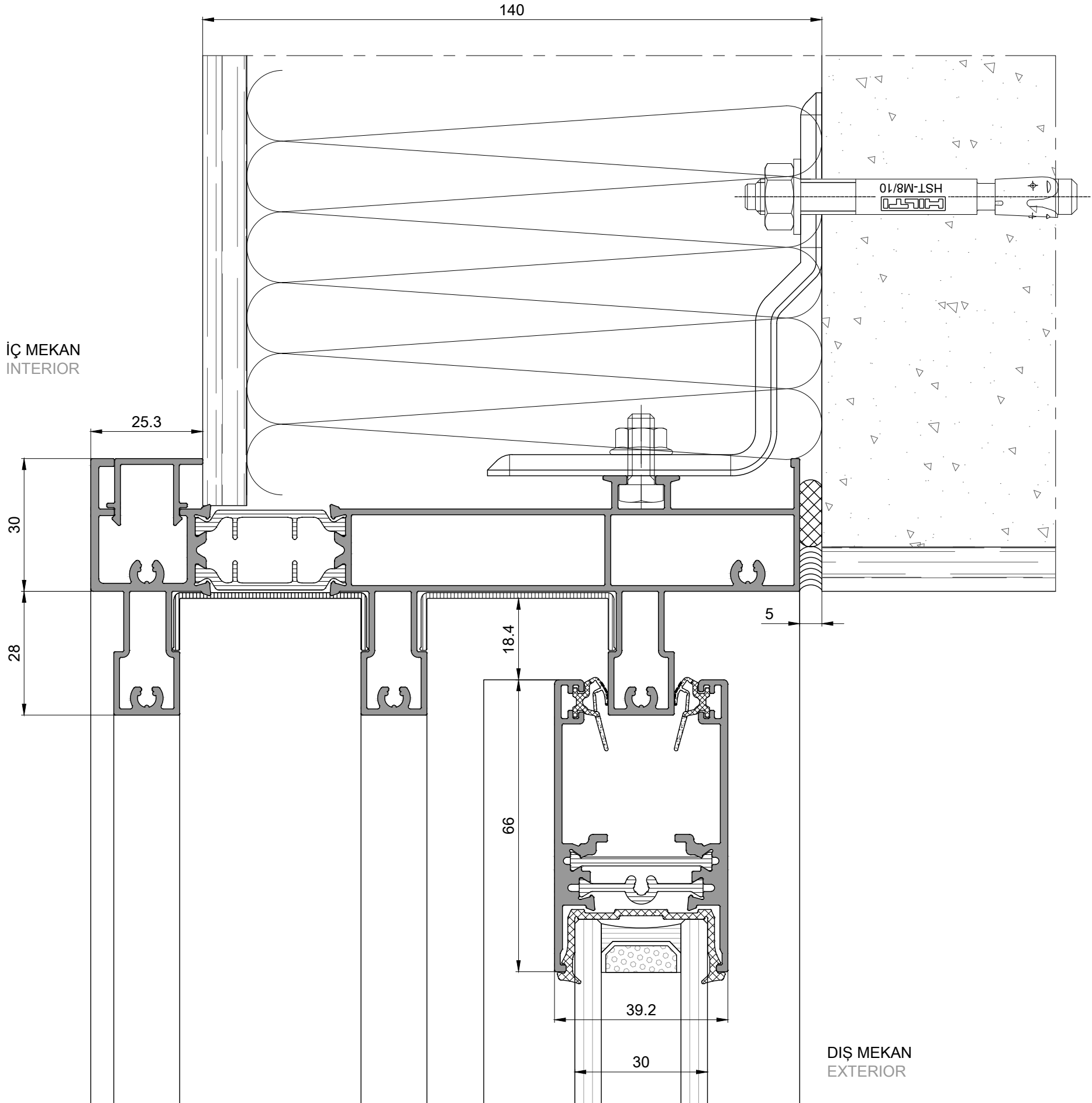
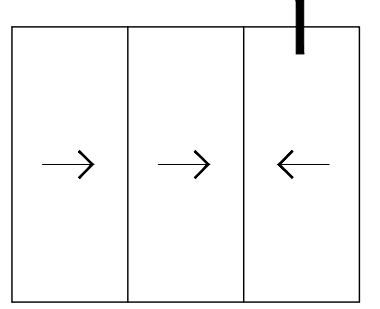

160mm YALITIMLI,3 RAYLI KASA İLE ÜST-İÇ KANAT DETAY
160mm isolation, triple rail frame with top side inner sash detail

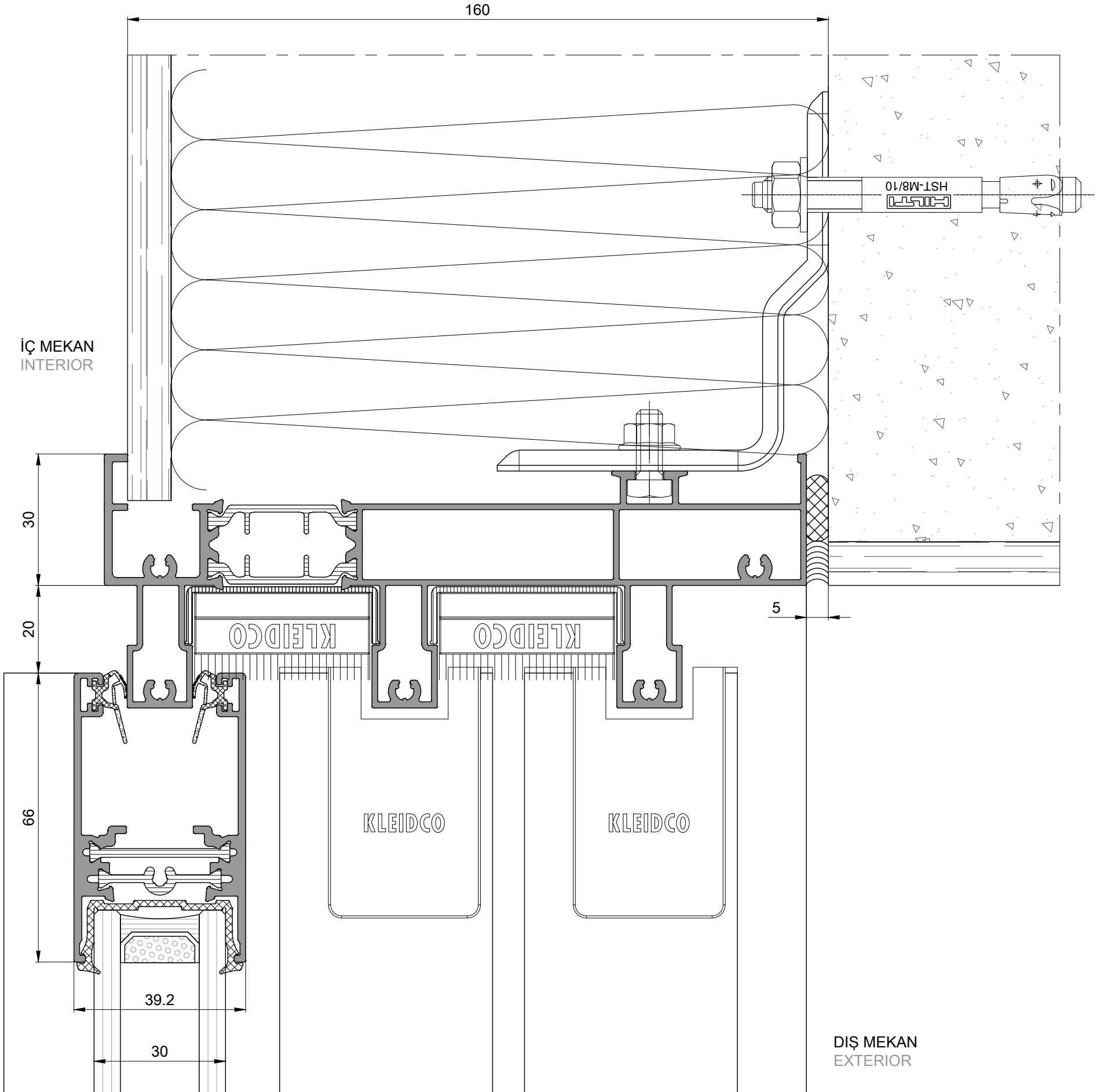
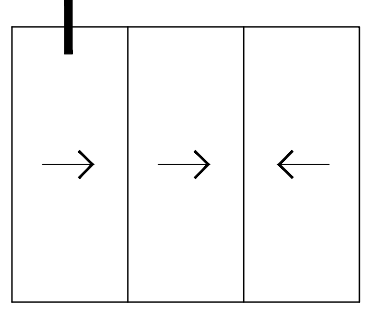

160mm YALITIMLI,3 RAYLI KASA İLE ÜST-ORTA KANAT DETAY
160mm isolation, triple rail frame with top side middle sash detail

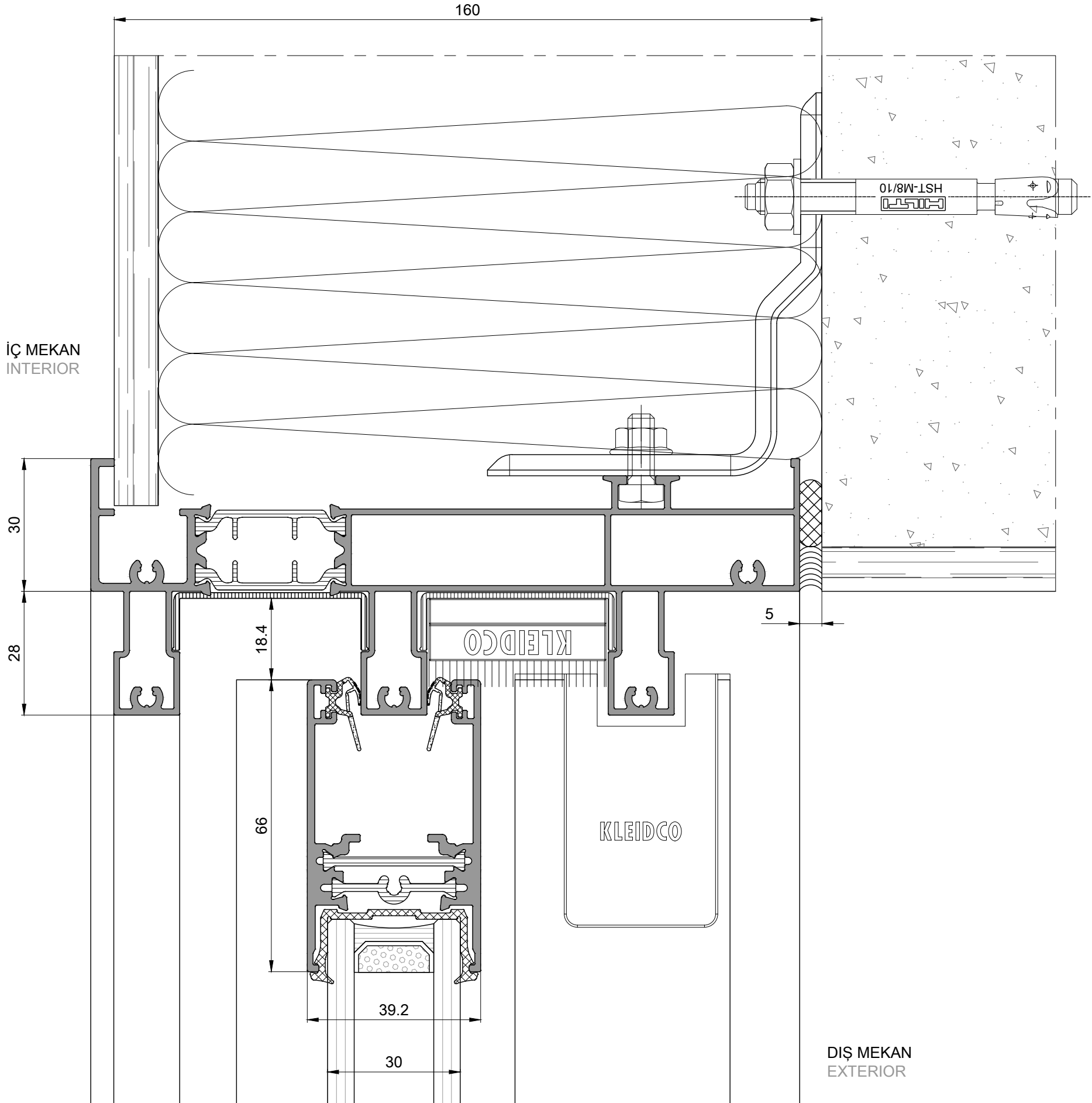
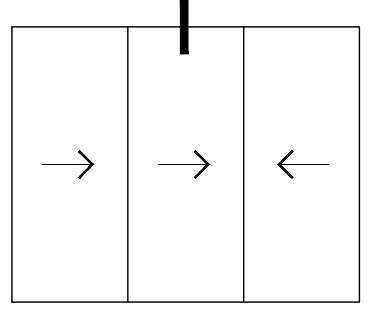

160mm YALITIMLI,3 RAYLI KASA İLE ÜST-SAG KANAT DETAY
160mm isolation, triple rail frame with top side right sash detail

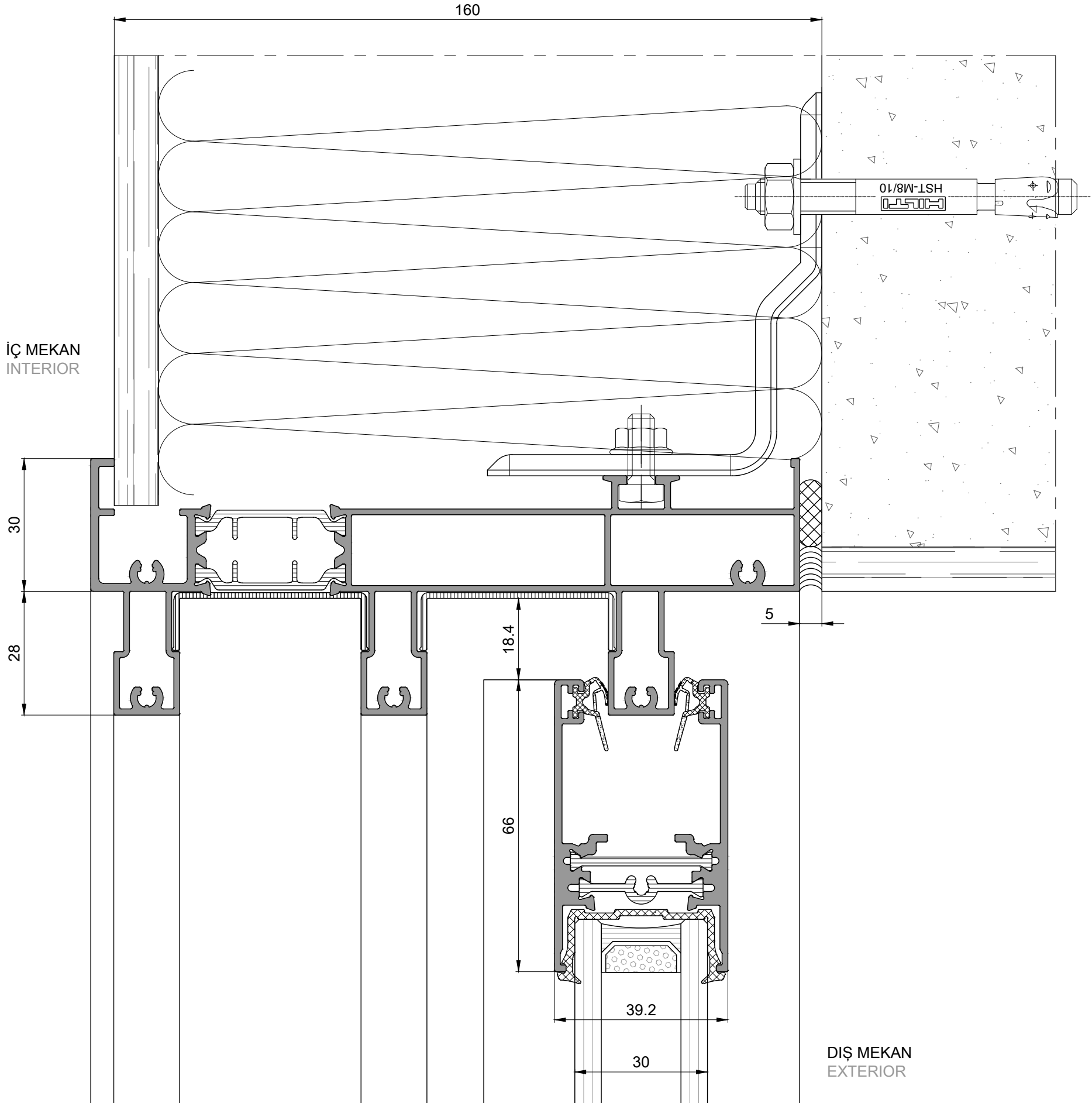
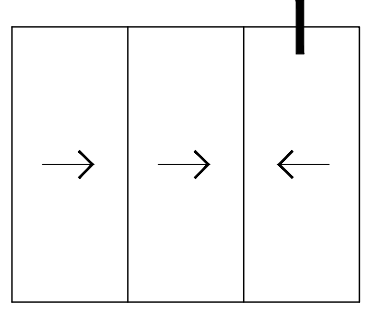

180mm YALITIMLI,3 RAYLI KASA İLE ÜST-İÇ KANAT DETAY
180mm isolation, triple rail frame with top side inner sash detail

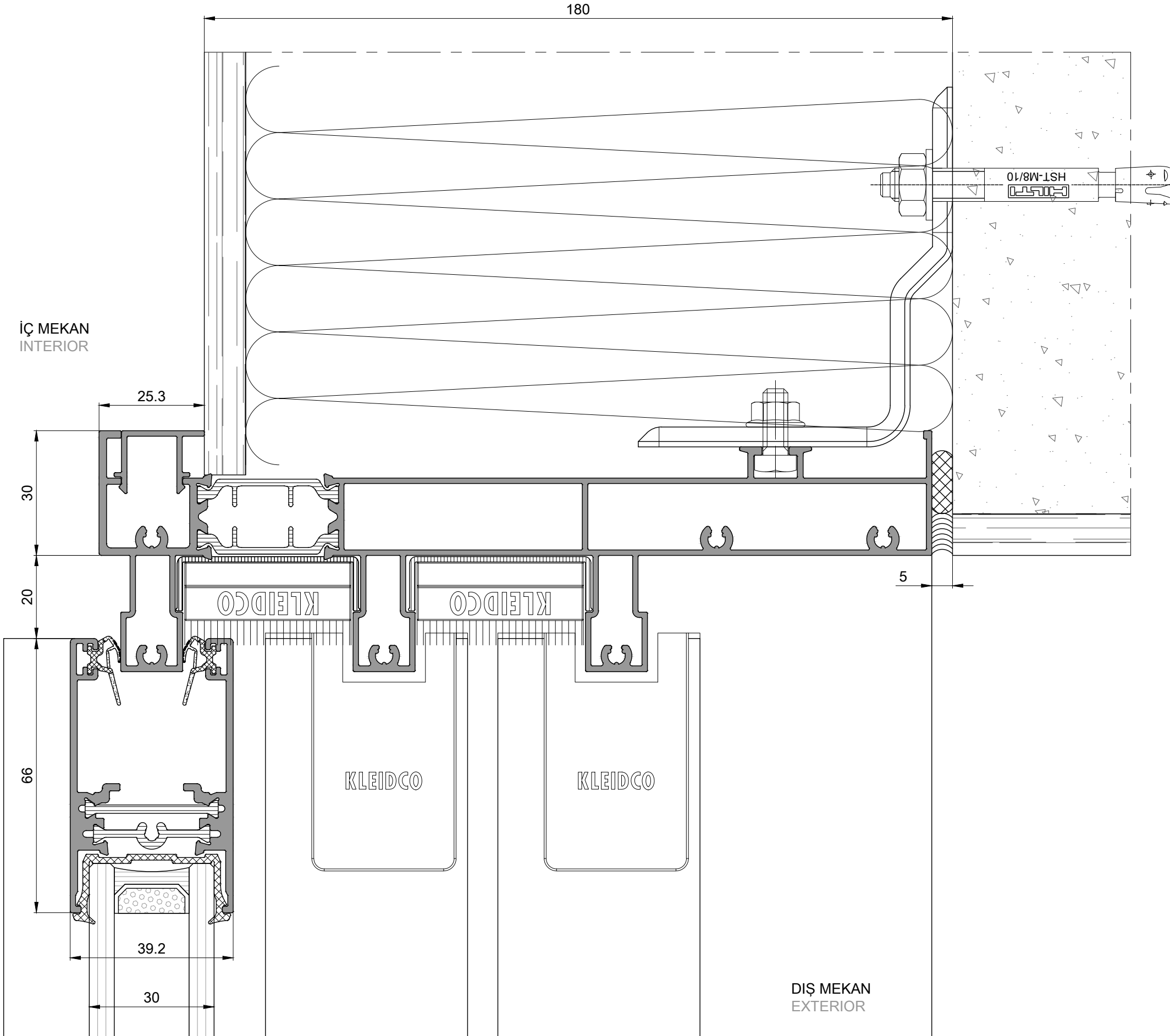
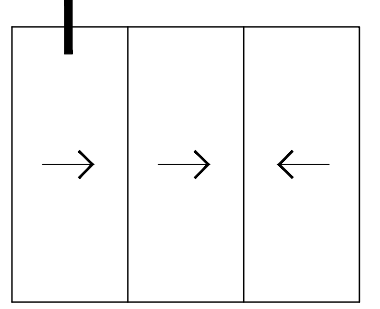

180mm YALITIMLI,3 RAYLI KASA İLE ÜST-ORTA KANAT DETAY
180mm isolation, triple rail frame with top side middle sash detail

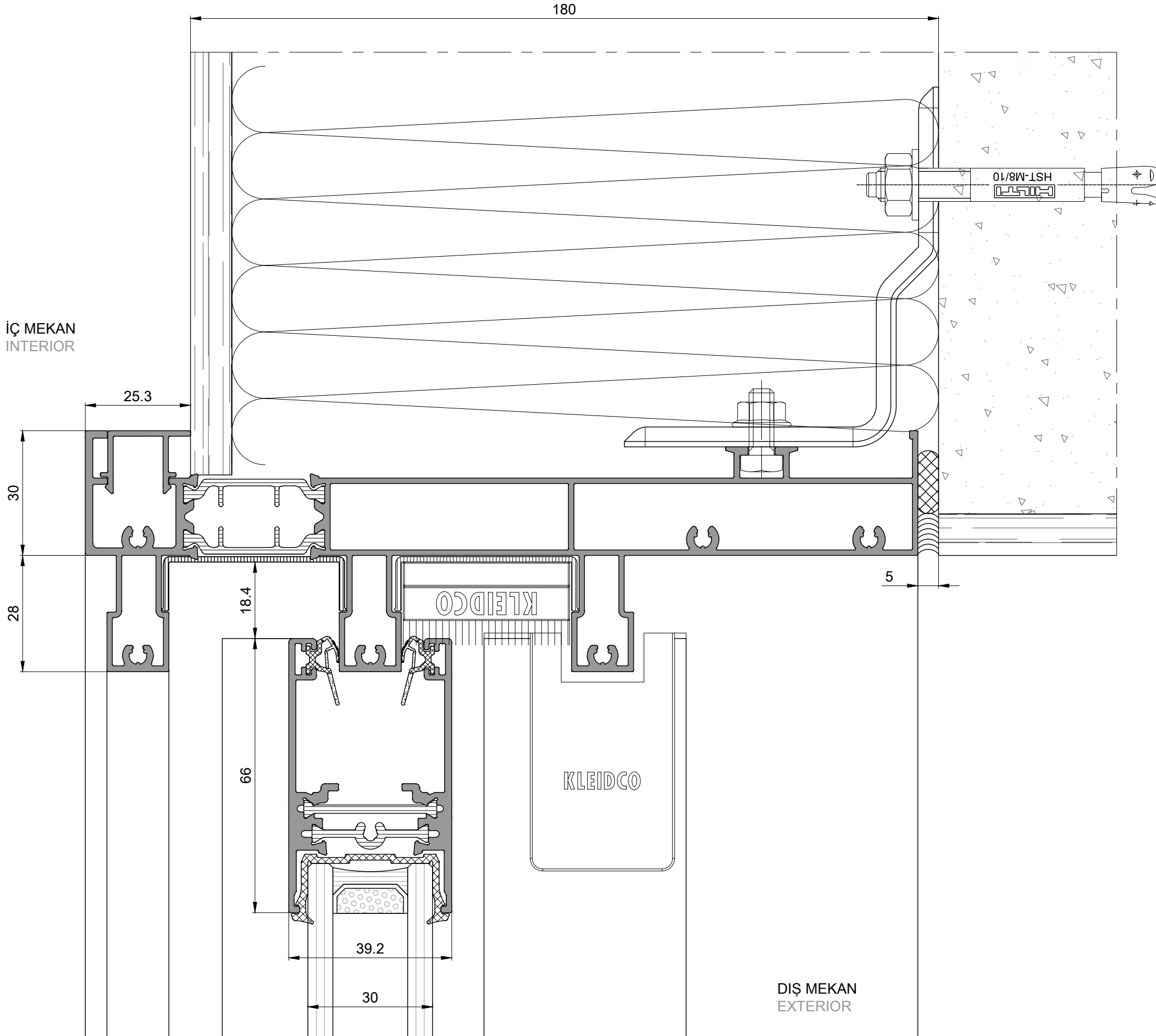
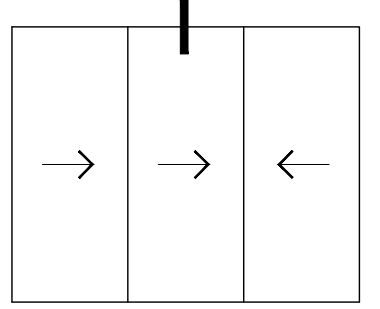

180mm YALITIMLI,3 RAYLI KASA İLE ÜST-SAG KANAT DETAY
180mm isolation, triple rail frame with top side right sash detail

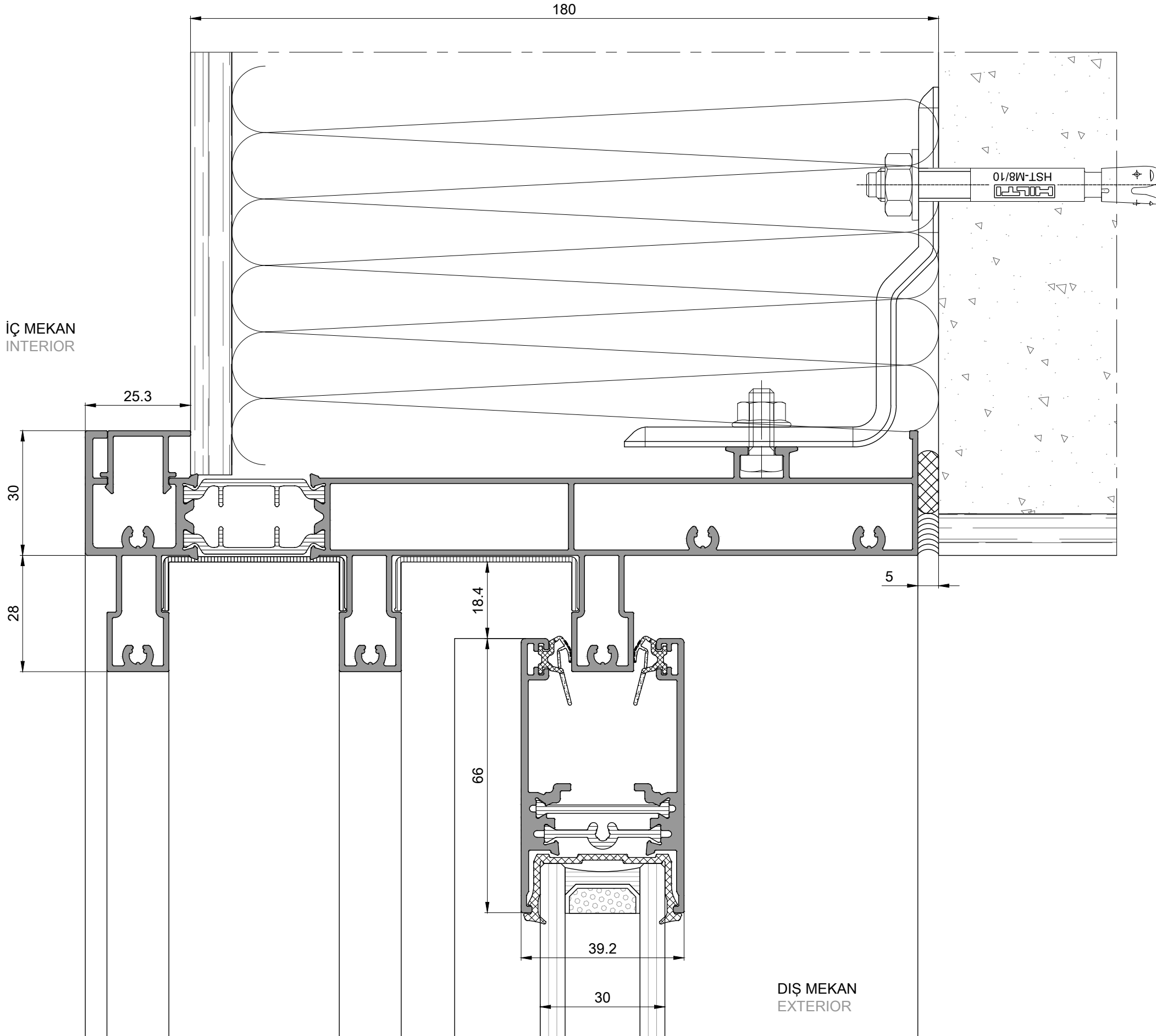
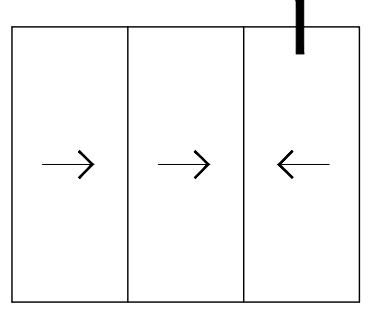

200mm YALITIMLI,3 RAYLI KASA İLE ÜST-İÇ KANAT DETAY
200mm isolation, triple rail frame with top side inner sash detail

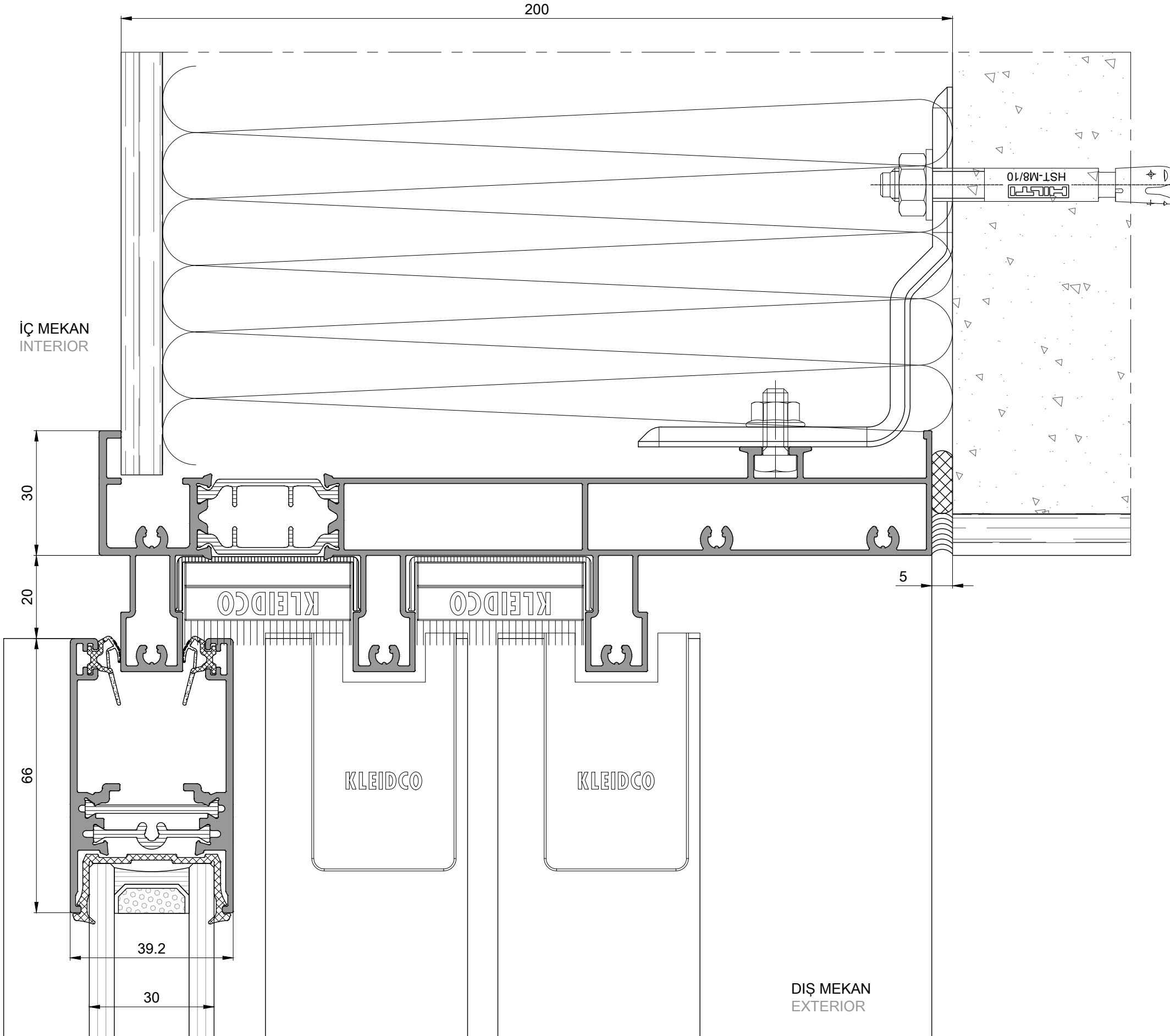
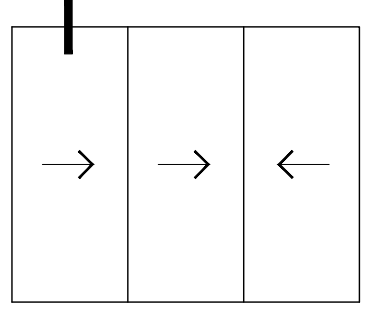

200mm YALITIMLI,3 RAYLI KASA İLE ÜST-ORTA KANAT DETAY
200mm isolation,triple rail frame with top side middle sash detail

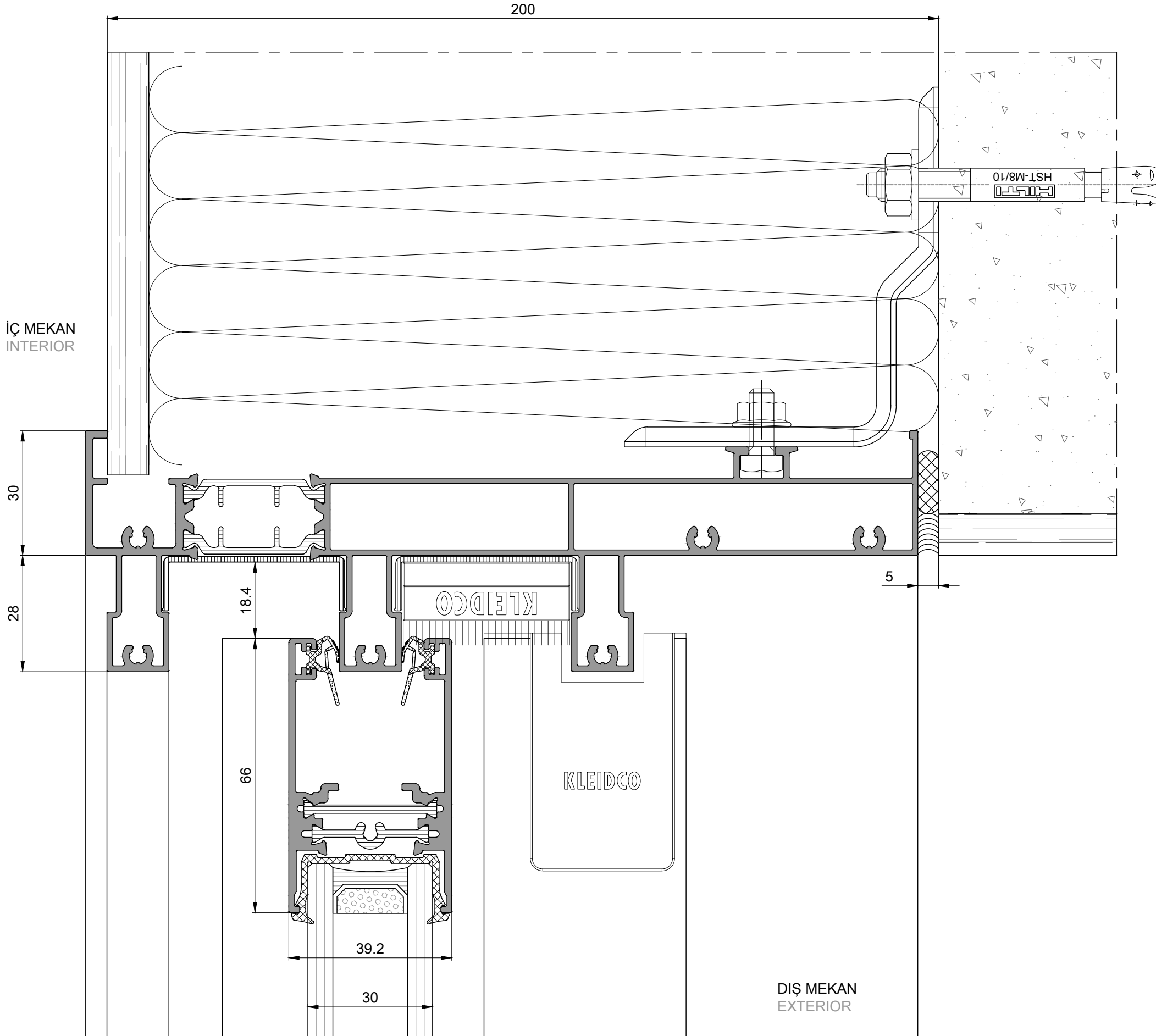
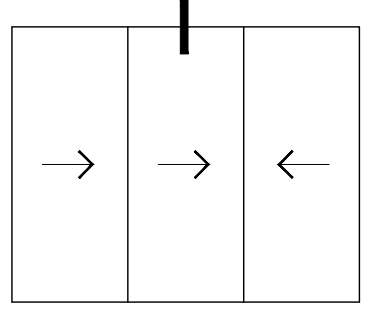

200mm YALITIMLI,3 RAYLI KASA İLE ÜST-SAG KANAT DETAY
200mm isolation, triple rail frame with top side right sash detail

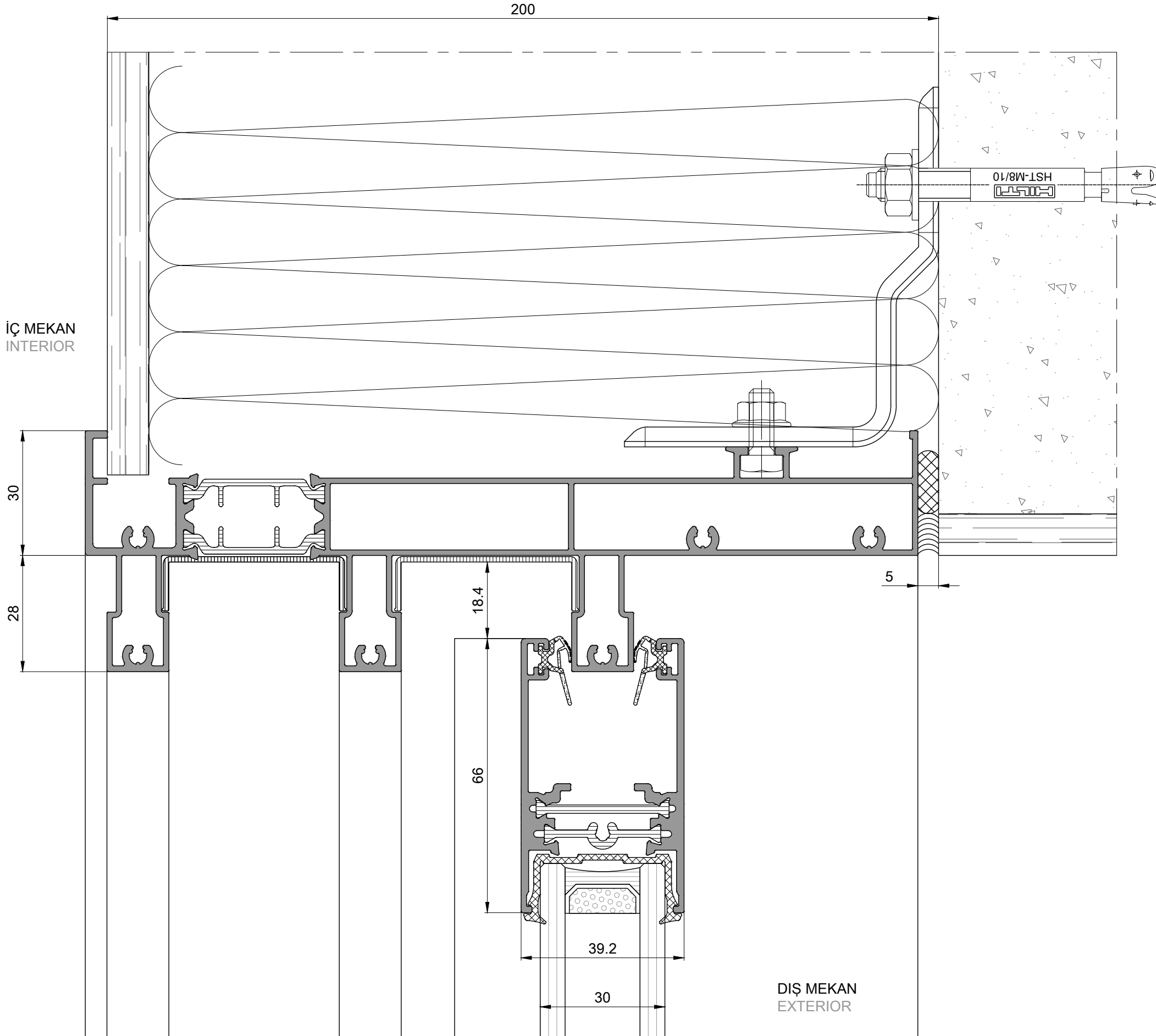
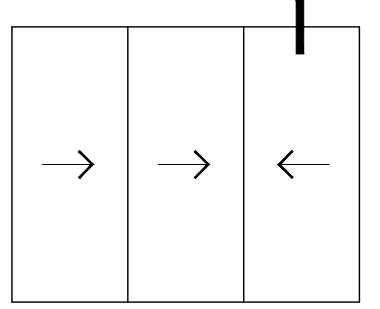

140-160-180-200mm YALITIMLI 3 RAYLI KASA ALT-İÇ KANAT DETAY
140-160-180-200mm isolation, triple rail frame with bottom side inner sash detail

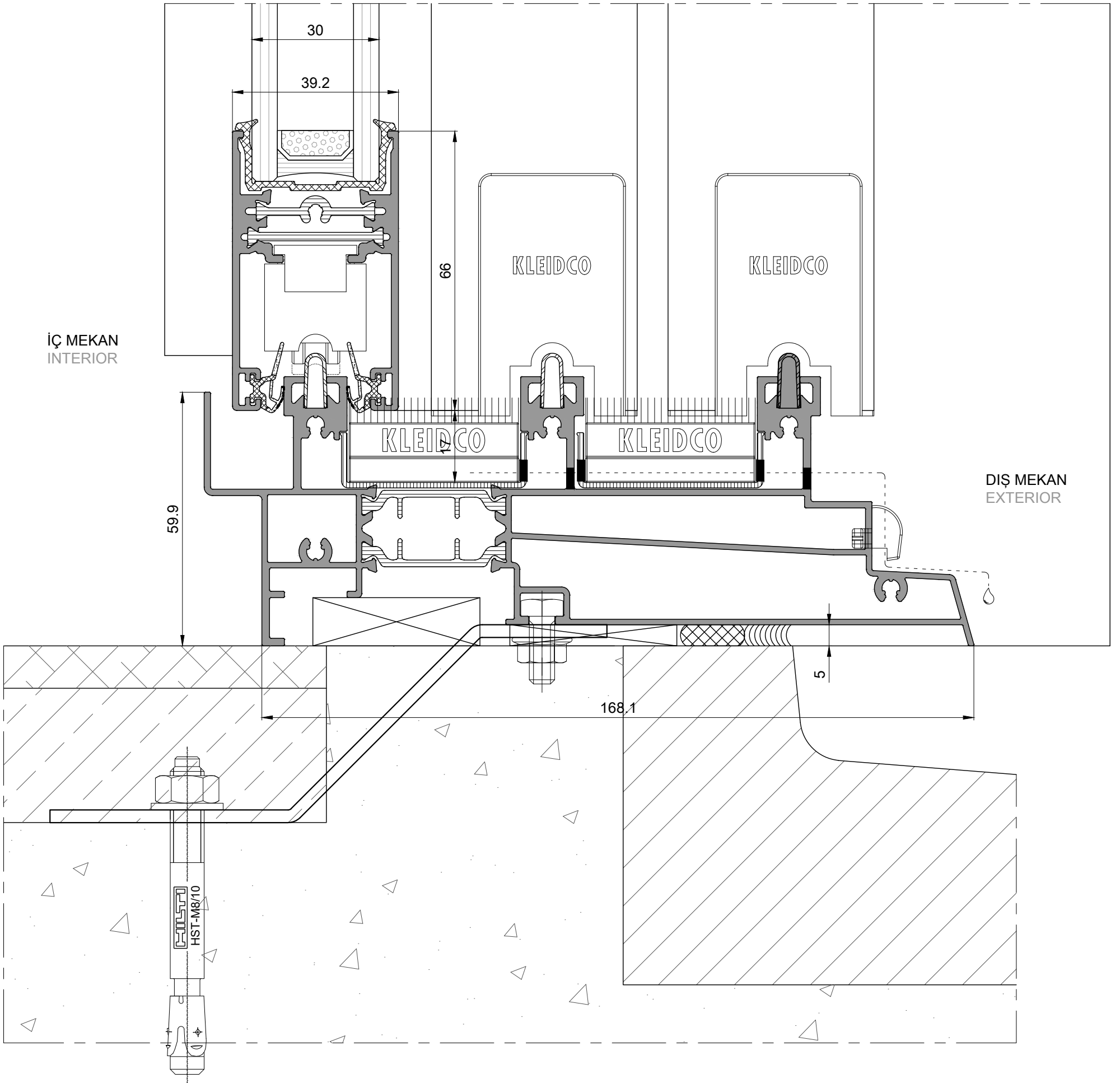
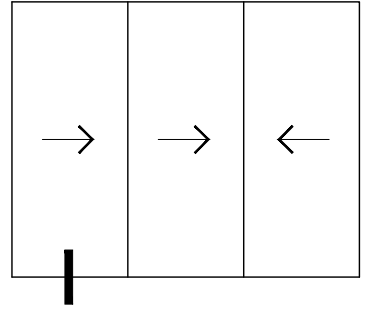

140-160-180-200mm YALITIMLI 3 RAYLI KASA ALT-ORTA KANAT DETAY
140-160-180-200mm isolation, triple rail frame with bottom side middle sash detail

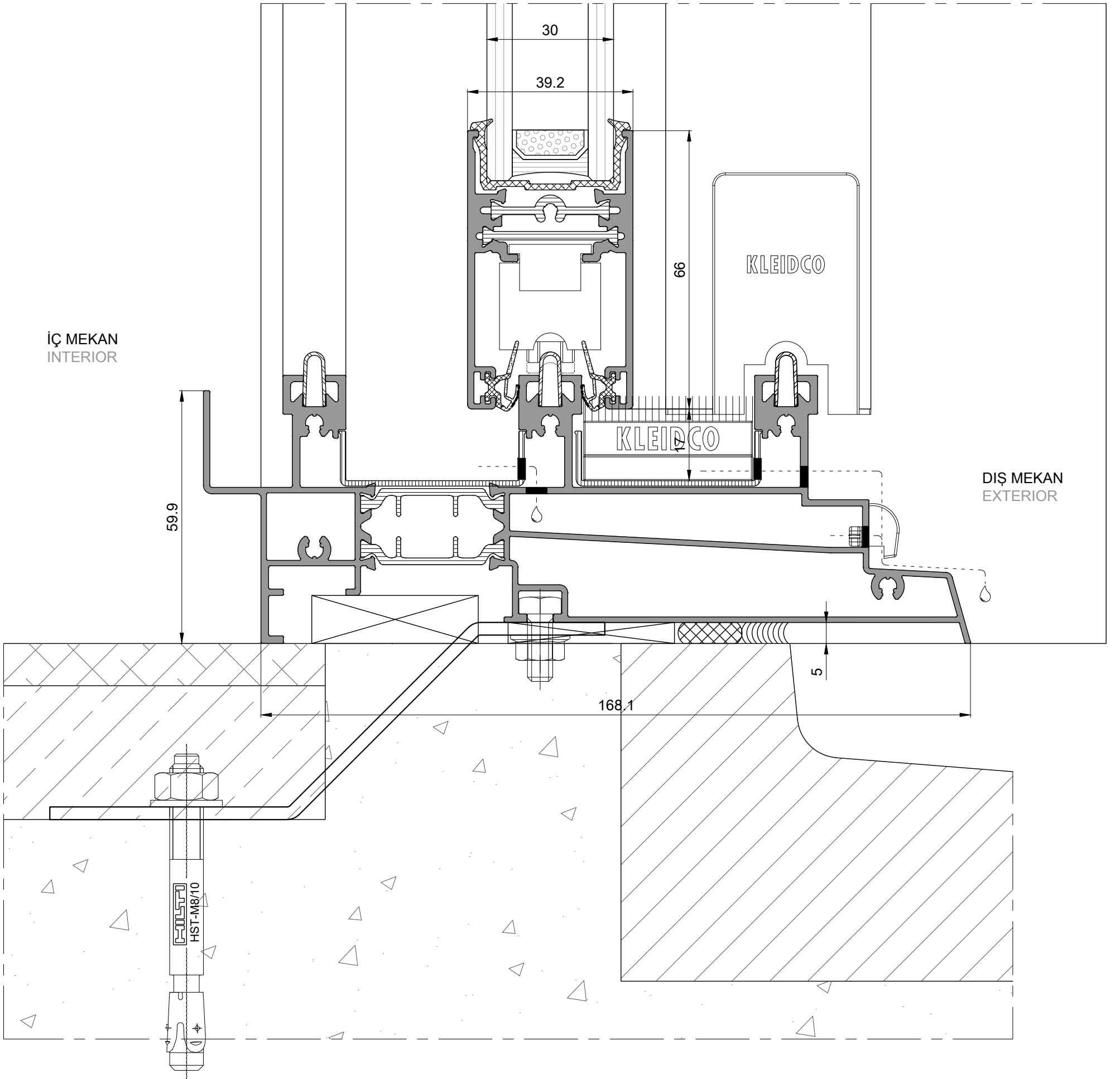
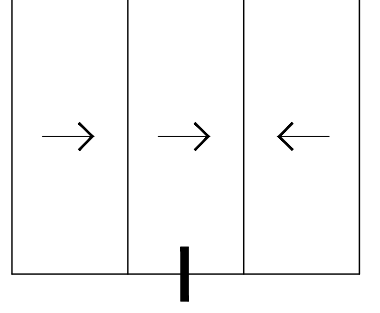

140-160-180-200mm YALITIMLI 3 RAYLI KASA ALT-SAG KANAT DETAY
140-160-180-200mm isolation, triple rail frame with bottom side right sash detail

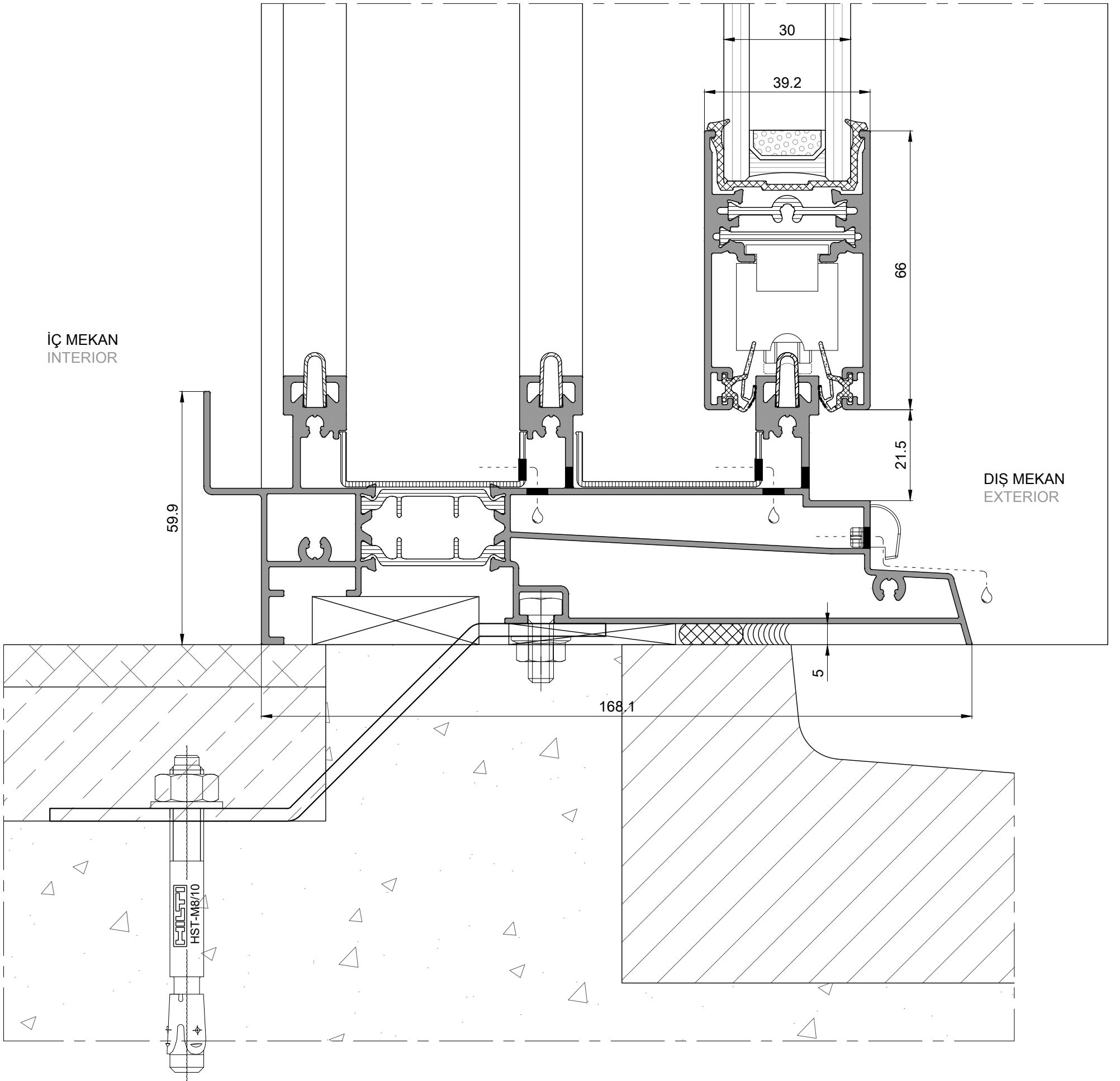
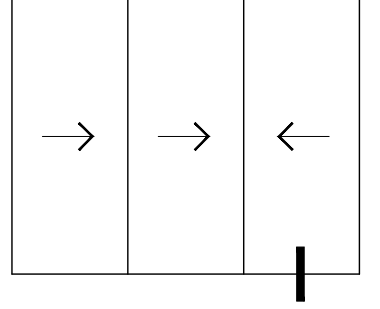

MOTIONslide
SÜRME KAPI ve PENCERE SİSTEMİ
SLIDING WINDOW and DOOR SYSTEM

2 RAYLI ve PANJURLU SÜRME
PRENSİP SİSTEM DETAYLARI
PRINCIPAL SECTIONS for
DOUBLE RAIL SLIDING
with ROLLER SYSTEM

120mm YALITIMLI ve PANJURLU SOL YAN DETAY
120mm isolation and roller with left side detail

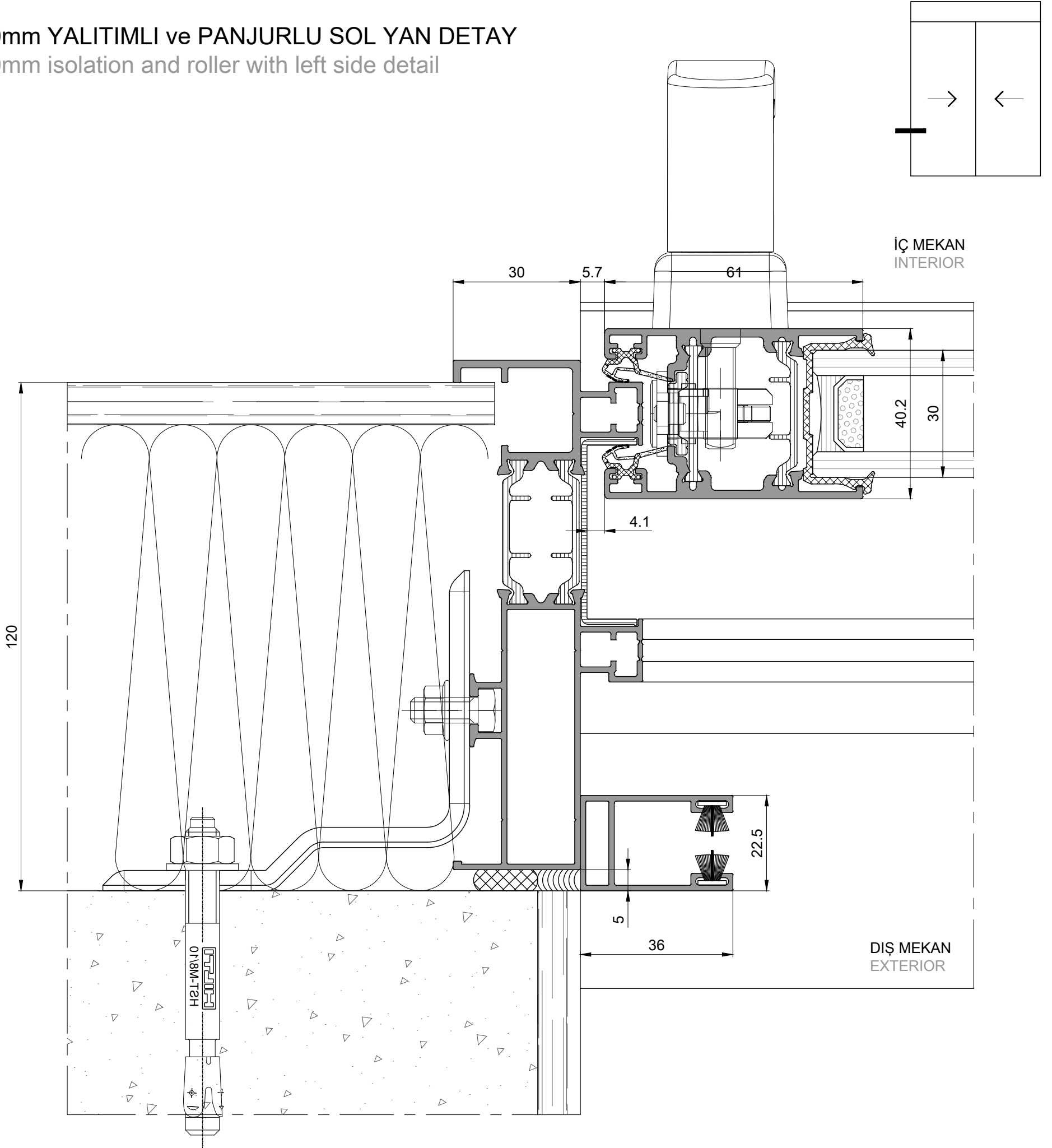

KENET DETAY
interlock detail

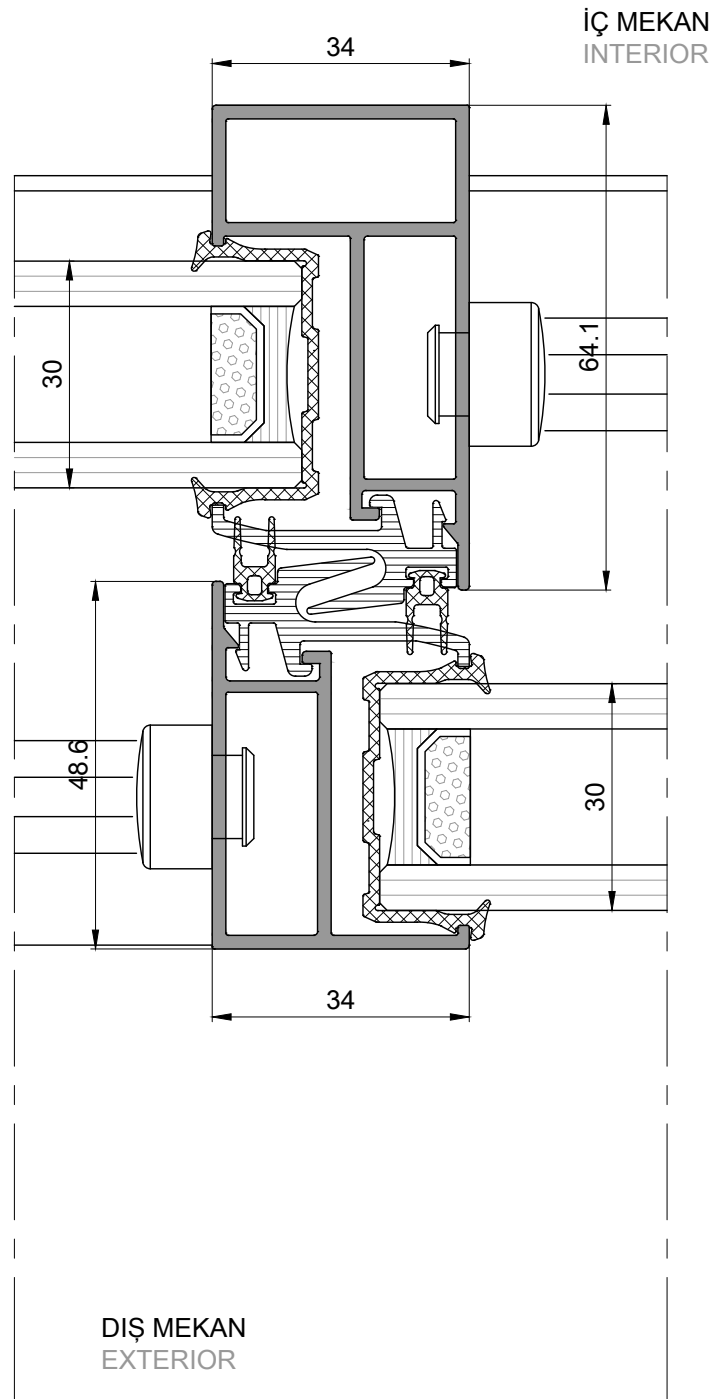
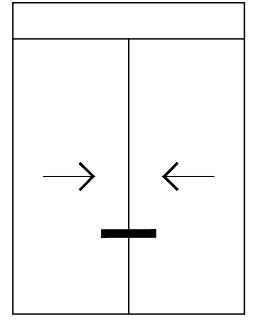

ÇİFT KANAT DETAY
double sash detail

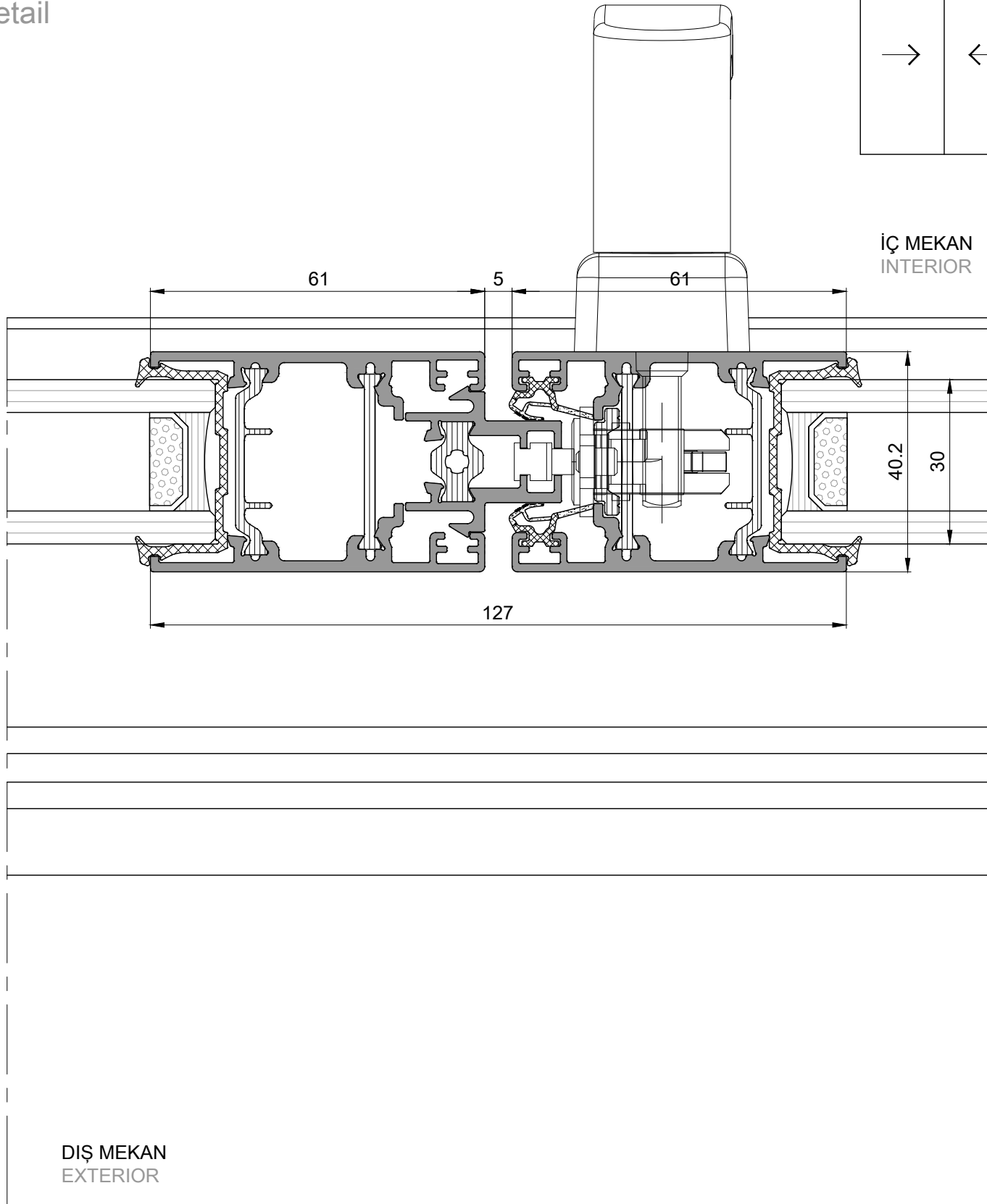
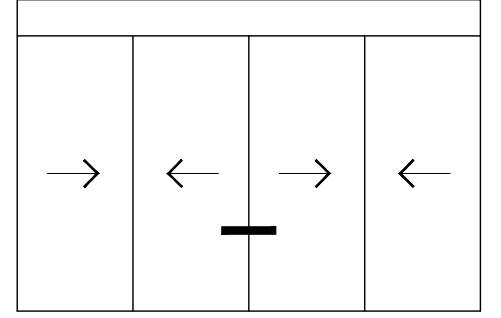

120mm YALITIMLI ve PANJURLU SAG YAN DETAY
120mm isolation and roller with right side detail

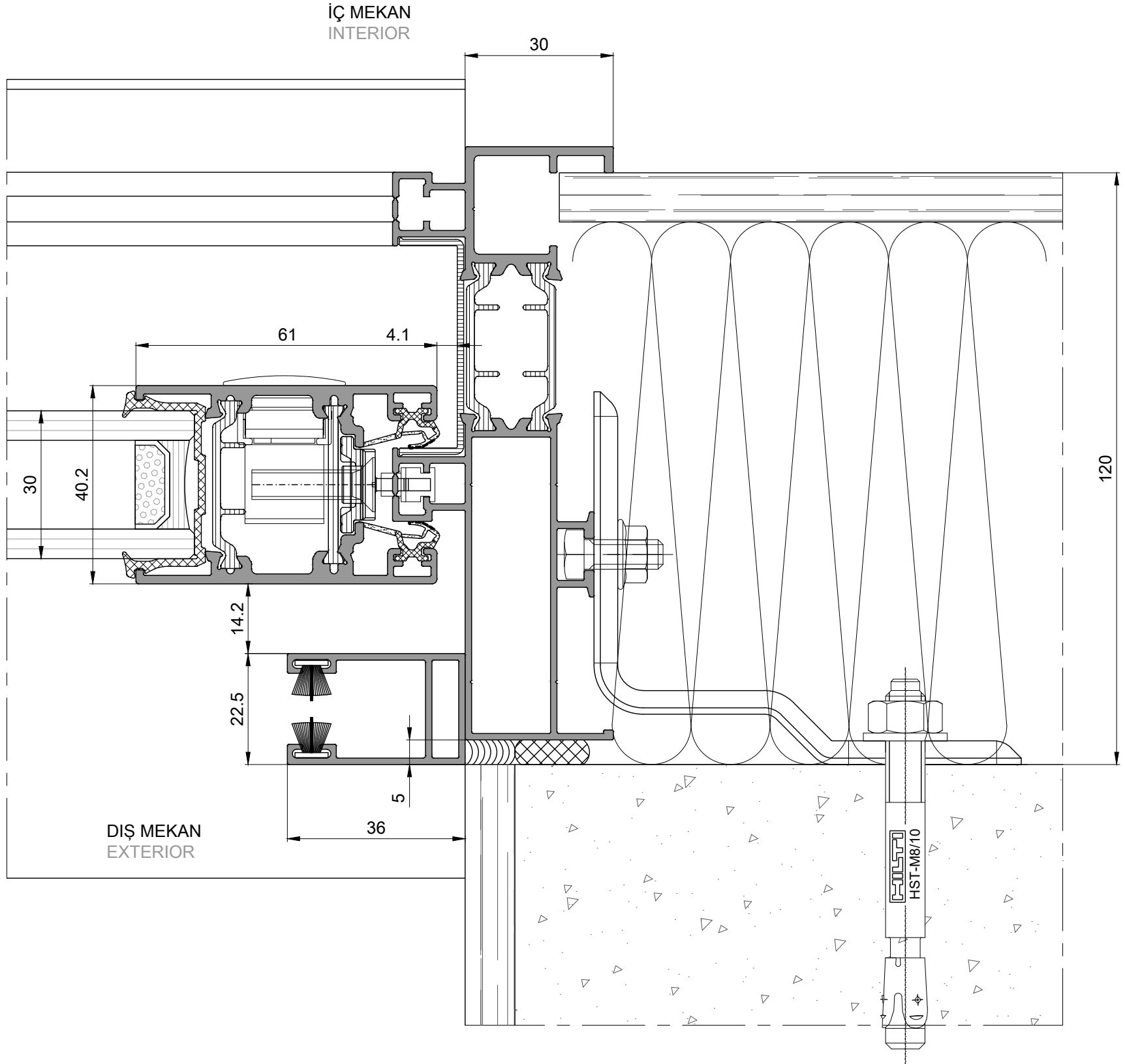
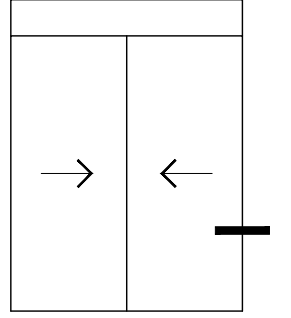

120mm YALITIMLI ve PANJURLU ÜST İÇ KANAT DETAY
120mm isolation and roller with top side inner sash detail

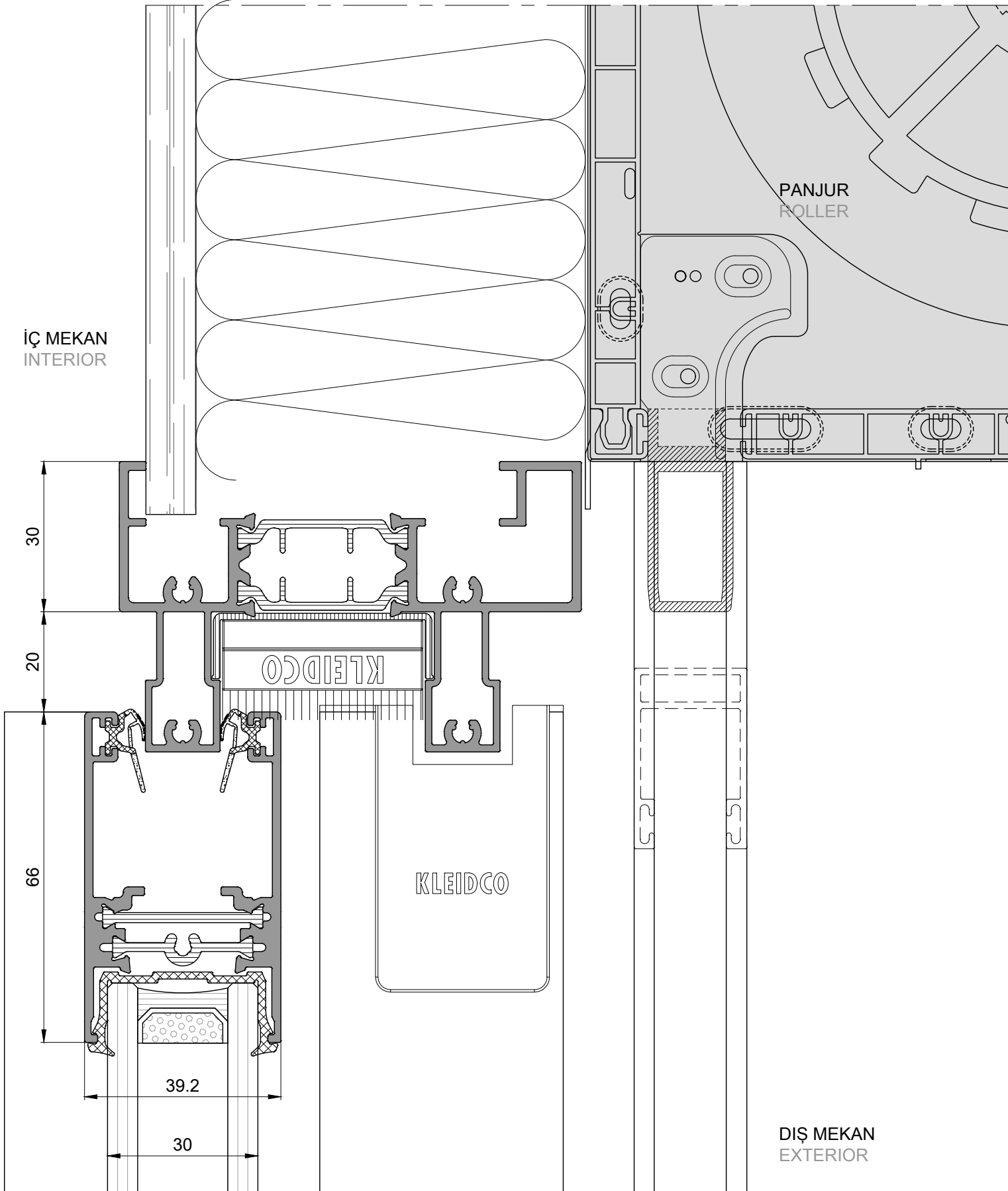
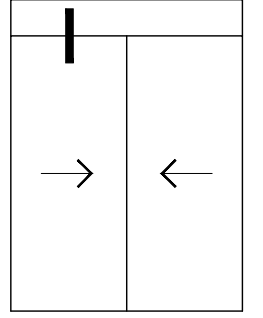

120mm YALITIMLI ve PANJURLU ÜST DIŞ KANAT DETAY
120mm isolation and roller with top side outer sash detail

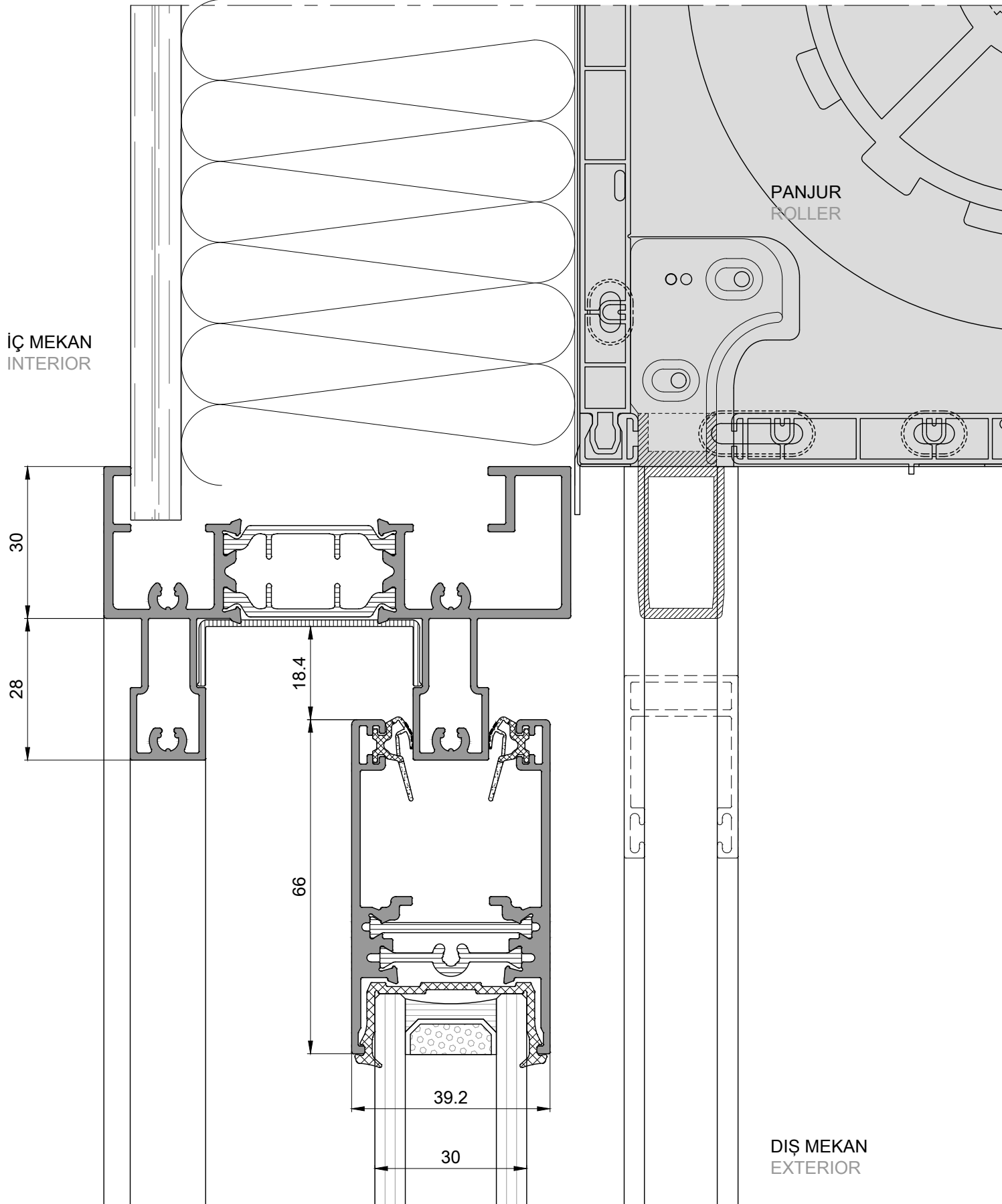
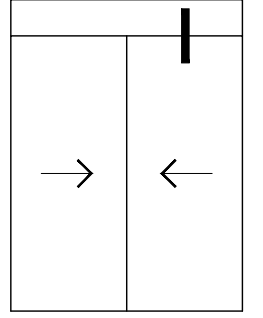

120mm YALITIMLI ve PANJURLU ÜST İÇ KANAT DETAY
120mm isolation and roller with top side inner sash detail

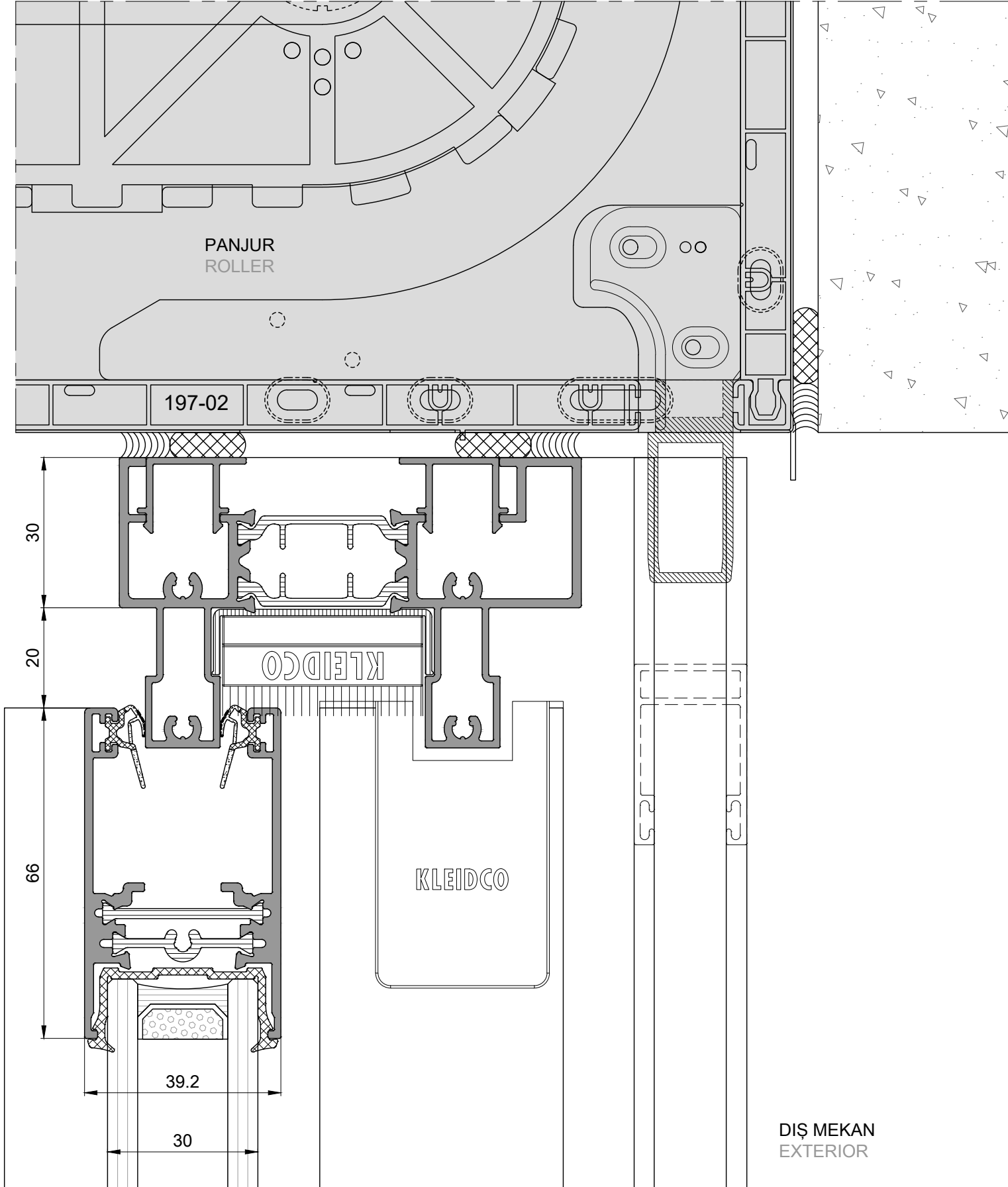
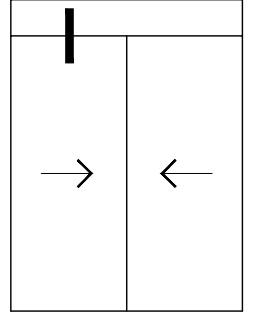

120mm YALITIMLI ve PANJURLU ÜST DIŞ KANAT DETAY
120mm isolation and roller with top side outer sash detail

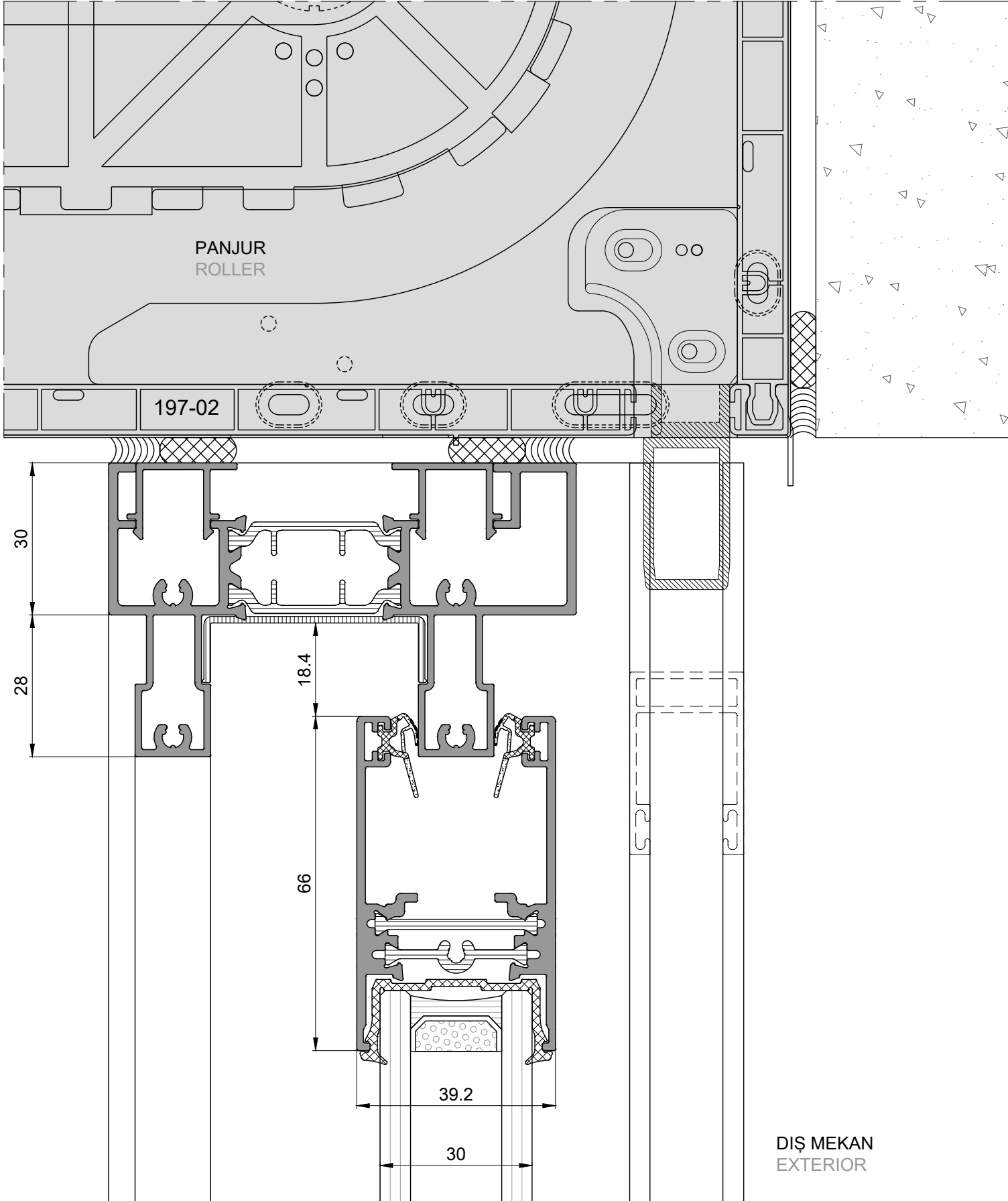
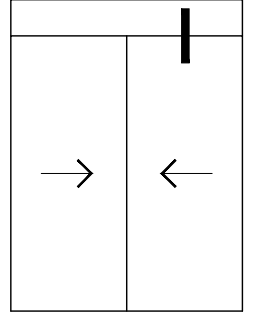

120mm YALITIMLI ve PANJURLU ALT İÇ KANAT DETAY
120mm isolation and roller with bottom side inner sash detail

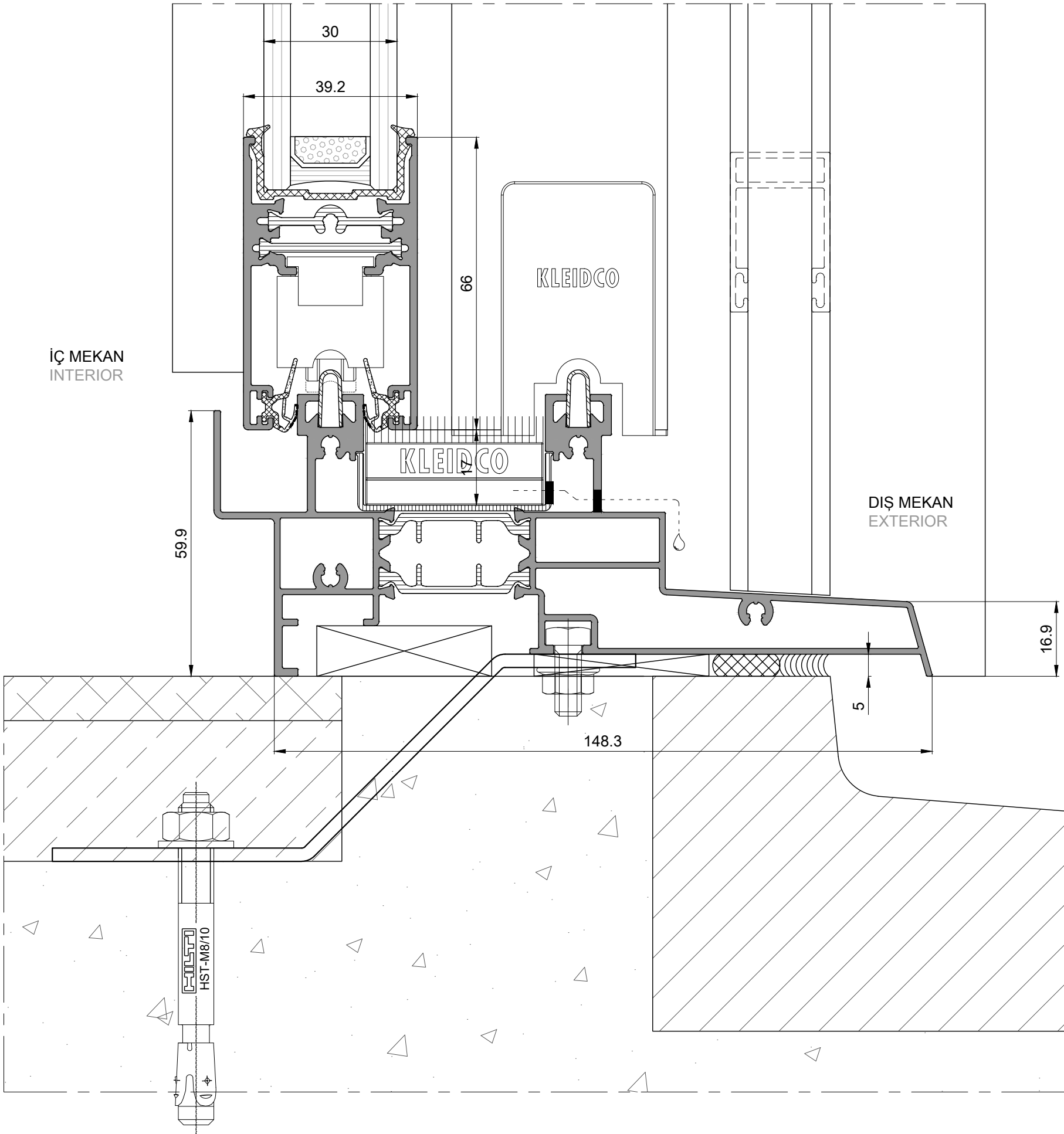
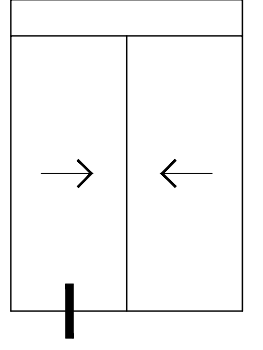

120mm YALITIMLI ve PANJURLU ALT DIŞ KANAT DETAY
120mm isolation and roller with bottom side outer sash detail

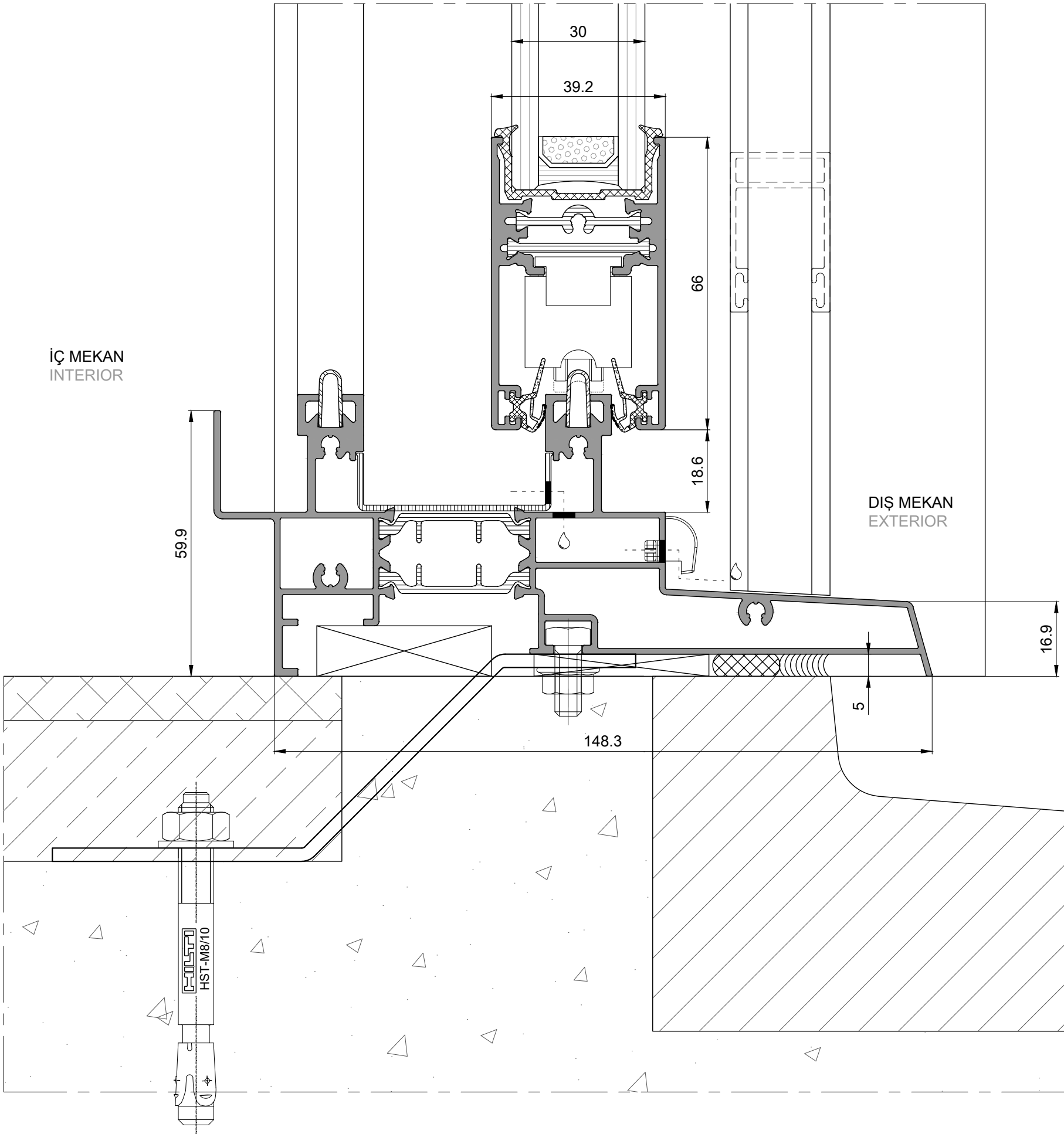
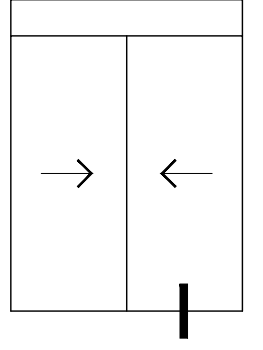

MOTIONslide
SÜRME KAPI ve PENCERE SİSTEMİ
SLIDING WINDOW and DOOR SYSTEM

160mm YALITIM ve TEK RAYLI KASA DUVAR İÇİNE
GİZLİ SÜRME
PRENSİP SİSTEM DETAYLARI
PRINCIPAL SECTIONS for
160mm ISOLATION and SINGLE RAIL FRAME
GALANDAGE

160mm YALITIMLI ve TEK RAYLI KASA DUVAR İÇİNE GİZLİ KANAT DETAY
160mm isolation and single rail frame with galandage sash detail

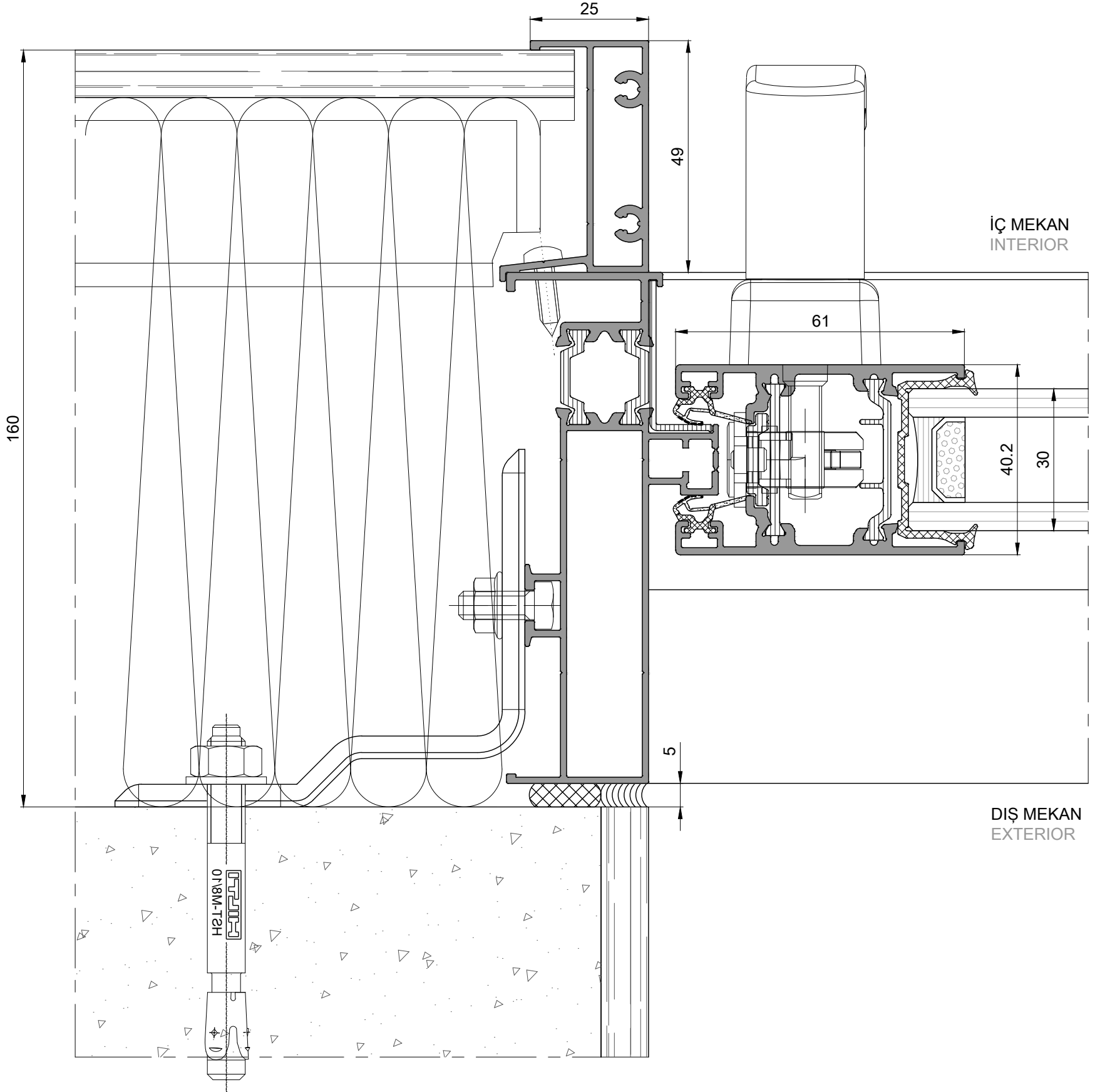
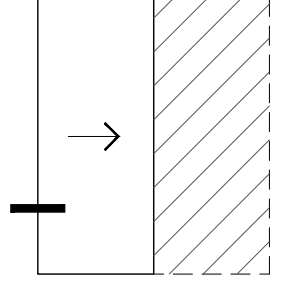

ÇİFT KANAT DETAY
double sash detail

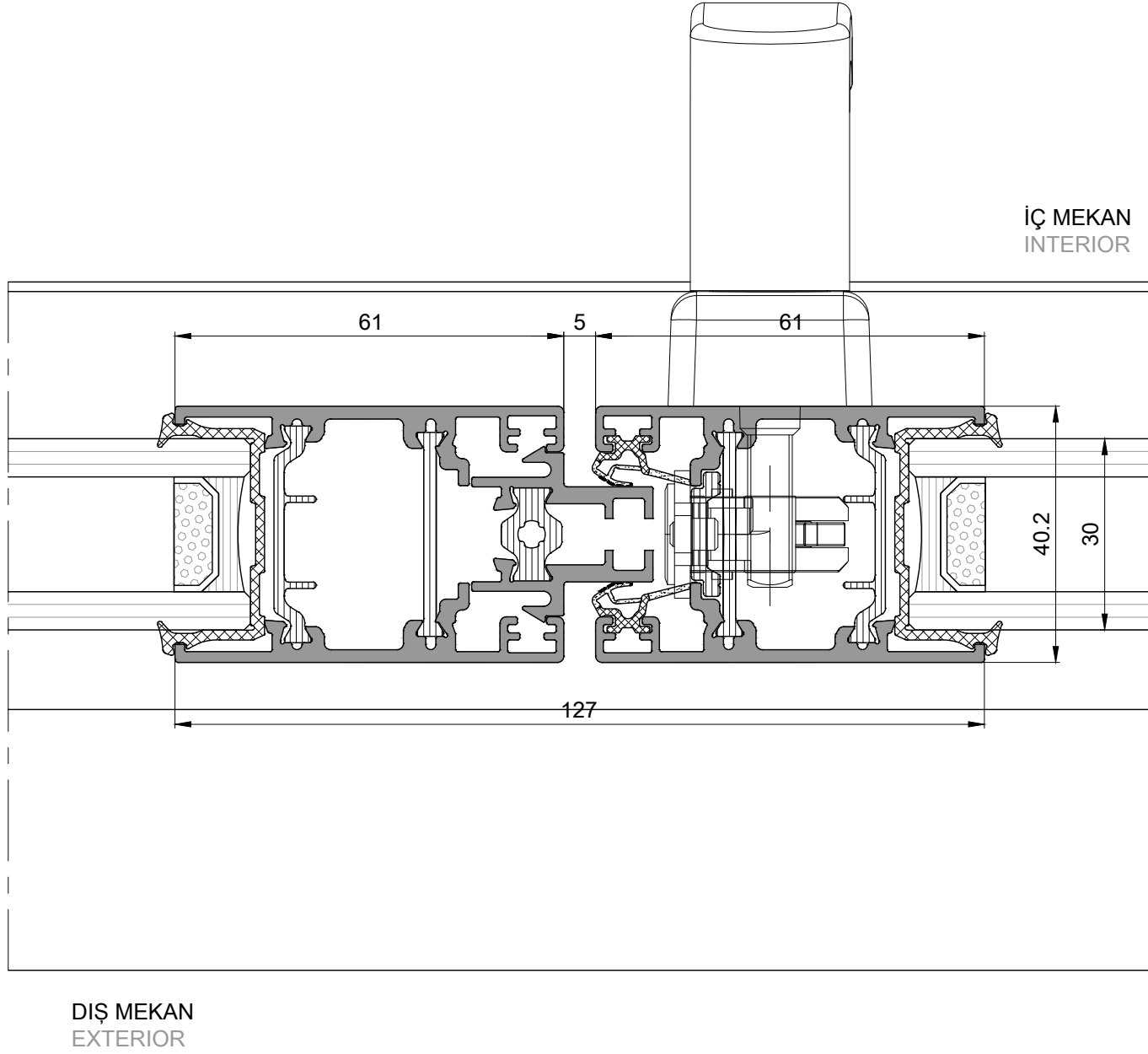
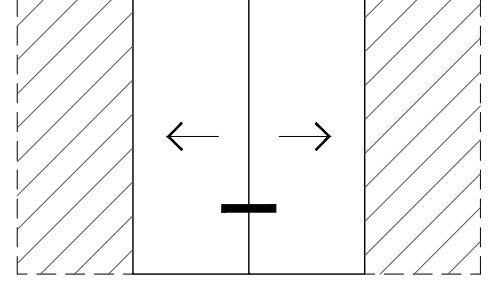

160mm YALITIMLI ve TEK RAYLI KASA DUVAR İÇİNE GİZLİ KANAT DETAY
160mm isolation and single rail frame with galandage sash detail

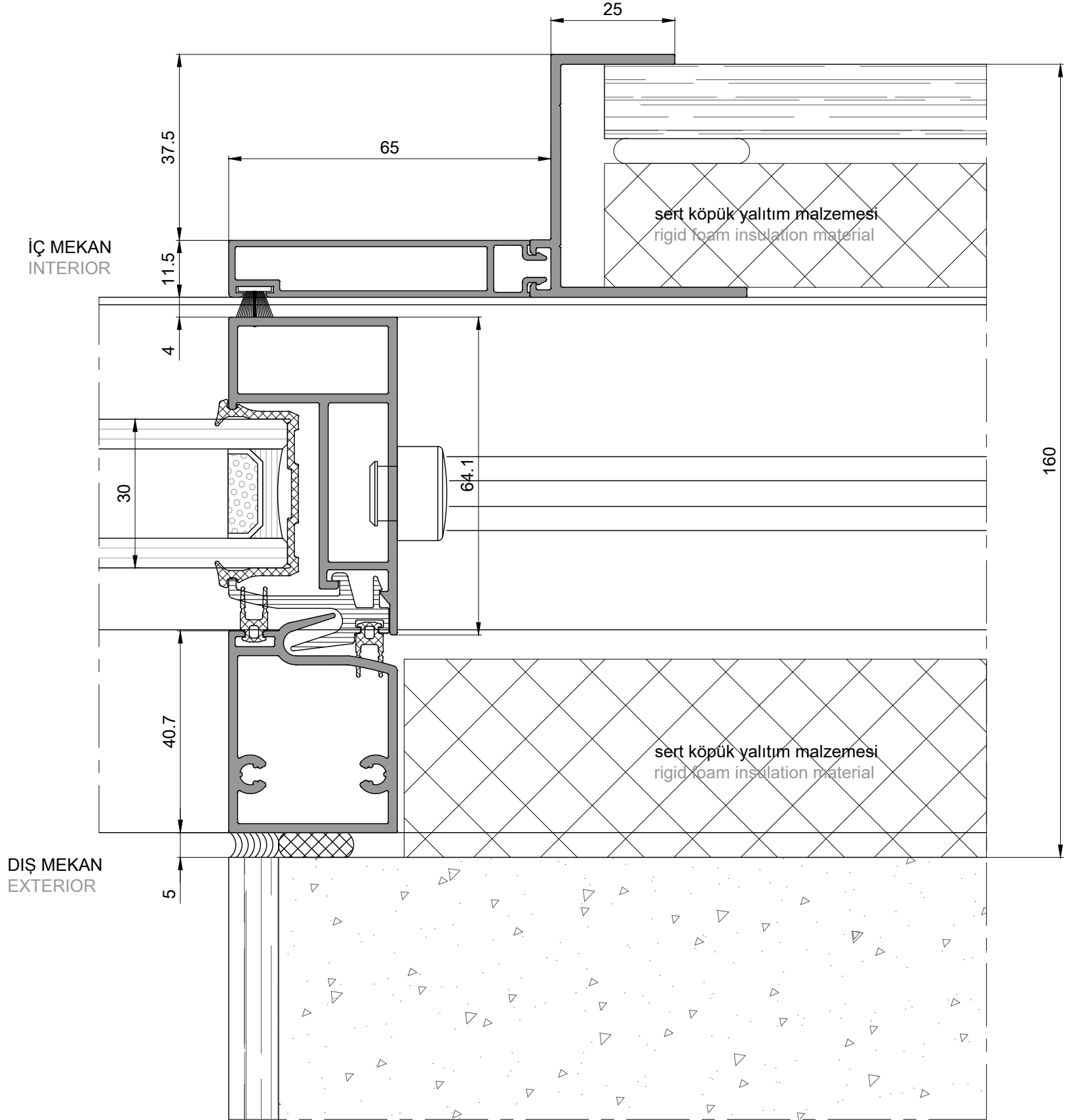
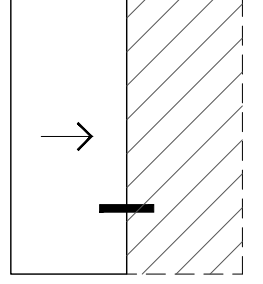

160mm YALITIMLI ve TEK RAYLI KASA DUVAR İÇİNE GİZLİ KANAT DETAY
160mm isolation and single rail frame with galandage sash detail

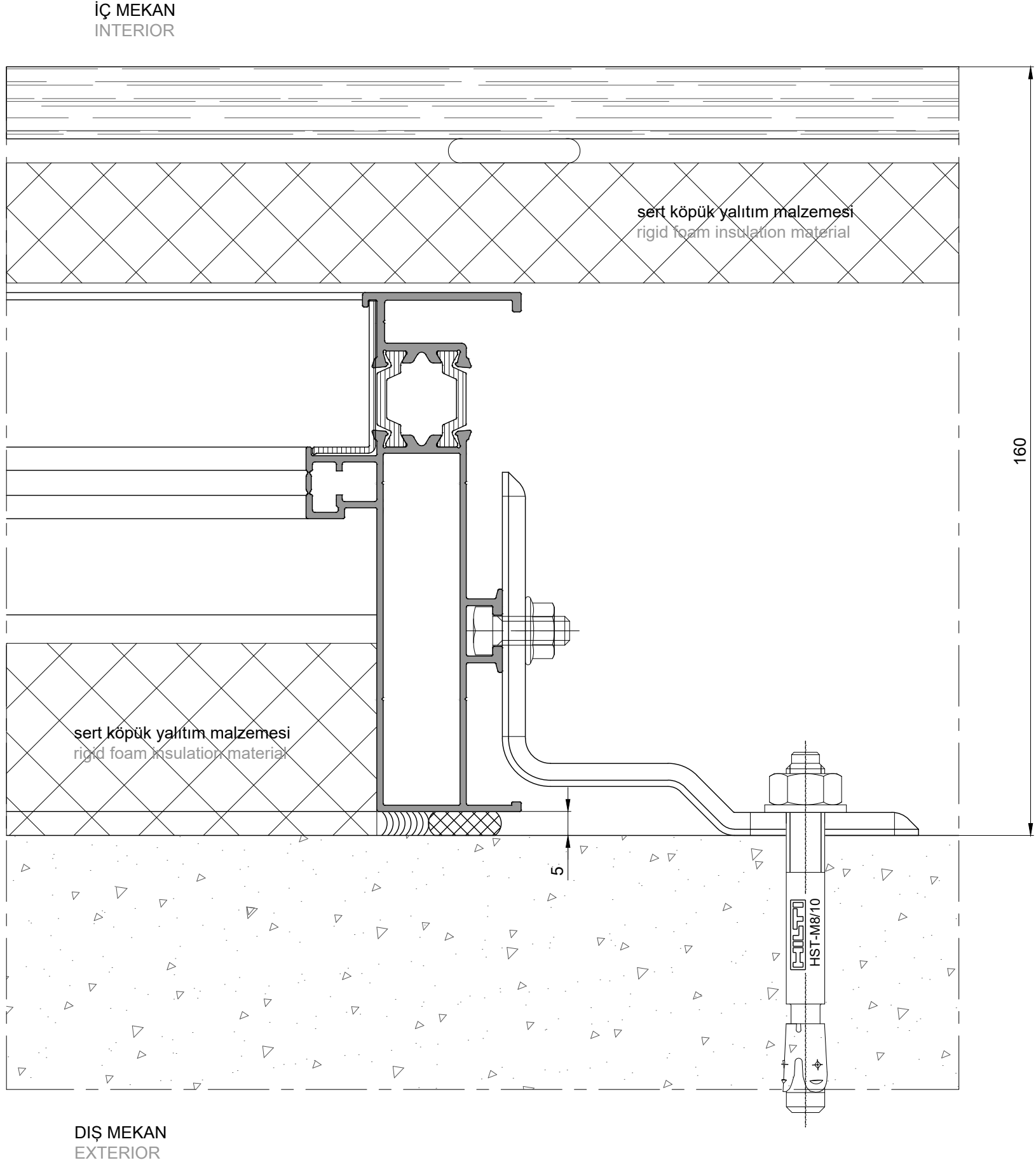
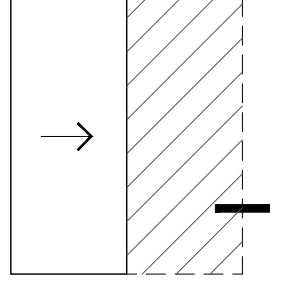

160mm YALITIMLI ve TEK RAYLI KASA DUVAR İÇİNE GİZLİ KANAT DETAY
160mm isolation and single rail frame with galandage sash detail

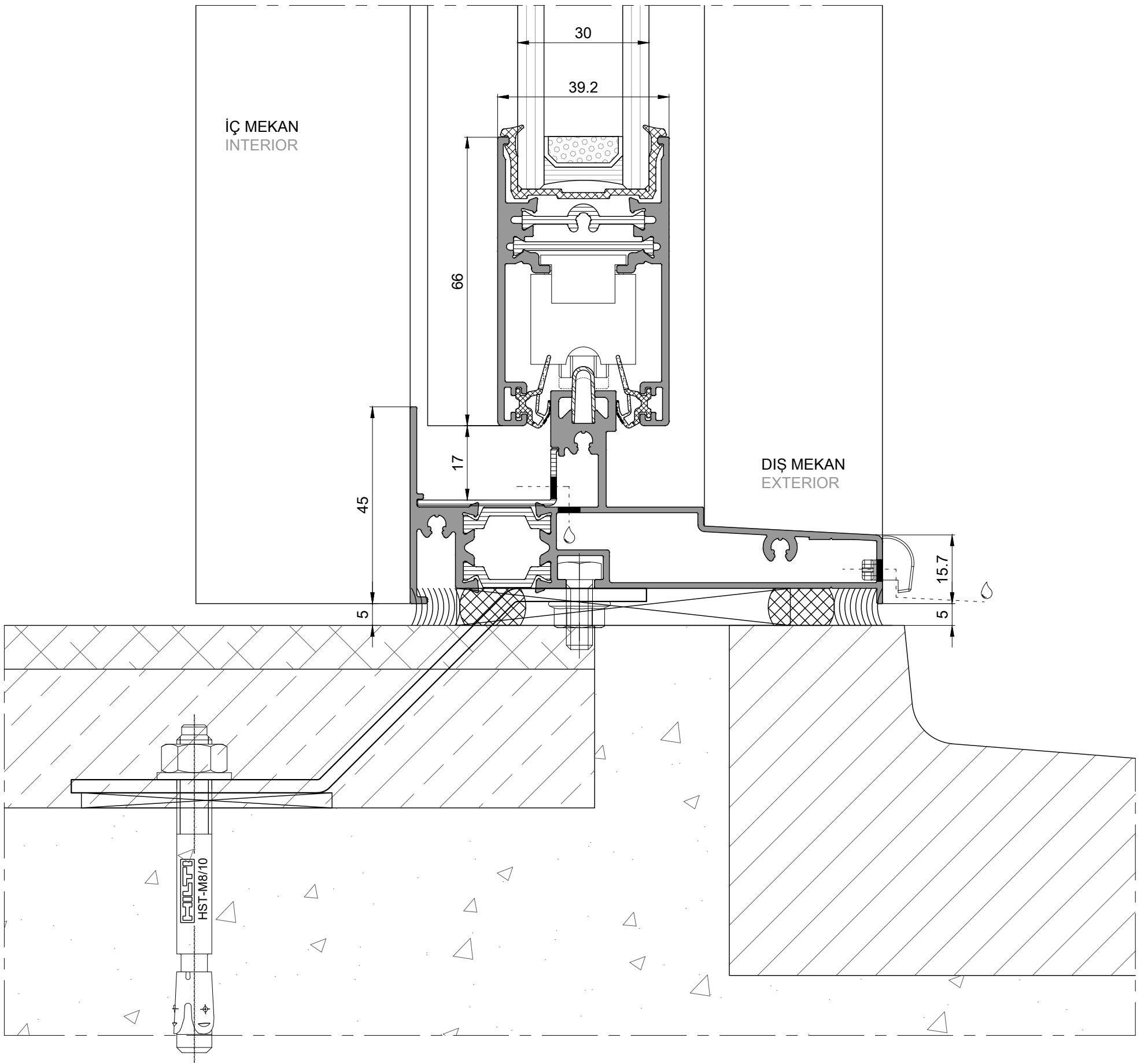
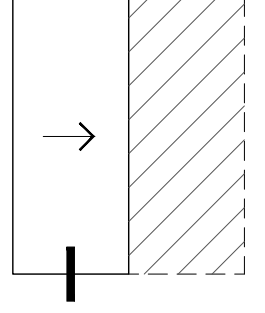

160mm YALITIMLI ve TEK RAYLI KASA DUVAR İÇİNE GİZLİ KANAT DETAY
160mm isolation and single rail frame with galandage sash detail

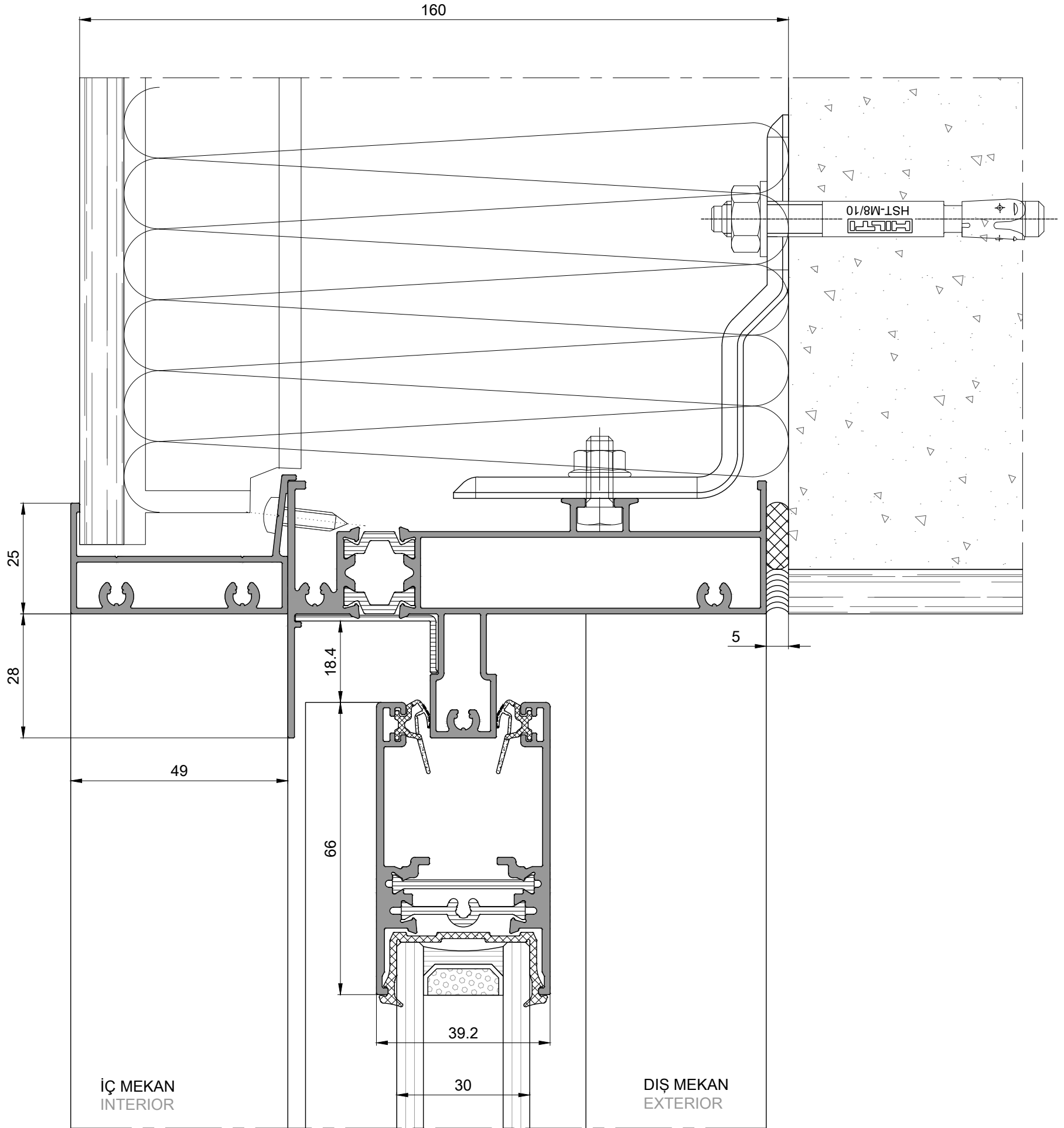
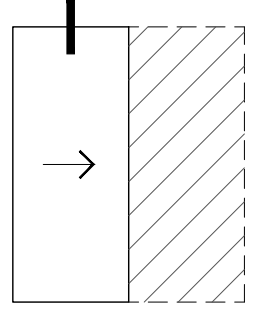

MOTIONslide
SÜRME KAPI ve PENCERE SİSTEMİ
SLIDING WINDOW and DOOR SYSTEM

200mm YALITIM ve TEK RAYLI KASA DUVAR İÇİNE
GİZLİ SÜRME
PRENSİP SİSTEM DETAYLARI
PRINCIPAL SECTIONS for
200mm ISOLATION and SINGLE RAIL FRAME
GALANDAGE

200mm YALITIMLI ve TEK RAYLI KASA DUVAR İÇİNE GİZLİ KANAT DETAY
200mm isolation and single rail frame with galandage sash detail

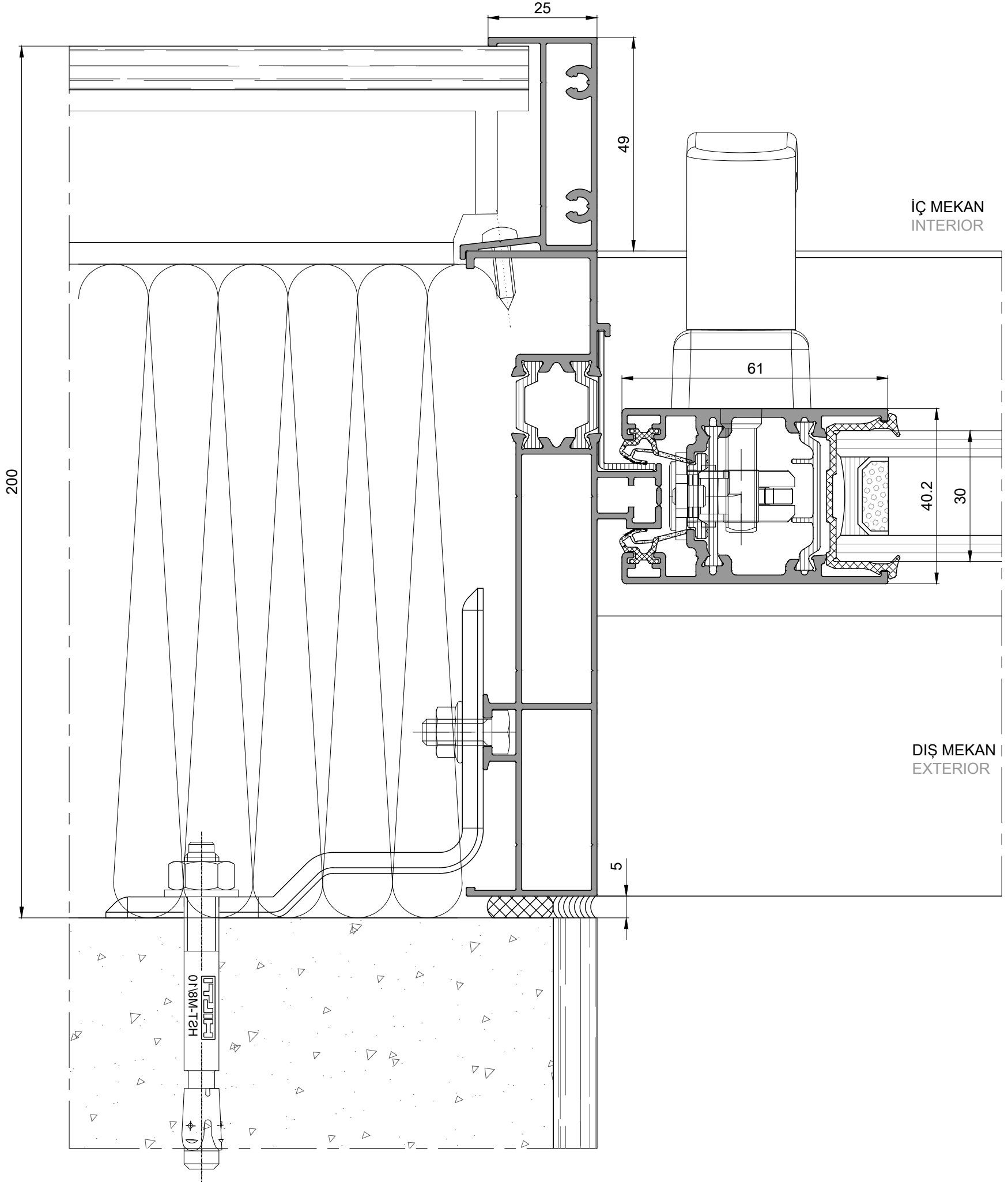
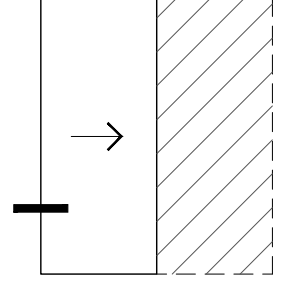

ÇİFT KANAT DETAY
double sash detail

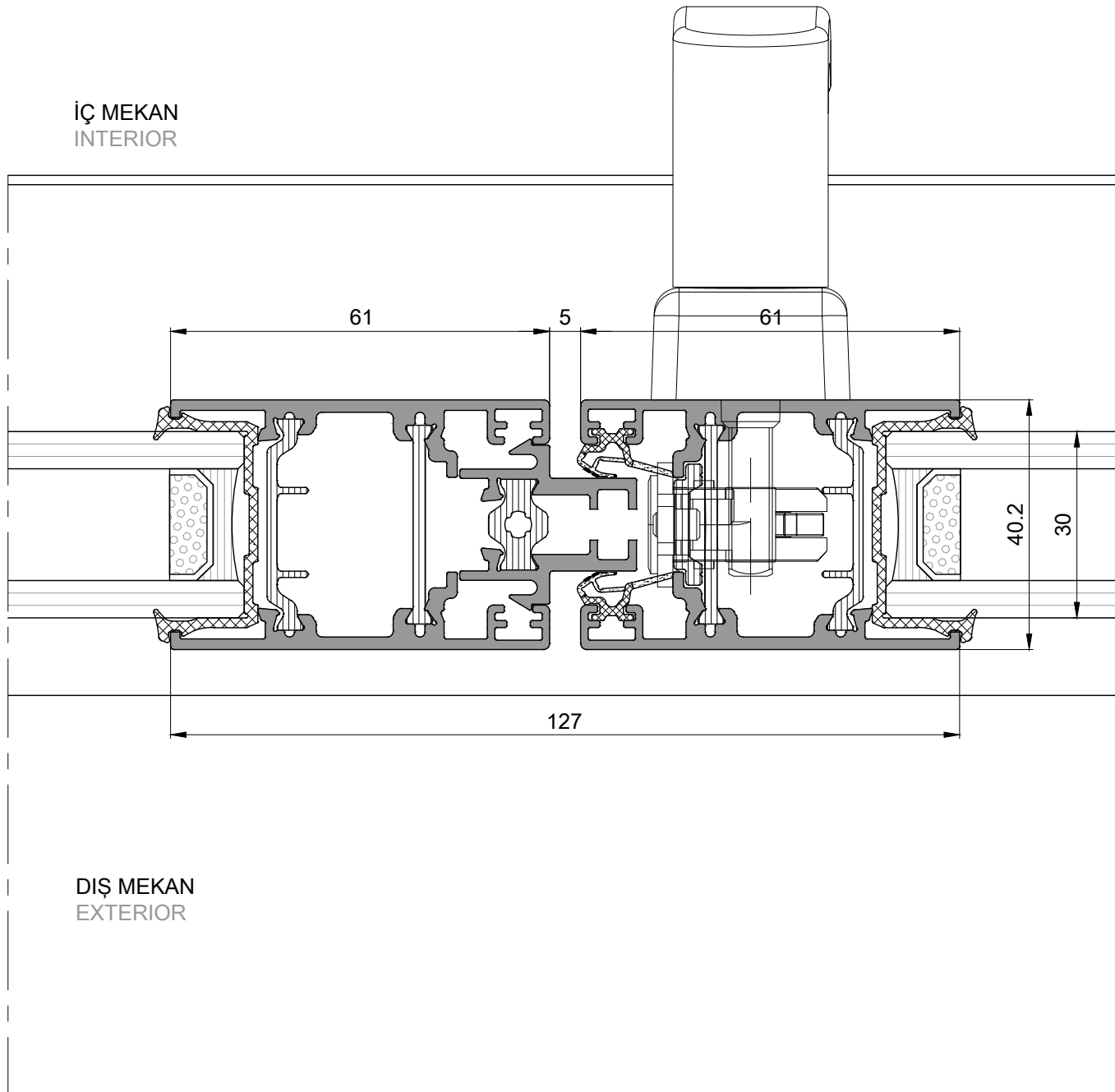
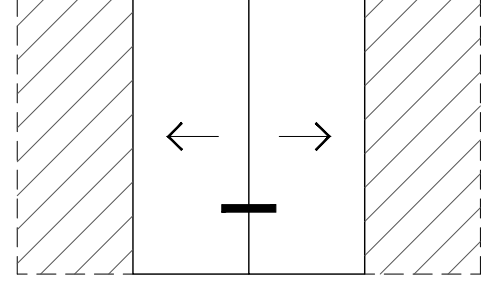

200mm YALITIMLI ve TEK RAYLI KASA DUVAR İÇİNE GİZLİ KANAT DETAY
200mm isolation and single rail frame with galandage sash detail

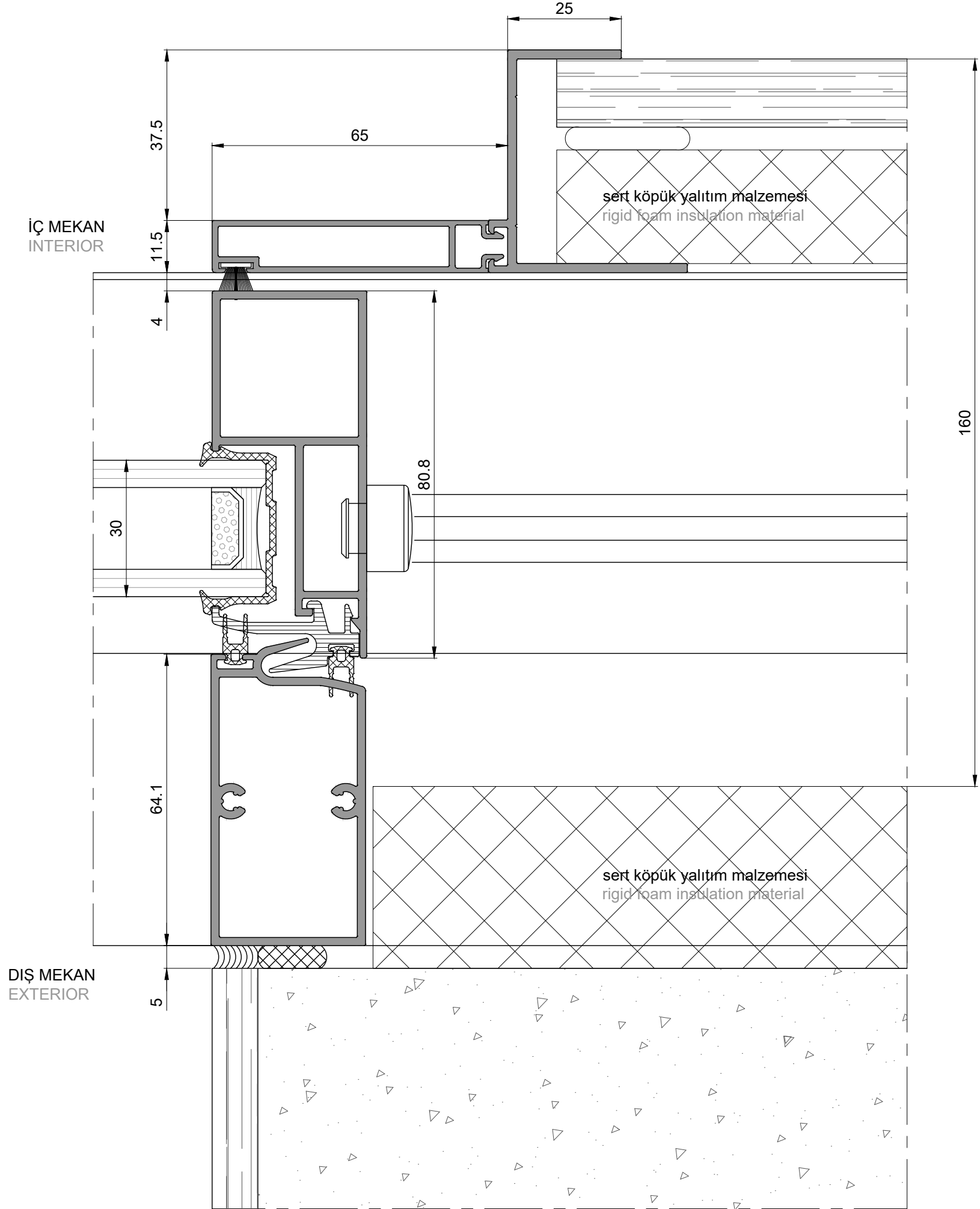
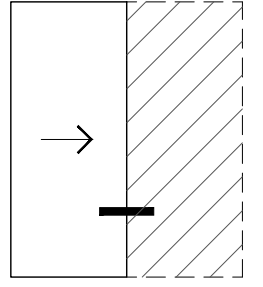

200mm YALITIMLI ve TEK RAYLI KASA DUVAR İÇİNE GİZLİ KANAT DETAY
200mm isolation and single rail frame with galandage sash detail

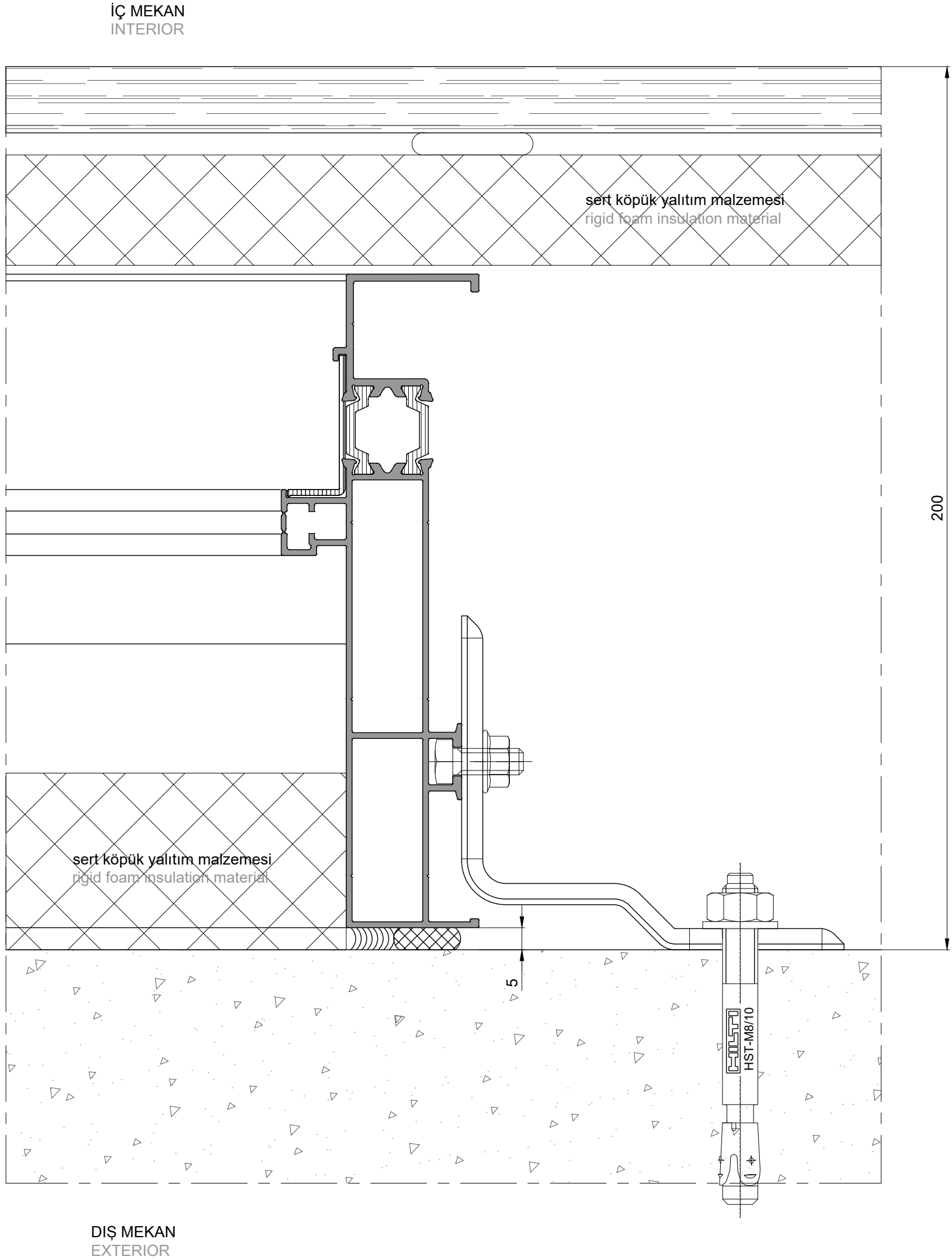
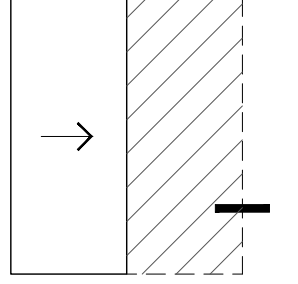

200mm YALITIMLI ve TEK RAYLI KASA DUVAR İÇİNE GİZLİ KANAT DETAY
200mm isolation and single rail frame with galandage sash detail

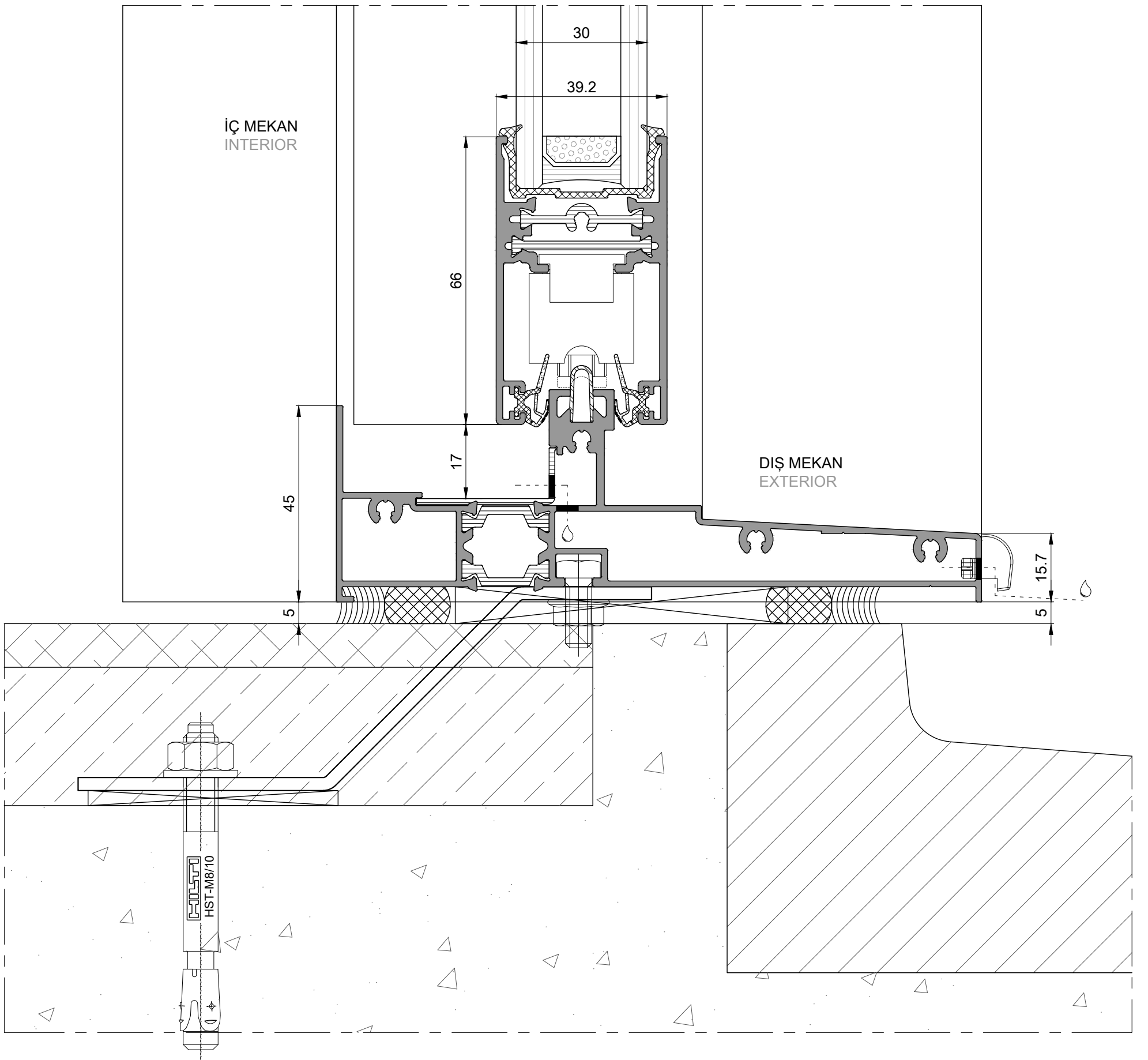
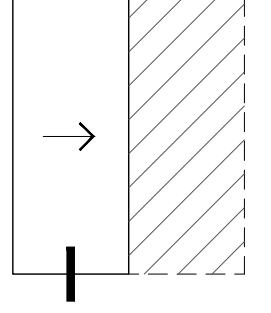

200mm YALITIMLI ve TEK RAYLI KASA DUVAR İÇİNE GİZLİ KANAT DETAY
200mm isolation and single rail frame with galandage sash detail

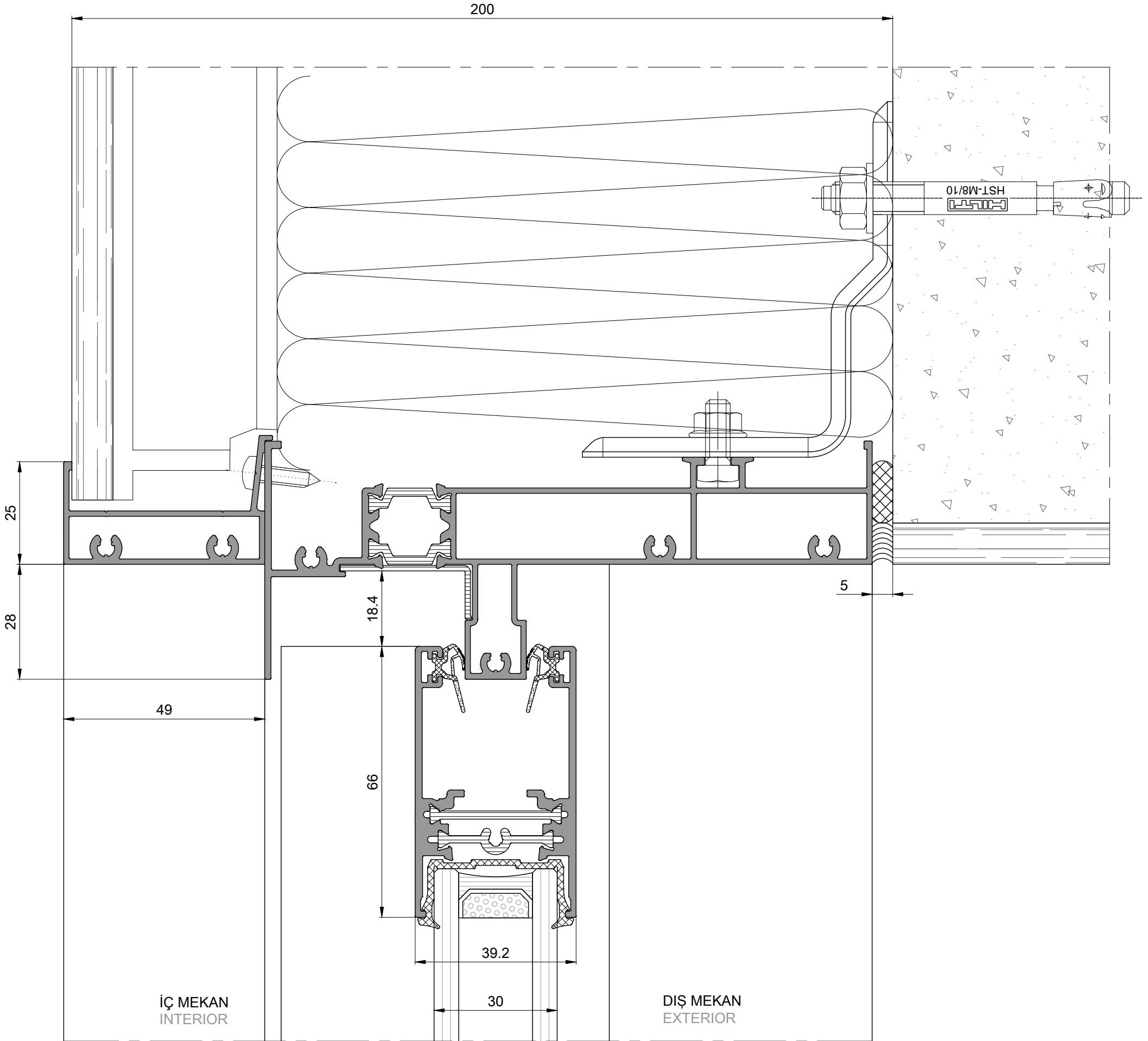
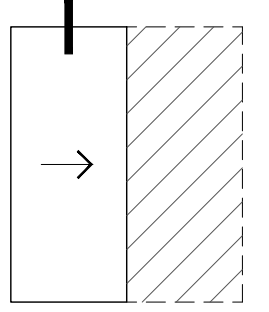

MOTIONslide
SÜRME KAPI ve PENCERE SİSTEMİ
SLIDING WINDOW and DOOR SYSTEM

200mm YALITIM ve ÇİFT RAYLI KASA DUVAR İÇİNE
GİZLİ SÜRME
PRENSİP SİSTEM DETAYLARI
PRINCIPAL SECTIONS for
200mm ISOLATION and DOUBLE RAIL FRAME
GALANDAGE

200mm YALITIMLI ve ÇİFT RAYLI KASA DUVAR İÇİNE GİZLİ KANAT DETAY
200mm isolation and double rail frame with galandage sash detail

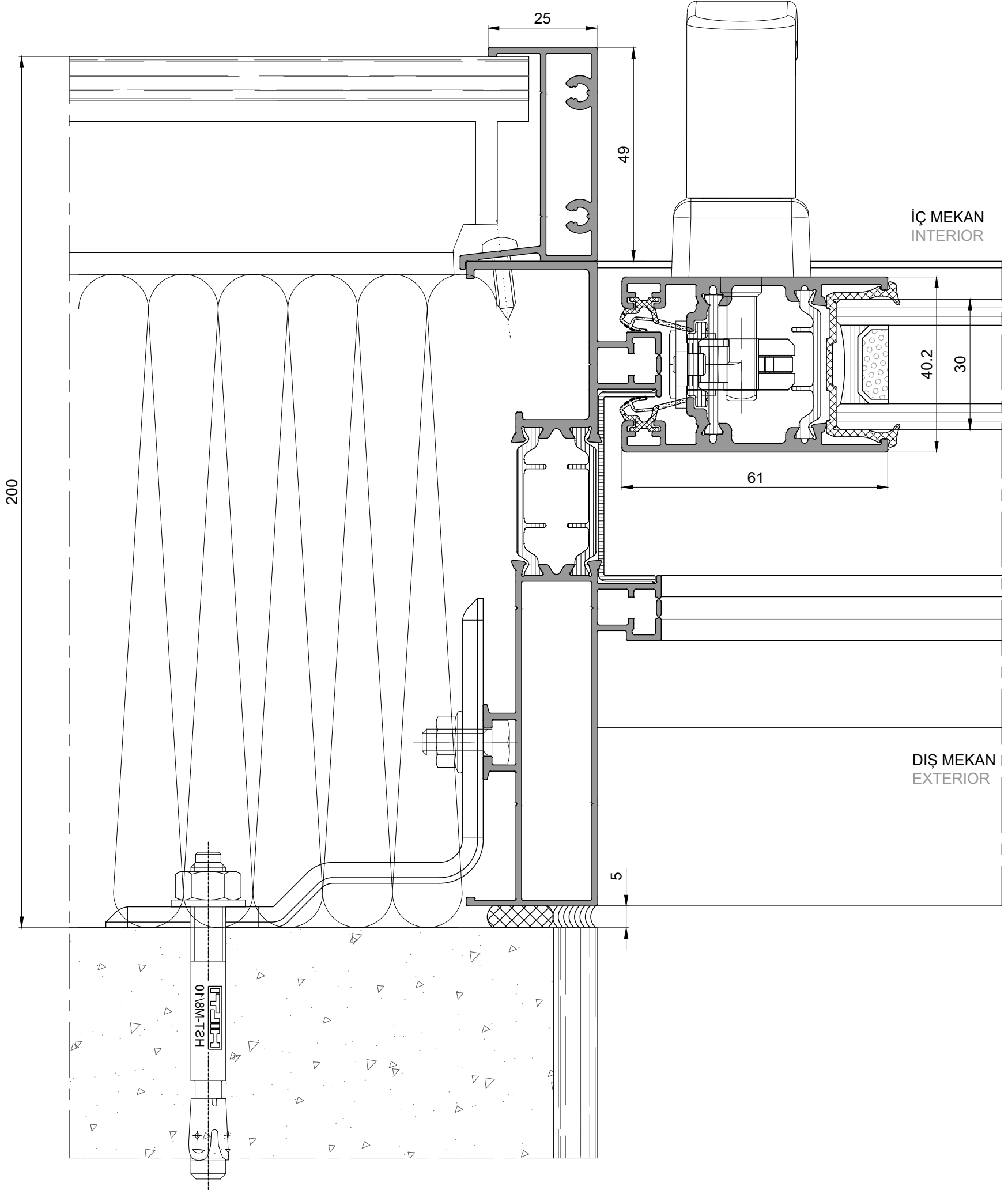
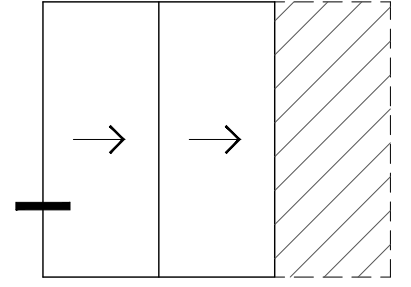

200mm YALITIMLI ve ÇİFT RAYLI KASA DUVAR İÇİNE GİZLİ KANAT DETAY
200mm isolation and double rail frame with galandage sash detail

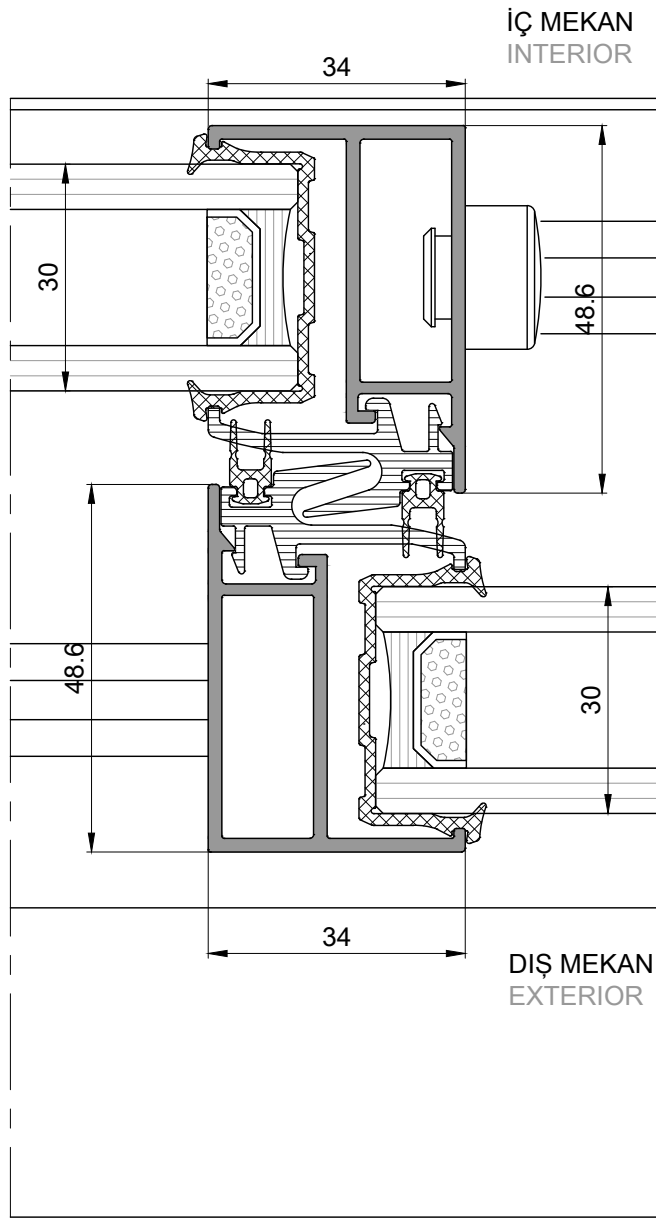
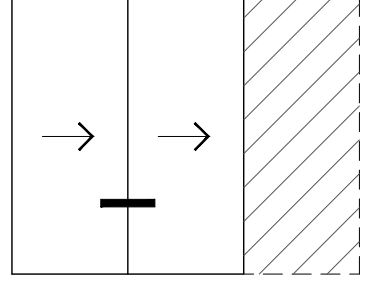

ÇİFT KANAT DETAY
double sash detail

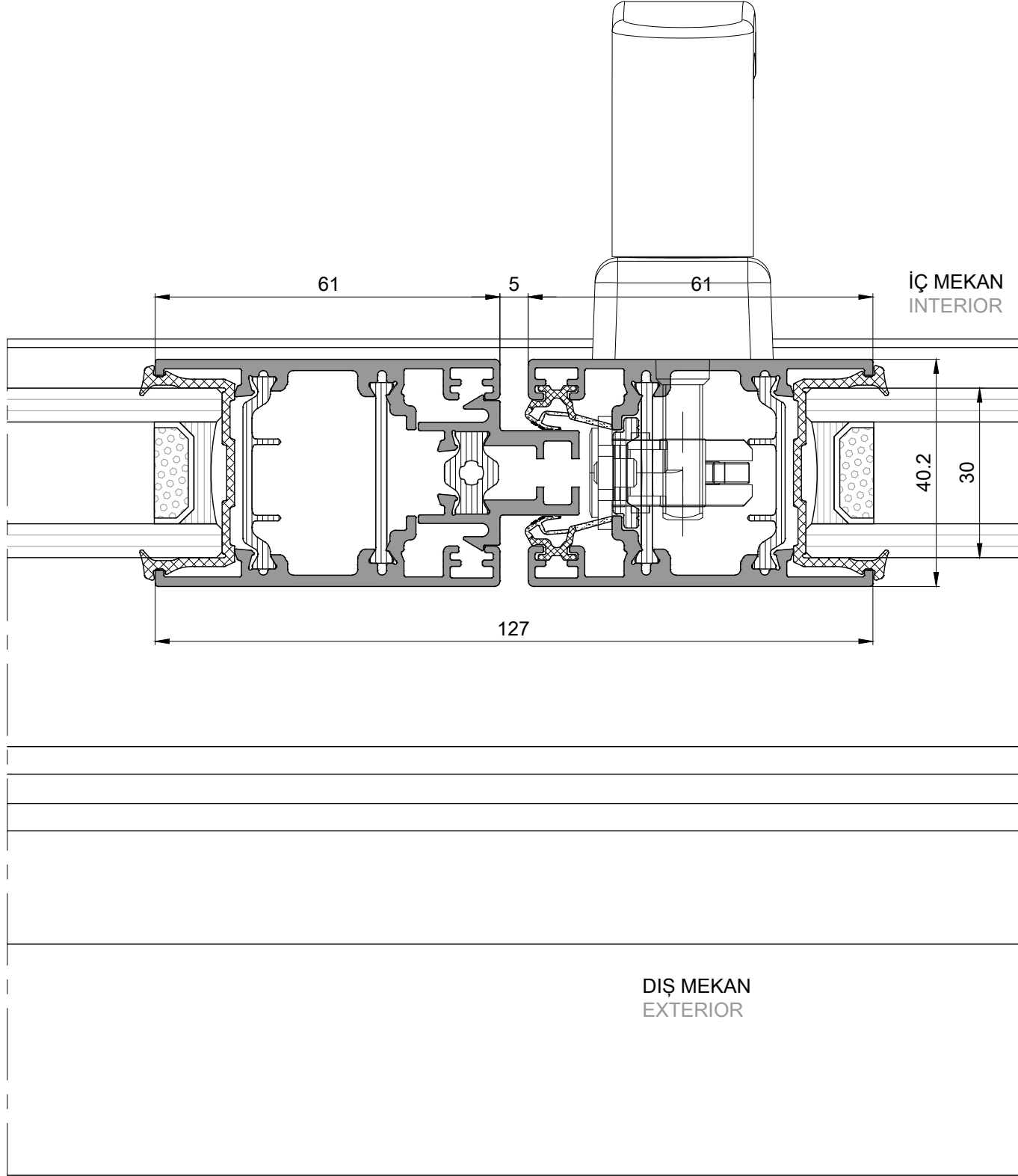
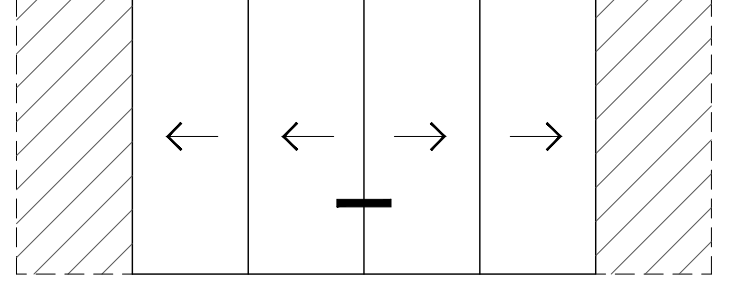

200mm YALITIMLI ve ÇİFT RAYLI KASA DUVAR İÇİNE GİZLİ KANAT DETAY
200mm isolation and double rail frame with galandage sash detail

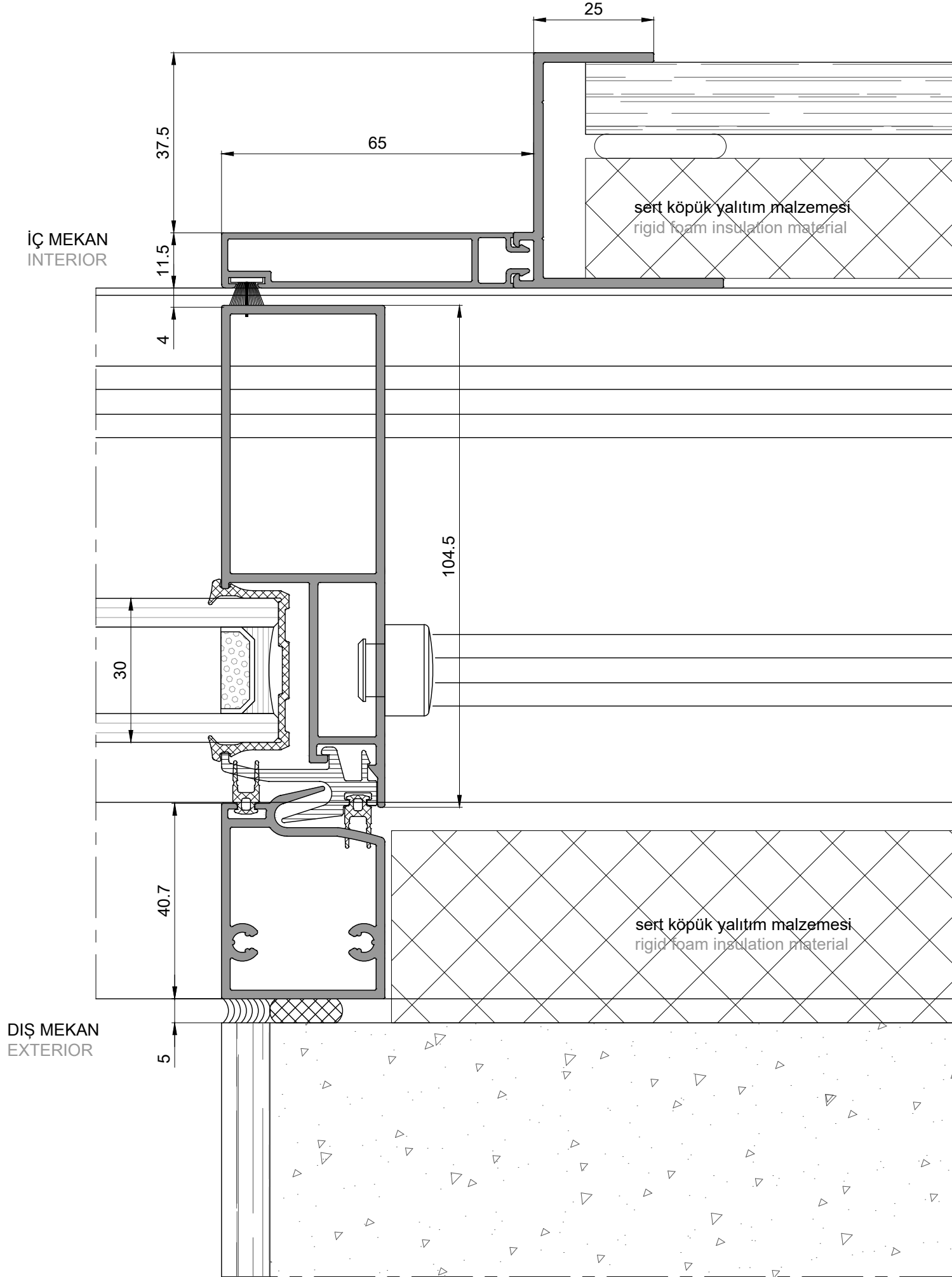
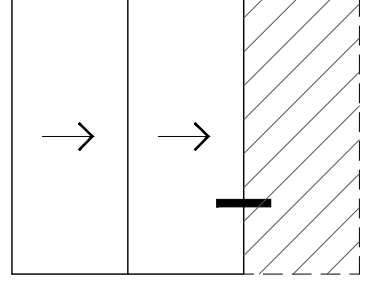

200mm YALITIMLI ve ÇİFT RAYLI KASA DUVAR İÇİNE GİZLİ KANAT DETAY
200mm isolation and double rail frame with galandage sash detail

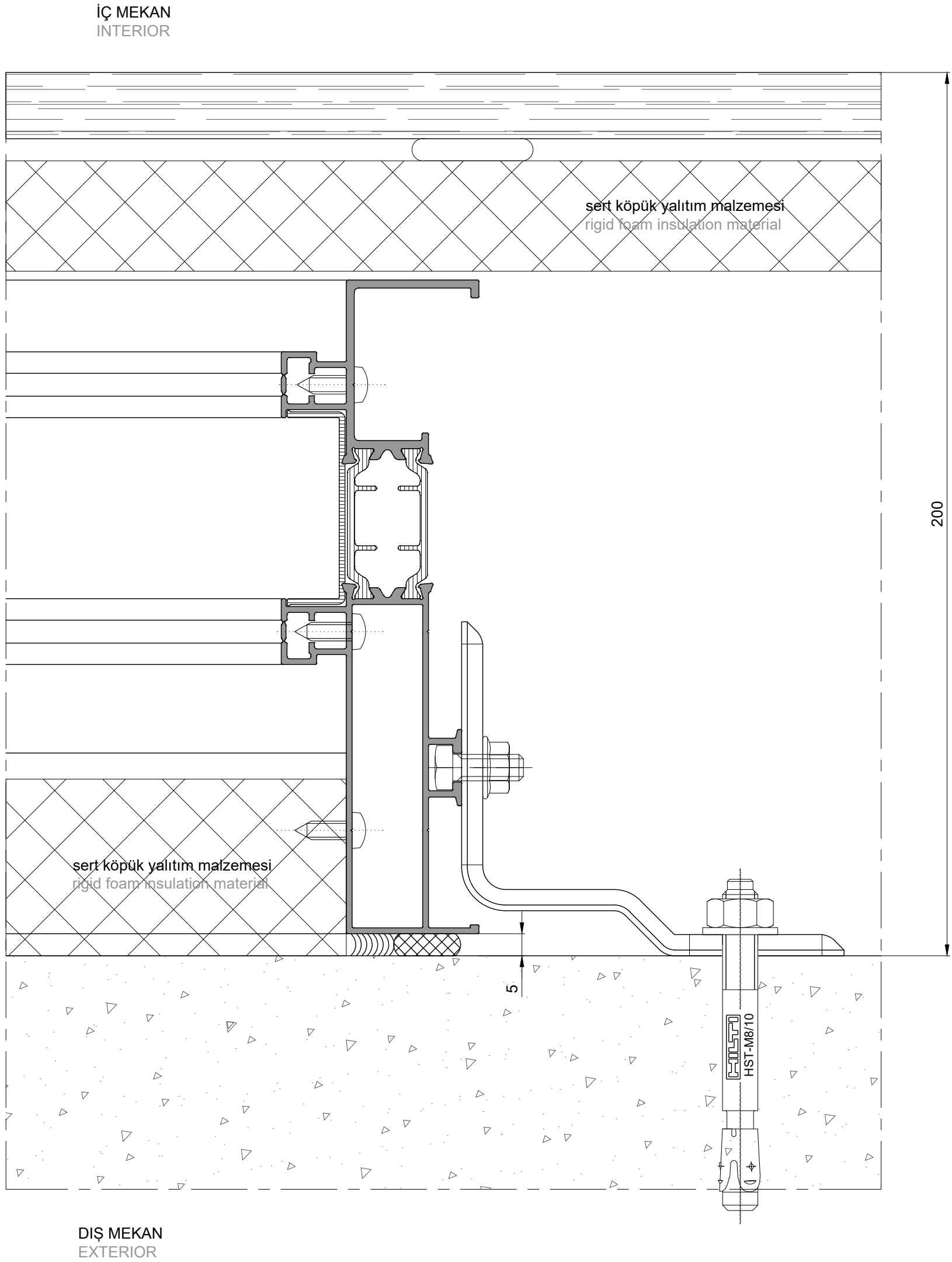
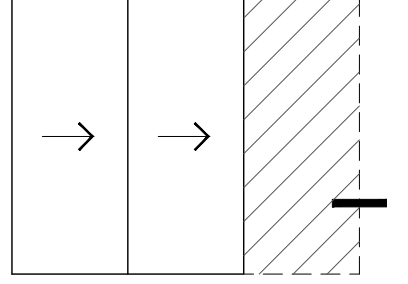

200mm YALITIMLI ve ÇİFT RAYLI KASA DUVAR İÇİNE GİZLİ KANAT DETAY
200mm isolation and double rail frame with galandage sash detail

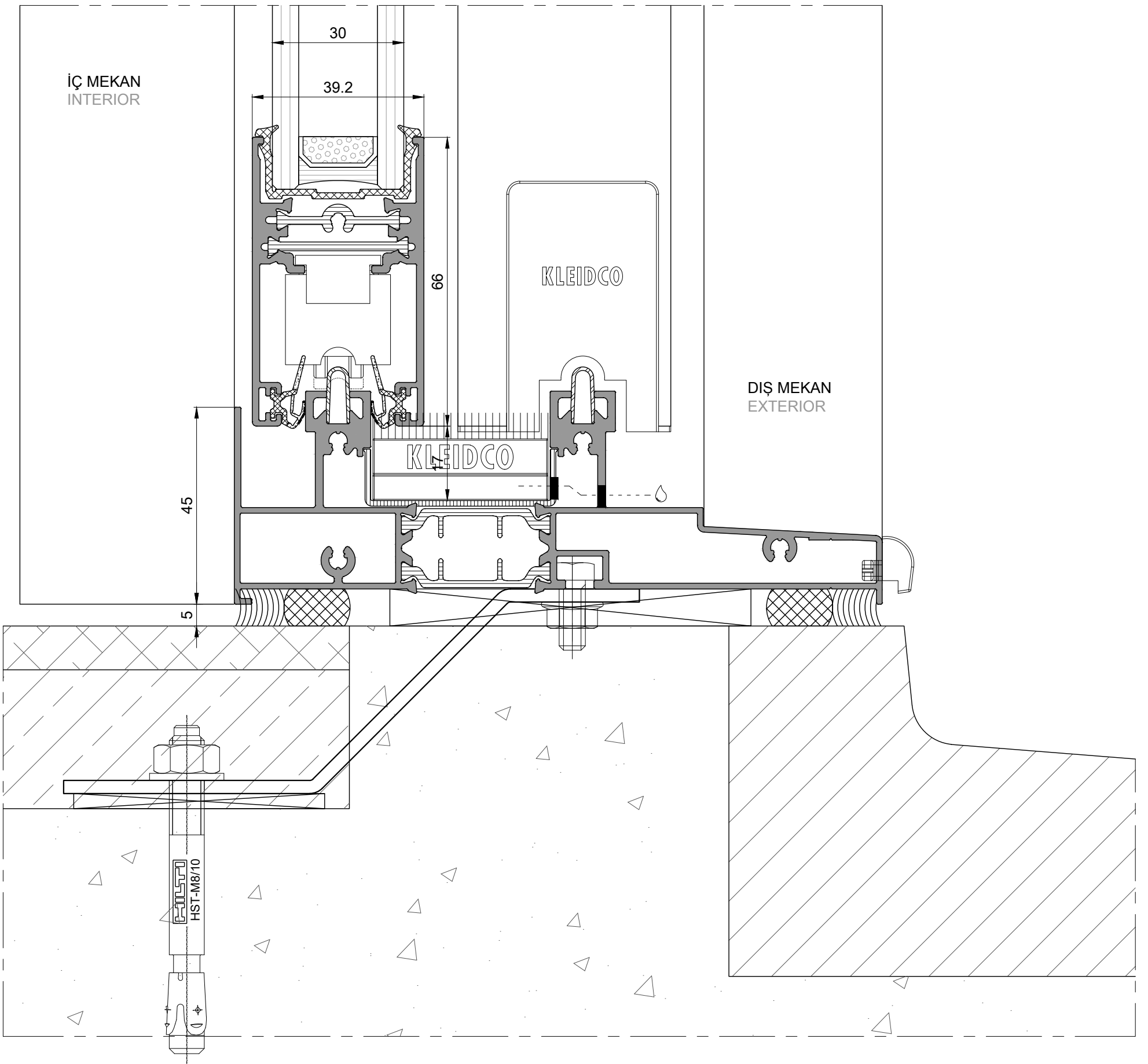
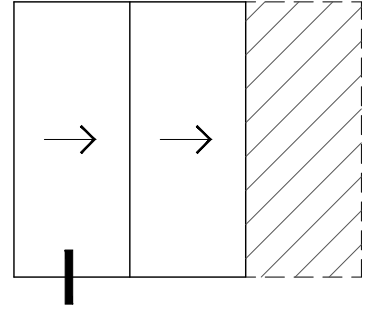

200mm YALITIMLI ve ÇİFT RAYLI KASA DUVAR İÇİNE GİZLİ KANAT DETAY
200mm isolation and double rail frame with galandage sash detail

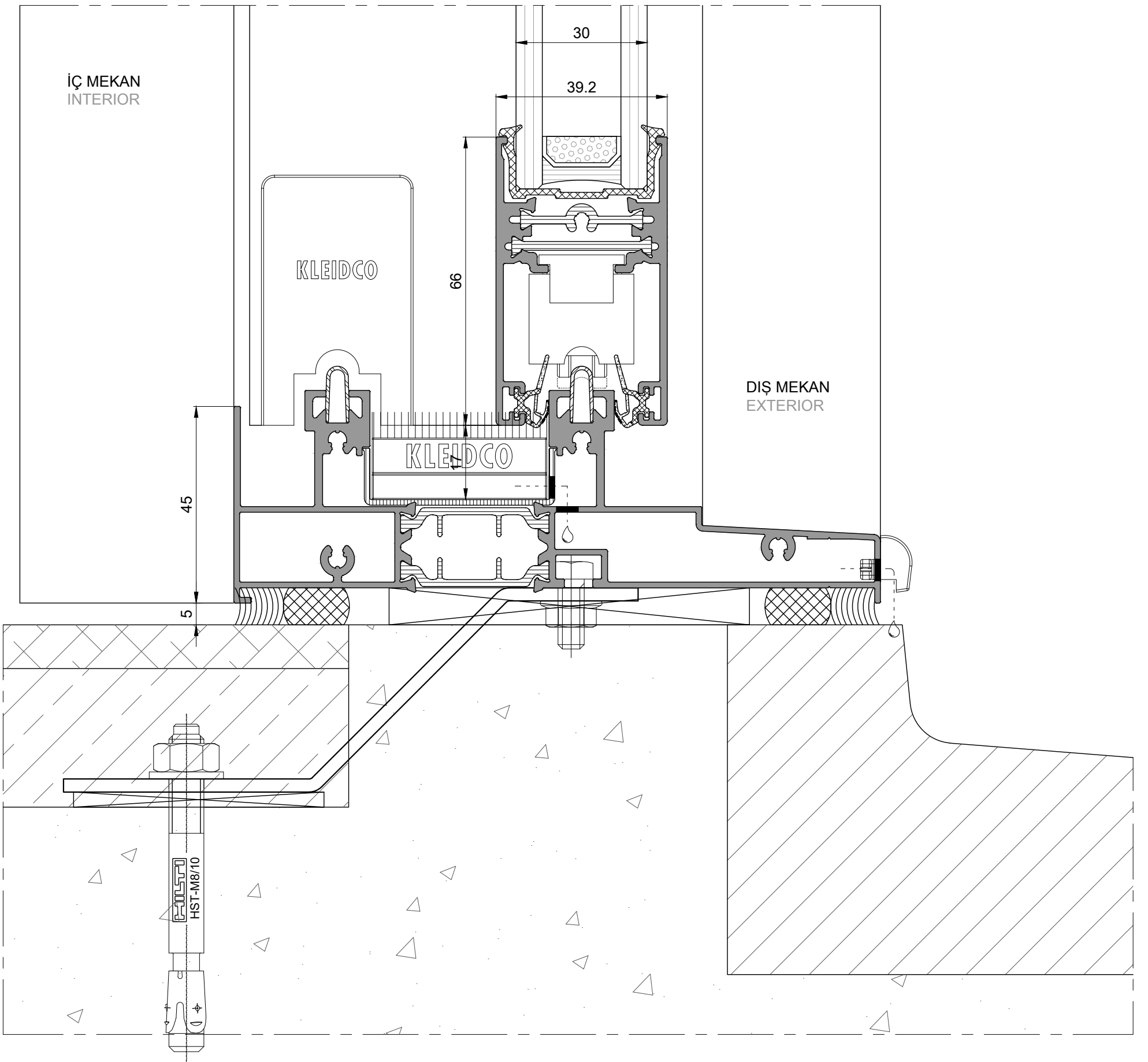
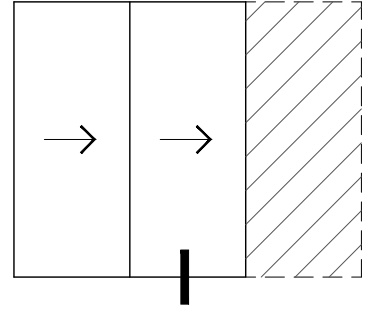

200mm YALITIMLI ve ÇİFT RAYLI KASA DUVAR İÇİNE GİZLİ KANAT DETAY
200mm isolation and double rail frame with galandage sash detail

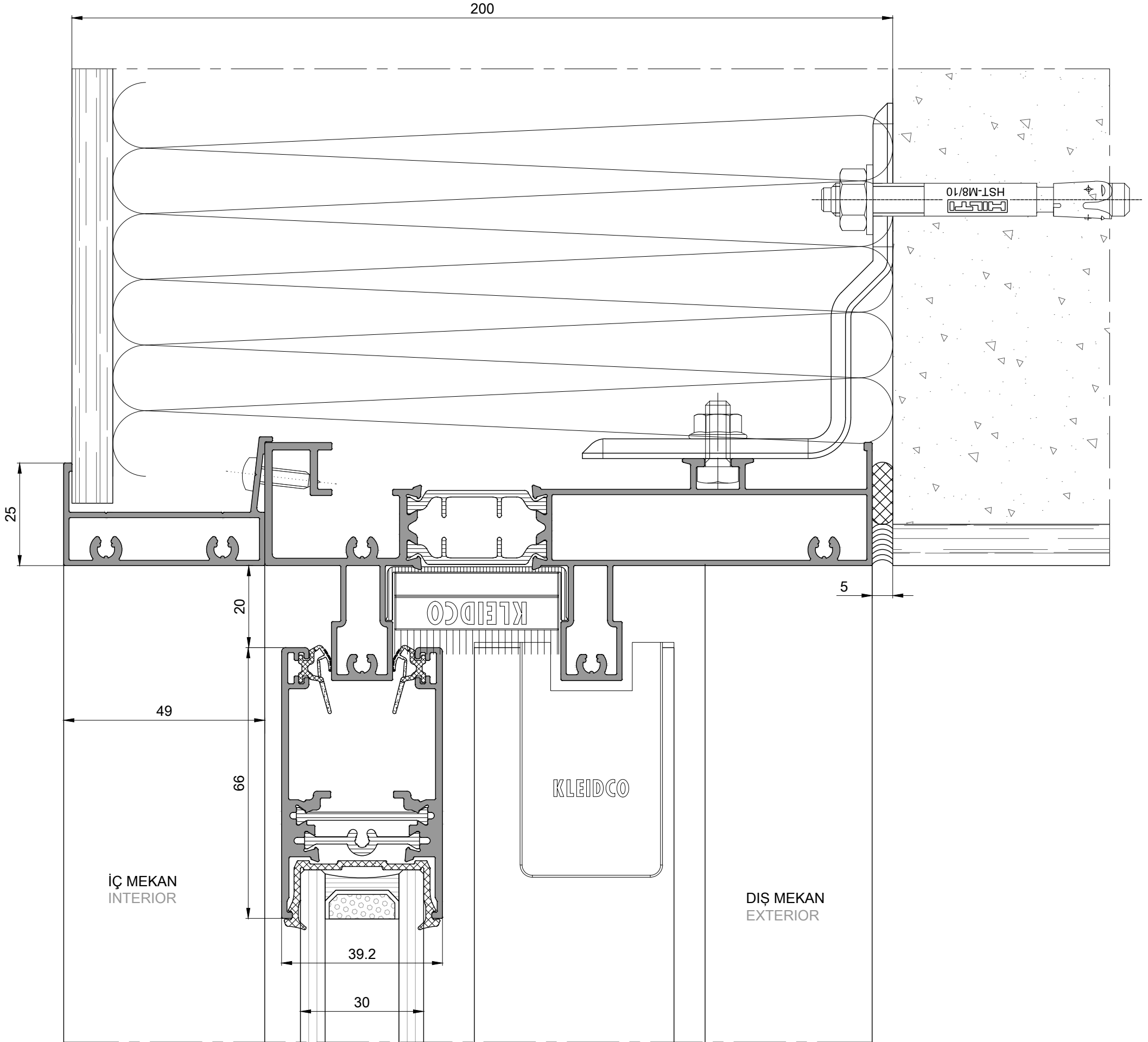
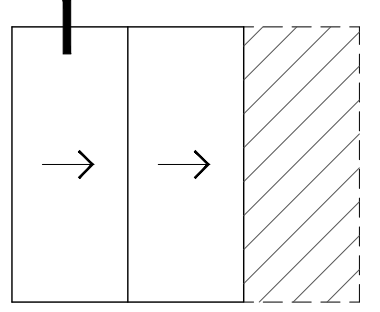

200mm YALITIMLI ve ÇİFT RAYLI KASA DUVAR İÇİNE GİZLİ KANAT DETAY
200mm isolation and double rail frame with galandage sash detail

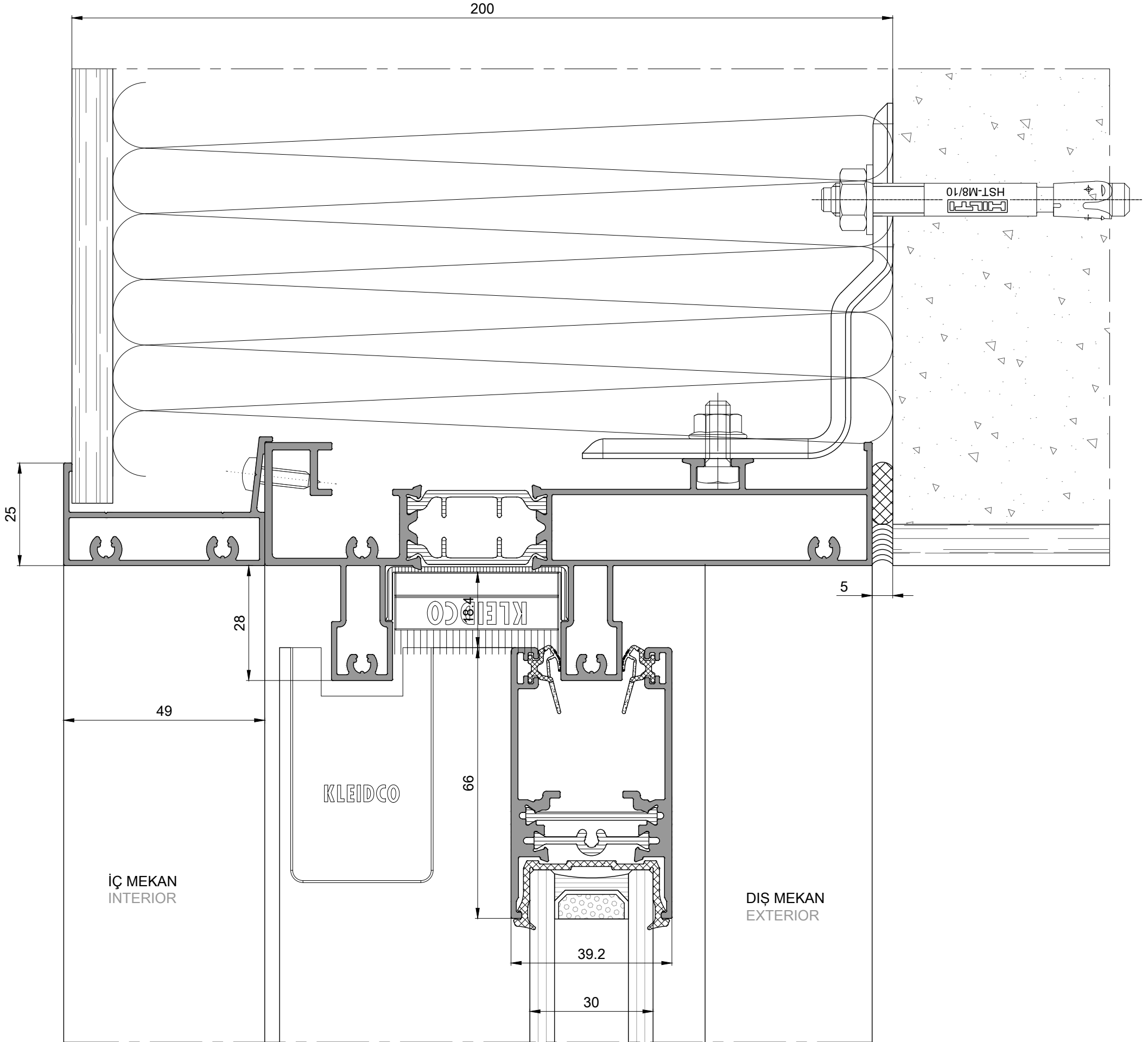
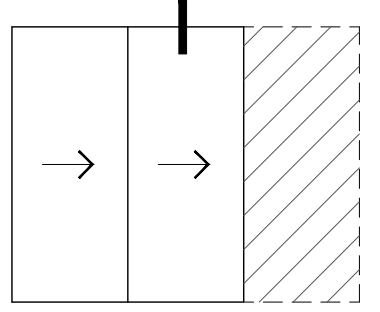

MOTIONslide
SÜRME KAPI ve PENCERE SİSTEMİ
SLIDING WINDOW and DOOR SYSTEM

ÇİFT RAYLI KASA ile YENİLEME SÜRME
PRENSİP SİSTEM DETAYLARI
PRINCIPAL SECTIONS for
RENOVATION with DOUBLE RAIL FRAME

YENİLEME YAN DETAY
Renovation left side detail

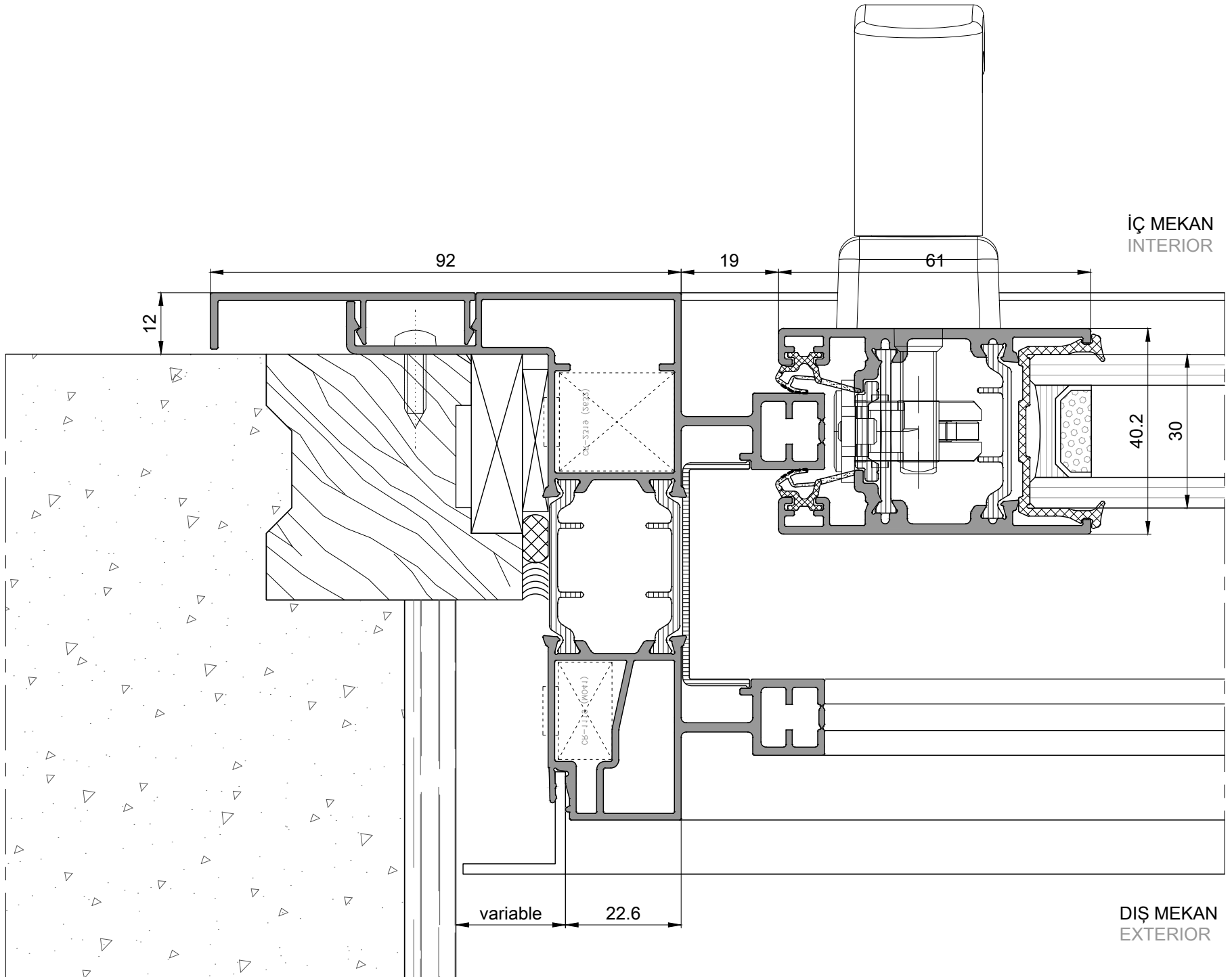
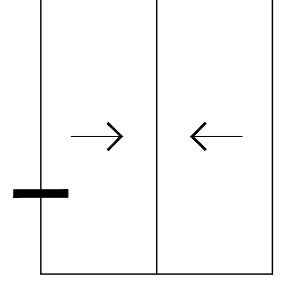

YENİLEME KENET DETAY
Renovation interlock detail

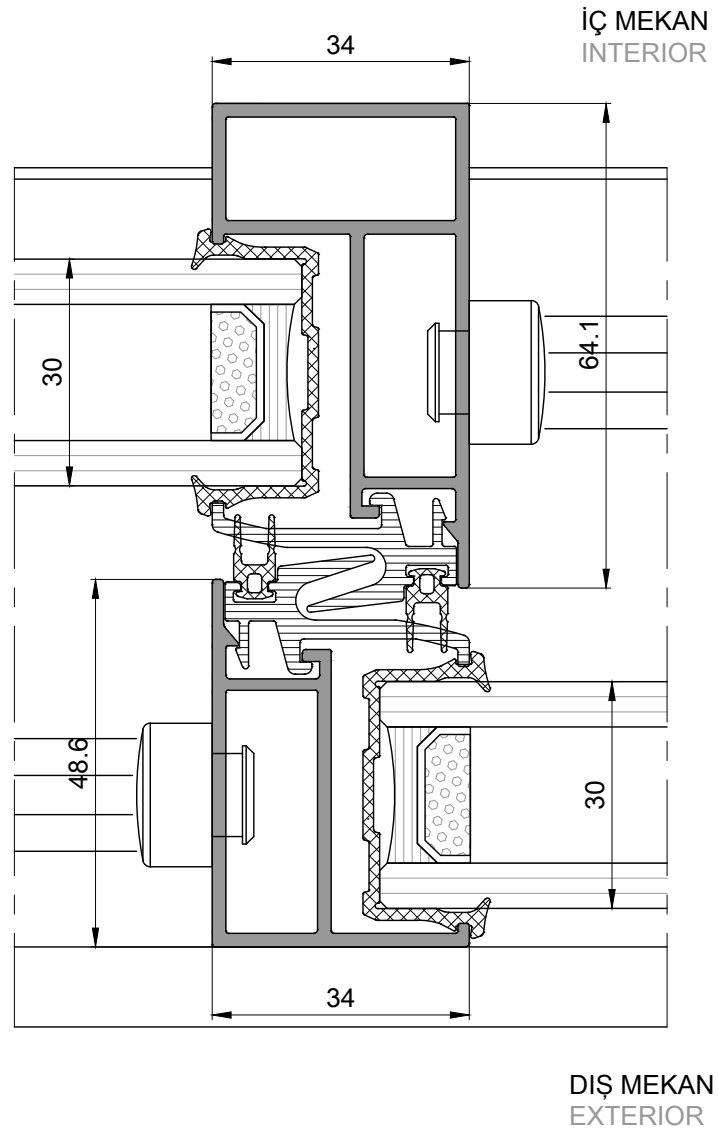
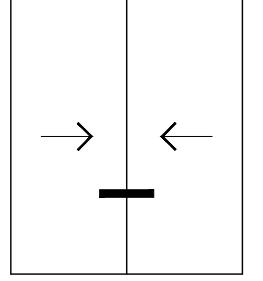

YENİLEME ÇİFT KANAT DETAY
Renovation double sash detail

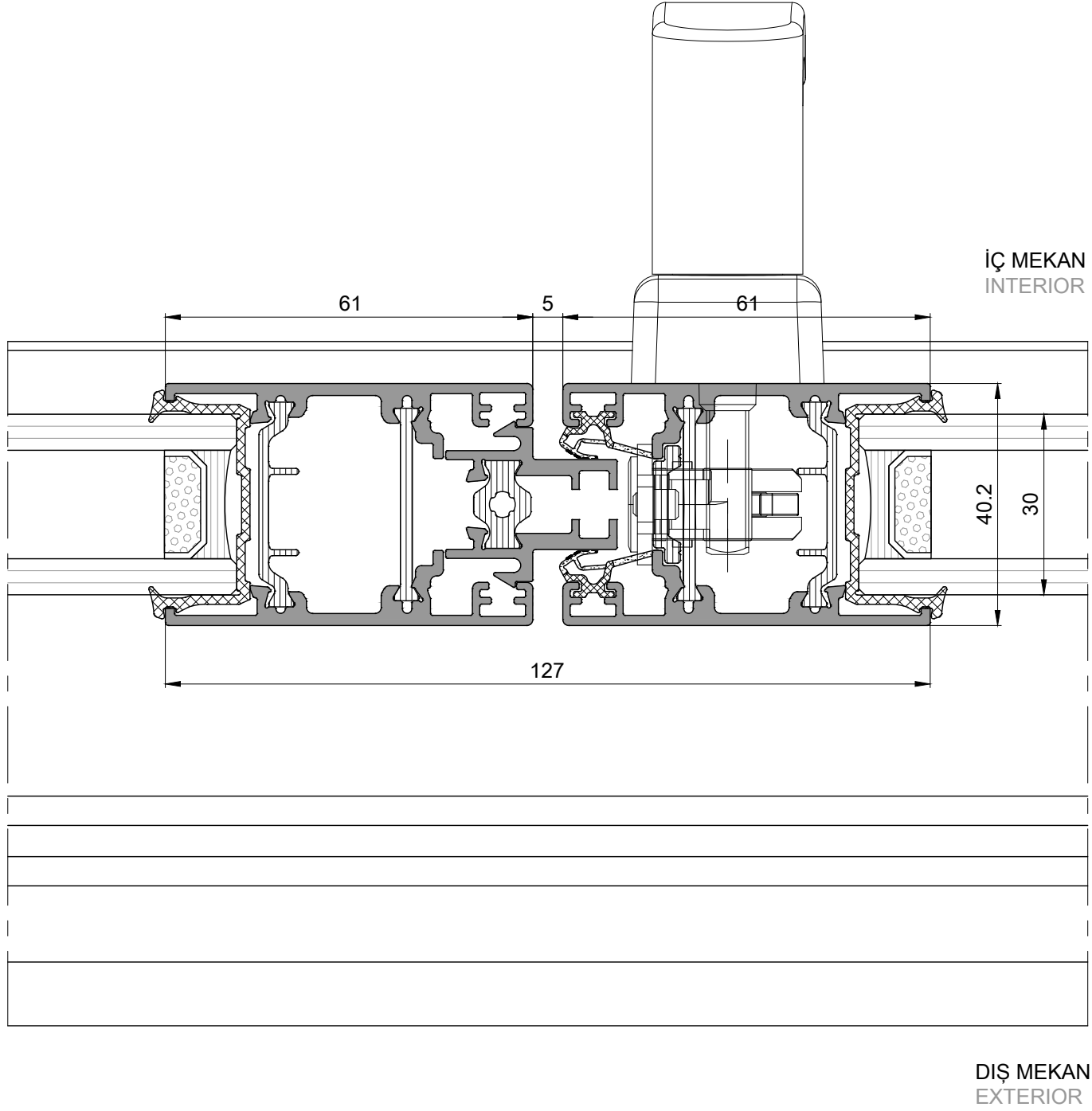
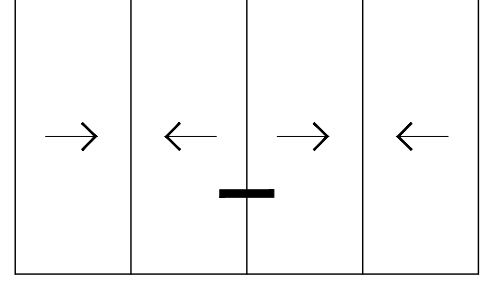

YENİLEME YAN DETAY
Renovation left side detail

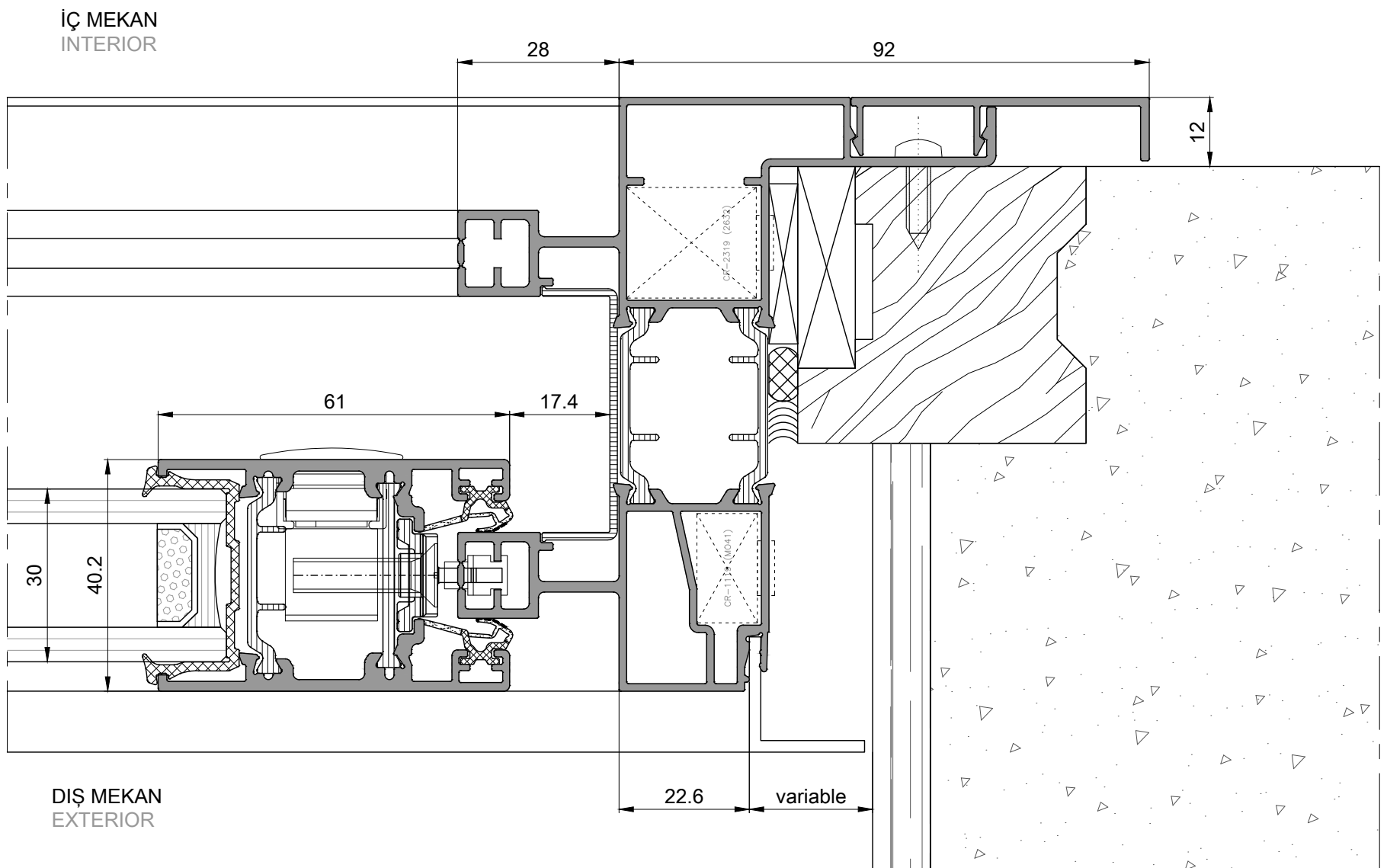
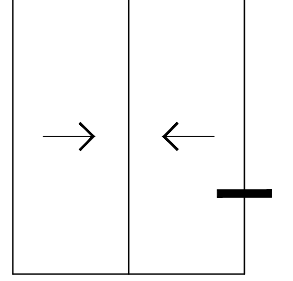

YENİLEME ÜST DETAY
Renovation top detail

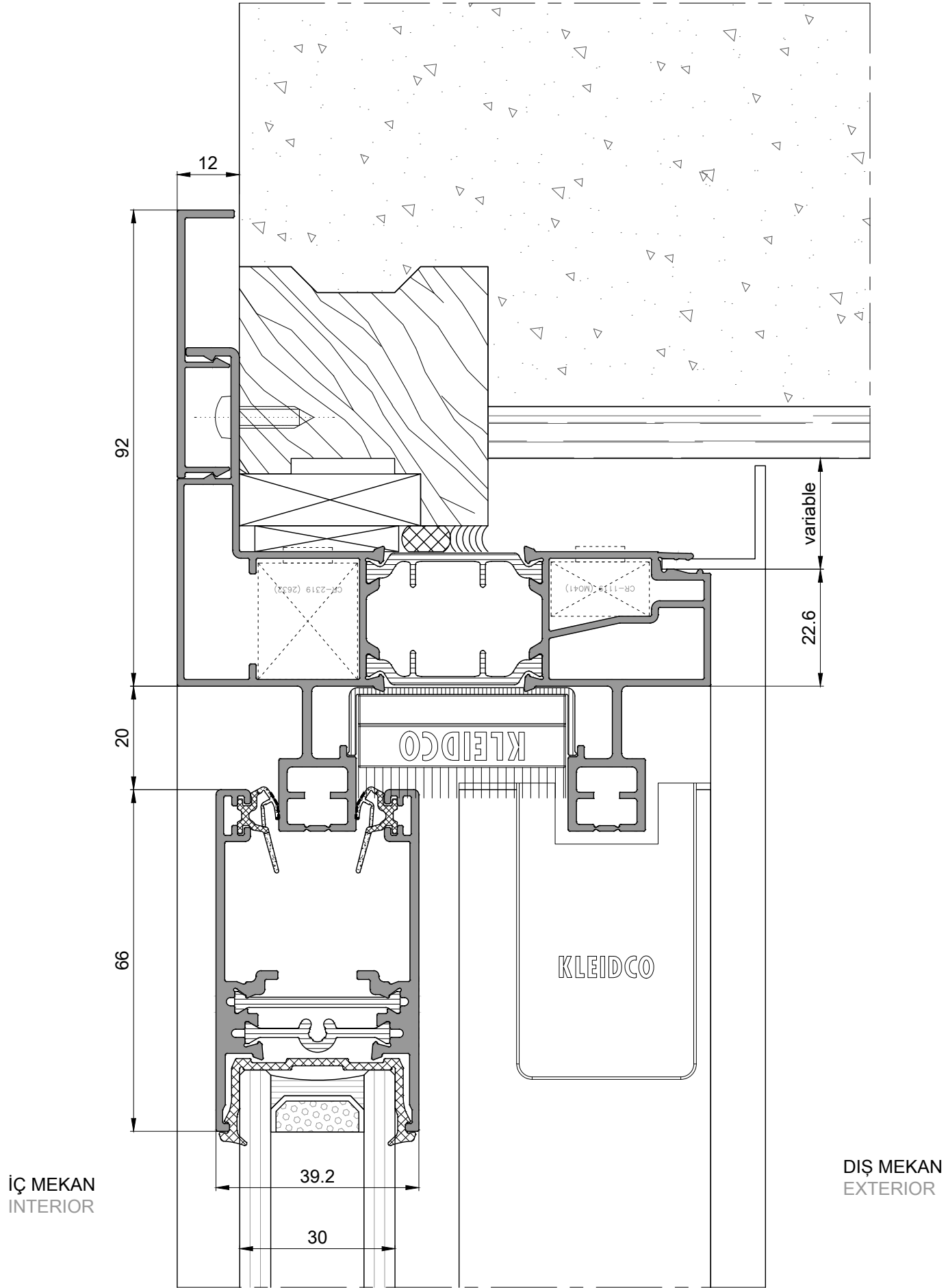
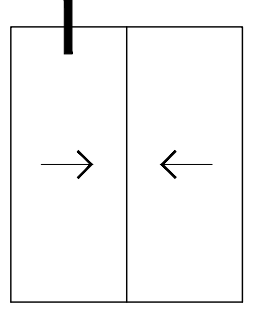

YENİLEME ÜST DETAY
Renovation top detail

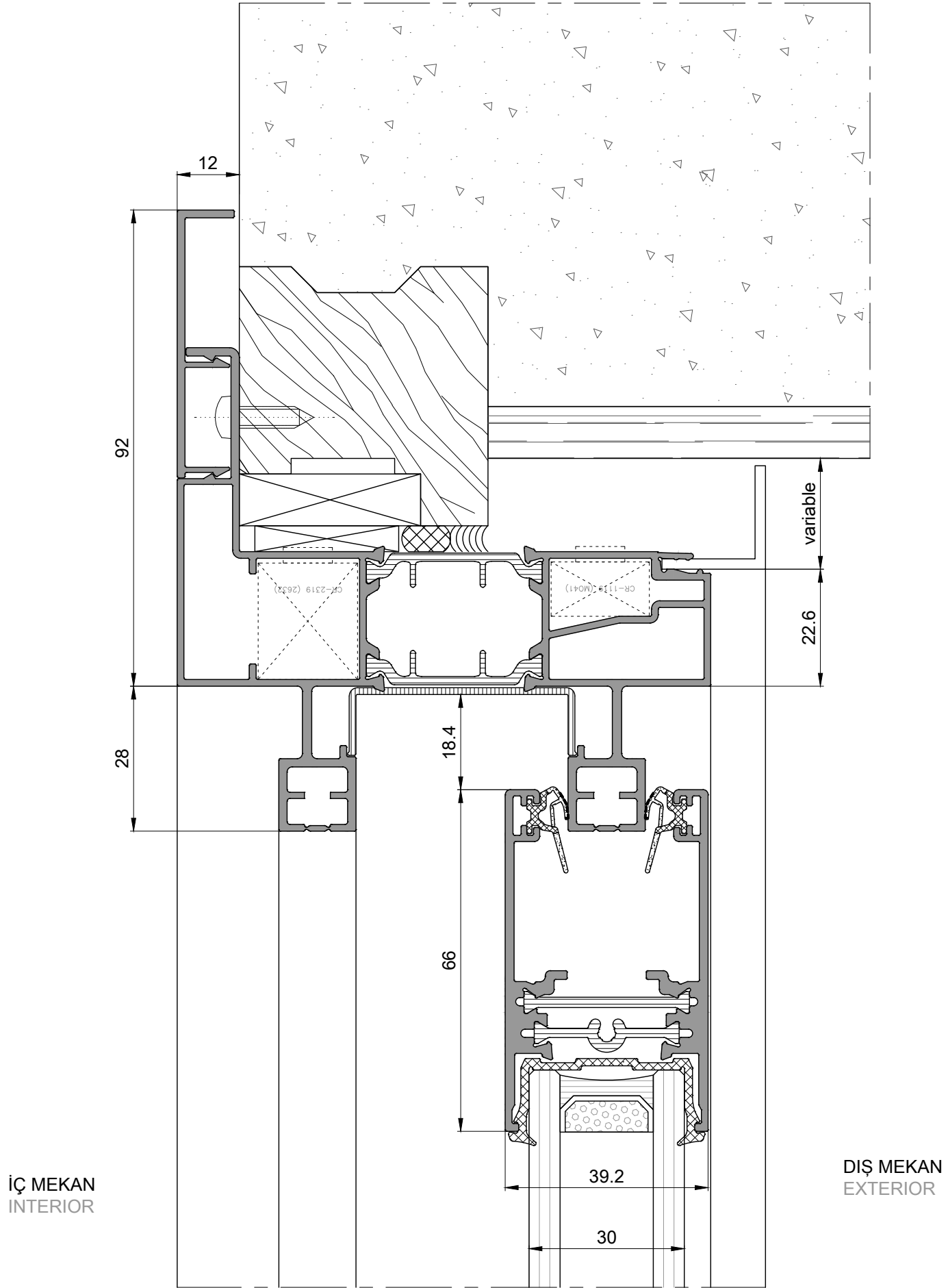
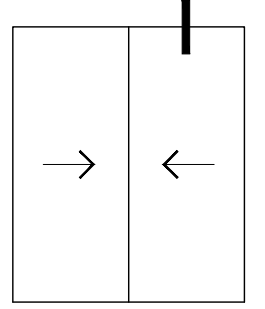

YENİLEME ALT DETAY
Renovation bottom detail

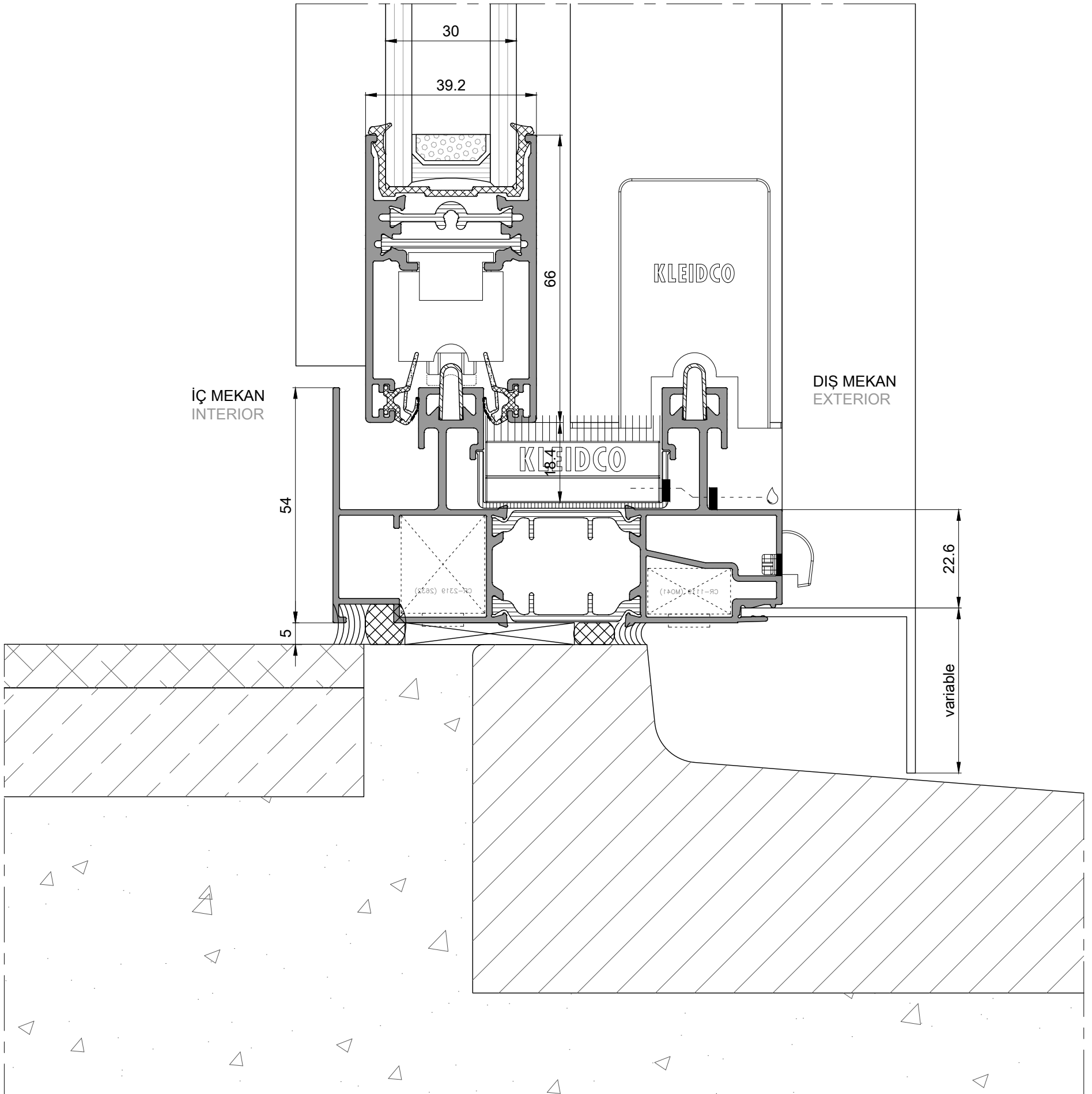
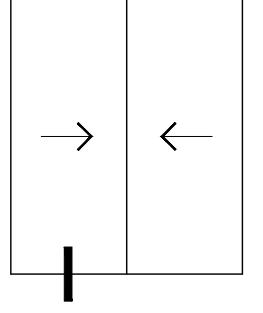

YENİLEME ALT DETAY
Renovation bottom detail

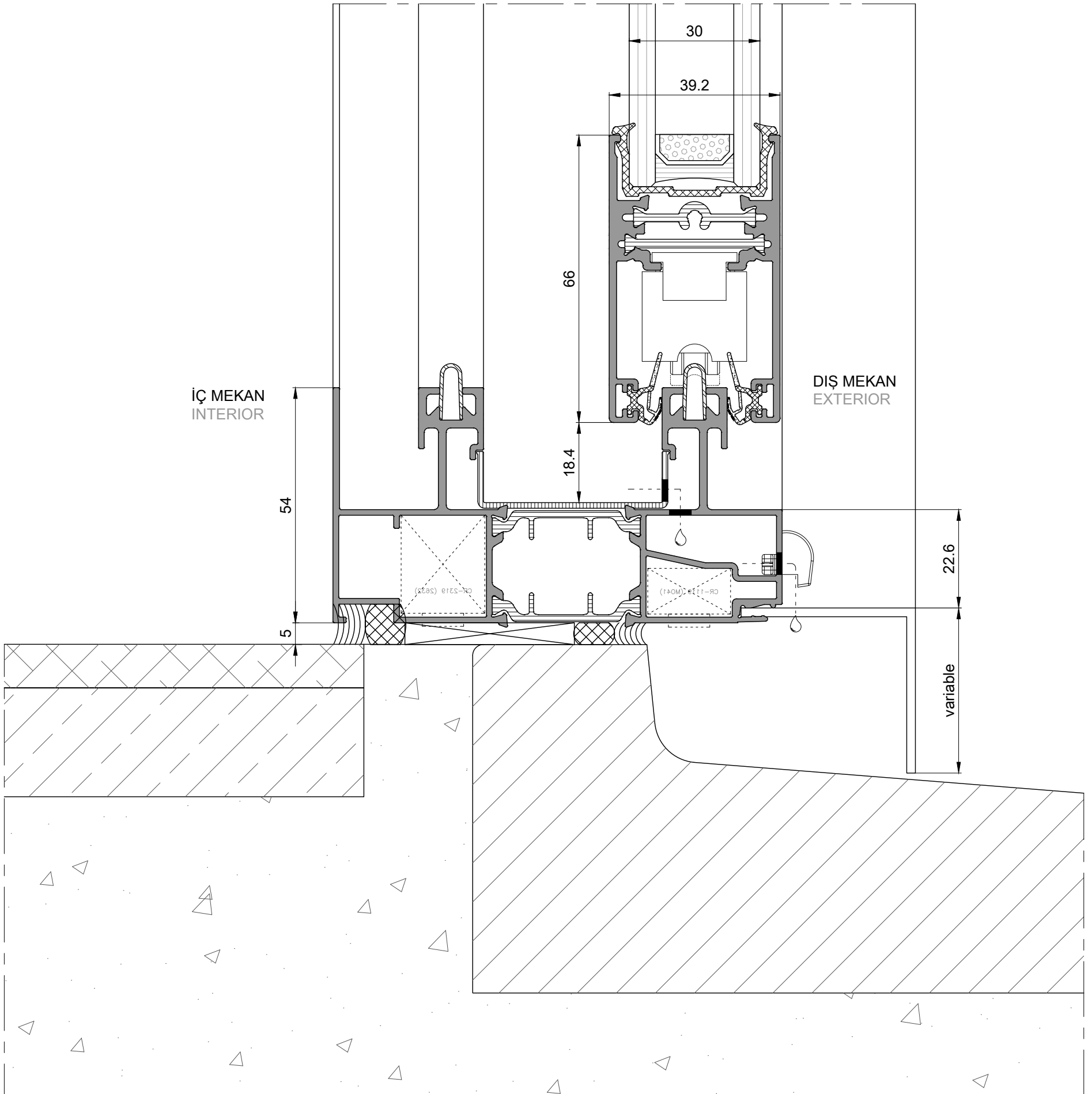
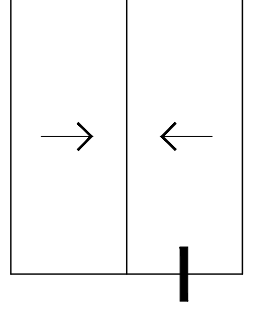

YENİLEME ALT DETAY
Renovation bottom detail

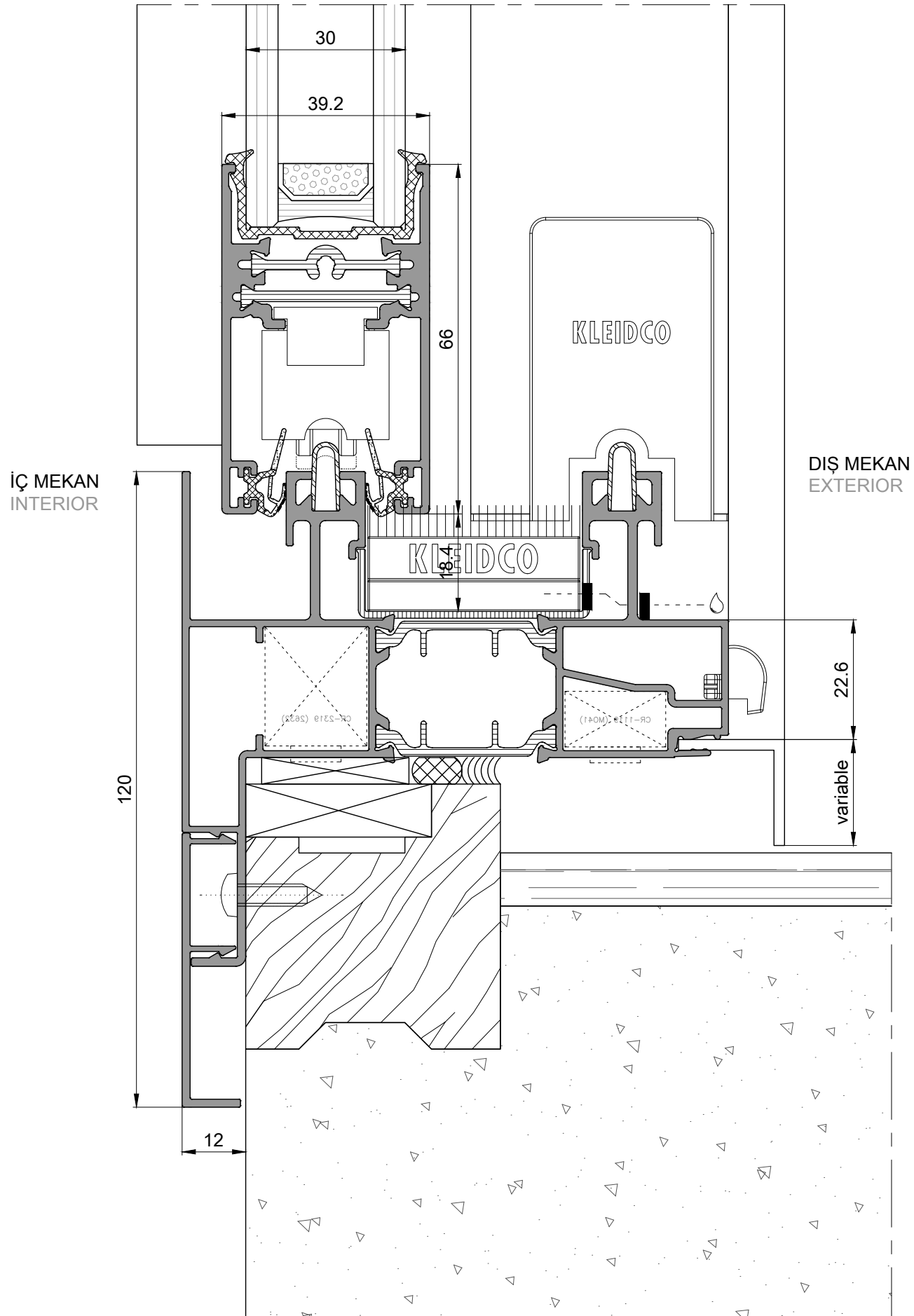
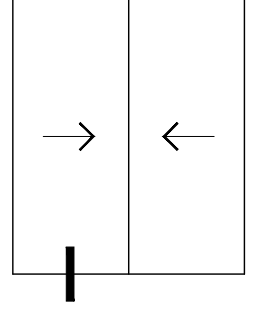

YENİLEME ALT DETAY
Renovation bottom detail

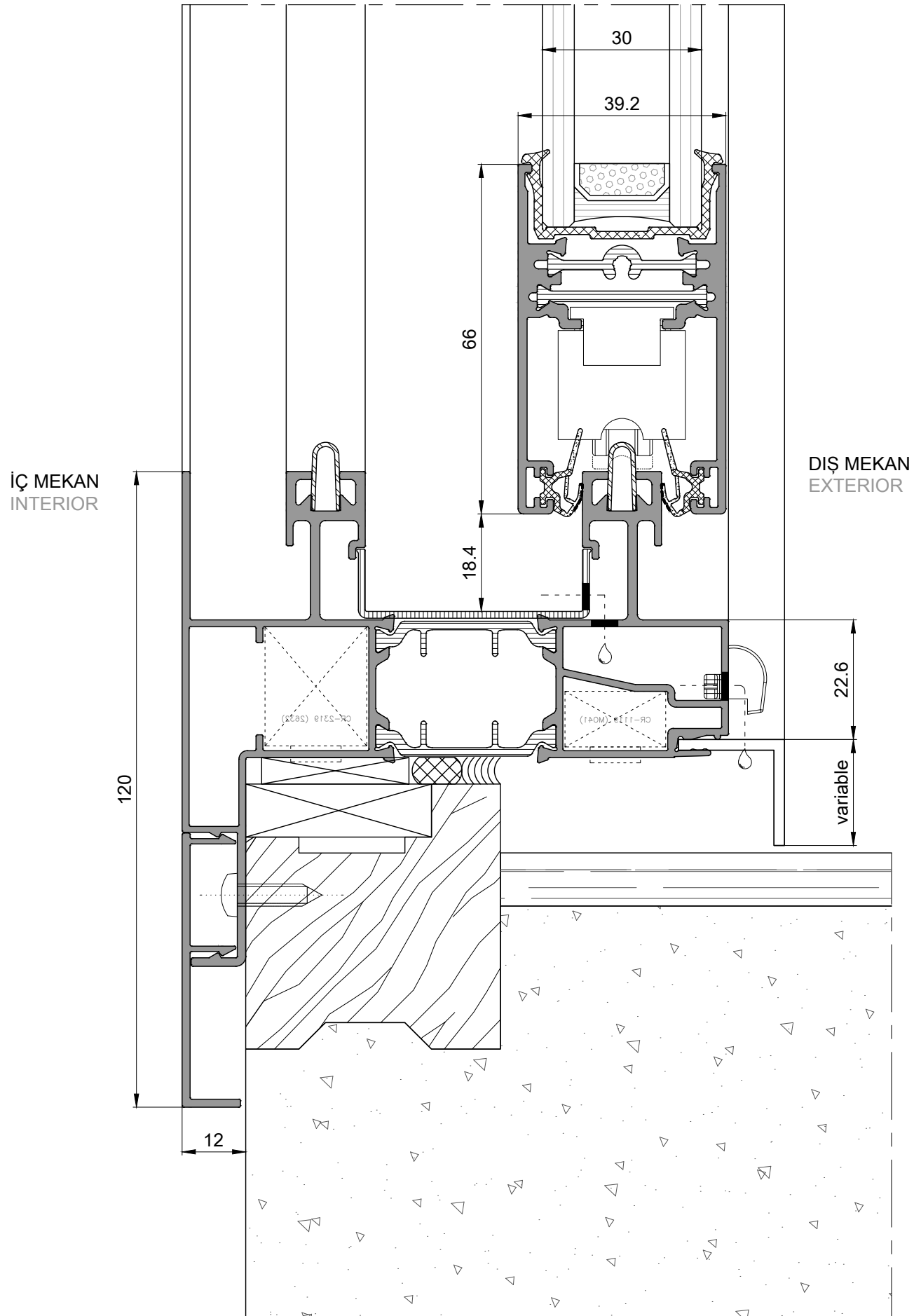
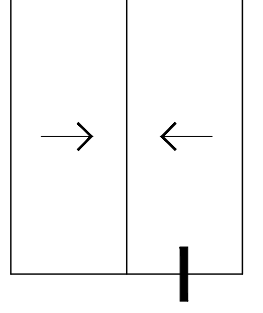

PANJURLU YENİLEME YAN DETAY
Renovation with roller left side detail

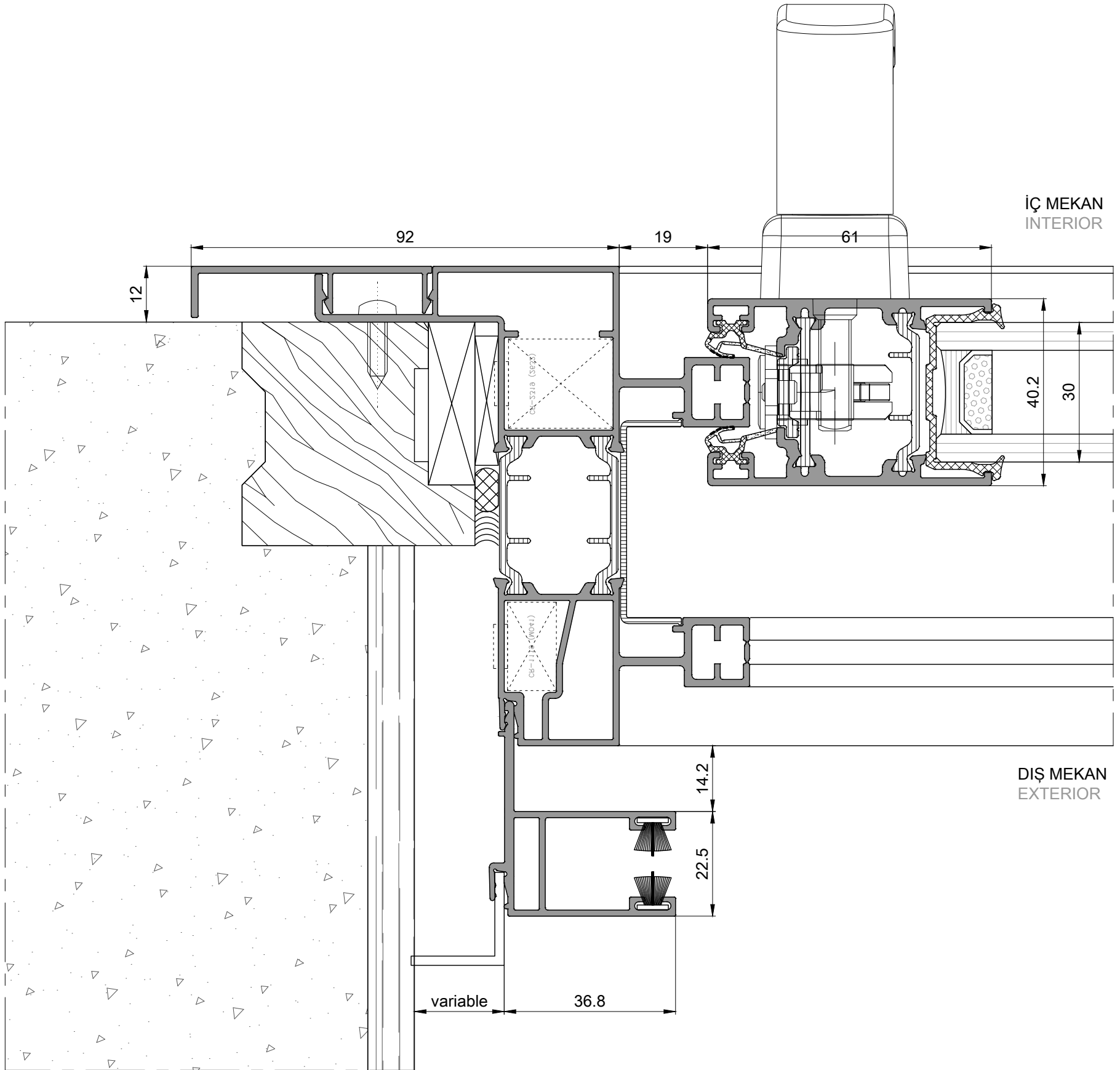
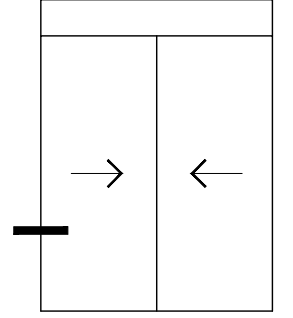

PANJURLU YENİLEME KENET DETAY
Renovation with roller interlock detail

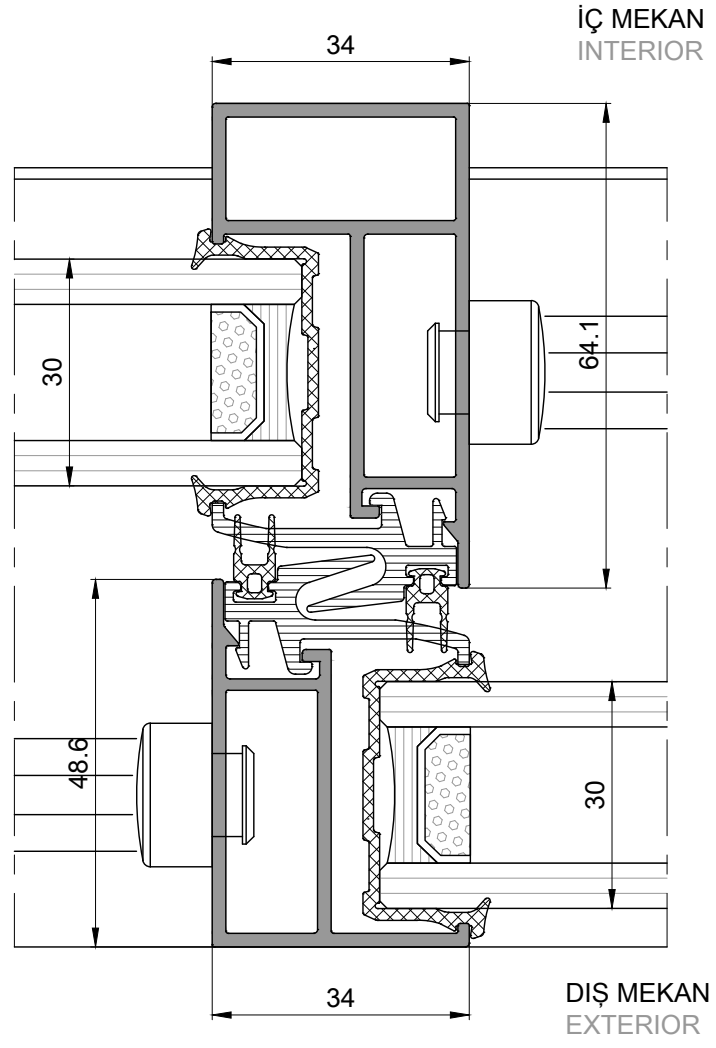
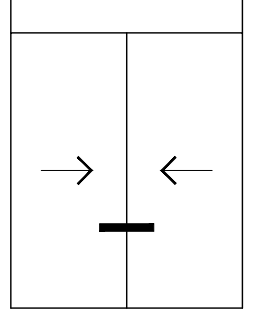

PANJURLU YENİLEME ÇİFT KANAT DETAY
Renovation with roller double sash detail

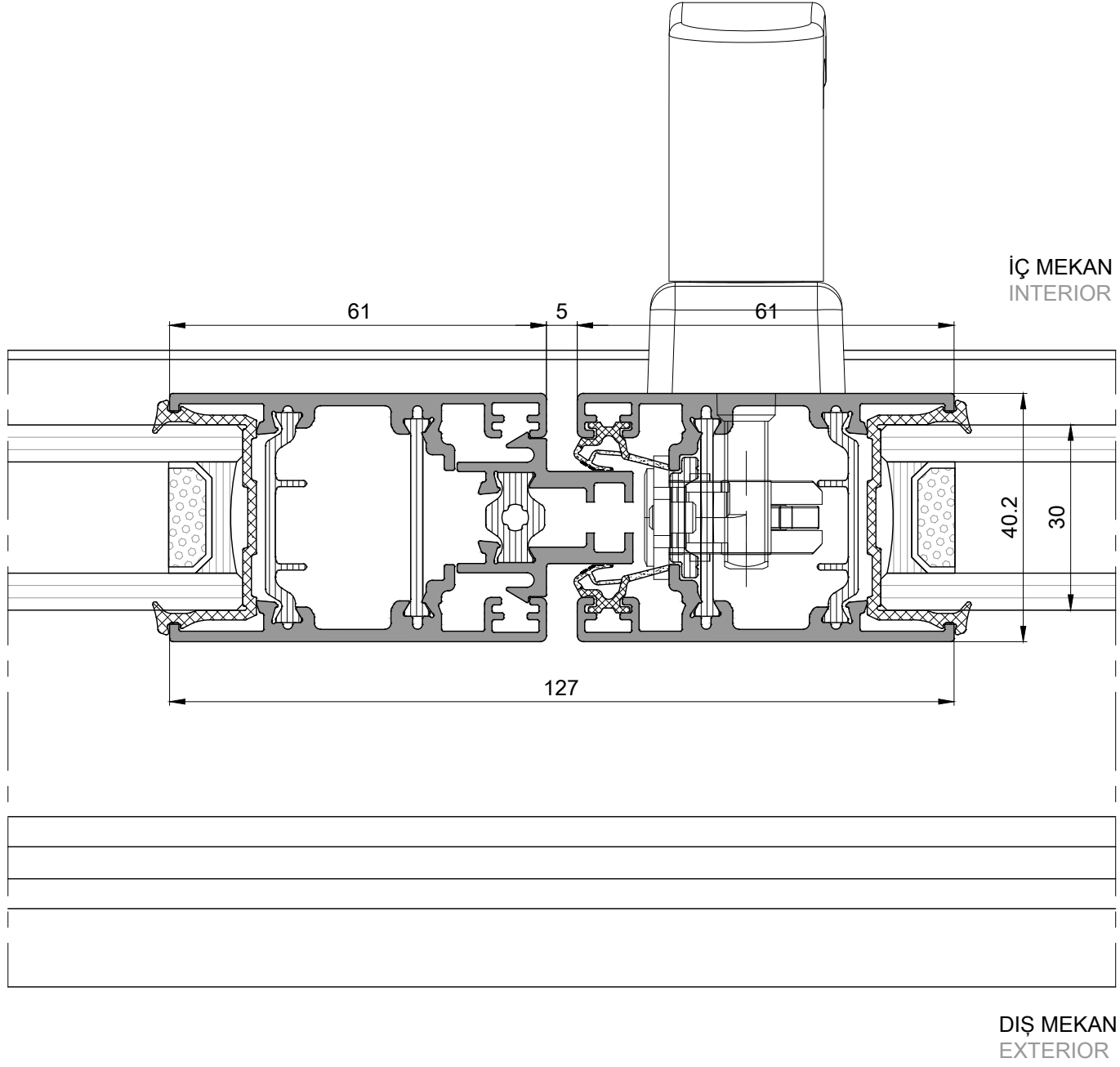
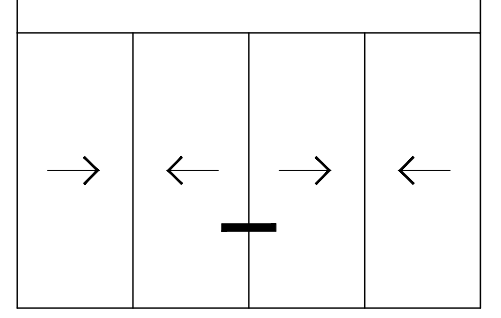

PANJURLU YENİLEME YAN DETAY
Renovation with roller left side detail

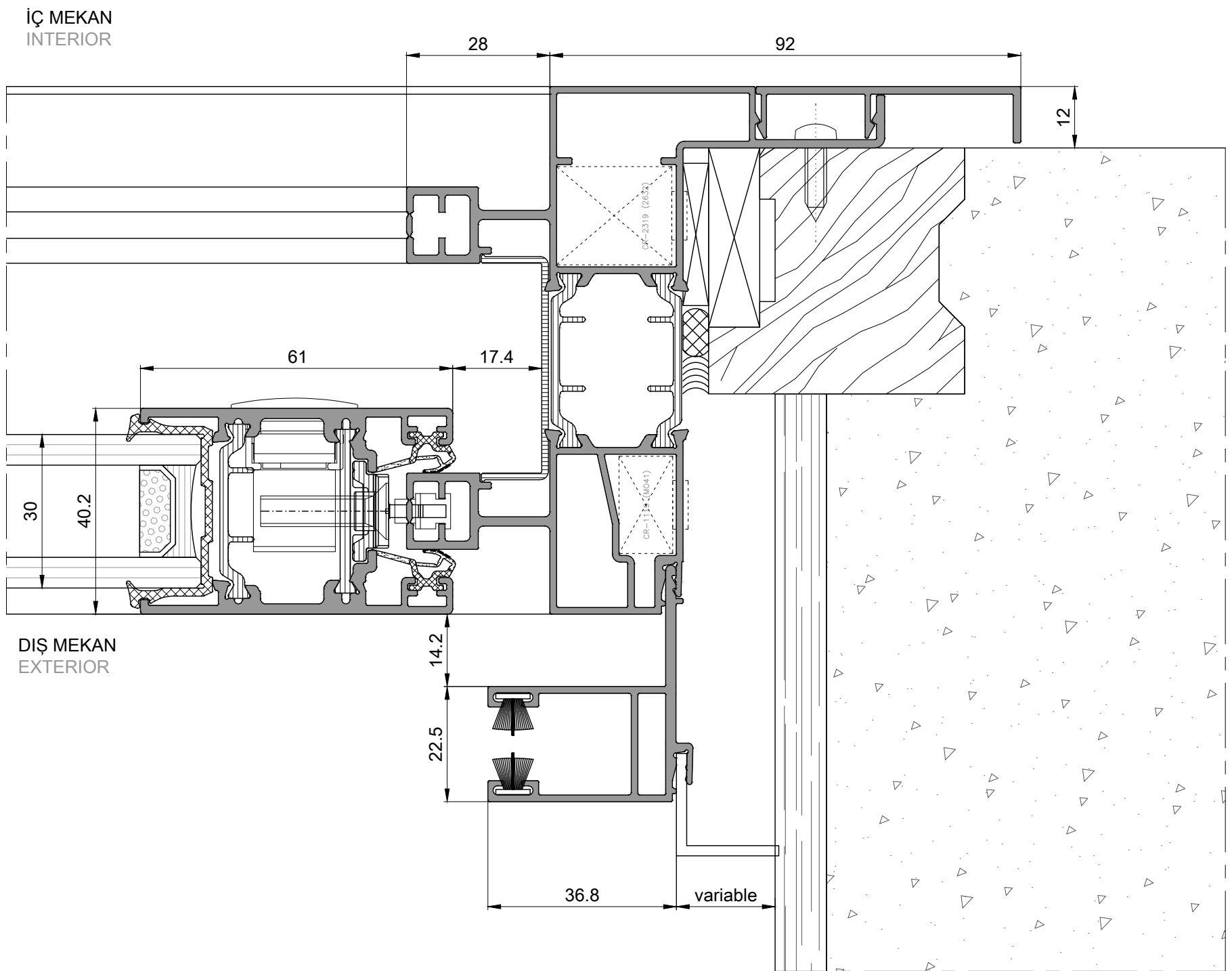
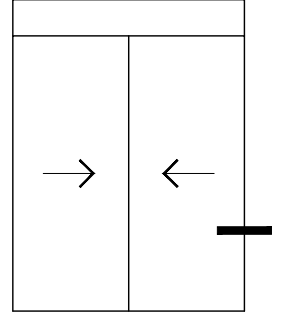

PANJURLU YENİLEME ÜST DETAY
Renovation with roller top detail

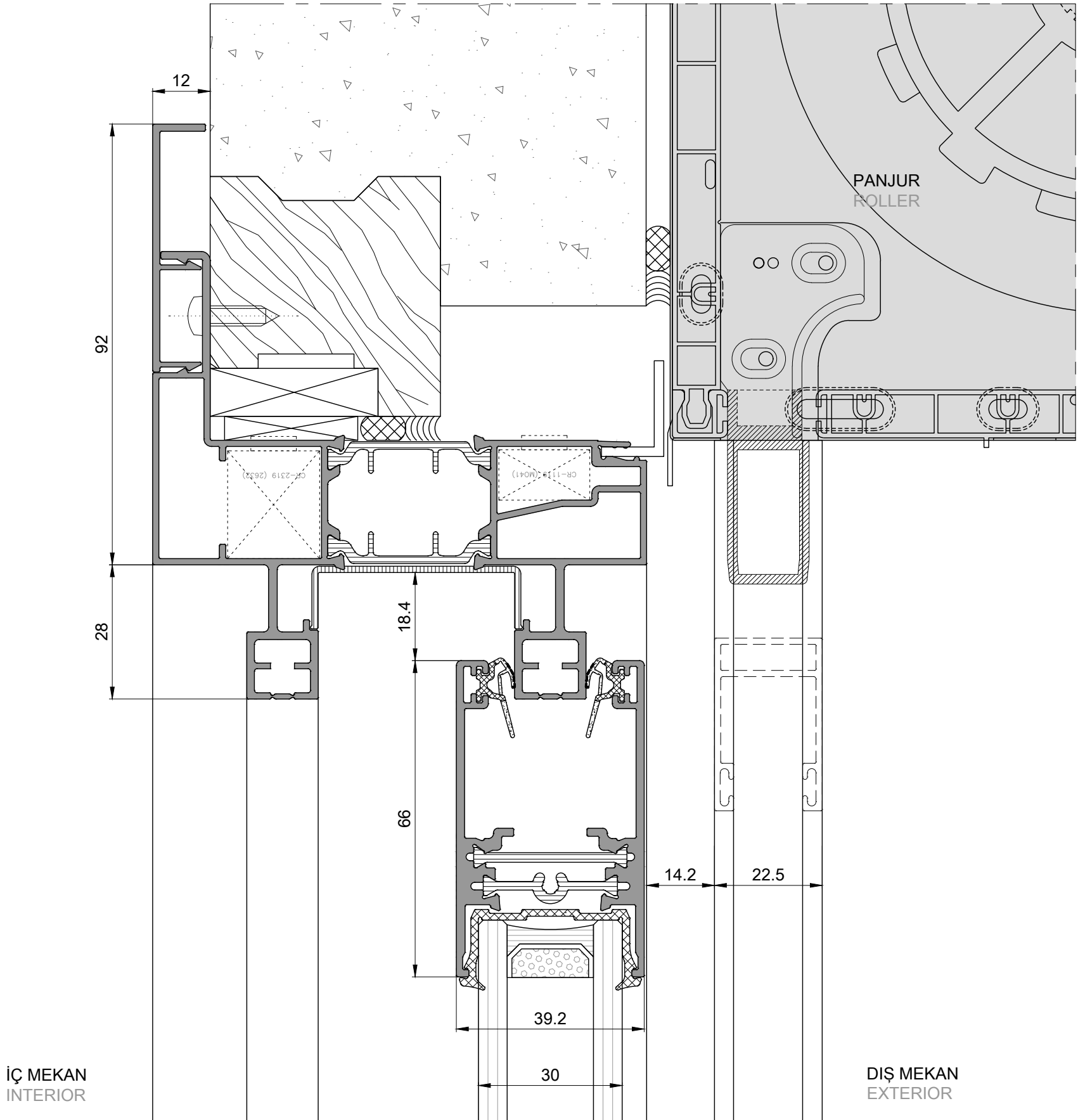
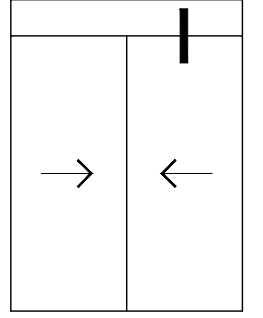

PANJURLU YENİLEME ALT DETAY
Renovation with roller bottom detail

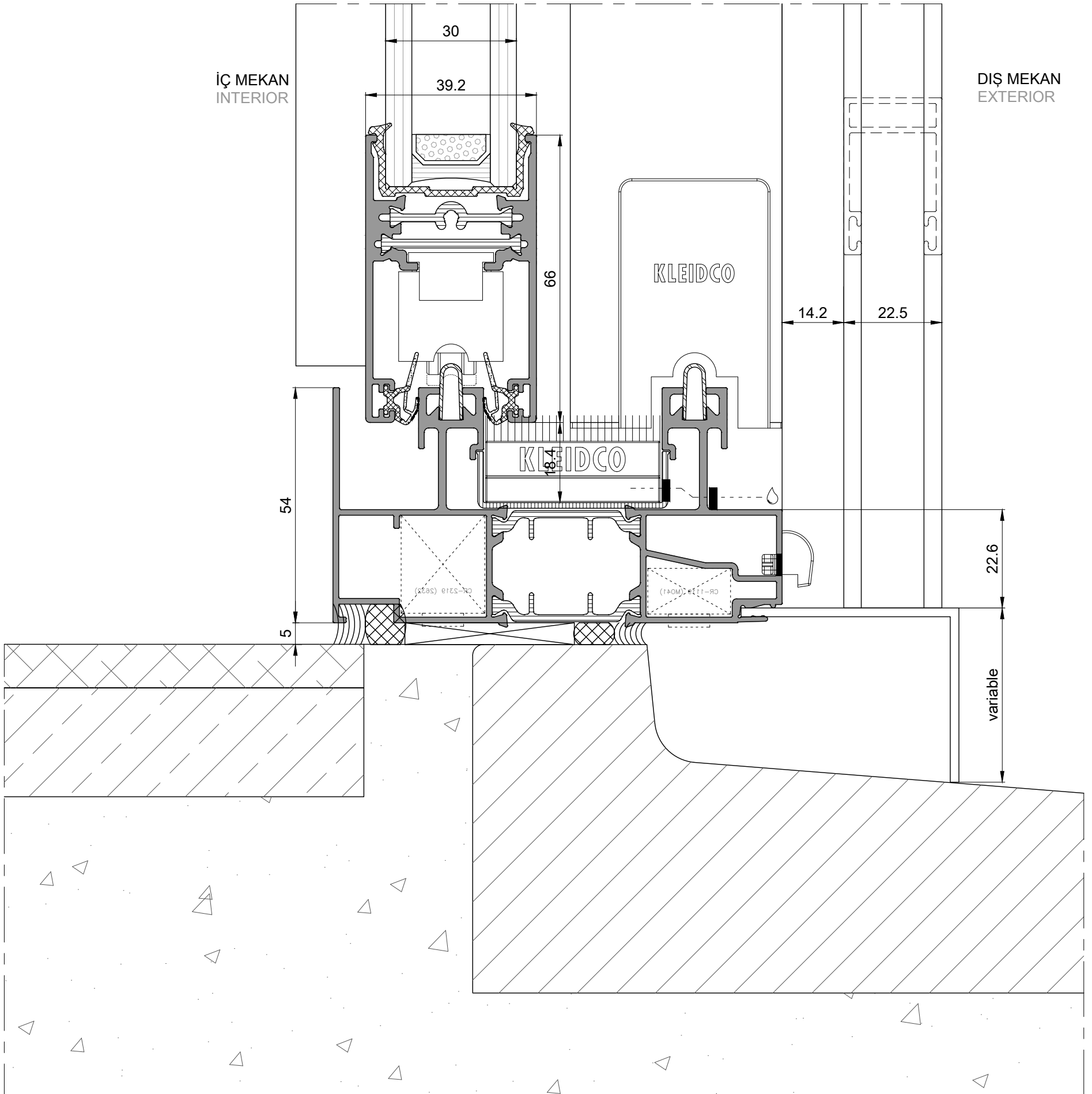
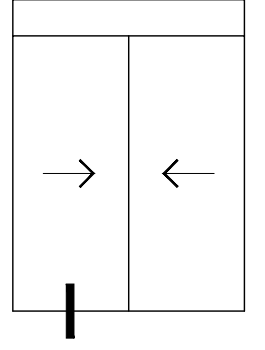

PANJURLU YENİLEME ALT DETAY
Renovation with roller bottom detail

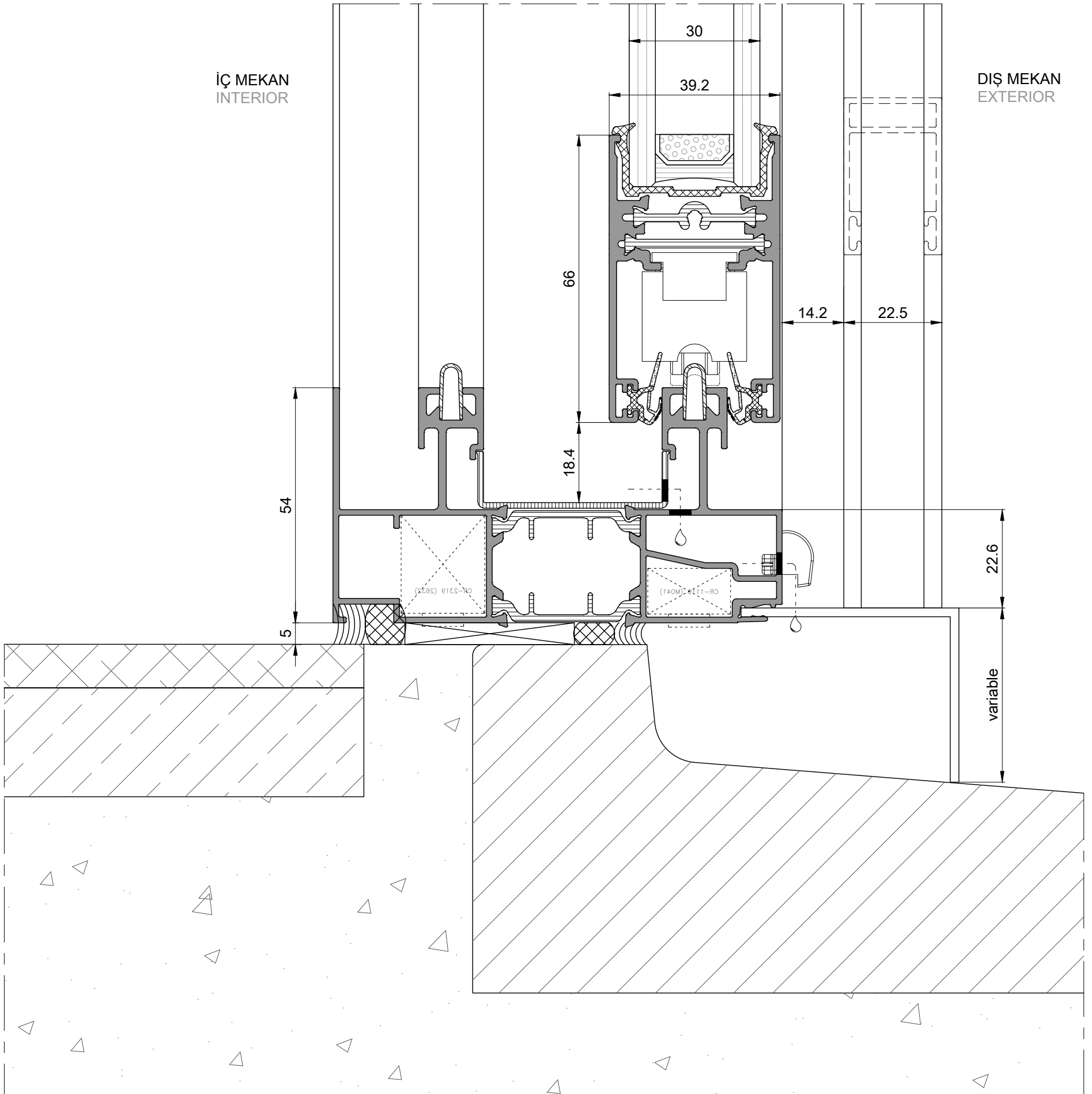
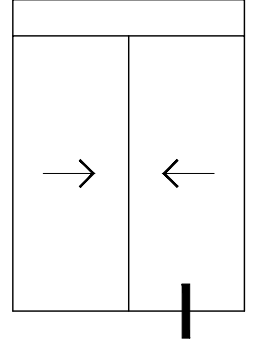

MOTIONslide
SÜRME KAPI ve PENCERE SİSTEMİ
SLIDING WINDOW and DOOR SYSTEM

ÇİFT RAYLI KASA ile DUVAR İÇİNE MONTAJ
PRENSİP SİSTEM DETAYLARI
PRINCIPAL SECTIONS for
POSE CLASSIQUE EN TUNNEL

KLASİK MONTAJLI KASA YAN DETAY
pose classique en tunnel side detail

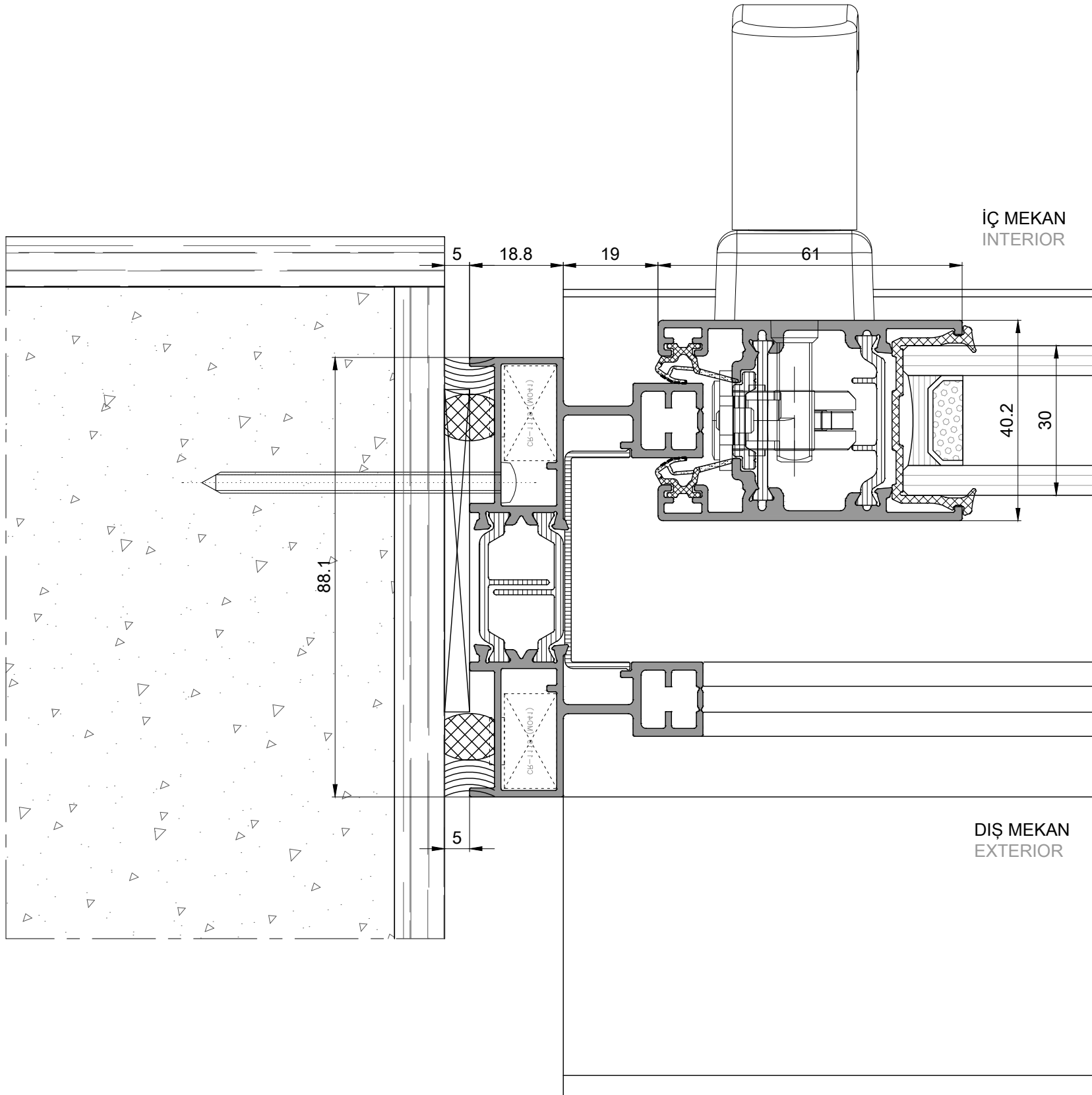
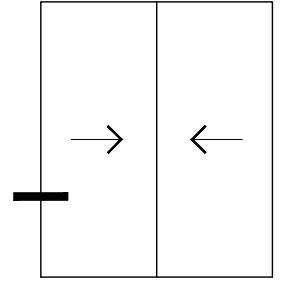

KLASİK MONTAJLI KASA KENET DETAY
pose classique en tunnel interlock detail

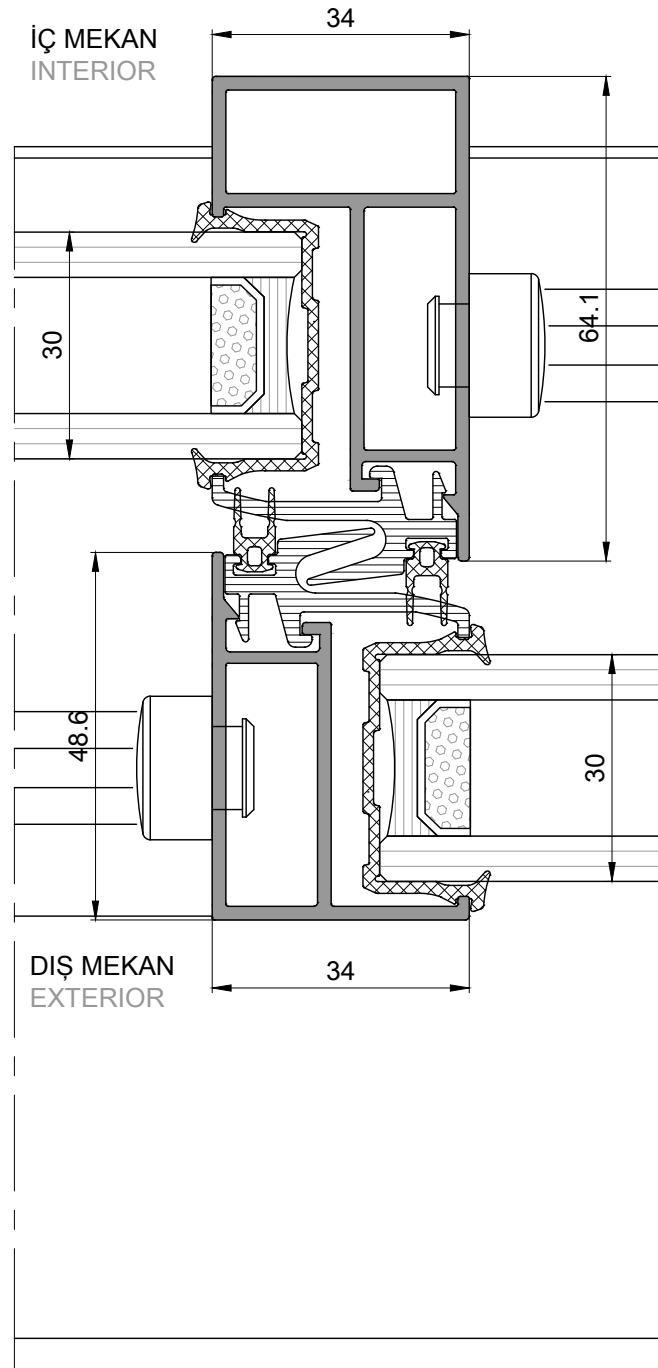
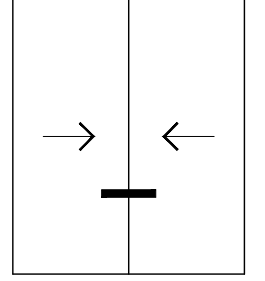

KLASİK MONTAJLI KASA ÇİFT KANAT DETAY
pose classique en tunnel double sash detail

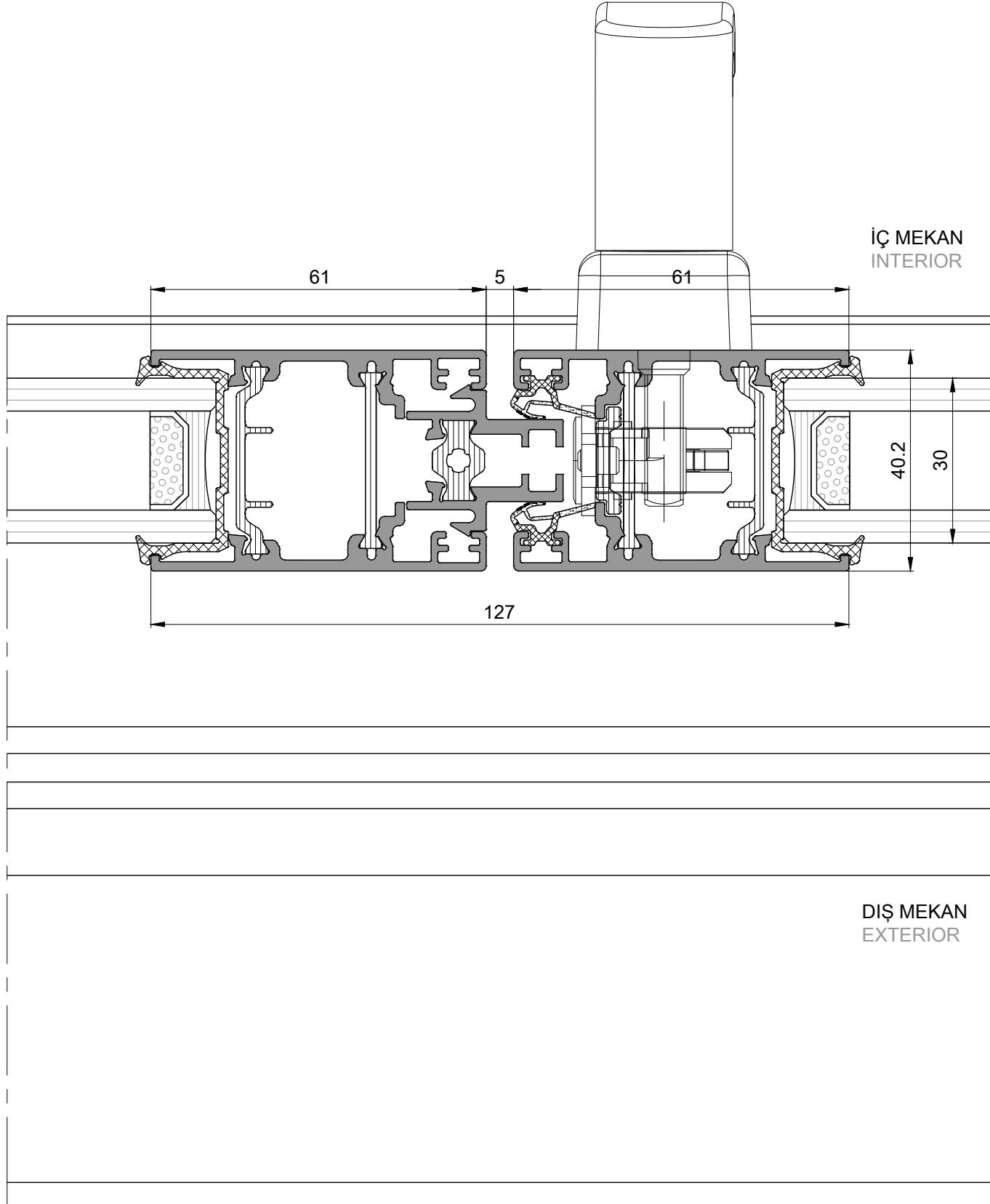
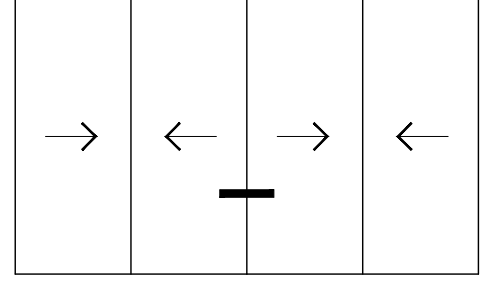

KLASİK MONTAJLI KASA YAN DETAY
pose classique en tunnel side detail

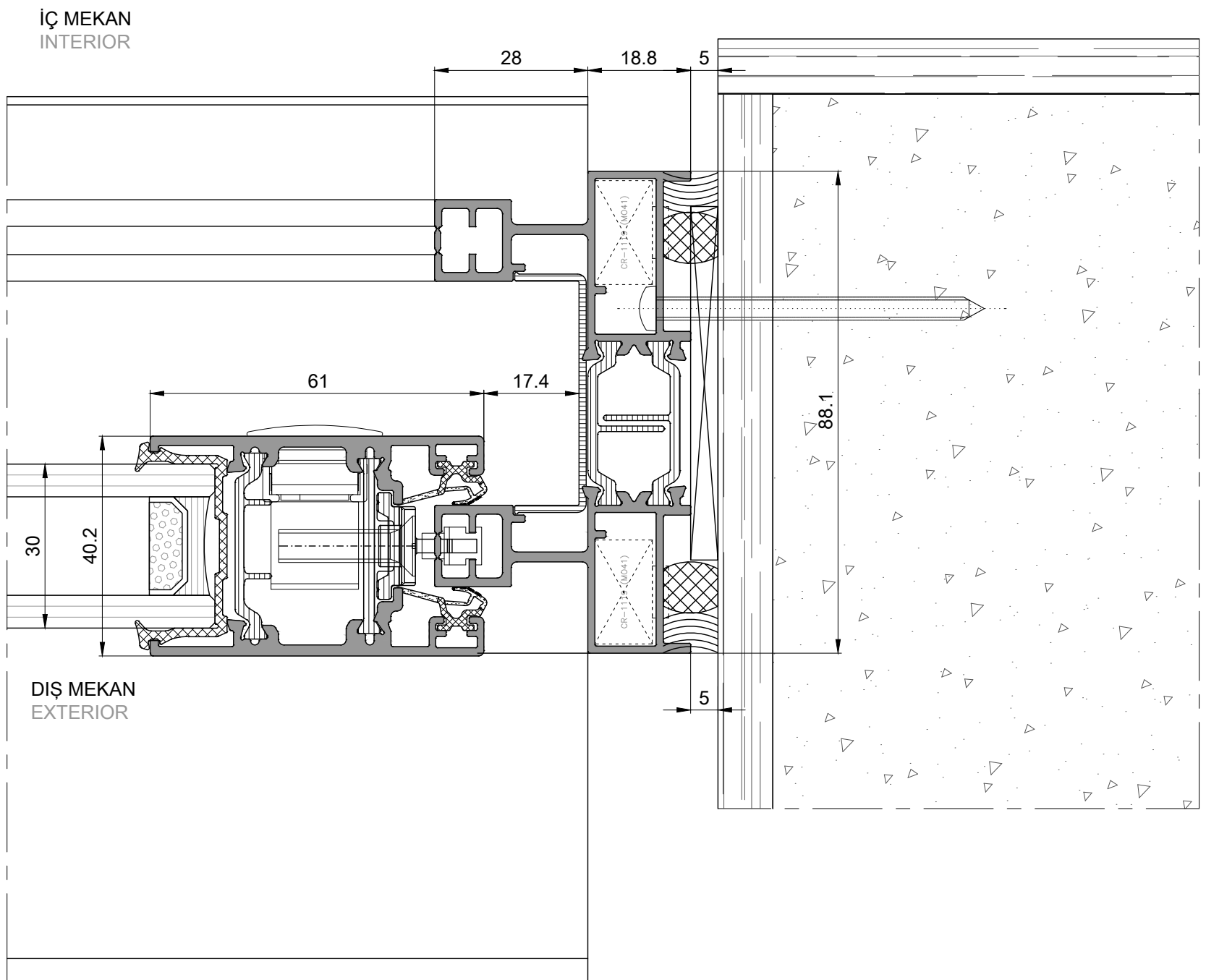
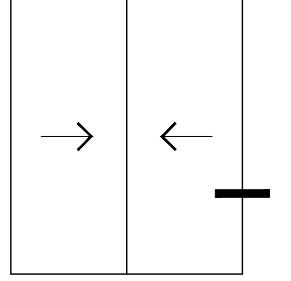

KLASİK MONTAJLI KASA ALT DETAY
pose classique en tunnel bottom detail

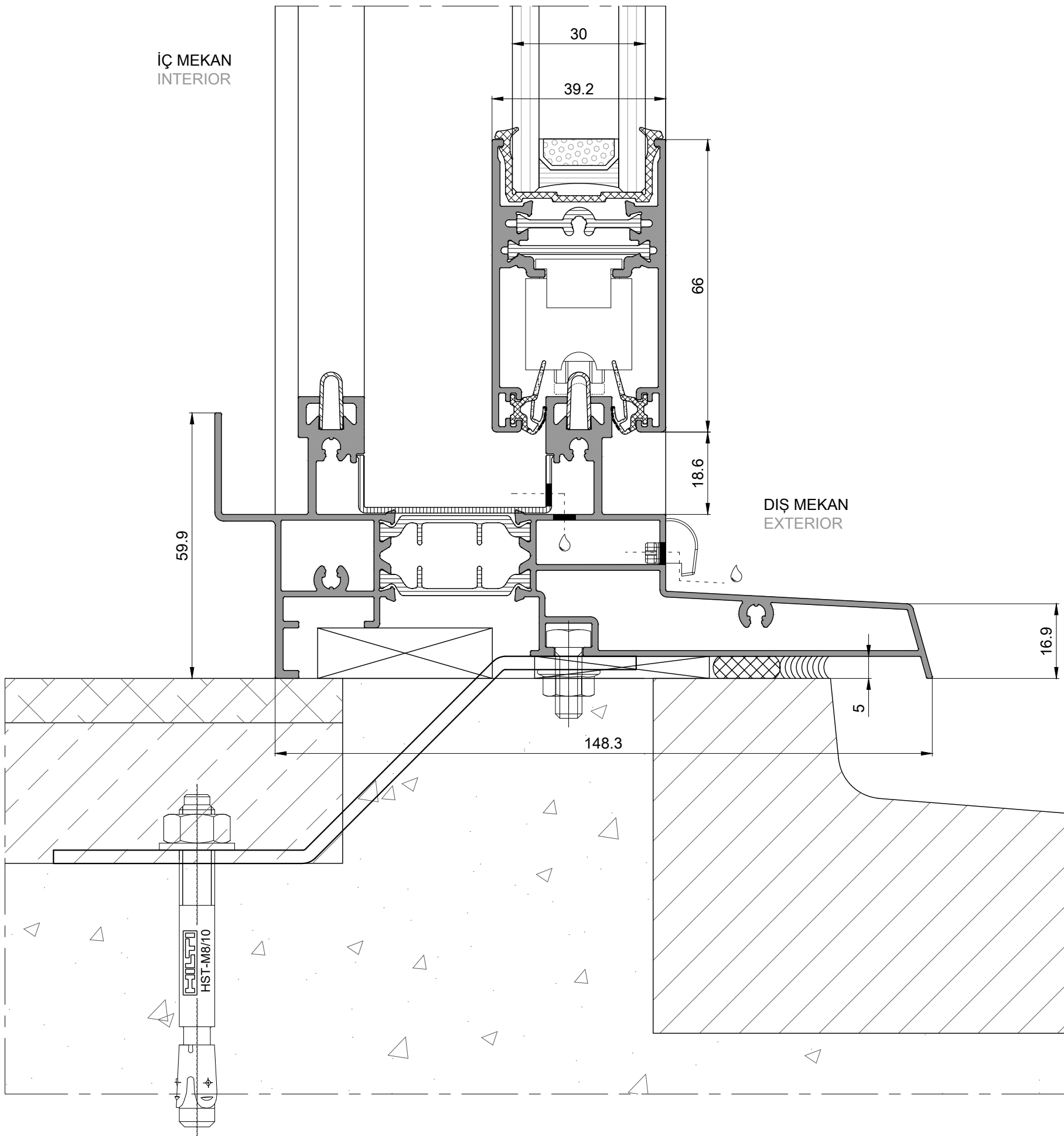
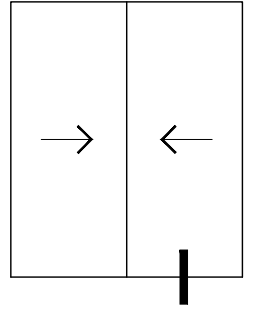

KLASİK MONTAJLI KASA ALT DETAY
pose classique en tunnel bottom detail

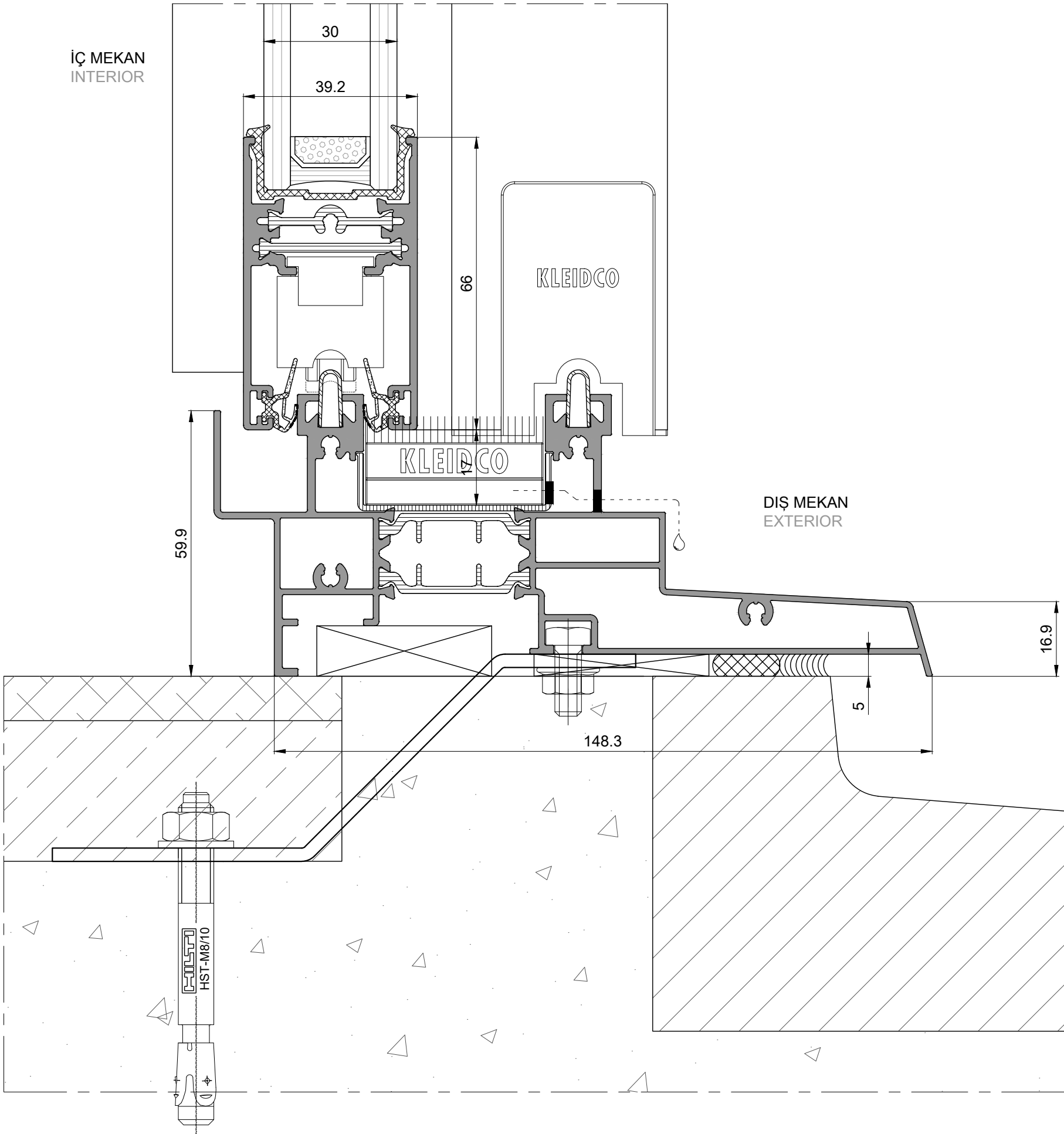
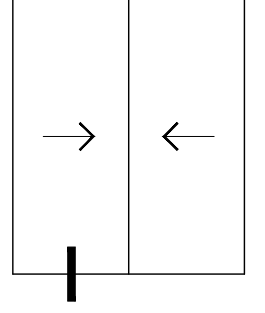

KLASİK MONTAJLI KASA ÜST DETAY
pose classique en tunnel top detail

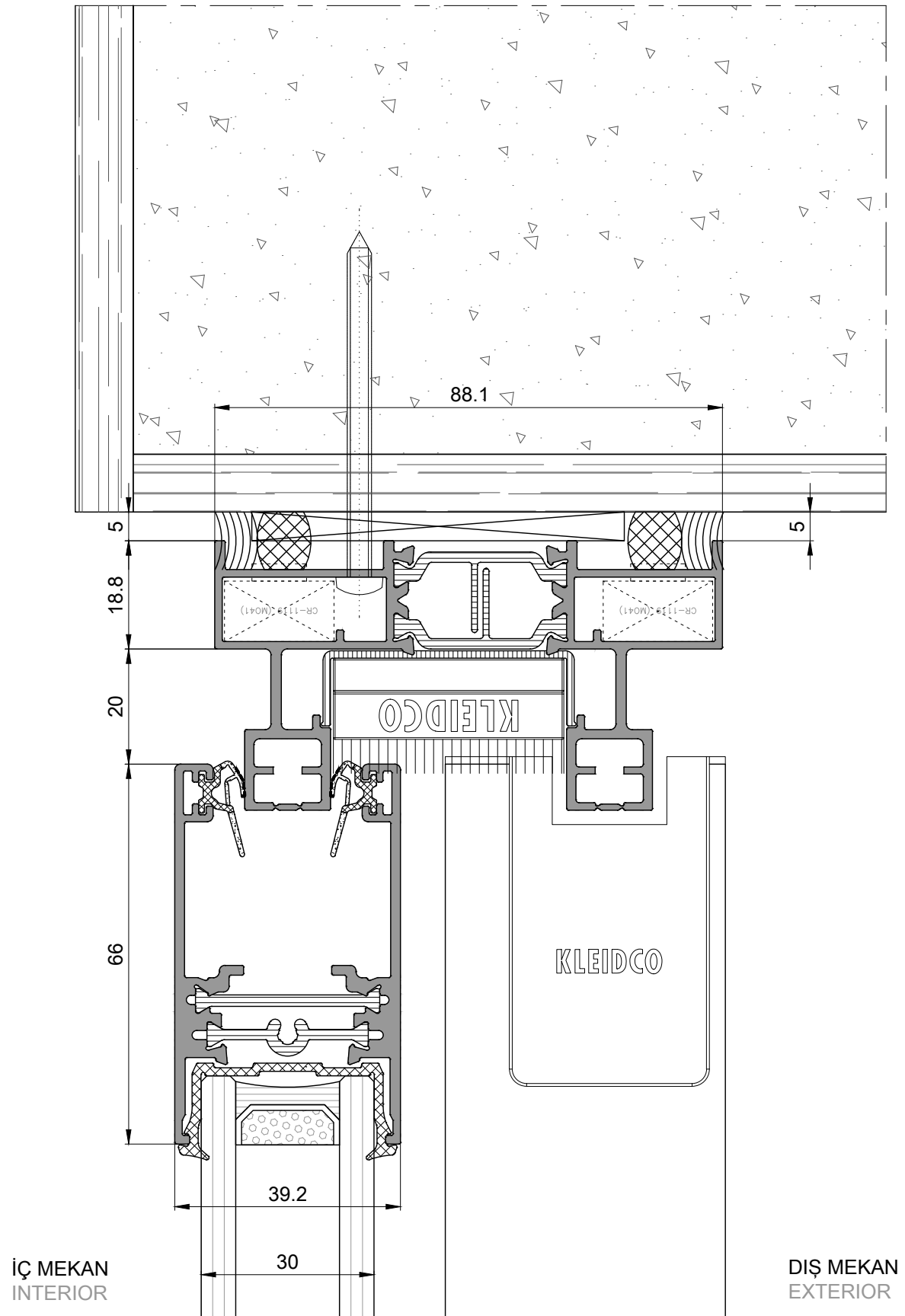
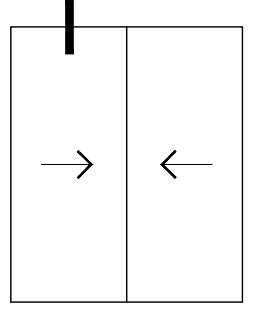

KLASİK MONTAJLI KASA ÜST DETAY
pose classique en tunnel top detail

