

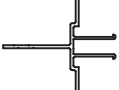





















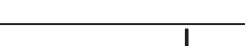

NOT

PROFİL RESMİ PROFILE PICTURE	PROFİL NO PROFILE NO	PROFİLİN İSMİ PROFILE NAME	AĞIRLIK WEIGHT (kg/m)	Jxx (cm ⁴)	Jyy (cm ⁴)
	7601	Taşıyıcı Profili Mullion Profile	0,870	8,92	4,97
	7857	Taşıyıcı Profili Mullion Profile	0,730	-----	-----
	7635	Açılı Dönüş Profili Corner Profile	0,535	-----	-----
	7636	Açılı Dönüş Profili Corner Profile	0,505	-----	-----
	7774	Açılı Dönüş Profili Corner Profile	0,650	-----	-----
	7775	Açılı Dönüş Profili Corner Profile	0,635	-----	-----
	1306	L Destek Taşıyıcı Profili L Mullion Profile	0,480	7,27	0,77
	8269	Ayarlı Üst Bitiş Profili Finishing Profile	0,750	-----	-----
	8270	Ayarlı Üst Bitiş Profili Finishing Profile	0,965	-----	-----
	7645	Alt Bitiş Profili Finishing Profile	0,450	-----	-----
	*12192	Alt Bitiş Profili Finishing Profile	0,430	-----	-----
	*12193	90° Alt Bitiş Profili 90° Finishing Profile	0,545	-----	-----
	*11064	140 mm Cotta Profili 140 mm Cotta Profile	1,195	-----	-----
	7600	150 mm Cotta Profili 150 mm Cotta Profile	1,180	-----	-----
	7632	200 mm Cotta Profili 200 mm Cotta Profile	1,420	-----	-----
	7633	225 mm Cotta Profili 225 mm Cotta Profile	1,545	-----	-----
	7631	250 mm Cotta Profili 250 mm Cotta Profile	1,670	-----	-----
	7634	250 mm Fugalı Cotta Profili 250 mm Cotta Profile with Fuge	1,965	-----	-----
	*11856	Dönüş Profili 90° Corner Profile 90°	1,110	-----	-----
	*11857	Dönüş Profili 90° Corner Profile 90°	1,235	-----	-----
	4747	L Braket 54x80 mm L Bracket 54x80 mm	1,075	-----	-----
	4748	L Braket 54x120 mm L Bracket 54x120 mm	1,400	-----	-----
	4749	L Braket 54x160 mm L Bracket 54x160 mm	1,725	-----	-----

Uyarı: Profil ağırlıklarımız teorik olup; teslim anındaki tartımız geçerlidir.
Warning: the weights of profile is theoretical, weighting at the time of delivery are valid.

* İşaretili kalıp minimum 300 kg üretilir.
* Minimum order quantity: 300 kg

SİSTEM FİTİLLERİ VE AKSESUARLARI

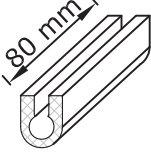
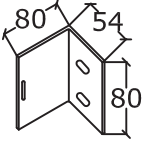
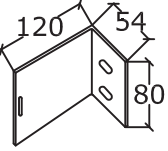
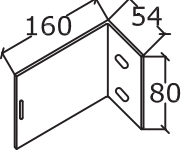
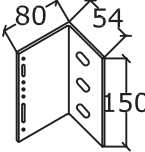
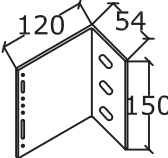
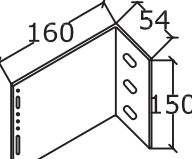
RESİM PICTURE	PARÇA NO PIECE NO	MALZEME MATERIAL	AÇIKLAMA DESCRIPTION	PAKET PACKET
	Epil 200	EPDM	U Fitil (300 m ara ile kullanılır.) U Gasket	250 m/Koli
	SC-526-80	Alüminyum	L Ara Braket 80/80 L Bracket 80/80	İstenilen Miktarda (AD)
	SC-527-80	Alüminyum	L Ara Braket 120/80 L Bracket 120/80	İstenilen Miktarda (AD)
	SC-528-80	Alüminyum	L Ara Braket 160/80 L Bracket 160/80	İstenilen Miktarda (AD)
	SC-526-150	Alüminyum	L Ana Braket 80/150 L Bracket 80/150	İstenilen Miktarda (AD)
	SC-527-150	Alüminyum	L Ana Braket 120/150 L Bracket 120/150	İstenilen Miktarda (AD)
	SC-528-150	Alüminyum	L Ana Braket 160/150 L Bracket 160/150	İstenilen Miktarda (AD)

Teknik Bilgiler/Technical Specifications:

- Sistem soğuk cephe (cold facade) sistemine göre çalıştığından atmosfer etkilerine kısmi olarak açıktır. Dolayısı ile kullanılan tüm elemanlar paslanmaz olmalıdır.

Because the system is designed with in the principles of cold facade, it is open to the atmospheric effects. The refore all the component sand accesories must be steinless steel.

- Braket veya galvanizli ankrajlar sabitlendikten sonra bina yüksek folyolu dansiteli taş yünü veya foambord ile kaplanır. Isı yalıtım malzemelerinin kalınlığı yapıda istenilen ısı geçiş katsayısına göre belirlenir.

After positioning of bracket sorgalvinised anchorages ,the building is covered by choosen isolation material (rock woolor styrofoam).The thickness of the isolation material is related with the needed isolation standarts of the building.

- Düşey taşıyıcı profillerin ek yeri döşeme hizasında taşıyıcı braket veya galvanizli ankrajlara denk getirilmelidir. Şekil A'da görüldüğü gibi profiller üst noktalarından iki veya braketin uzunluğuna göre daha çok perçinle sabitlenir. Alt noktaları ise bakla deliğinden bağlanarak genişmesi sağlanır.

The connection part of the mullion profiles must be positioned at the floor level and bring qualto the brackets galvanised anchorages.Profiles on the top side should be positioned by two or more (relatedly with the lenght of the profile) rivets.Bottom side of the profiles shold be connected to the canal hole to maintain the dilatation.(Please see the drawing A)

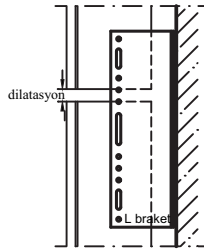

ŞEKİL A

- Yapılmış olan statik hesaplara göre 100 m yüksekliğindeki binalarda $W=132 \text{ kg/m}^2$ C1,20 alınarak, 100 m üstünde ise $W=156 \text{ kg/m}^2$ alınarak yapılan hesaplar iki açıklık ve üç mesnetli olarak kabul edilmiştir.Ankrajların ara mesafesi 100 m yüksekliğindeki binalar için $L=1,50$ m yi 100 m üstü binalar için $L= 1.25$ m yi geçmesi tavsiye edilmez.20 mt üzerindeki binalarda 200' lük 7632 nolu cotta lambri kullanılması uygundur.

According to the static calculations $W:132 \text{ kg / m}^2$ C1,20 for the buildings up to 100 m. height, $W:156 \text{ kg/m}^2$ for the buildings higher than100 m. And calculation have been made considering consistance of two spaces and three supports.The distance between anchorages is not recomended for the buildings up to 100 mt. More than $L: 1,50$ m t and for the buildings heigher than 100 m. $L:1,25$ m. It is suitable tousecotta profile number 7632 (200 mm) with the buildings heigher than 20 m.

- Kullanılacak olan braketler statik hesaba göre belirlenir.

Brackets which will be used are decided according to the static calculation.

Yatay ve düşey derzlerin düzgün devam edebilmesi için braket veya galvanizli ankrajlar çakılmadan ve düşey profiller konmadan önce kottların ölçüm aletleri ile belirlenmesi şarttır.

It is a must to determine the levels with measurement devices before fixation of bracket sor galvanised anchorages and mullion profiles to continuo proper horizontal or verticalres.

- Pencere açıklıkları, harpuşta ve bitişlerde su yalıtımı için yalıtım membranı uygulanır.

For water isolation it is needed to applicate isolation membrane to the window gaps ,end sand coping of the building.

- Alüminyum profiller AL MgSi 0,5 F22 (AA 6063-T5) olmalıdır.

Aluminium profiles should be AlMgSi 0,5 F 22 (AA6063 - T5)

- Profiller istenilen renkte boyanır.

Profiles can be painted to any colour.

Montaj Sırası/Application:

1. Her katın döşeme hizasına, uygun ölçüde ana braketler veya galvanizli çelik ankrajlar dübellenir. İki ana braket arasına ara braket kullanılır. Braket ve ankrajlar yeterli miktar ve M10x85 -110 çelik paslanmaz çelik dübel ile binaya monte edilir. Ana ankrajlar 2 adet M10 dübel ile, ara ankrajlar 1 adet M10 dübel ile monte edilecektir.

Suitable sized main brackets or galvanised steel anchorages are fixed to each floors flooring level. Auxiliary brackets are used between each two main brackets. Bracket sand anchorages are fixed to the building with enough number of steel (M10*85-110) dowels or stainless steel dowels. Main anchorages should be fixed with 2 pcs of M10 dowels and auxiliary anchorages should be fixed with 1 pcs of M10 dowels.

2. Dikme profilleri braketlere 4,8 x15 mm geniş kafa pop perçin ile veya galvanizli ankrajlar M10x25 mm paslanmaz çelik civata somun grubu ile monte edilir.

Vertical profiles is fixed to the brackets with 4,8*15mm wide head pop rivets or galvinised anchorages is fixed with M10-25mm stainless steel bolt and nut group.

3. Dikme profilleri arasına en alttan başlayarak dikme profiline 4,2x20 mm lik matkap uçu vida ile bağlanır. Lambri profilleri maksimum 60 cm' de bir vidalanmalıdır. Bir üstteki lambri profili montaj yuvasına geçirilmeden önce topuzuna epil 200 fitil geçirilir. Epil 200 fitiller cephenin hava alabilmesi ve ses izolasyonu bakımından yaklaşık 8 cm uzunluğunda profilin başından ve sonundan 50 mm açıklığından başlamak sureti ile 30 cm lik aralıklarda parçalar halinde uygulanır.

Cotta profiles is fixed to the mullion profiles using 4,2-20mm drill screws.Cotta profiles should be fixed (screwed) maximum once with every 60 cm. Epil 200 gaskets should be applicated to the knob of the cotta profiles before fixation of then extone.Epil 200 gaskets should be used for cotta profiles approxi mately 8 cm long ,one side to another ,one swit hevery 30 cm,alsobeginningandend of the profile with 50 mm innerside.

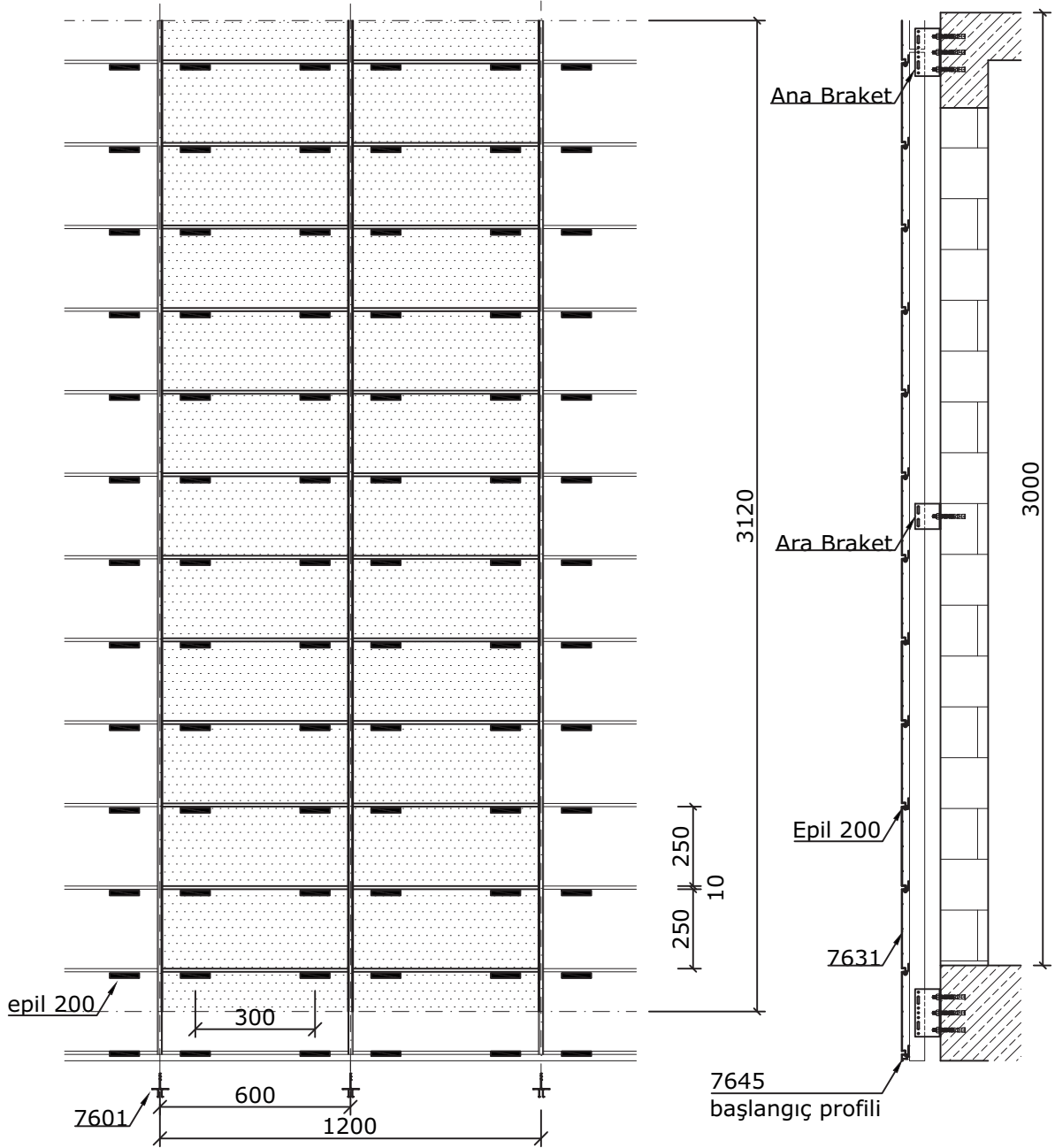

SARAYCOTTA ANALİZ ÖRNEĞİ			
(1,20mx3,12m=3,744 m2 için) (1m2=7,72 kg)			
Malzemenin Cinsi	Birim	Miktar	Toplam
7601 Dikme profili	0,870 kg/m	6,240 m (3,12 m x 2 ad)	5,43 kg
7631 250'lik cotta	1,670 kg/m	14,064 m (0,586 mx24 ad)	23,49 kg
80x150 Ana Braket	3 adet	1 adet	3 adet
80x 80 Ara Braket	3 adet	1 adet	3 adet
Epil 200	2 adet	24 adet	48 adet
4,8x15 mm Geniş Kafa Pop Perçin	3x3=9 ad (Ana braket) 3x1=3 ad (Ara braket)	9 ad+3 ad	12 ad
Çelik Dübel (paslanmaz)	3x2=6 ad (Ana braket) 3x1=3 ad (Ara braket)	9 ad+3 ad	12 ad

Uyarı: Profil ağırlıklarımız teorik olup; teslim anındaki tartımlar geçerlidir.
Warning: the weights of profile is theoretical, weighting at the time of delivery are valid.

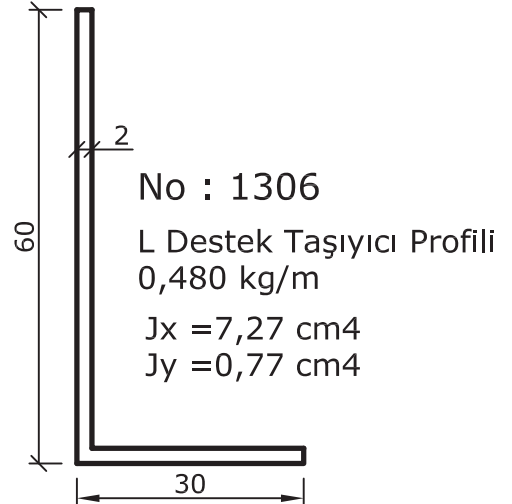
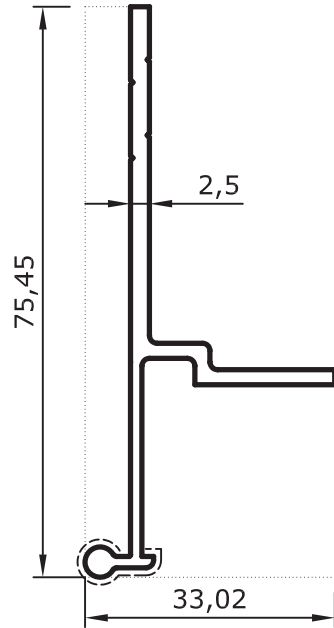
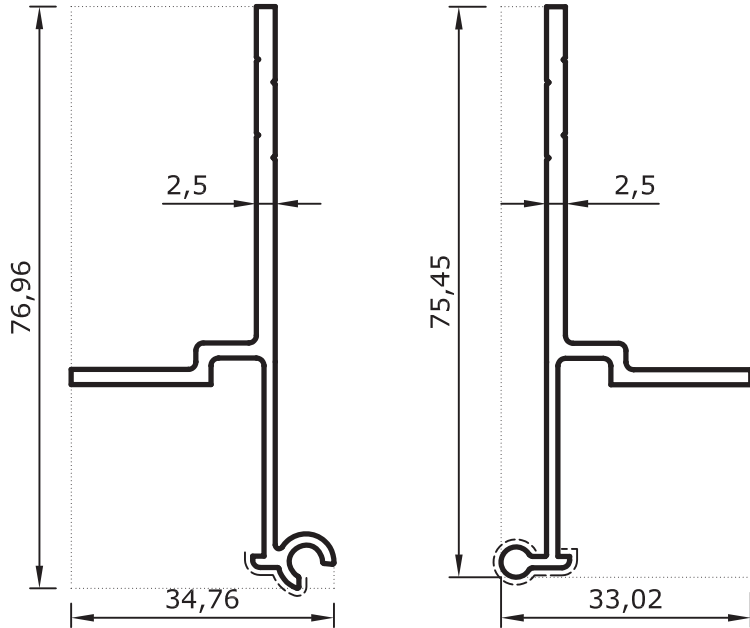
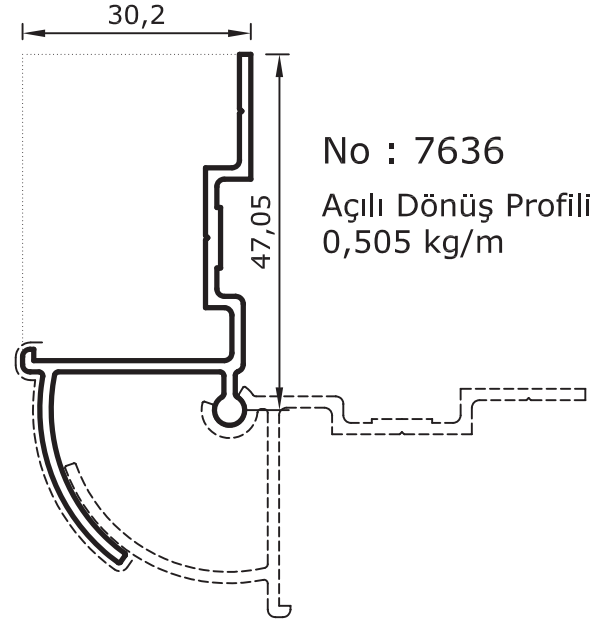
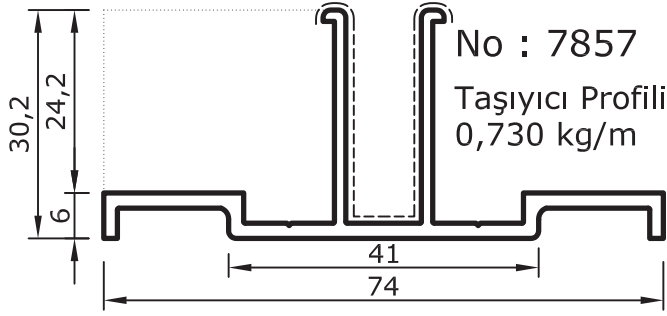
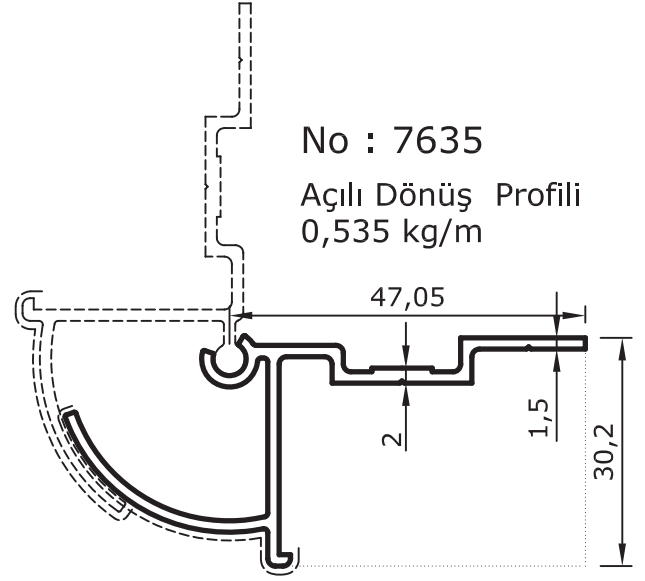
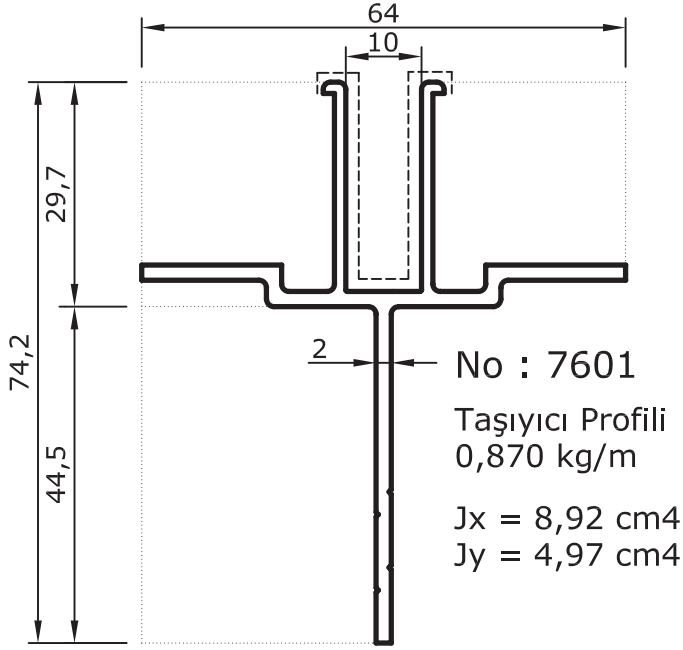

Uyarı: Profil ağırlıklarımız teorik olup; teslim anındaki tartımız geçerlidir.

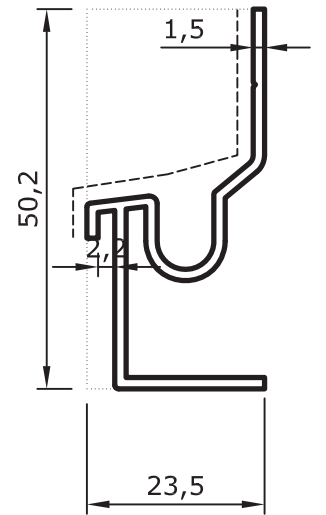
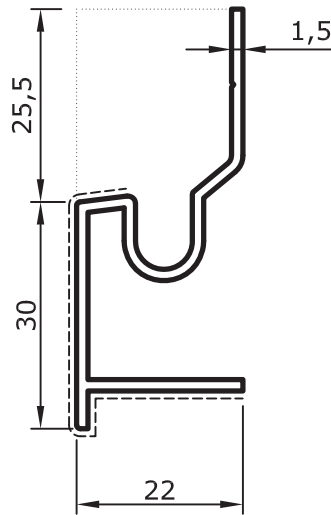
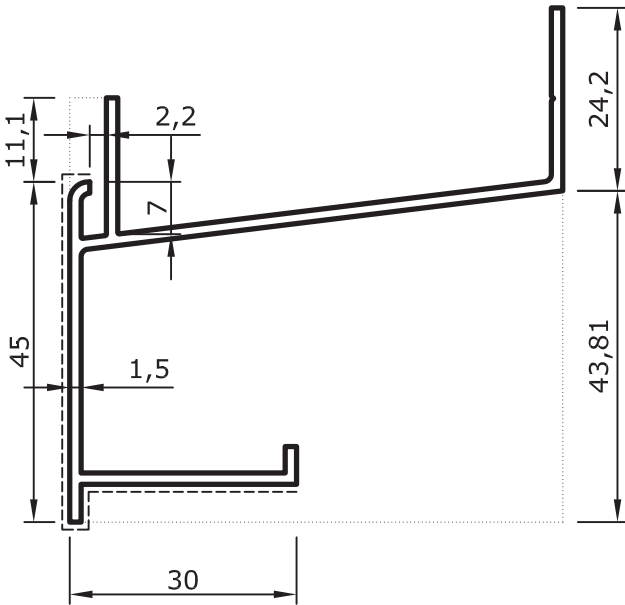
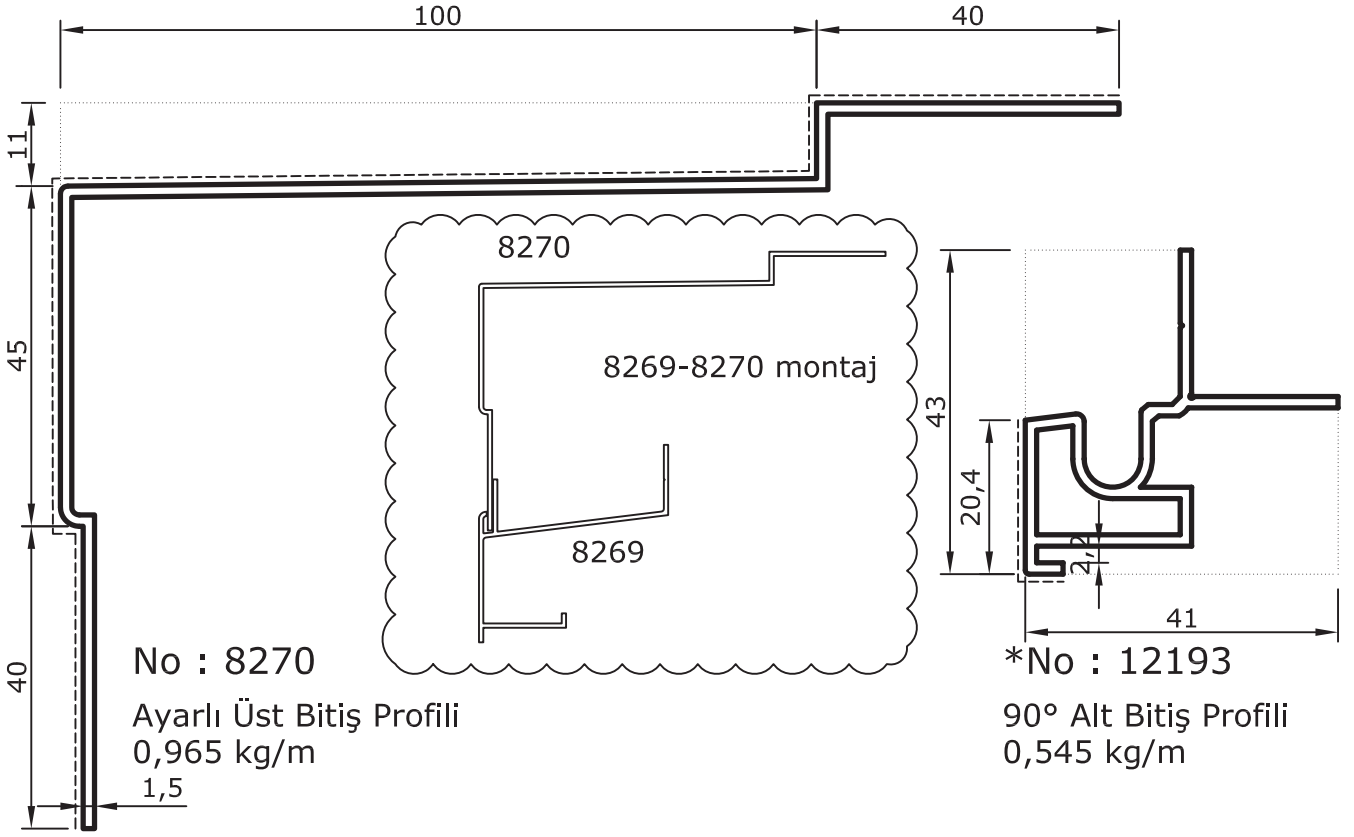

Uyarı: Profil ağırlıklarımız teorik olup; teslim anındaki tartımız geçerlidir.
Warning: the weights of profile is theoretical, weighting at the time of delivery are valid.

* İşaretili kalıp minimum 300 kg üretilir.
* Minimum order quantity: 300 kg

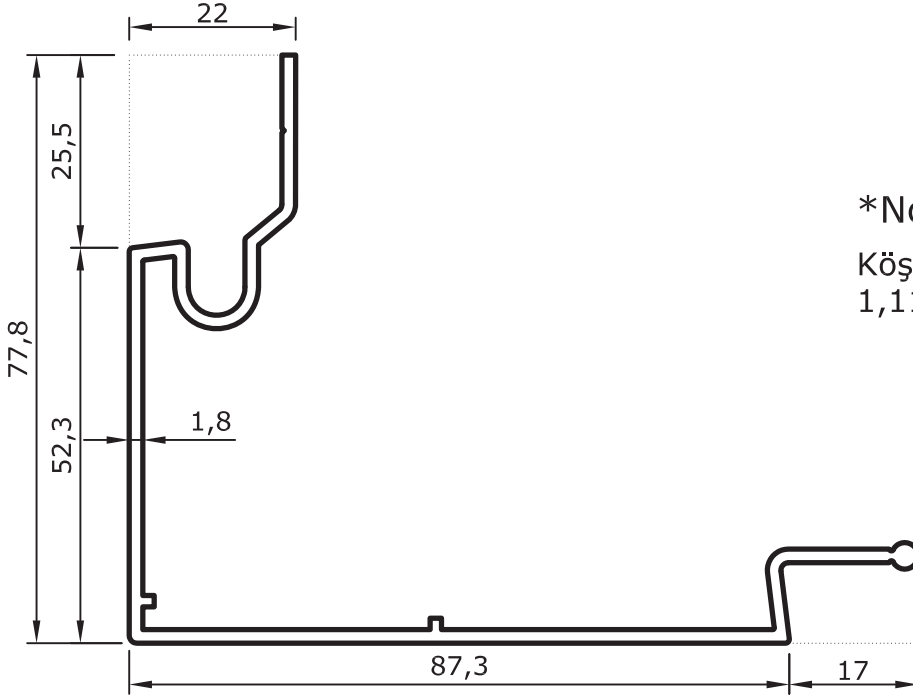

*No : 11856

Köşe Dönüş Lambri Profili
1,110 kg/m

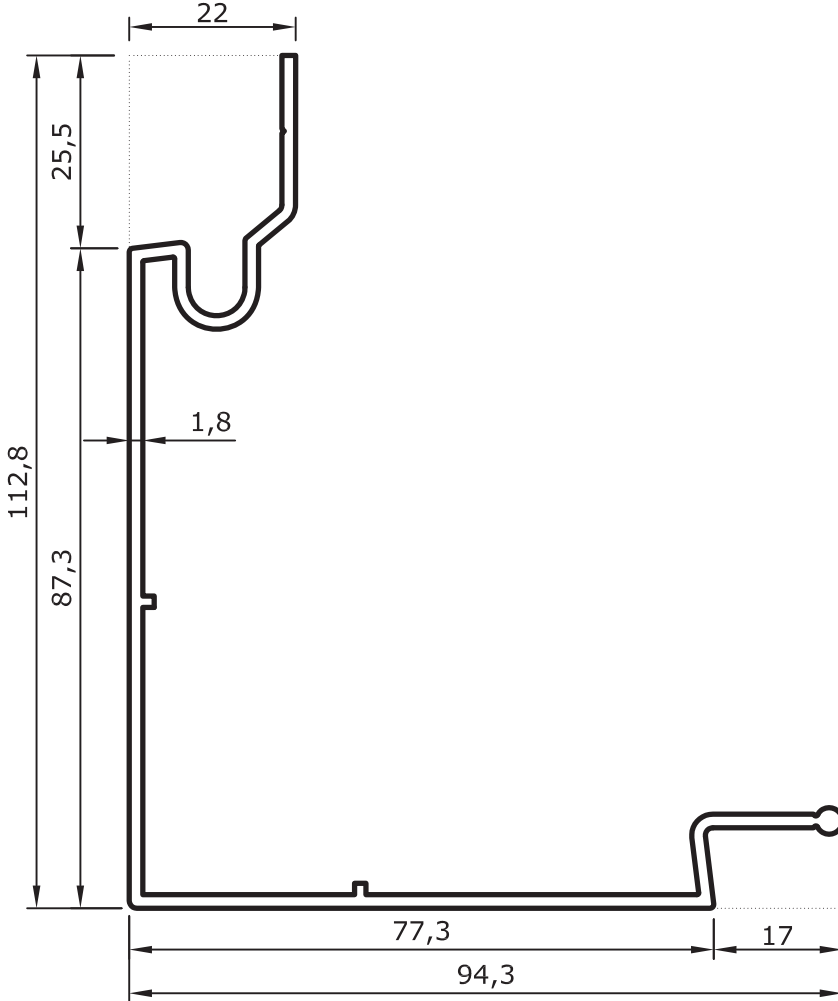

*No : 11857

Köşe Dönüş Lambri Profili
1,235 kg/m

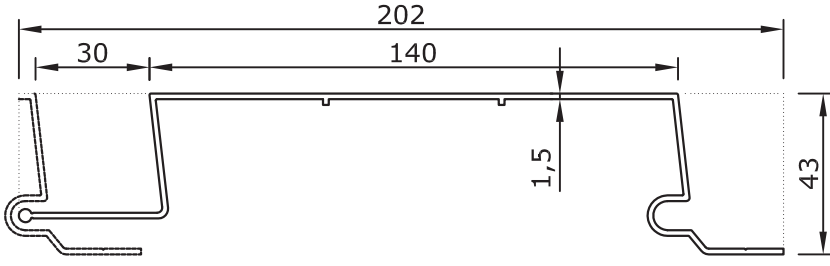

No : 11064
140' lik Cotta Lambri
1,195 kg/m

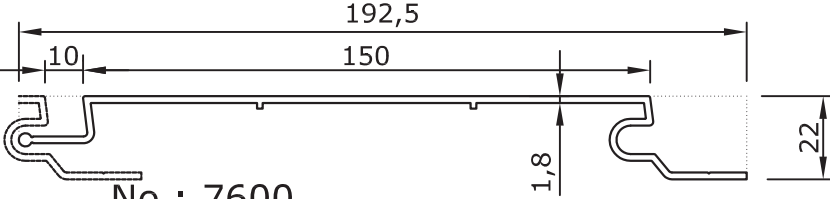

No : 7600
150' lik Cotta Lambri
1,180 kg/m

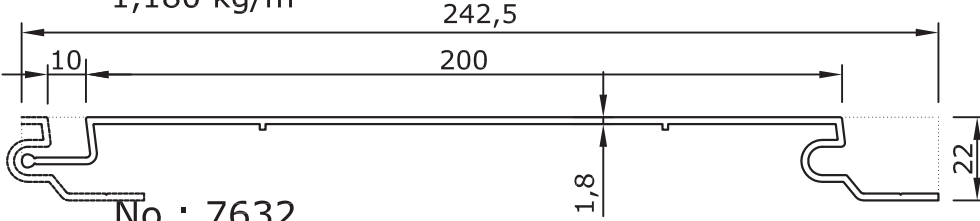

No : 7632
200' lük Cotta Lambri
1,420 kg/m

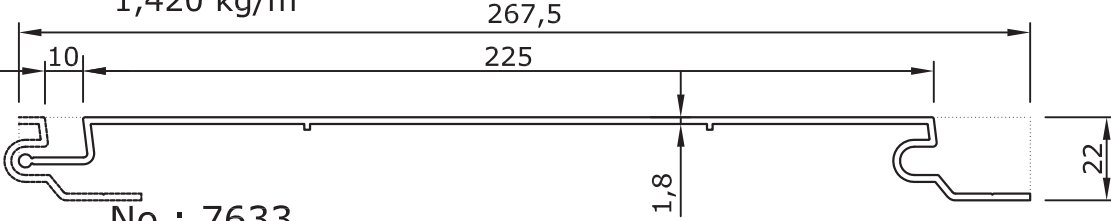

No : 7633
225' lik Cotta Lambri
1,545 kg/m

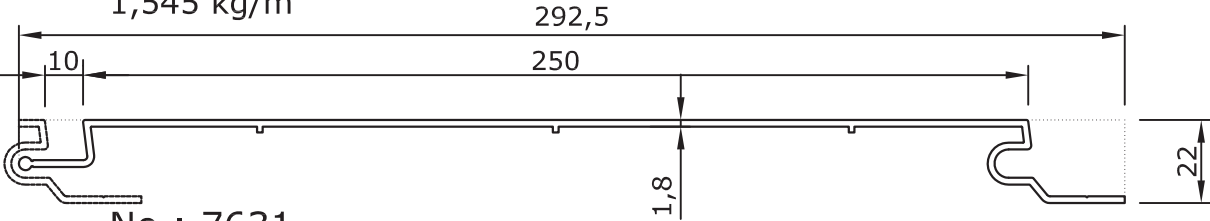

No : 7631
250' lik Cotta Lambri
1,670 kg/m

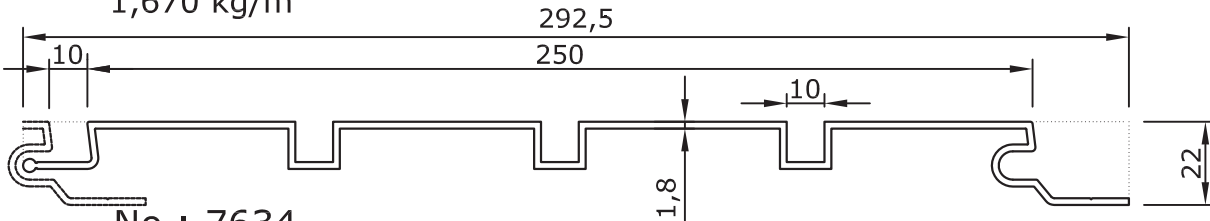

No : 7634
250' lik Fugalı Cotta Lambri
1,965 kg/m

ÖLÇEK : 1/2

Uyarı: Profil ağırlıklarımız teorik olup, teslim anındaki tartımız geçerlidir.
Warning: the weights of profile is theoretical, weighting at the time of delivery are valid.

L BRAKETLER

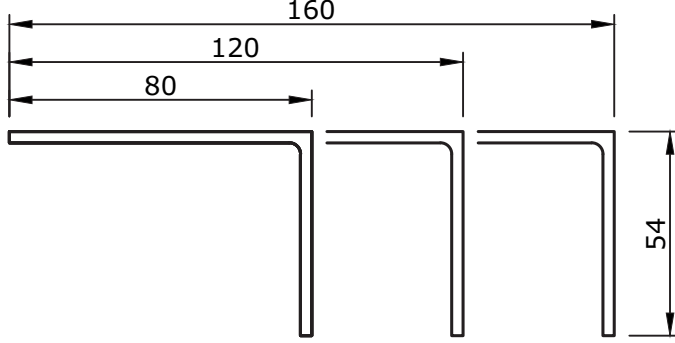

No : 4747	No : 4748	No : 4749
54X80 L	54X120 L	54X160 L
1,075 kg/m	1,400 kg/m	1,725 kg/m

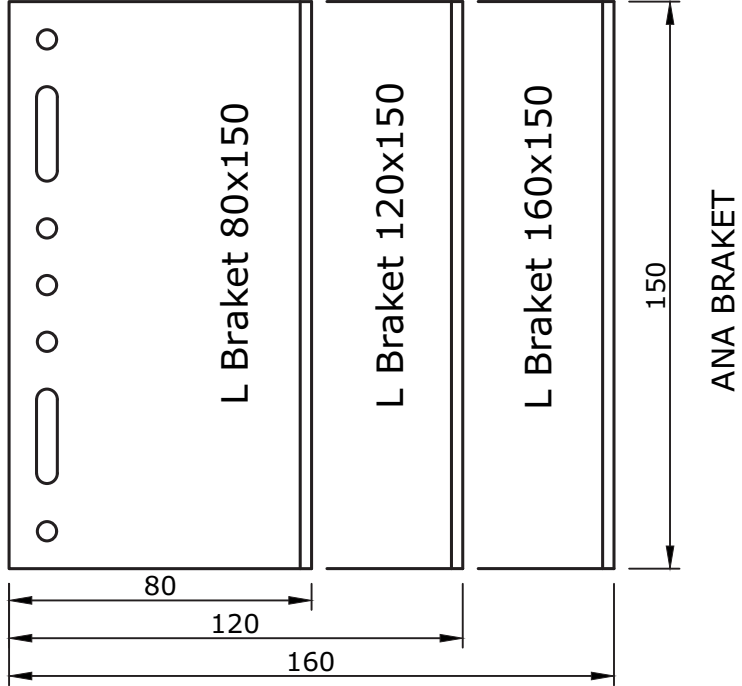
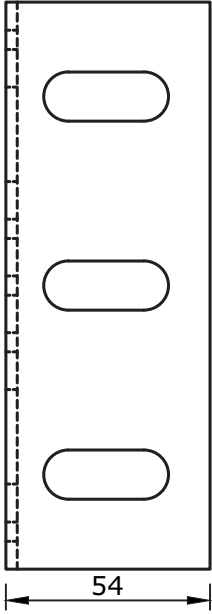
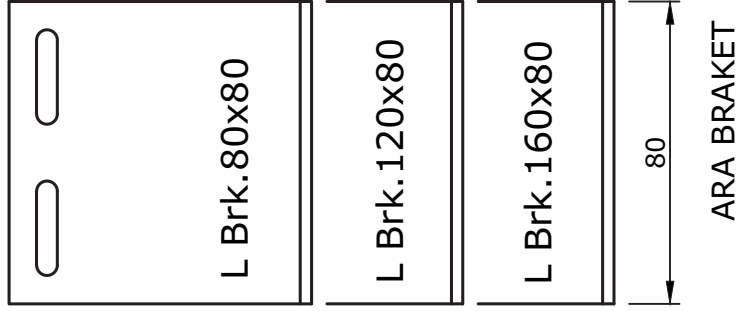
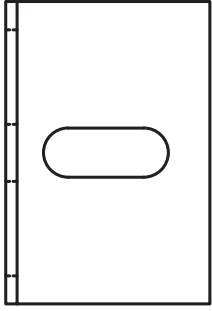

YAN GÖRÜNÜŞ

ÖN GÖRÜNÜŞ

ÖLÇEK: 1/2

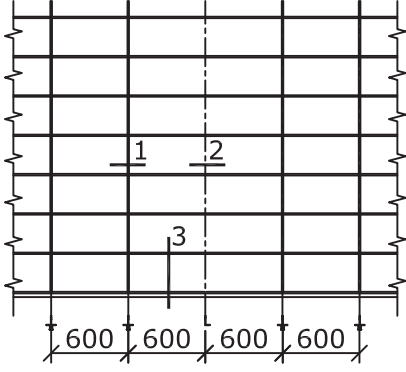

GÖRÜNÜŞ

Detay
Detail 1

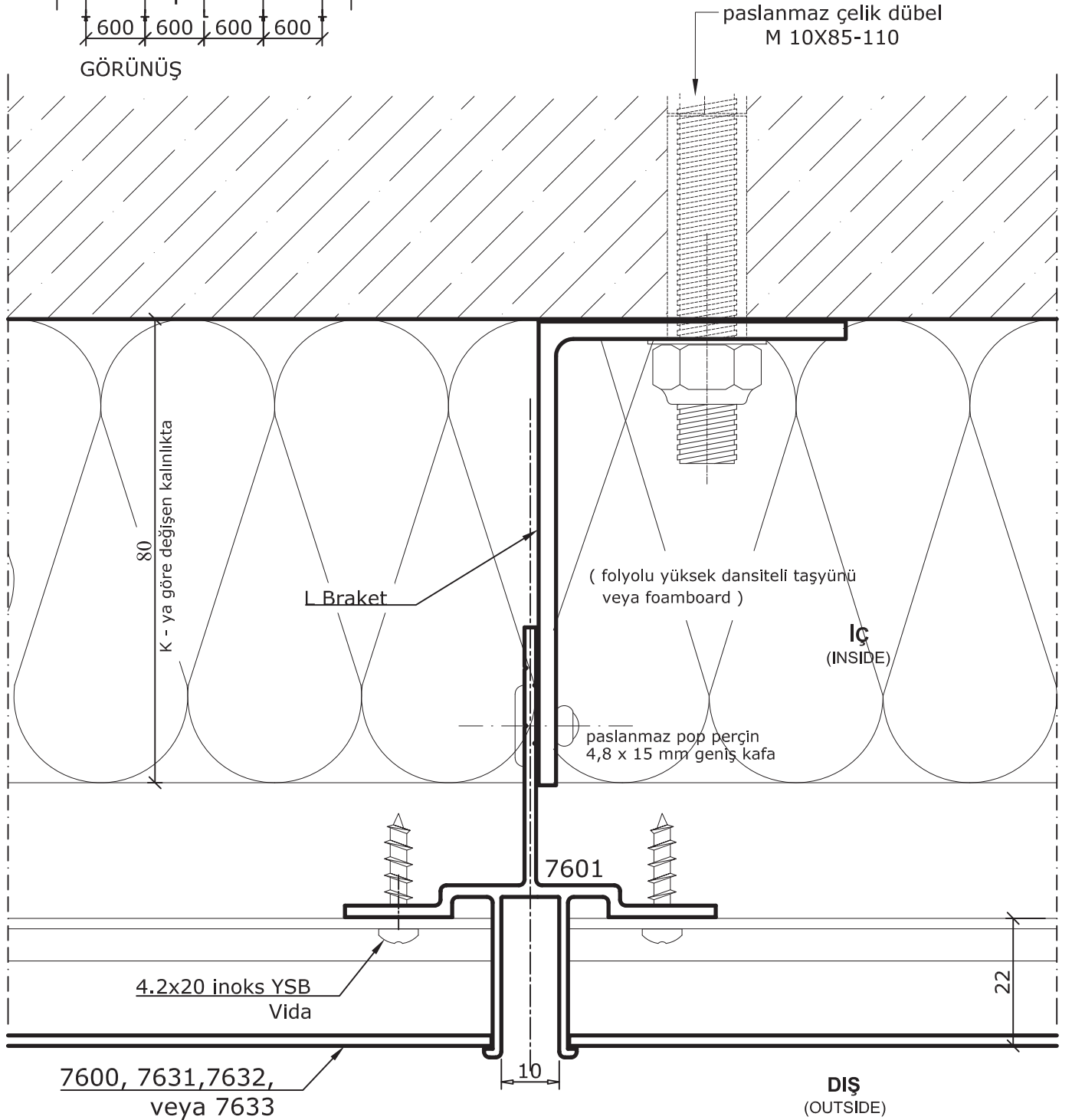

ÖLÇEK : 1/2

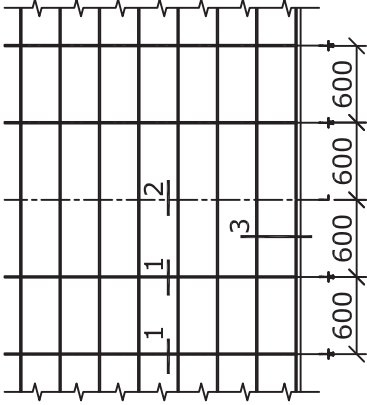

GÖRÜNÜŞ

paslanmaz çelik dübel
M 10X85-110

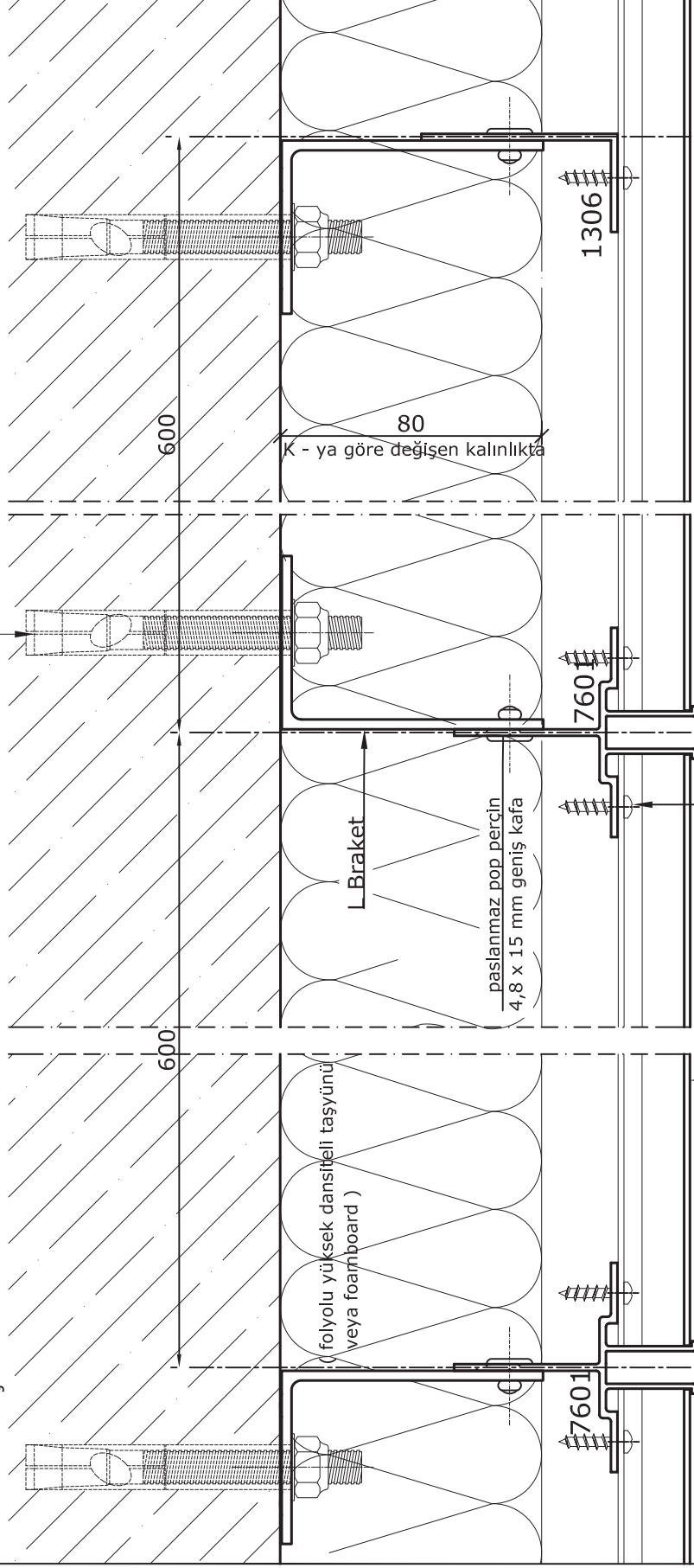

Detail 2
Detail

Detail 1
Detail

Detail 1
Detail

7600, 7631, 7632
veya 7633

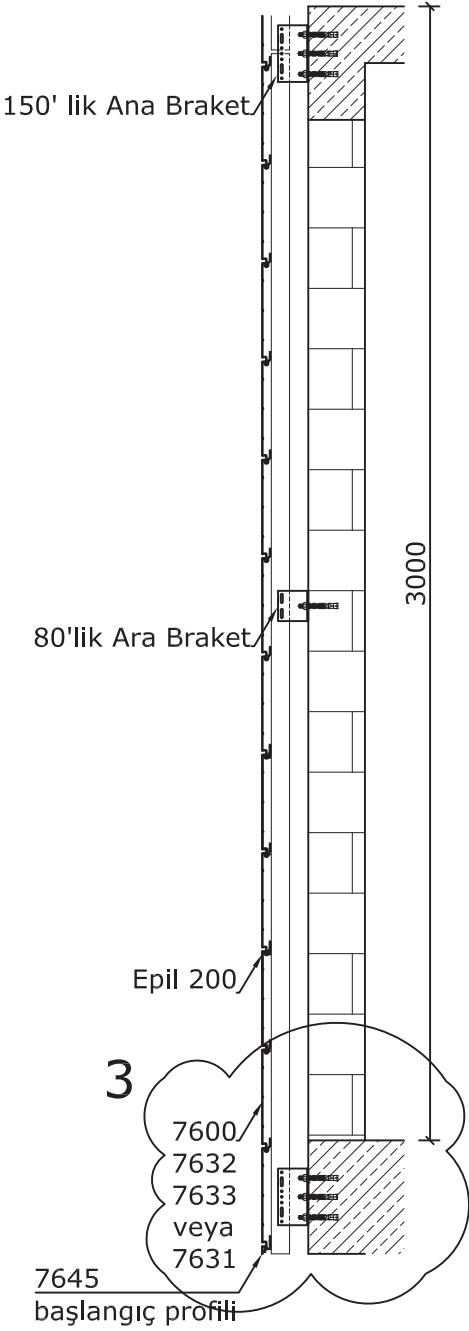
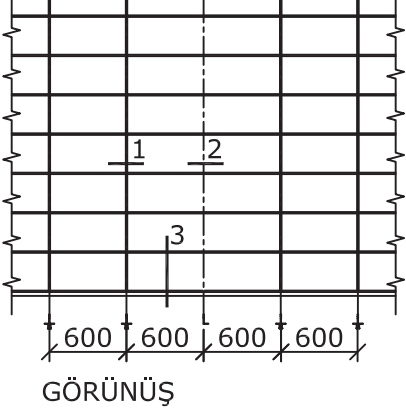

ALT BAŞLANGIÇ DETAYI

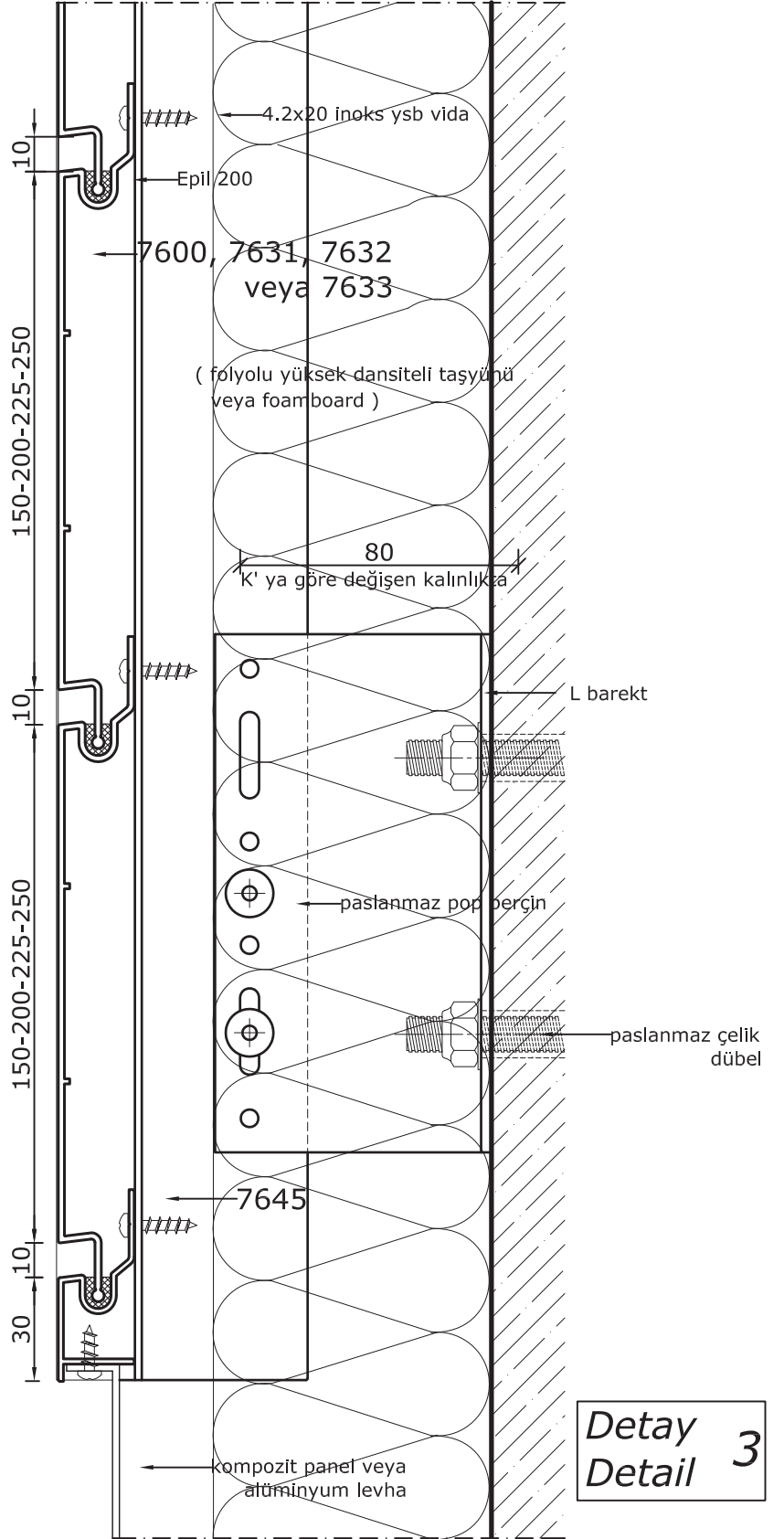

Detay
Detail 3

Ölçek: 1/2

ÜST BİTİŞ DETAYI

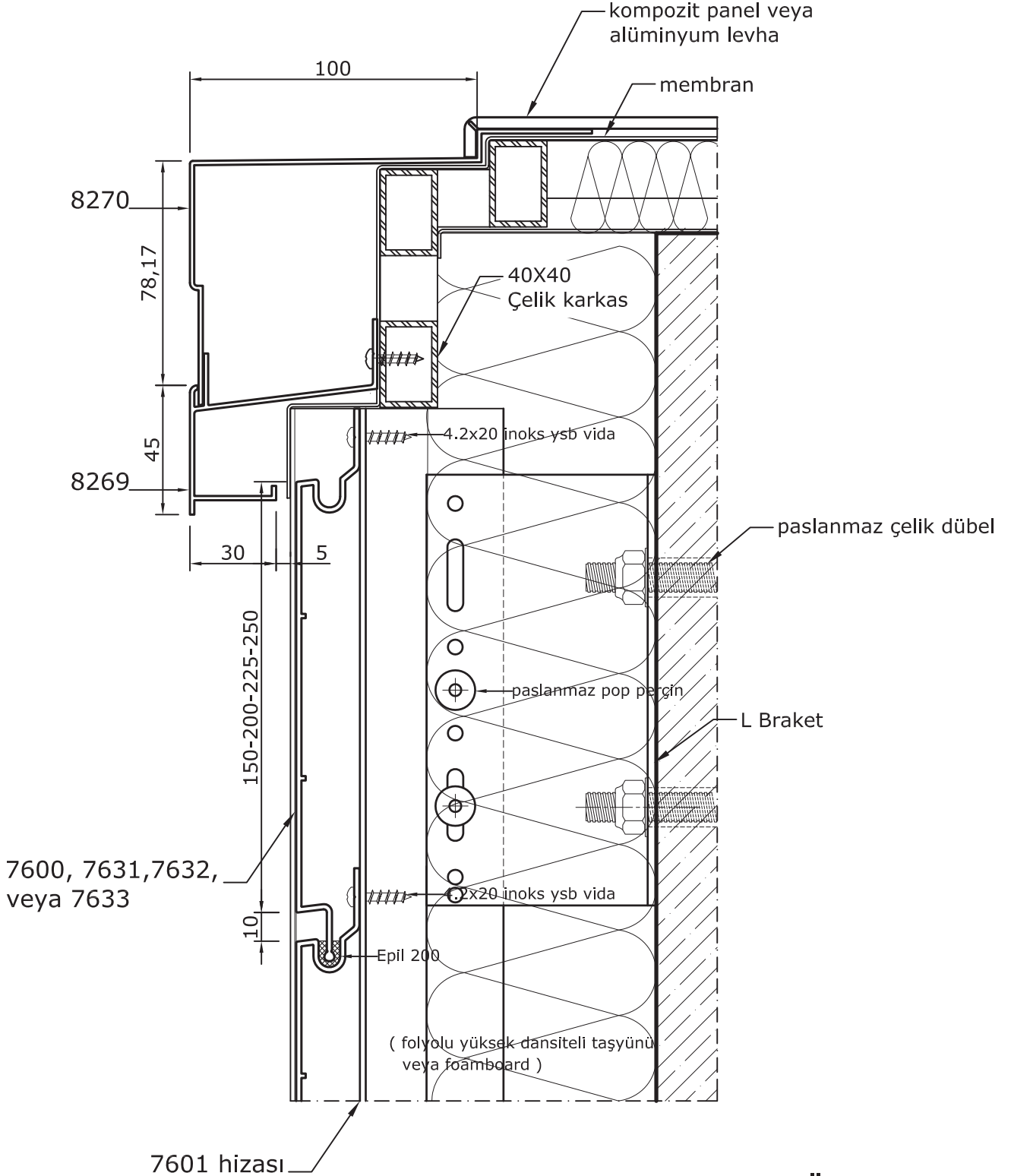

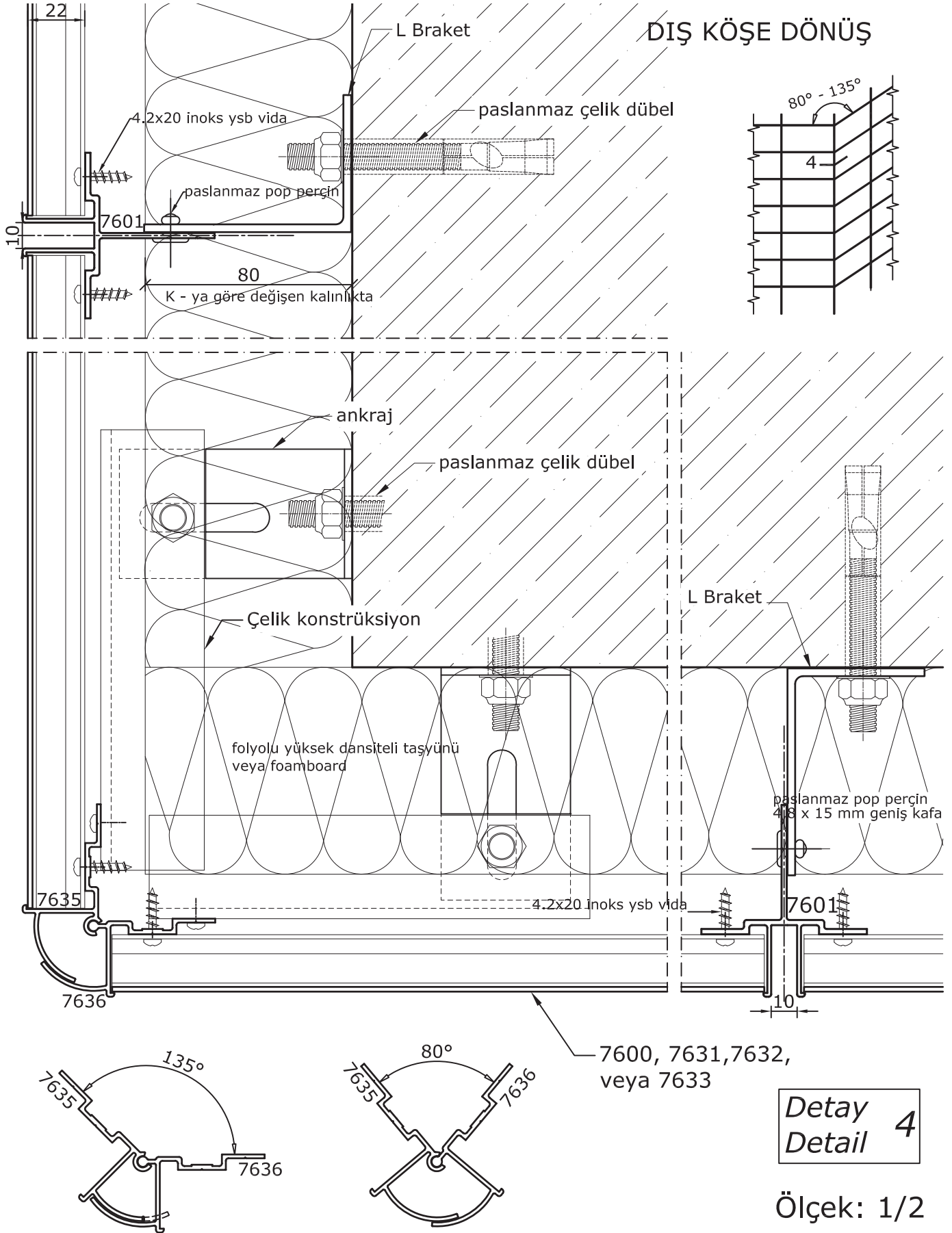

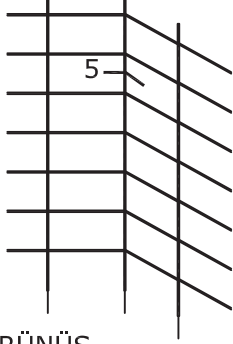

İÇ KÖŞE DÖNÜŞ

GÖRÜNÜŞ

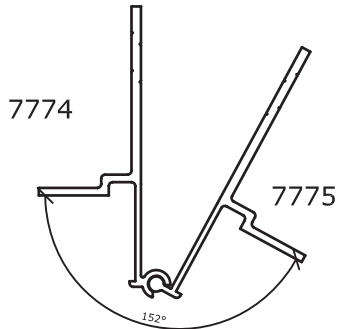
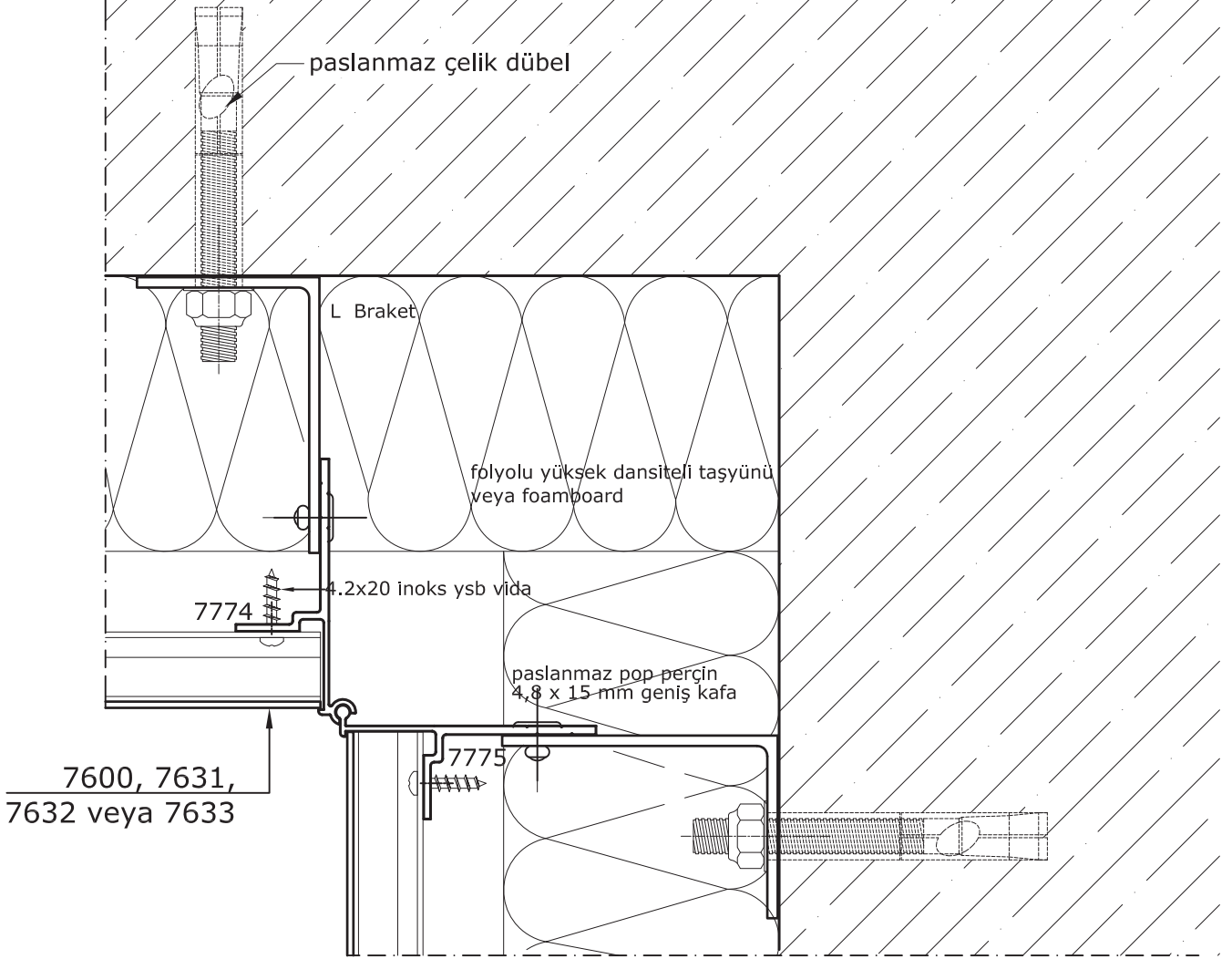

Detay 5
Detail 5

Ölçek: 1/2

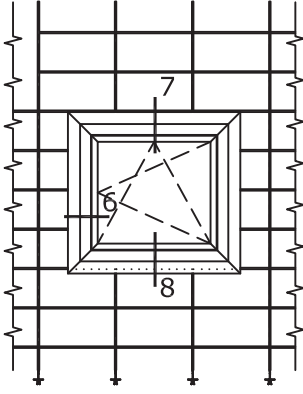

GÖRÜNÜŞ

PENCERE SÖVE DETAYI

Detail
Detail 6

İÇ
(INSIDE)

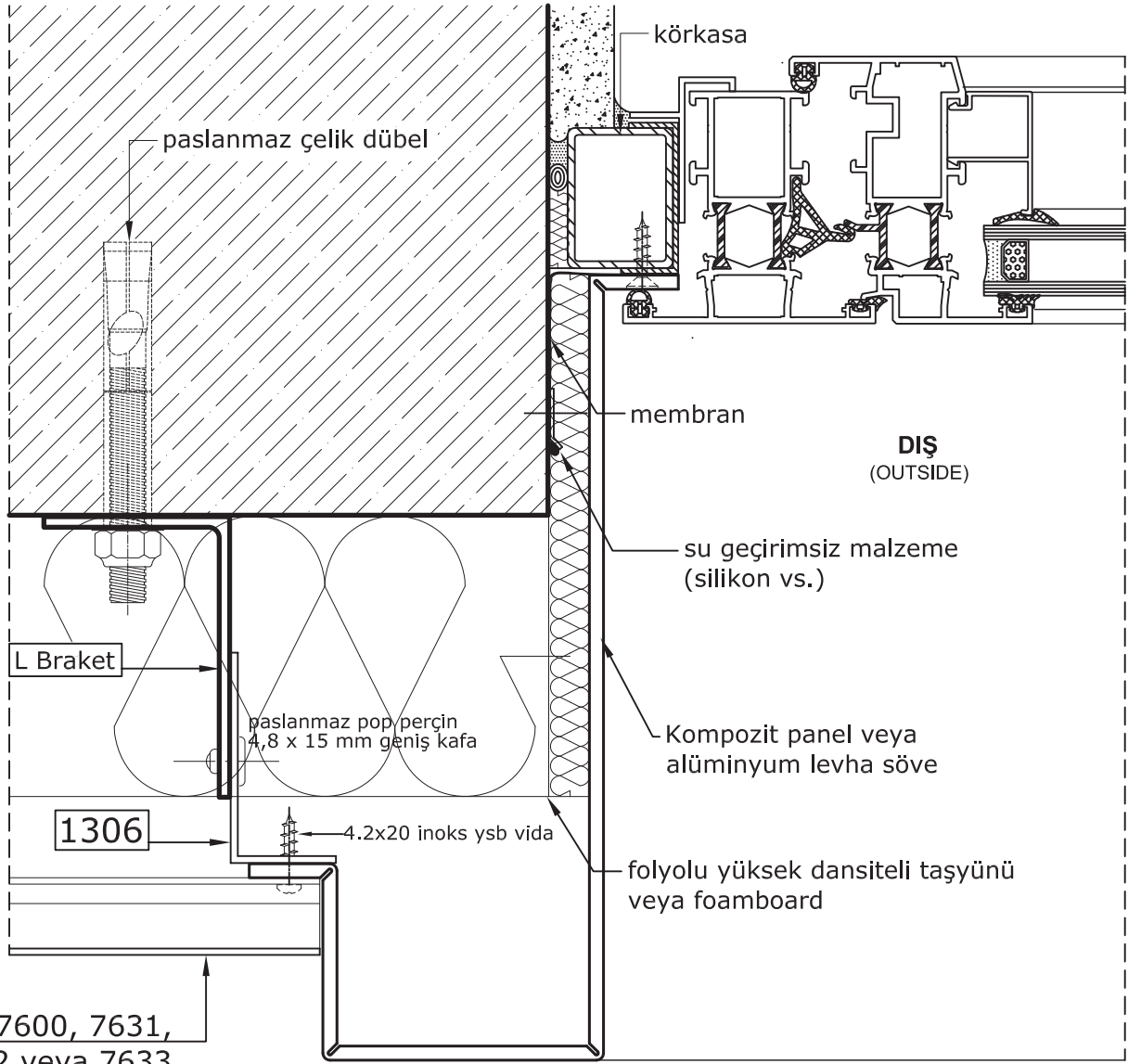

7600, 7631,
7632 veya 7633

Ölçek: 1/2

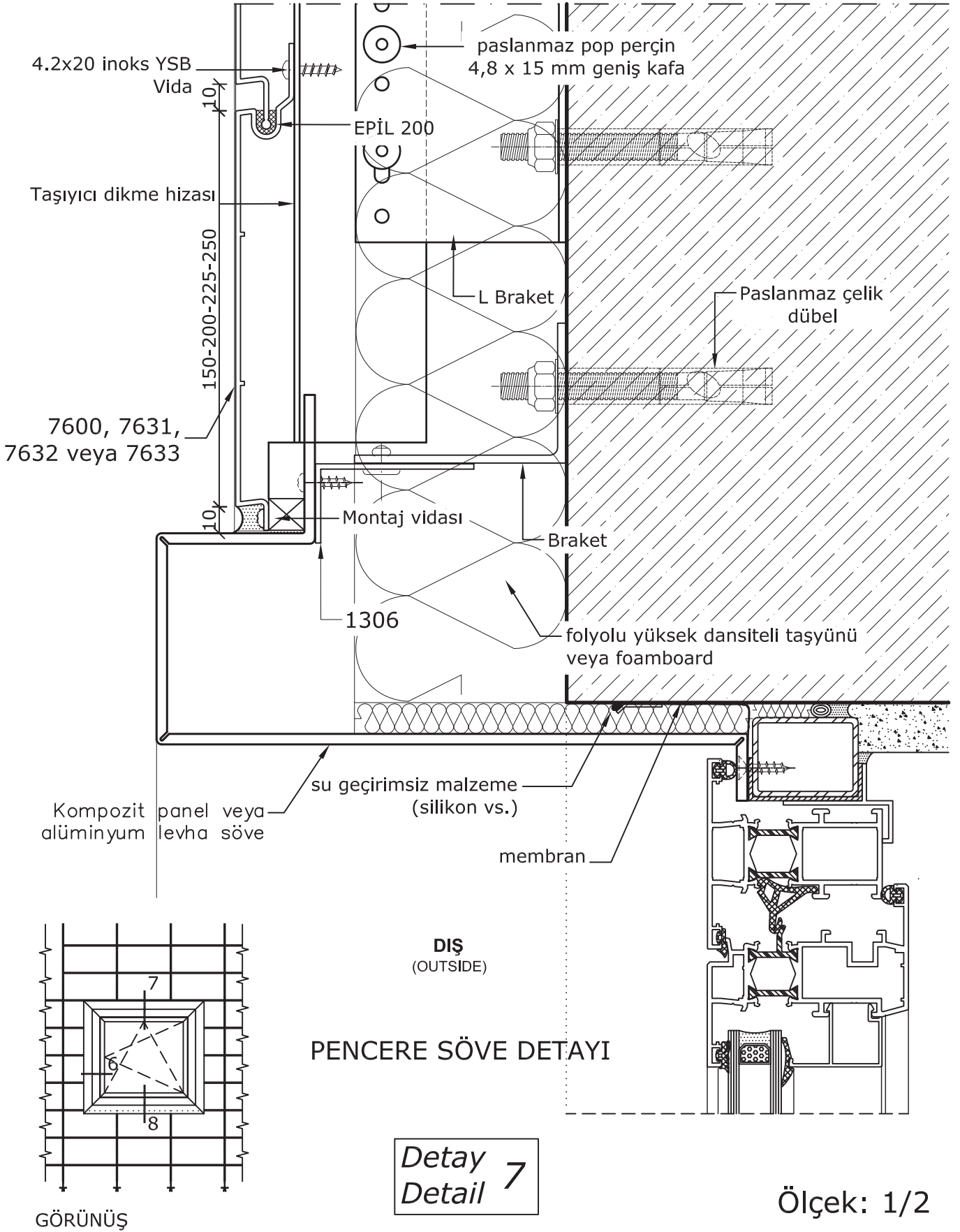

PENCERE SÖVE DETAYI

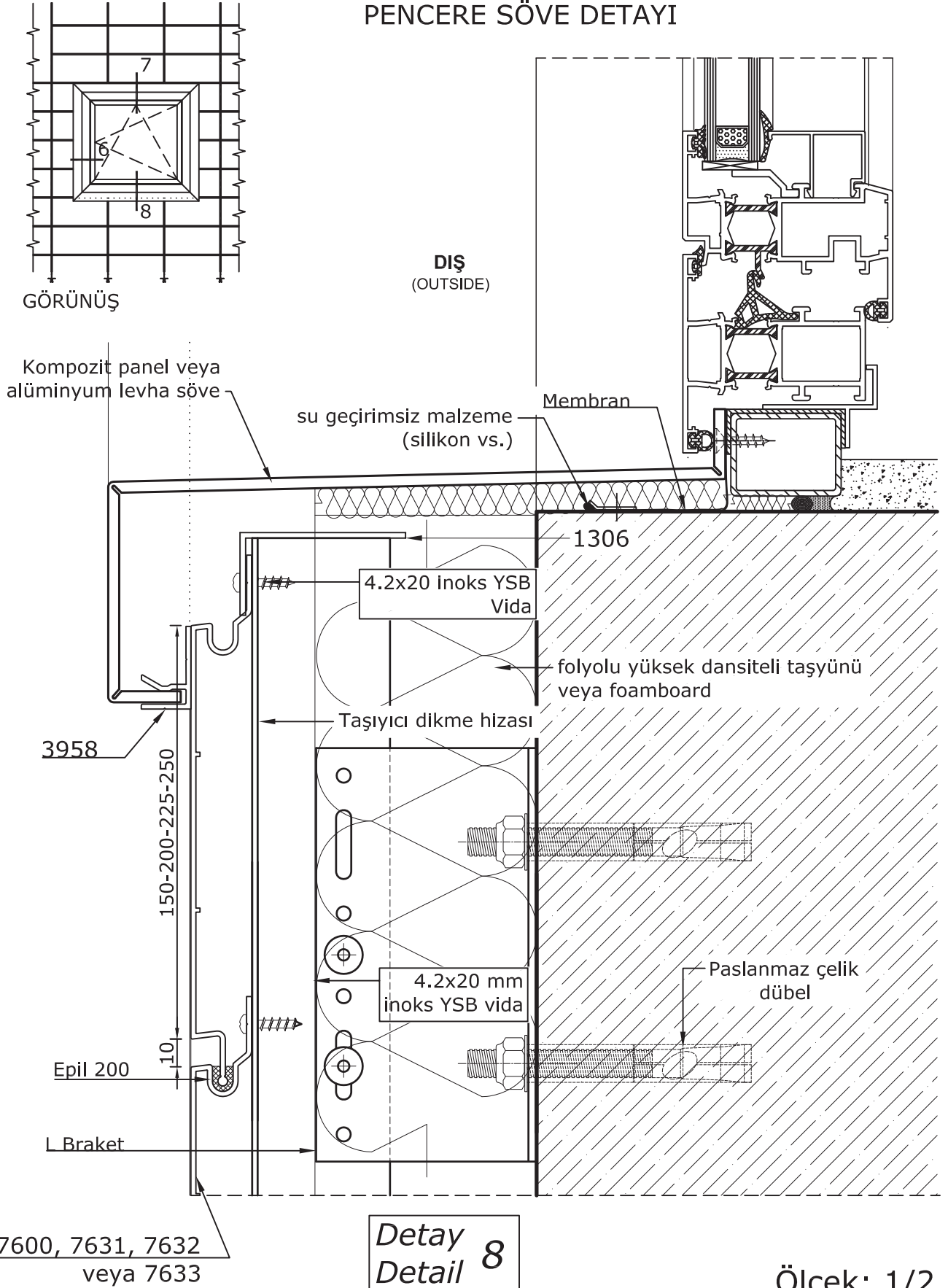

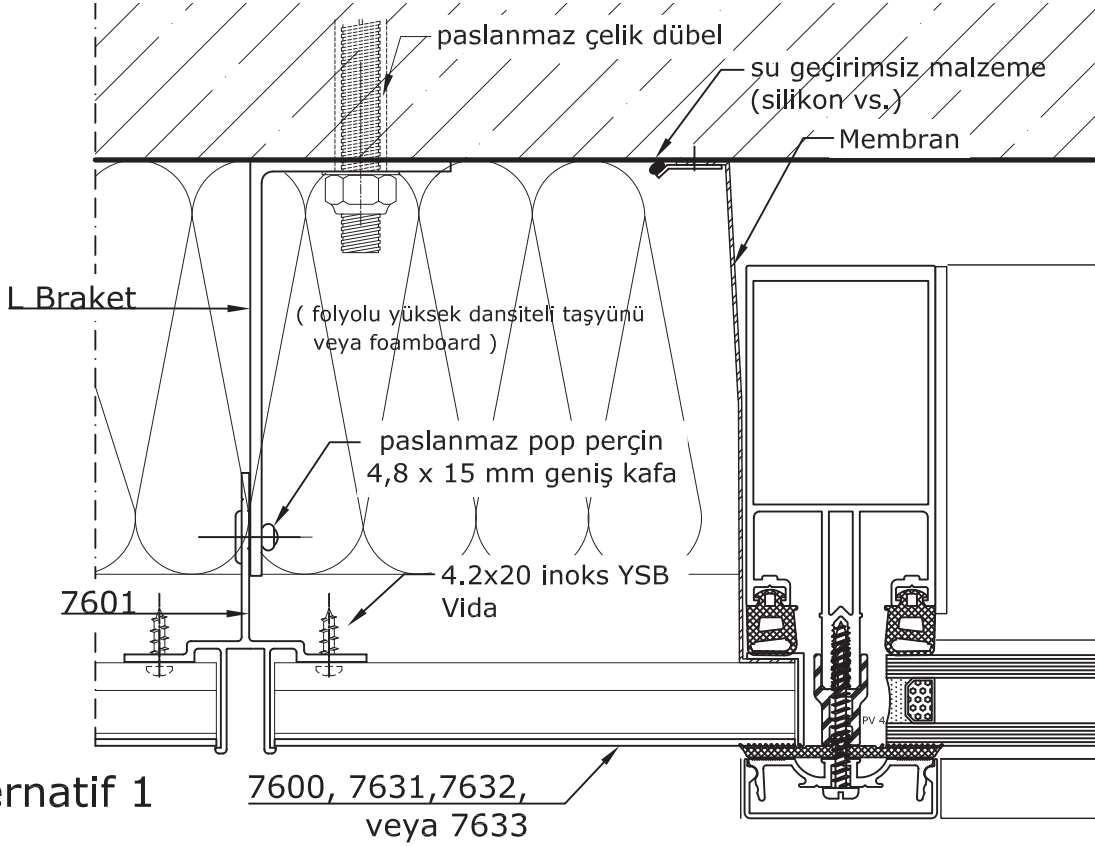

-GİYDİRME CEPHE BİTİŞ DETAYLARI-

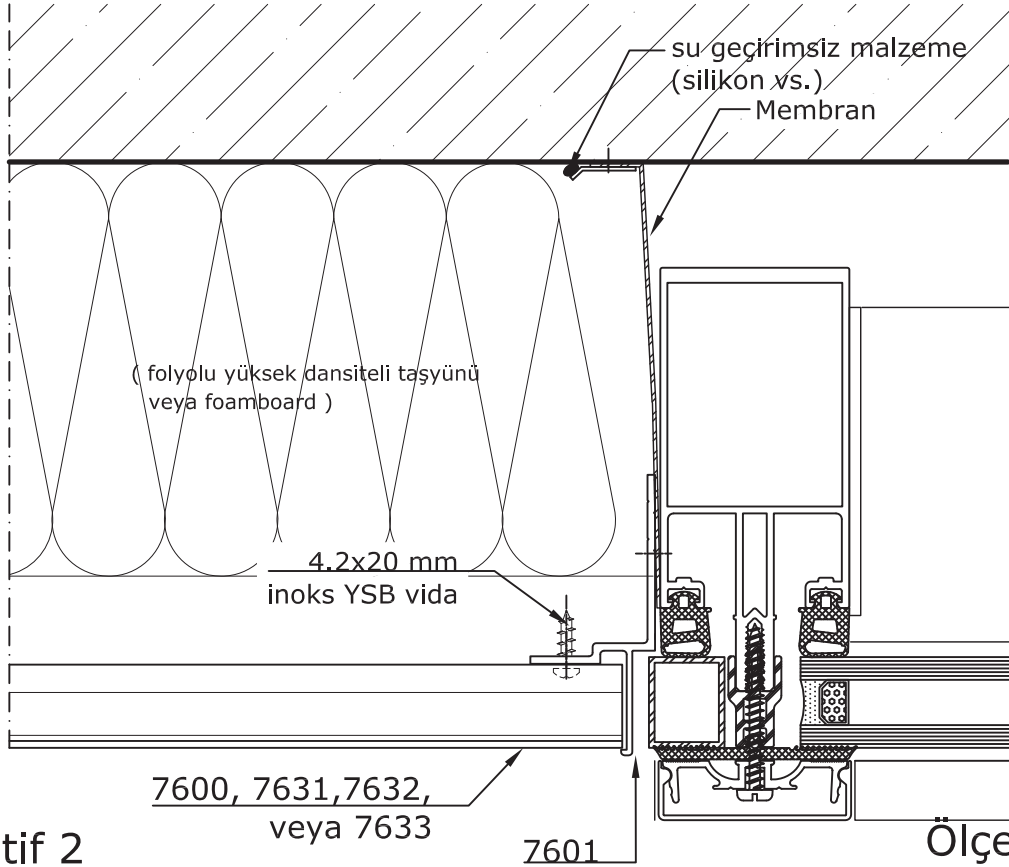

Ölçek: 1/2

-GİYDİRME CEPHE BİTİŞ DETAYLARI-

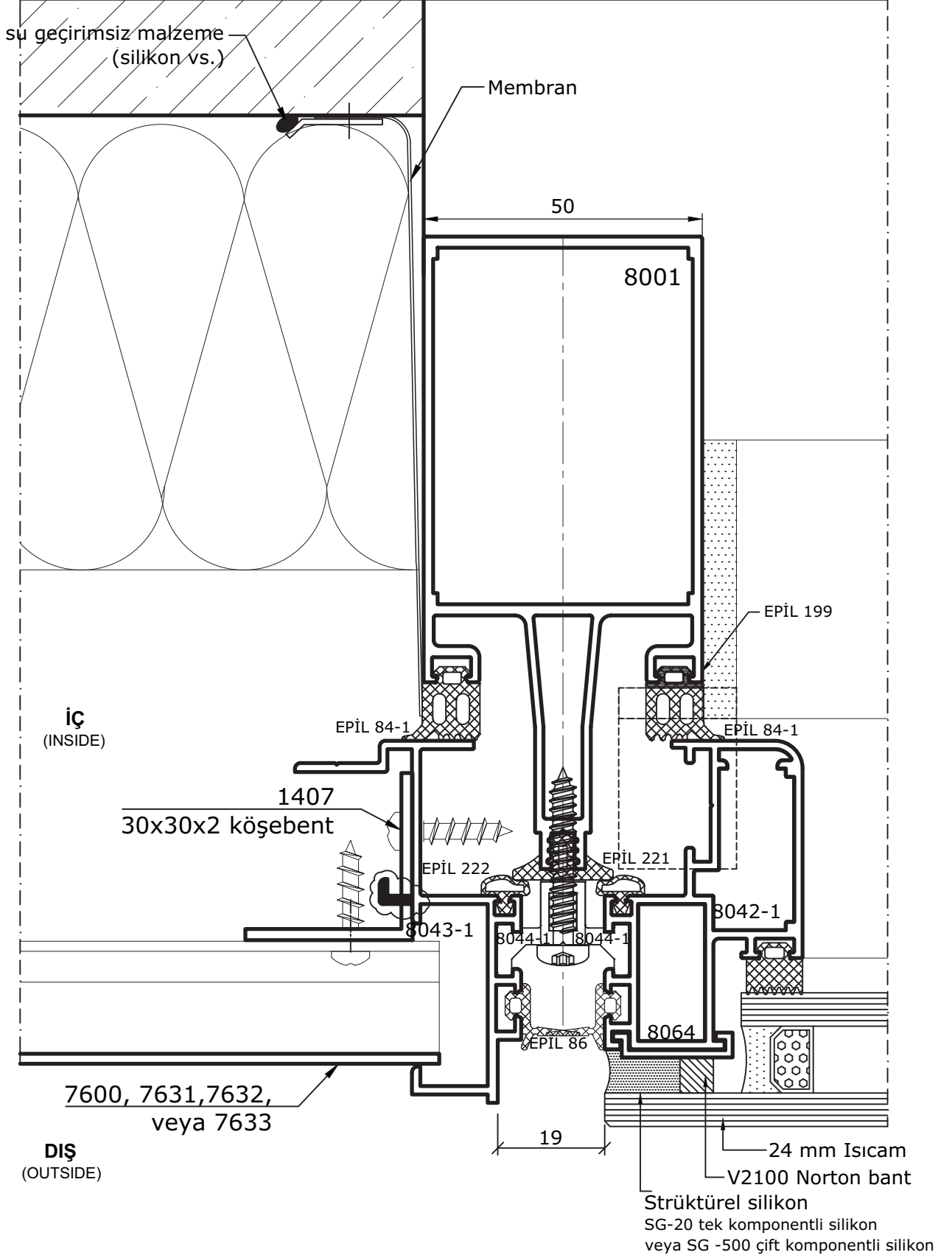

DUVAR BİTİŞ DETAYI

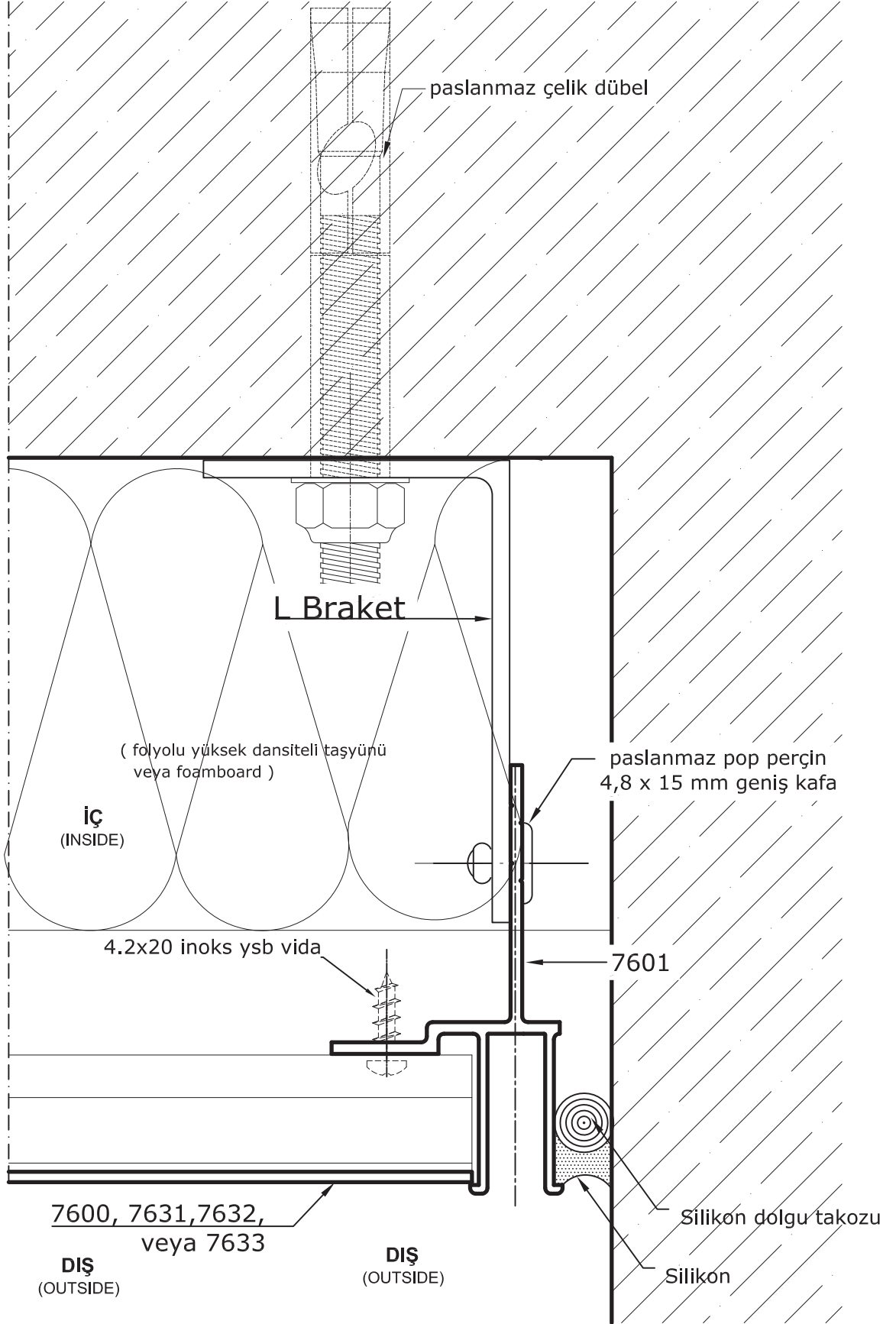

DUVAR BİTİŞ DETAYI

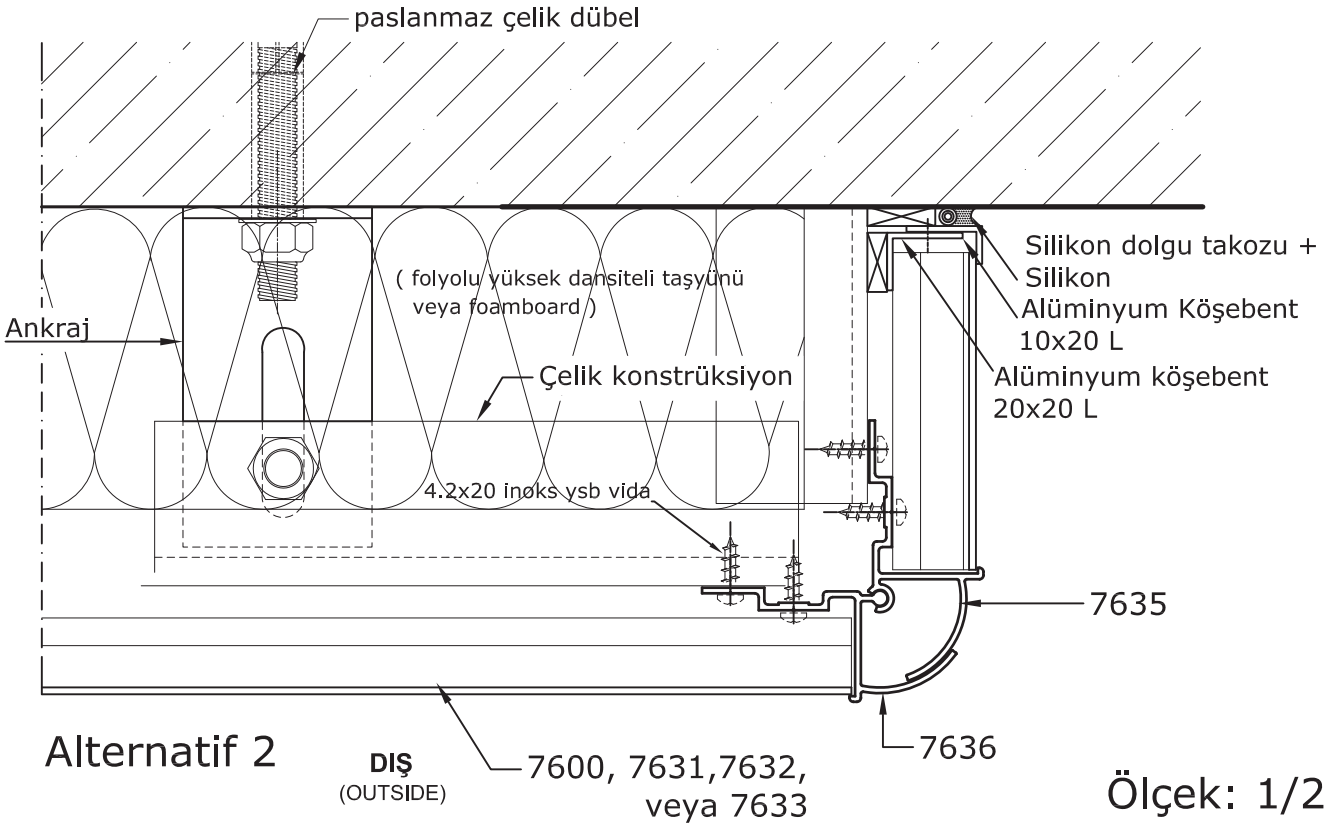
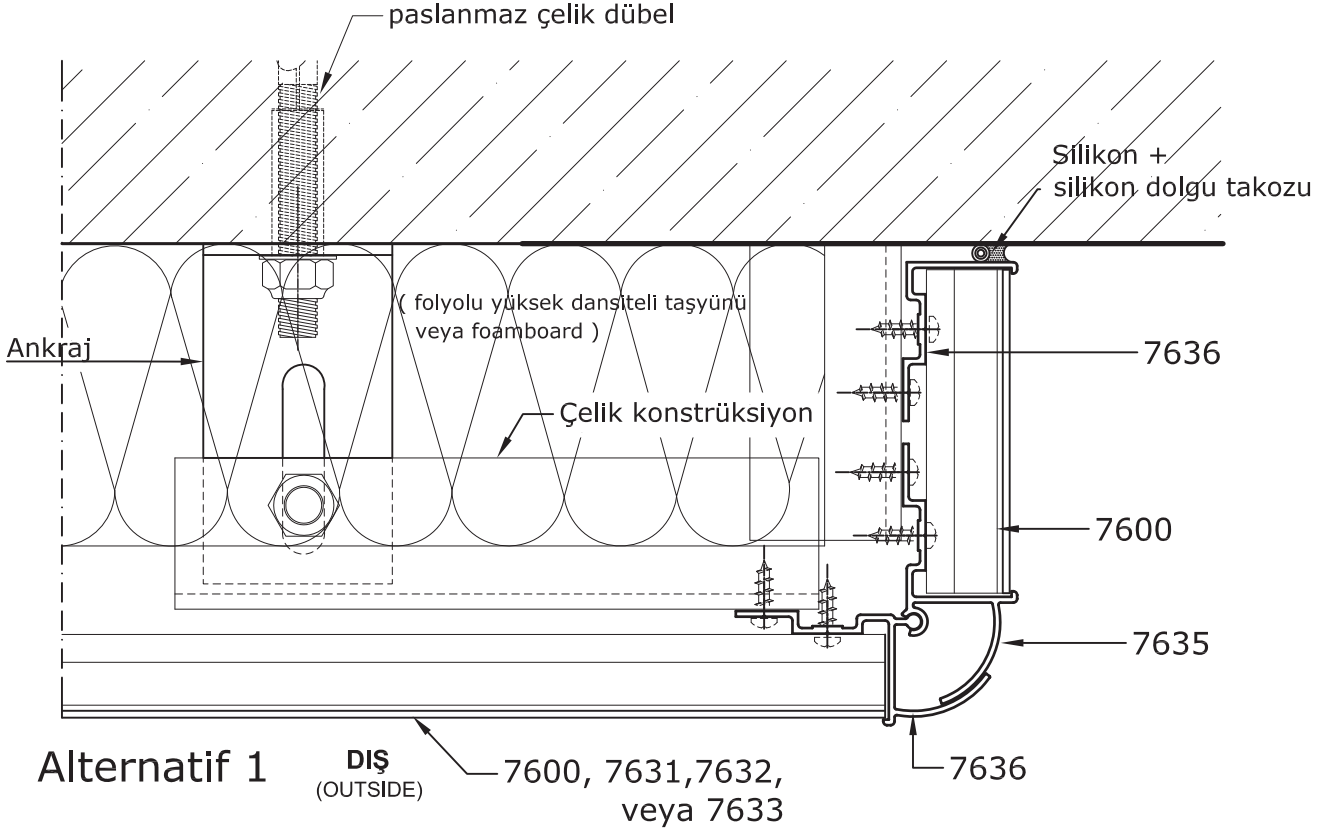

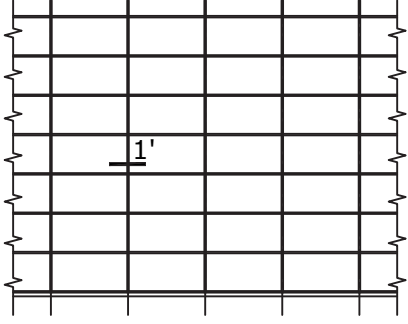

GÖRÜNÜŞ

ÇELİK KONSTRÜKSİYONLU SİSTEM

Detay 1'
Detail 1'

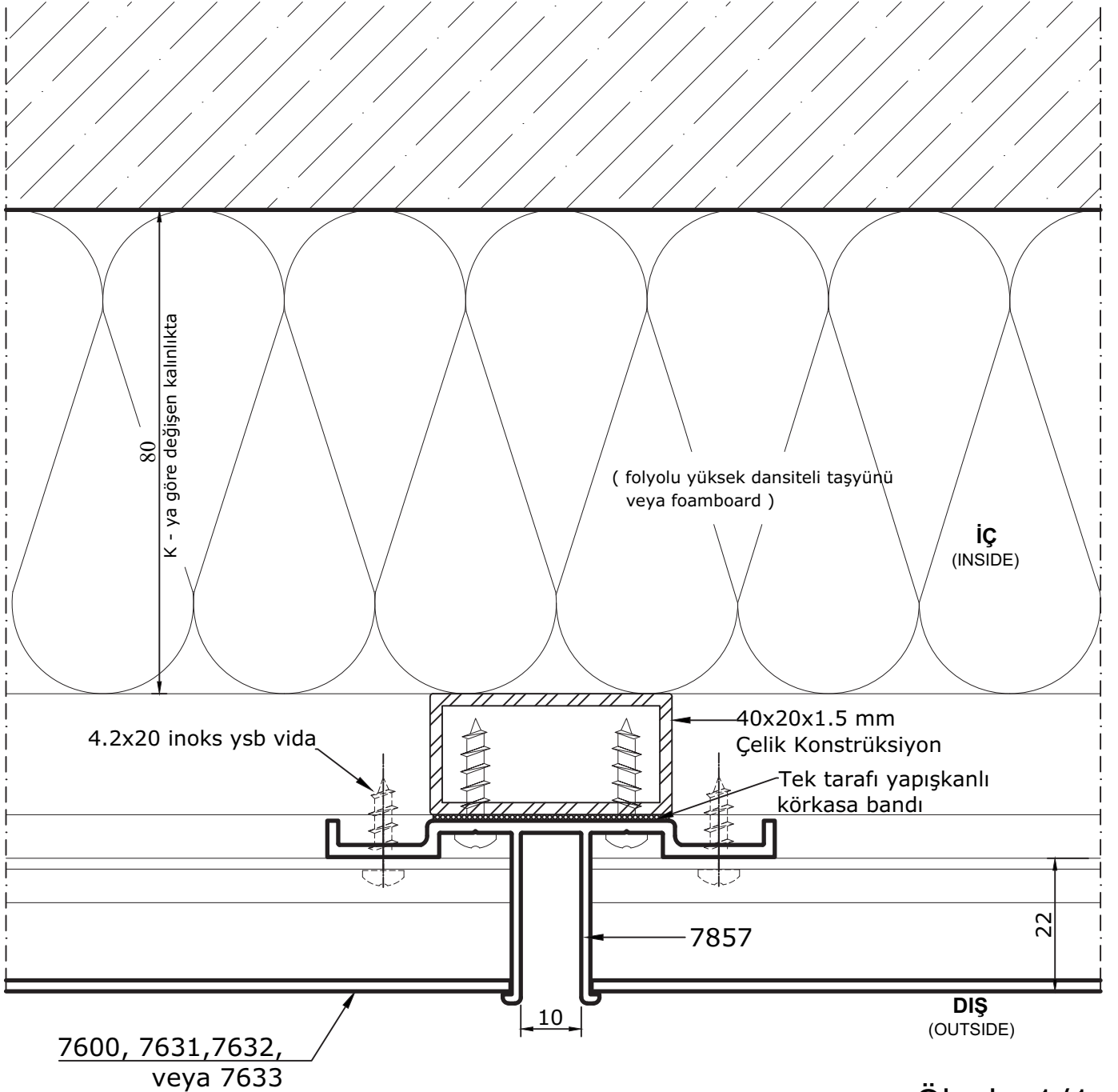

Dikkat: Sistem taşıyıcı sistem hesabı statiker tarafından yaptırılmalıdır.

Ölçek: 1/1

SARAY COTTA PERSPEKTİF

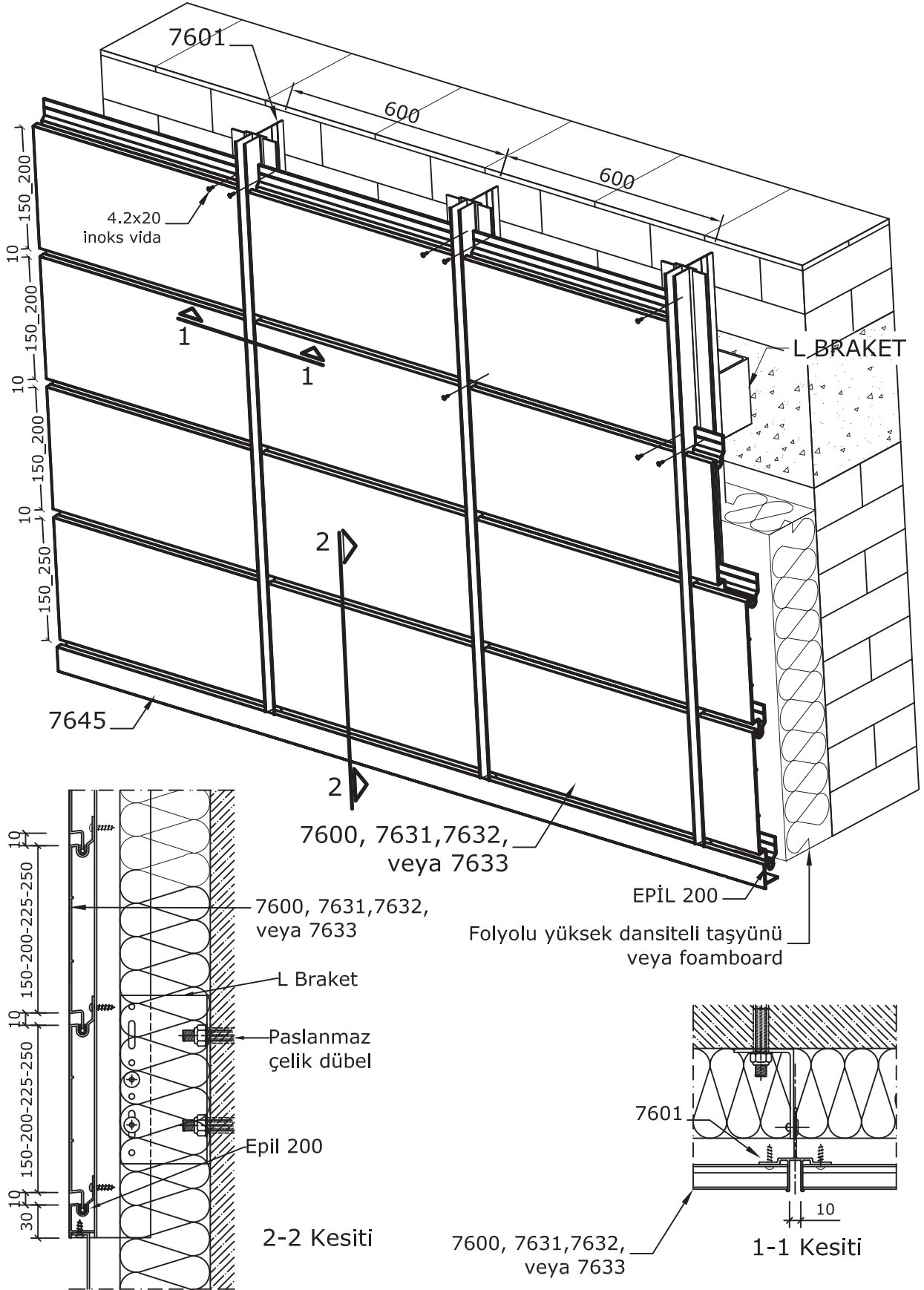

SARAY COTTA PERSPEKTİF YATAY DÜŞEY DERZLİ SİSTEM

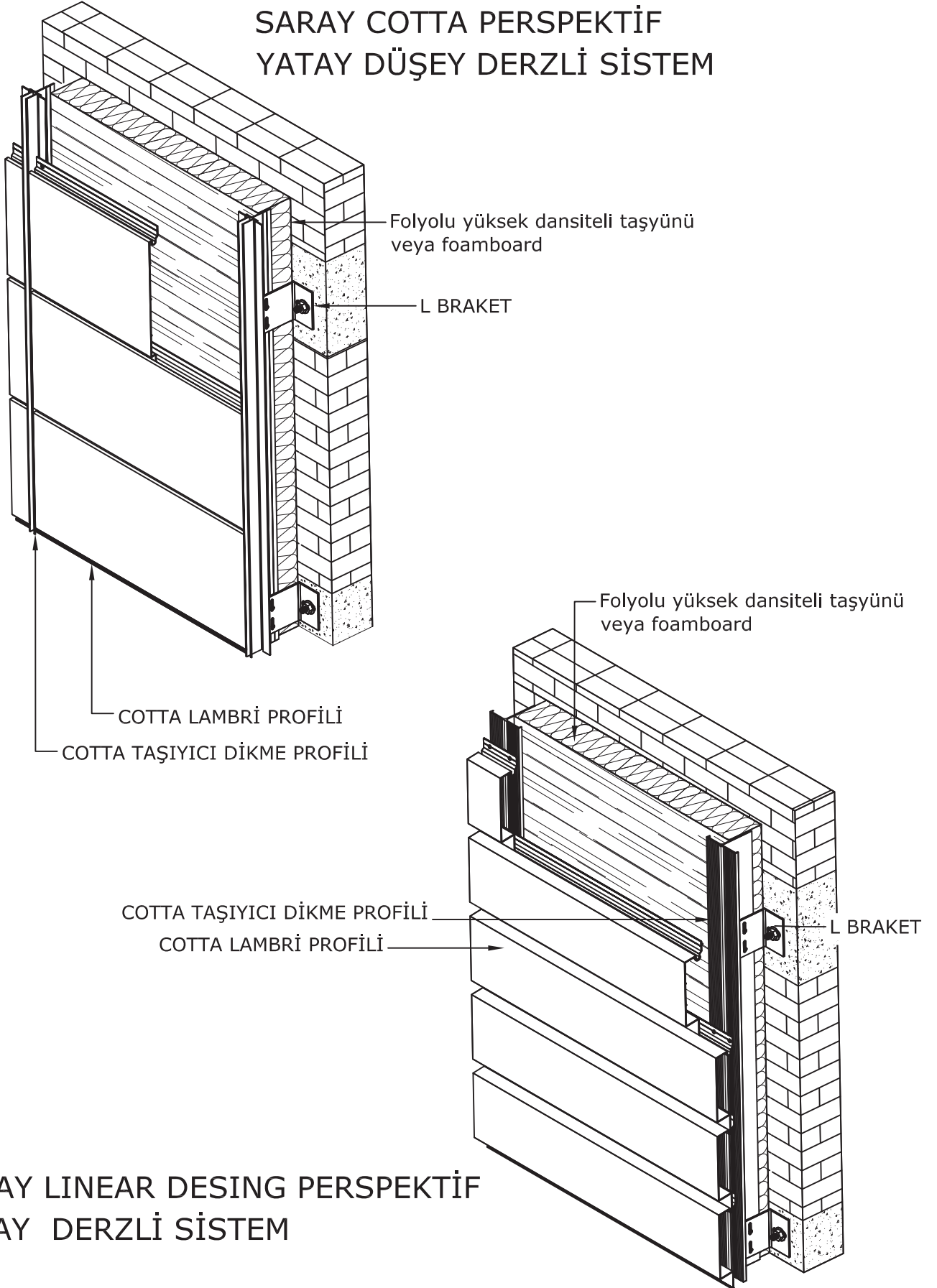

SARAY LINEAR DESİNG PERSPEKTİF YATAY DERZLİ SİSTEM