

ALFA

GİZLİ KANATLI PENCERE ve KAPI SİSTEMİ CONCEALED SASH WINDOW and DOOR SYSTEM

A	ALUMİNYUM PROFİLLER ALUMINIUM PROFILES	A-01 / A-06
B	CAM MONTAJ TALİMATI GLAZING ASSEMBLY	B-01 / B-04
C	CONTALAR GASKETS	C-01 / C-02
D	AKSESUARLAR ACCESSORIES	D-01 / D-04
E	TAM ÖLÇEKLİ PROFİLLER FULL SCALE PROFILES	E-01 / E-21
F	PRENSİP SİSTEM DETAYLARI PRINCIPAL SECTIONS	F-01 / F-133
G	ÜRETİM TALİMATLARI MANUFACTURING INSTRUCTIONS	G-01 / G-48



A L F A



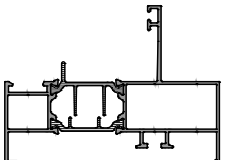
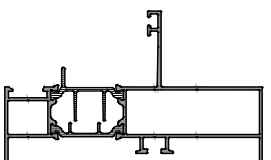
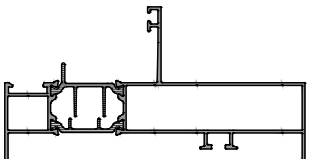
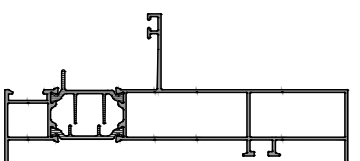
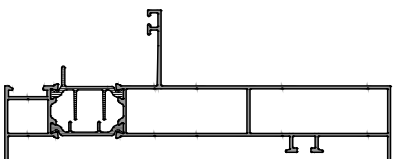
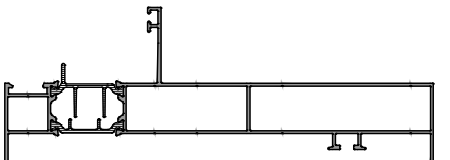
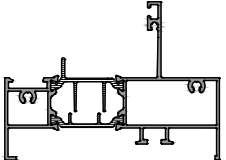
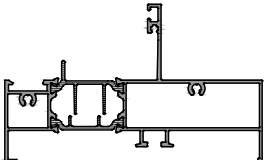
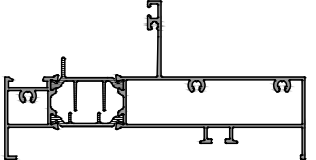
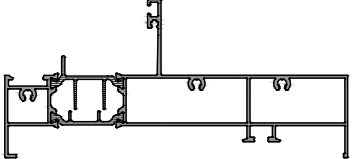

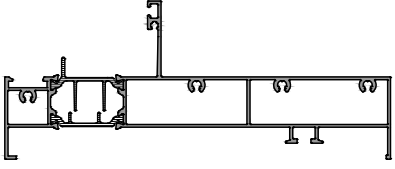
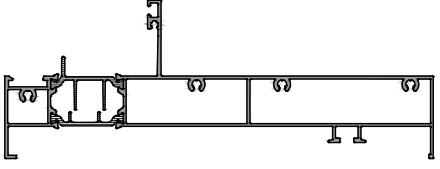
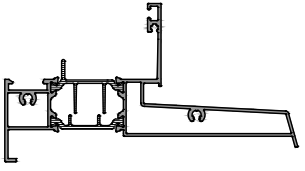
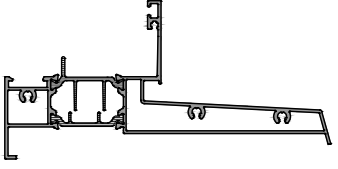
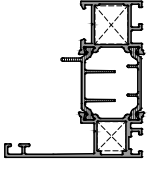
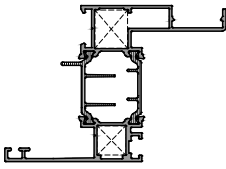
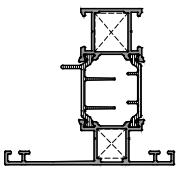
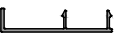
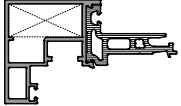
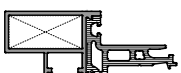

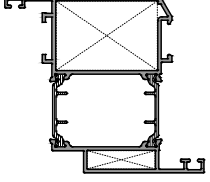
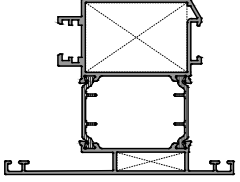
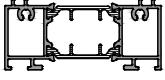
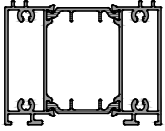
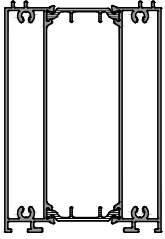
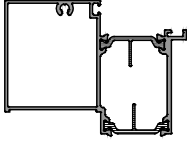

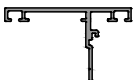
GİZLİ KANATLI PENCERE ve KAPI SİSTEMİ
CONCEALED SASH WINDOW and DOOR
SYSTEM









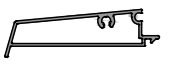
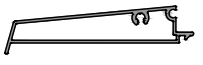

ALUMİNYUM PROFİLLER
ALUMINIUM PROFILES



PROFİL ŞEKLİ PROFILE SECTION	PROFİL ADI PROFILE NO	KALIP KODU DIE NO	PROFİL TANIMI PROFILE DESCRIPTION	AĞIRLIK WEIGHT
	P 2600		YAN KASA PROFİLİ Side Frame Profile	1,610kg/mt
	P 2601	19910 + 19916	YAN KASA PROFİLİ Side Frame Profile	1,750kg/mt
	P 2602		YAN KASA PROFİLİ Side Frame Profile	1,890kg/mt
	P 2603		YAN KASA PROFİLİ Side Frame Profile	2,115kg/mt
	P 2604		YAN KASA PROFİLİ Side Frame Profile	2,255kg/mt
	P 2605		YAN KASA PROFİLİ Side Frame Profile	2,395kg/mt
	P 2606		ÜST KASA PROFİLİ Top Frame Profile	1,760kg/mt
	P 2607	19911 + 19915	ÜST KASA PROFİLİ Top Frame Profile	1,900kg/mt
	P 2608		ÜST KASA PROFİLİ Top Frame Profile	2,105kg/mt
	P 2609		ÜST KASA PROFİLİ Top Frame Profile	2,325kg/mt

PROFİL ŞEKLİ PROFILE SECTION	PROFİL ADI PROFILE NO	KALIP KODU DIE NO	PROFİL TANIMI PROFILE DESCRIPTION	AĞIRLIK WEIGHT
	P 2610		ÜST KASA PROFİLİ Top Frame Profile	2,530kg/mt
	P 2611		ÜST KASA PROFİLİ Top Frame Profile	2,670kg/mt
	P 2612	19913 + 19915	ALT KASA PROFİLİ Bottom Frame Profile	1,925kg/mt
	P 2613		ALT KASA PROFİLİ Bottom Frame Profile	2,095kg/mt
	P 2614		KASA PROFİLİ Frame Profile	1,390kg/mt
	P 2645		YENİLEME KASA PROFİLİ Renevation Frame Profile	1,540kg/mt
	P 2615		ORTA KAYIT PROFİLİ Mullion Profile	1,440kg/mt
	P 2588		YENİLEME KASA KAPAK PROFİLİ renovation cap profile for frame	0,300kg/mt
	P 2616	19912 + 600 515	GİZLİ KANAT PROFİLİ Hidden Sash Profile	1,450kg/mt
	P 2617	19914 + 600 515	GİZLİ KANAT PROFİLİ Hidden Sash Profile	1,150kg/mt

PROFİL ŞEKLİ PROFILE SECTION	PROFİL ADI PROFILE NO	KALIP KODU DIE NO	PROFİL TANIMI PROFILE DESCRIPTION	AĞIRLIK WEIGHT
	P 2618		KAPI KANAT PROFİLİ Door Sash Profile	1,945kg/mt
	P 2619		KAPI KANAT PROFİLİ Door Sash Profile	2,200kg/mt
	P 2620		KASA EK PROFİLİ Elargisseur Profile	1,280kg/mt
	P 2621		KASA EK PROFİLİ Elargisseur Profile	1,785kg/mt
	P 2622		KASA EK PROFİLİ Elargisseur Profile	2,545kg/mt
	P 2623		KANAT EK PROFİLİ Additional Sash Profile	1,520kg/mt
	P 2624		DIŞ KAPAK PROFİLİ External Cap Profile	0,705kg/mt
	P 2625		ADAPTOR PROFİLİ Adepter Profile	0,440kg/mt
	P 2626	19917	DIŞ KAPAK PROFİLİ External Cap Profile	0,560kg/mt

PROFİL ŞEKLİ PROFILE SECTION	PROFİL ADI PROFILE NO	KALIP KODU DIE NO	PROFİL TANIMI PROFILE DESCRIPTION	AĞIRLIK WEIGHT
	P 2627		EŞİK PROFİLİ Threshold Profile	0,910kg/mt
	P 2628		PERVAZ PROFİLİ Tape Isolation Profile	0,325kg/mt
	P 2629		PERVAZ PROFİLİ Tape Isolation Profile	0,395kg/mt
	P 2630		PERVAZ PROFİLİ Tape Isolation Profile	0,465kg/mt
	P 2631		PERVAZ PROFİLİ Tape Isolation Profile	0,535kg/mt
	P 2632		PERVAZ PROFİLİ Tape Isolation Profile	0,605kg/mt
	P 2633		PERVAZ PROFİLİ Aile De Recouvrement	0,170kg/mt
	P 2634		PERVAZ PROFİLİ Aile De Recouvrement	0,240kg/mt
	P 2635		DENİZLİK PROFİLİ Piece D'appui Profile	0,660kg/mt
	P 2636		DENİZLİK PROFİLİ Piece D'appui Profile	0,765kg/mt

PROFİL ŞEKLİ PROFILE SECTION	PROFİL ADI PROFILE NO	KALIP KODU DIE NO	PROFİL TANIMI PROFILE DESCRIPTION	AĞIRLIK WEIGHT
	P 2637		ADAPTOR PROFİLİ Adepter Profile	0,330kg/mt
	P 2638		KAPI ÇITA PROFİL Door Slat Profile	0,225kg/mt
	P 2639		12,5mm CAM ÇITASI 12,5mm glazing bead profile	0,410kg/mt
	P 2640		18,5mm CAM ÇITASI 18,5mm glazing bead profile	0,445kg/mt
	P 2641		25mm CAM ÇITASI 25mm glazing bead profile	0,490kg/mt
	P 2642		30,5mm CAM ÇITASI 30,5mm glazing bead profile	0,515kg/mt
	P 2643		36,5mm CAM ÇITASI 36,5mm glazing bead profile	0,540kg/mt
	P 2644		KAPI ÇITA PROFİL Door Slat Profile	0,370kg/mt
	P 2180		12,5mm CAM ÇITASI 12,5mm glazing bead profile	0,240kg/mt
	P 2181	18279	18,5mm CAM ÇITASI 18,5mm glazing bead profile	0,285kg/mt

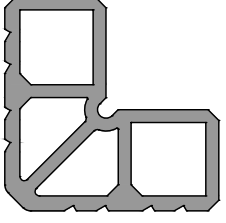
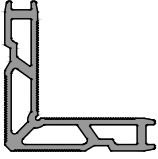
PROFİL ŞEKLİ PROFILE SECTION	PROFİL ADI PROFILE NO	KALIP KODU DIE NO	PROFİL TANIMI PROFILE DESCRIPTION	AĞIRLIK WEIGHT
	P 2182	18096	25mm CAM ÇITASI 25mm glazing bead profile	0,295kg/mt
	P 2183		30,5mm CAM ÇITASI 30,5mm glazing bead profile	0,320kg/mt
	P 2184		36,5mm CAM ÇITASI 36,5mm glazing bead profile	0,340kg/mt
	P 1850	17089	GİZLİ KANAT CAM ÇITASI glazing bead profile for hidden sash	0,100kg/mt
	P 1020	12769	TİJ PROFİLİ (eloxal) rod profile (anodised)	0,105kg/mt
	P 1187	5539	KÖŞE TAKOZ PROFİLİ Corner Cleat Profile	8,305kg/mt
	P 1701	9084	KÖŞE TAKOZ PROFİLİ Corner Cleat Profile	2,360kg/mt
	P 2093	9854	KÖŞE TAKOZ PROFİLİ Corner Cleat Profile	4,005kg/mt
	P 2158	5541	KÖŞE TAKOZ PROFİLİ Corner Cleat Profile	2,550kg/mt

ALFA

GİZLİ KANATLI PENCERE ve KAPI SİSTEMİ
CONCEALED SASH WINDOW and DOOR
SYSTEM

CAM MONTAJ TALİMATI
GLAZING ASSEMBLY

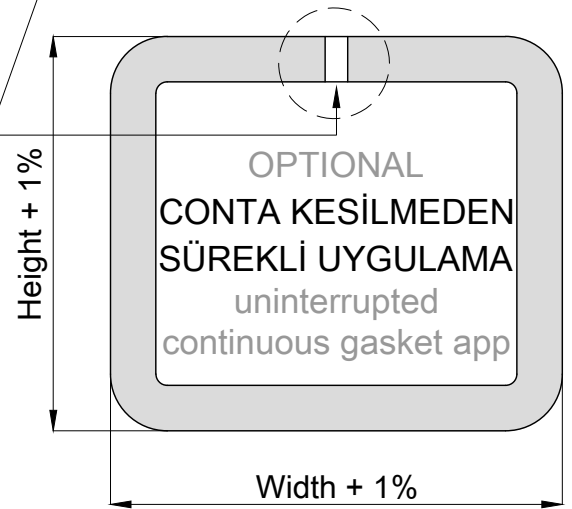
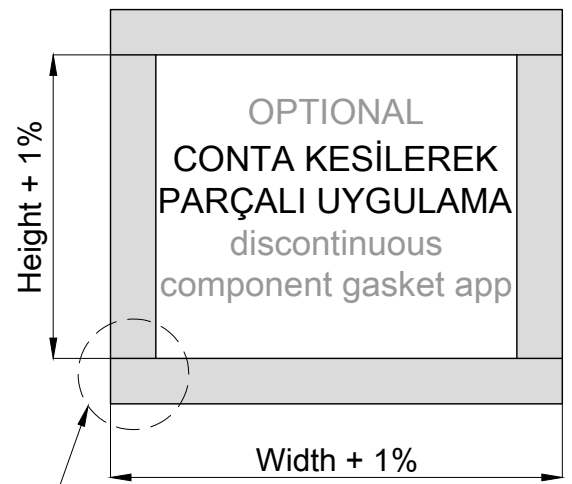
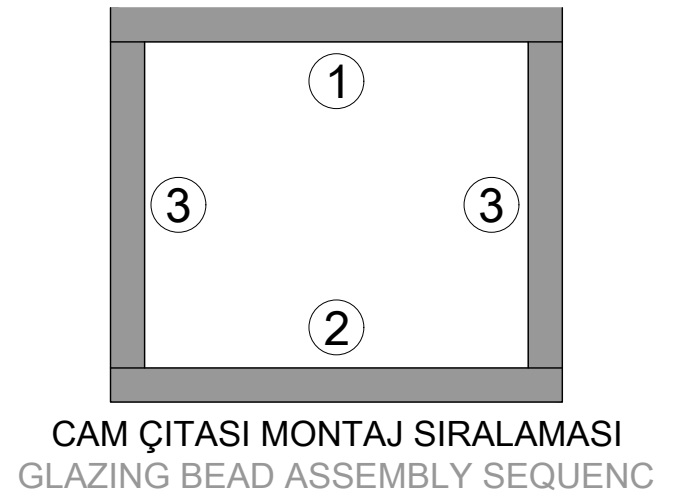
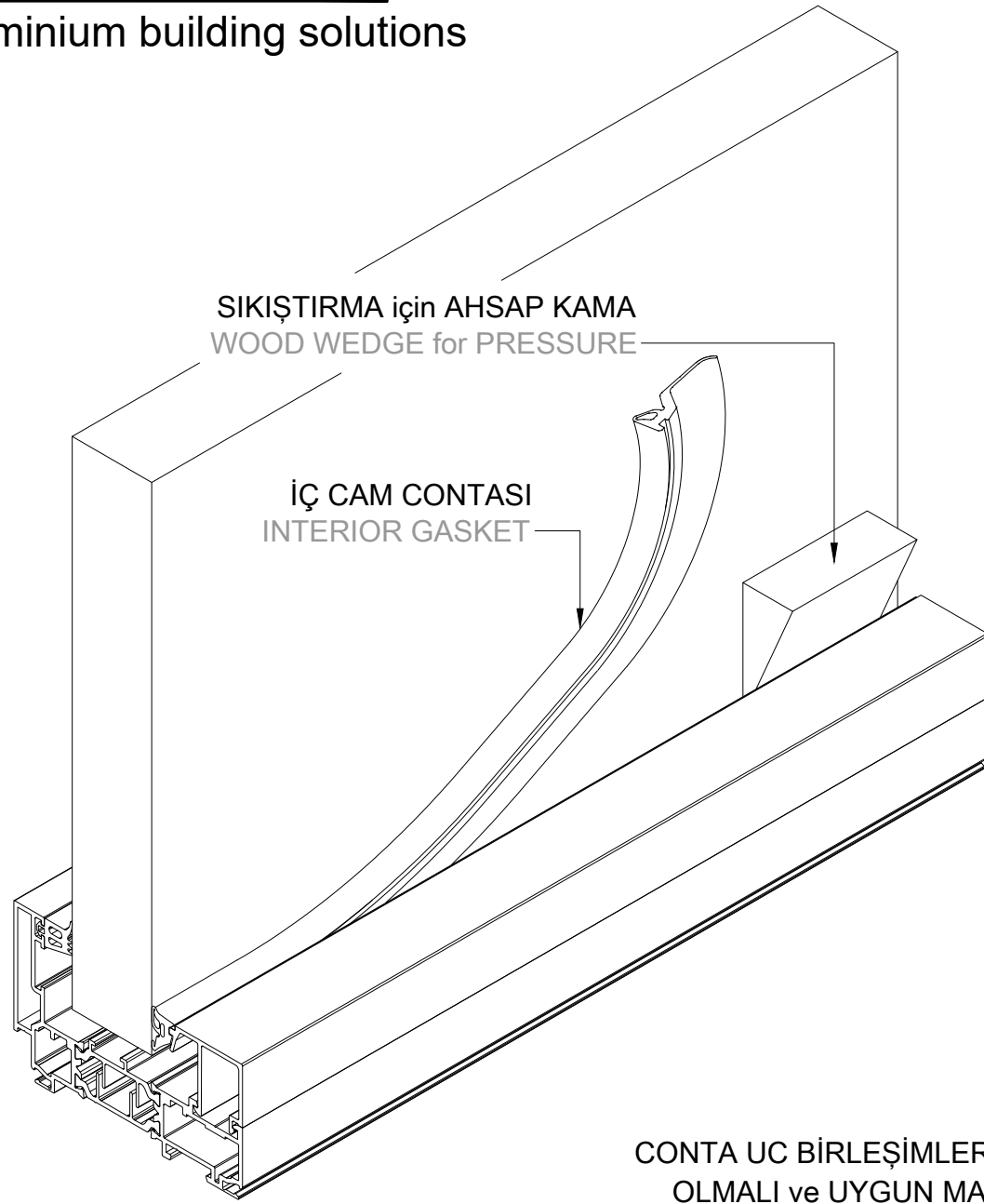

CONTA UC BİRLEŞİMLERİ ÜSTTE
OLMALI ve UYGUN MASTİK İLE
YAPIŞTIRILMALI
GASKET JOINT ON THE TOP,
BOND WITH EPDM GLUE.

1 CAM TAKOZU

Cam takozlari yerlesimi altta bulunan sematik çizimde gösterilmiştir.
takozlari kenara mesafeleri kanat ölçüsünün 5/1 i yada 10/1 i kadar olmalıdır.

GLASS CLEATS
The assembly of glass reinforcement pieces has been showed at the top schemetically. The gap distance to the corner should be, the 5/1 or 10/1 of the sash size.

2 MESAFE AYARLAMA TAKOZU

Mesafe ayar takozlari camin alüminyum çerçeve içinde doğru pozisyonda stabil olarak durmasını sağlar.
cam ile profil arasına takozlari zorlamadan yerleştiriniz.



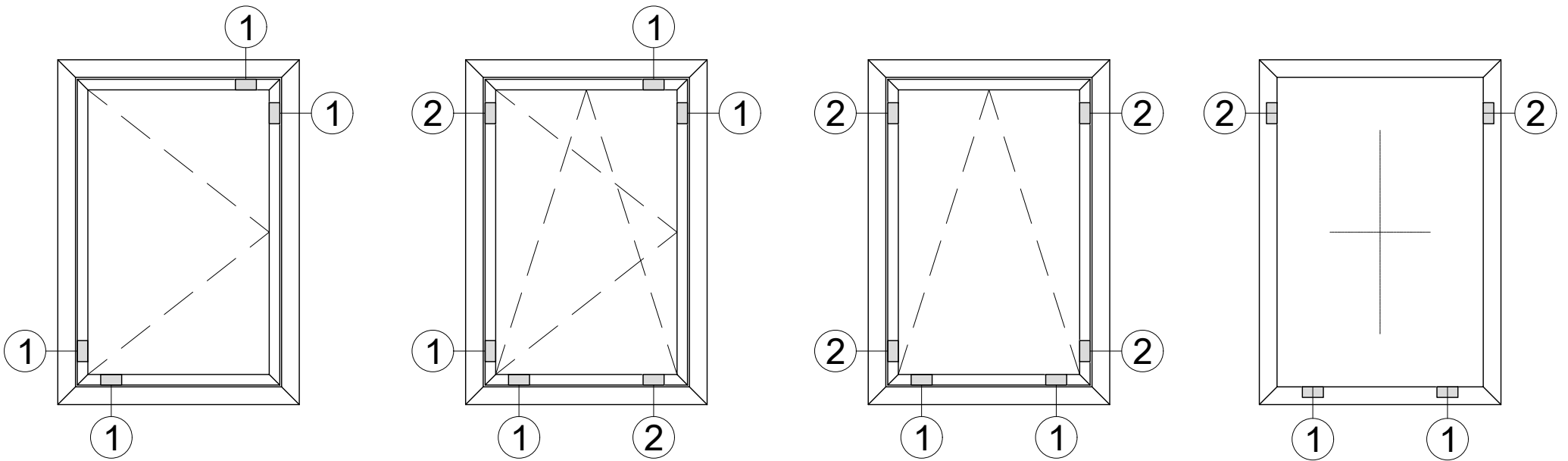







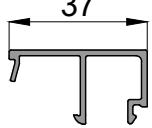



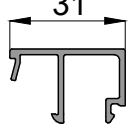



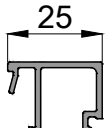

DISTANCE ADJUSTMENT PIECE
Distance adjustment pieces stabilize the glass in the frame at the true position. Put the distance adjustment piece between glass and profile without using force.

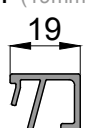

AKSESUAR ve DONANIM MONTAJINDAN ÖNCE,
CAM ve TAKOZLAMA İŞLEMİ YAPILMALIDIR.
THE PANE MUST BE SHIMMED IN THE SASH SO THAT THE SASH
OPERATES WITHOUT ADJUSTMENT OF THE HARDWARE.

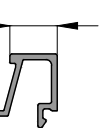
1 TAŞIYICI TAKOZ
GLASS CLEAT

2 AYAR TAKOZU
ADJUSTMENT PIECE

CAM KALINLIĞI glass thickness	ÇITA glazing bead		CAM CONTASI glazing gasket
	profil section	kod code	standart conta without fin gasket
9mm	P 2184 (37mm) 37		 800 278 (10mm)
11mm			 800 277 (8mm)
13mm			 800 271 (6mm)
15mm	P 2183 (31mm) 31		 800 278 (10mm)
17mm			 800 277 (8mm)
19mm			 800 271 (6mm)
21mm	P 2182 (25mm) 25		 800 278 (10mm)
23mm			 800 277 (8mm)
25mm			 800 271 (6mm)
27mm	P 2181 (19mm) 19		 800 278 (10mm)
29mm			 800 277 (8mm)
31mm			 800 271 (6mm)
33mm	P 2180 (13mm) 13		 800 278 (10mm)
35mm			 800 277 (8mm)
37mm			 800 271 (6mm)

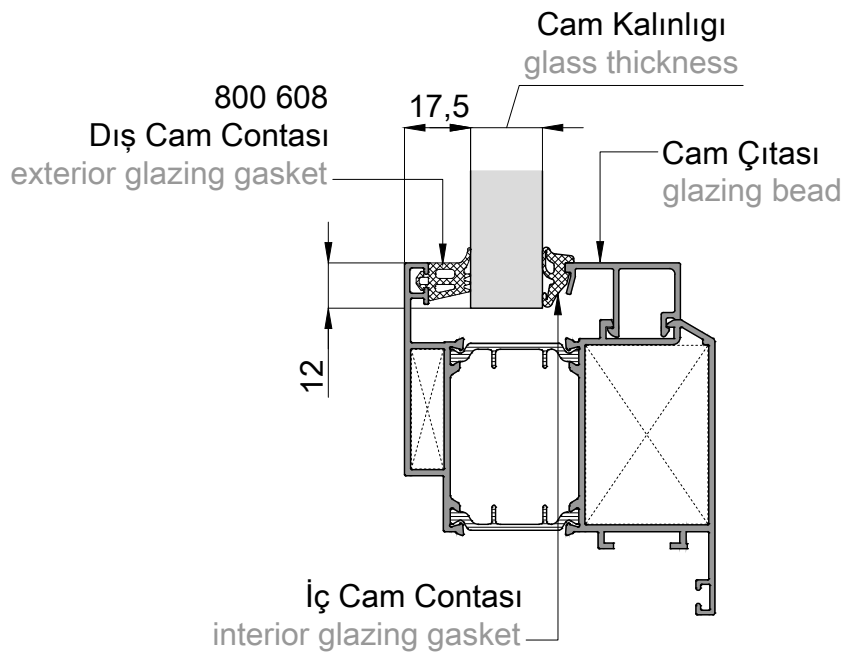

Yanda tablodaki veriler teoriktir.
Lütfen cam ve conta toleranslarını dikkate alınız.
selection tables promise a first planning.
Please keep the glass and gasket tolerances in mind.

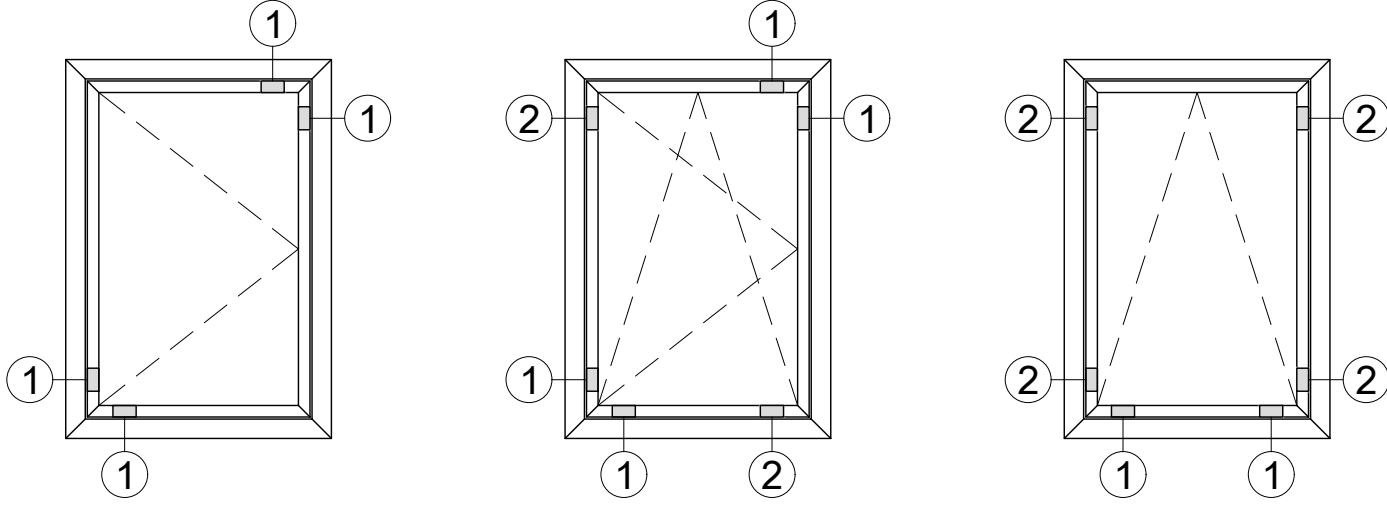

- ① **CAM TAKOZU**
Cam takozlari yerlesimi altta bulunan sematik çizimde gösterilmiştir. takozların kenara mesafeleri kanat ölçüsünün 5/1 i yada 10/1 i kadar olmalıdır.
GLASS CLEATS
The assembly of glass reinforcement pieces has been showed at the top schemetically. The gap distance to the corner should be, the 5/1 or 10/1 of the sash size.
- ② **MESAFE AYARLAMA TAKOZU**
Mesafe ayar takozlari camin alüminyum çerçeve içinde doğru pozisyonda stabil olarak durmasını sağlar. cam ile profil arasına takozlari zorlamadan yerleştiriniz.
DISTANCE ADJUSTMENT PIECE
Distance adjustment pieces stabilize the glass in the frame at the true position. Put the distance adjustment piece between glass and profile without using force.

AKSESUAR ve DONANIM MONTAJINDAN ÖNCE,
CAM ve TAKOZLAMA İŞLEMİ YAPILMALIDIR.
THE PANE MUST BE SHIMMED IN THE SASH
SO THAT THE SASH
OPERATES WITHOUT ADJUSTMENT OF
THE HARDWARE.

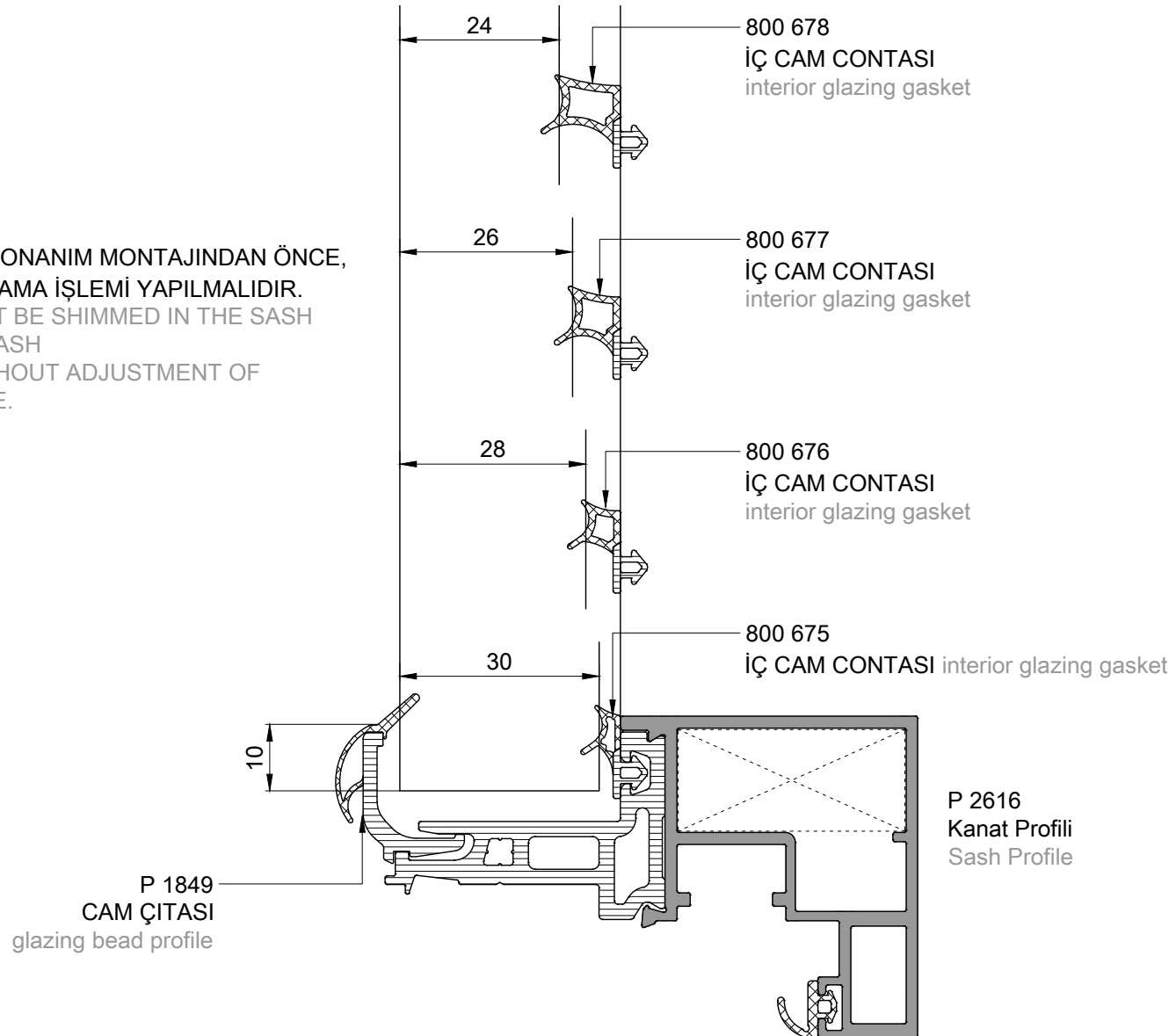

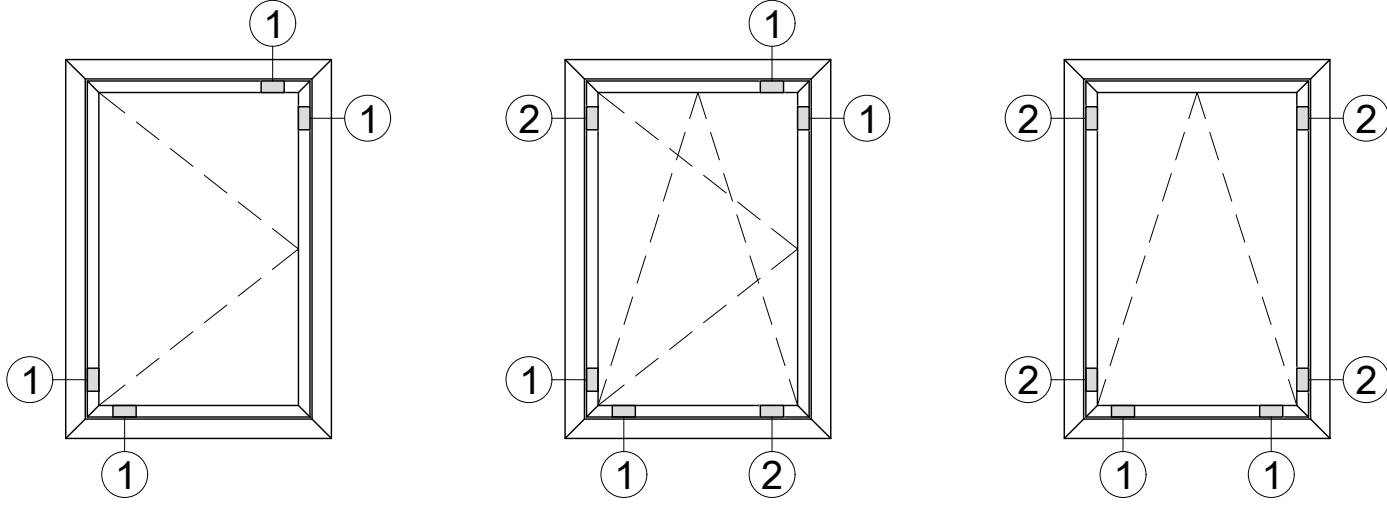

- ① **CAM TAKOZU**
Cam takozlari yerlesimi altta bulunan sematik çizimde gösterilmiştir. takozların kenara mesafeleri kanat ölçüsünün 5/1 i yada 10/1 i kadar olmalıdır.
GLASS CLEATS
The assembly of glass reinforcement pieces has been showed at the top schemetically. The gap distance to the corner should be, the 5/1 or 10/1 of the sash size.
- ② **MESAFE AYARLAMA TAKOZU**
Mesafe ayar takozlari camin alüminyum çerçeve içinde doğru pozisyonda stabil olarak durmasını sağlar. cam ile profil arasına takozlari zorlamadan yerleştiriniz.
DISTANCE ADJUSTMENT PIECE
Distance adjustment pieces stabilize the glass in the frame at the true position. Put the distance adjustment piece between glass and profile without using force.

AKSESUAR ve DONANIM MONTAJINDAN ÖNCE,
CAM ve TAKOZLAMA İŞLEMİ YAPILMALIDIR.
THE PANE MUST BE SHIMMED IN THE SASH
SO THAT THE SASH
OPERATES WITHOUT ADJUSTMENT OF
THE HARDWARE.

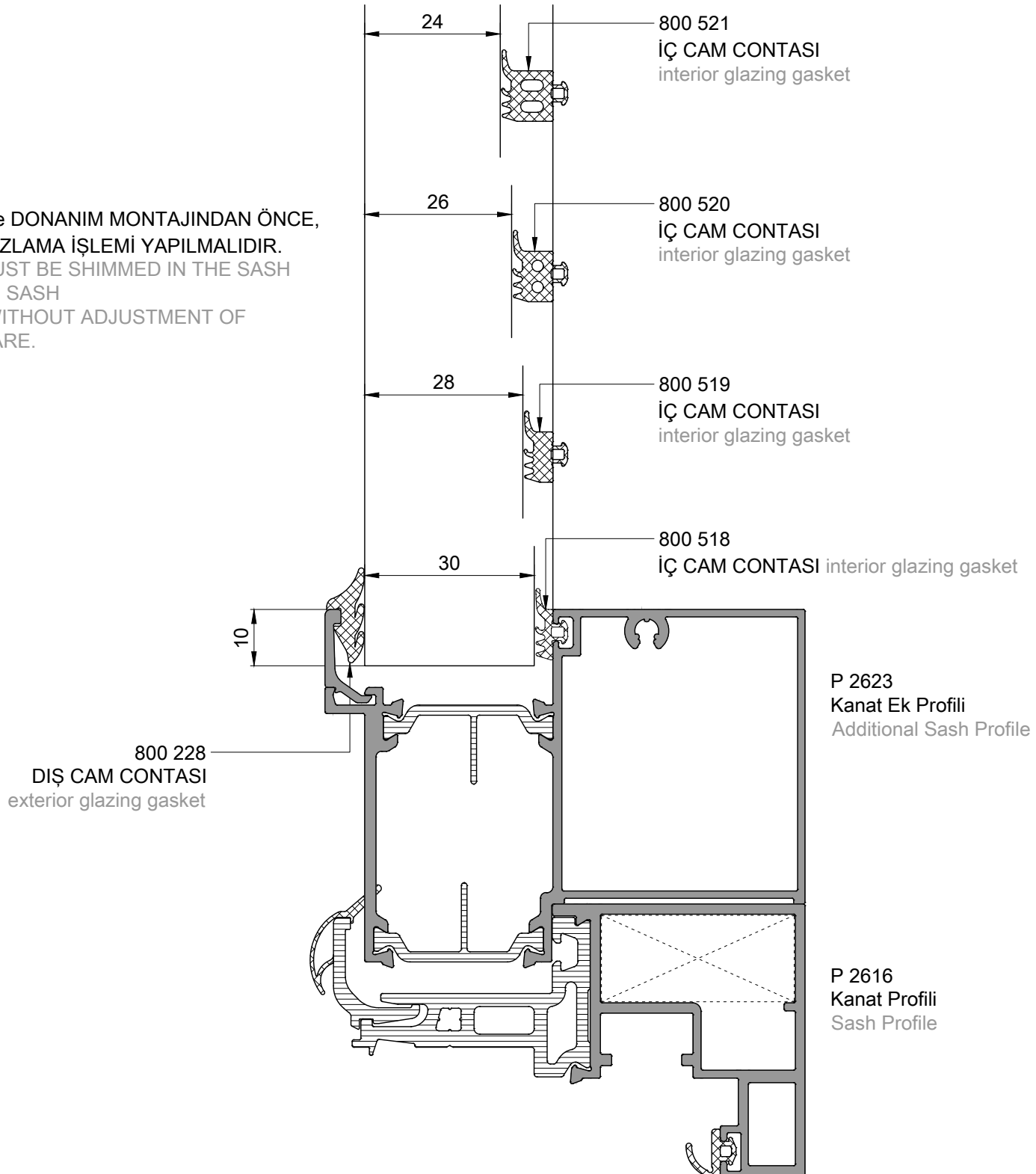

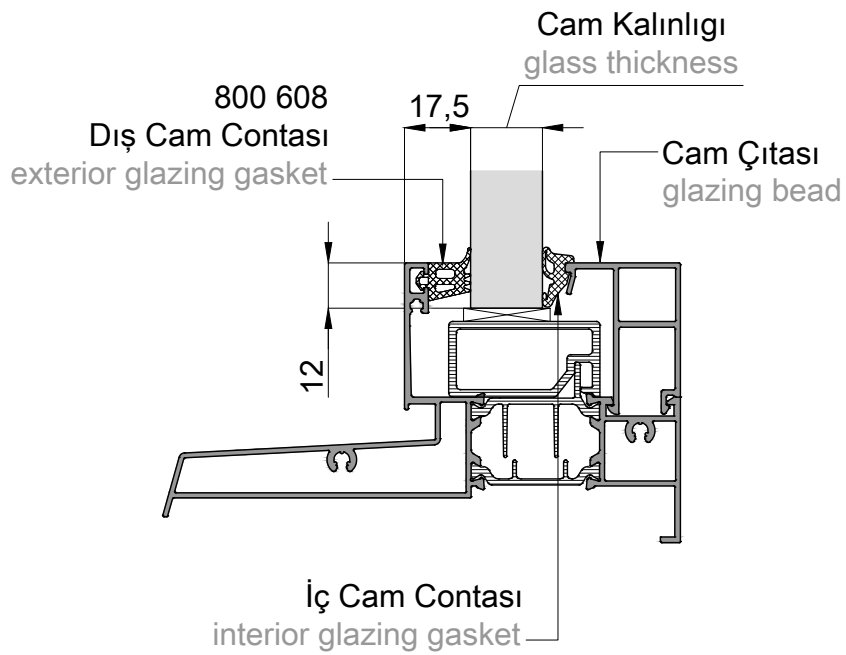











Yanda tablodaki veriler teoriktir.
Lütfen cam ve conta toleranslarını dikkate alınız.
selection tables promise a first planning.
Please keep the glass and gasket tolerances in mind.





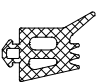

CAM KALINLIĞI glass thickness	ÇITA glazing bead		CAM CONTASI glazing gasket
	profil section	kod code	standart conta without fin gasket
9mm	P 2643 (37mm) 37		800 278 (10mm)
11mm			800 277 (8mm)
13mm			800 271 (6mm)
15mm	P 2642 (31mm) 31		800 278 (10mm)
17mm			800 277 (8mm)
19mm			800 271 (6mm)
21mm	P 2641 (25mm) 25		800 278 (10mm)
23mm			800 277 (8mm)
25mm			800 271 (6mm)
27mm	P 2640 (19mm) 19		800 278 (10mm)
29mm			800 277 (8mm)
31mm			800 271 (6mm)
33mm	P 2639 (13mm) 13		800 278 (10mm)
35mm			800 277 (8mm)
37mm			800 271 (6mm)

ALFA

GİZLİ KANATLI PENCERE ve KAPI SİSTEMİ CONCEALED SASH WINDOW and DOOR SYSTEM

CONTALAR
GASKETS

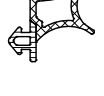
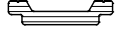
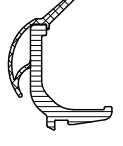
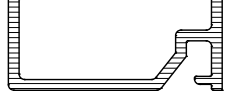

CONTA ŞEKLİ GASKET SECTION	CONTA KODU GASKET NO	MALZEME MATERIAL	CONTA TANIMI GASKET DESCRIPTION	PAKET PACKAGE
	800 228	EPDM	DIŞ CAM CONTASI exterior glazing gasket	185mt/pk 0,081kg/mt
	800 234	EPDM	Ø4mm YUVARLAK CONTA Ø4 oring gasket	500mt/pk 0,017kg/mt
	800 271	EPDM	İÇ CAM CONTASI interior glazing gasket	185mt/pk 0,081kg/mt
	800 277	EPDM	İÇ CAM CONTASI interior glazing gasket	165mt/pk 0,092kg/mt
	800 278	EPDM	İÇ CAM CONTASI interior glazing gasket	115mt/pk 0,130kg/mt
	800 298	EPDM	KAPATMA CONTASI closing gasket	185mt/pk 0,082kg/mt
	800 517	EPDM	DIŞ CAM CONTASI exterior glazing gasket	136mt/pk 0,110kg/mt
	800 518	EPDM	3mm İÇ CAM CONTASI 3mm interior glazing gasket	303mt/pk 0,033kg/mt
	800 519	EPDM	5mm İÇ CAM CONTASI 5mm interior glazing gasket	268mt/pk 0,056kg/mt
	800 520	EPDM	7mm İÇ CAM CONTASI 7mm interior glazing gasket	211mt/pk 0,071kg/mt



CONTA ŞEKLİ GASKET SECTION	CONTA KODU GASKET NO	MALZEME MATERIAL	CONTA TANIMI GASKET DESCRIPTION	PAKET PACKAGE
	800 521	EPDM	9mm İÇ CAM CONTASI 9mm interior glazing gasket	178mt/pk 0,084kg/mt
	800 648	EPDM	İÇ-DIŞ BİNİ CONTASI ext-int. overlap gasket	370mt/pk 0,035kg/mt
	800 649	EPDM	ALT BİNİ CONTASI bottom overlap gasket	430mt/pk 0,030kg/mt
	800 675	TPE	İÇ CAM CONTASI interior glazing gasket	295mt/pk 0,044kg/mt
	800 676	TPE	İÇ CAM CONTASI interior glazing gasket	240mt/pk 0,054kg/mt
	800 677	TPE	İÇ CAM CONTASI interior glazing gasket	200mt/pk 0,065kg/mt
	800 678	TPE	İÇ CAM CONTASI interior glazing gasket	175mt/pk 0,075kg/mt
	600 429	polyamide	TİJ PROFİLİ rod profile	6mt 25ad/pk. 0,070kg/mt
	600 491	PVC	DIŞ CAM CONTASI exterior glazing gasket	6mt 25ad/pk. 0,188kg/mt
	600 508	PVC	DIŞ TAŞIYICI PROFİL glass support profile	6mt 25ad/pk. 0,345kg/mt

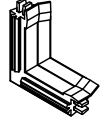

A L F A

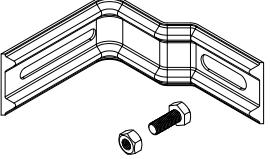
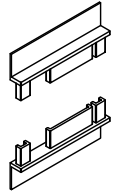
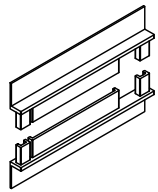
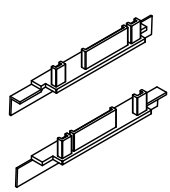
GİZLİ KANATLI PENCERE ve KAPI SİSTEMİ CONCEALED SASH WINDOW and DOOR SYSTEM

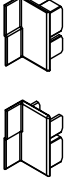
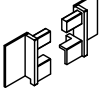
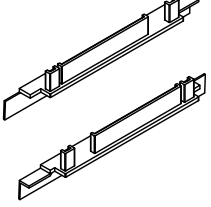
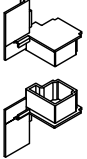
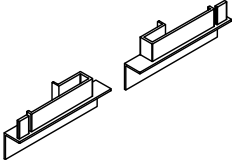
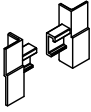
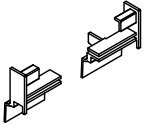
AKSESUARLAR ACCESSORIES

AKSESUAR ŐEKLİ ACCESSORIES SHAPE	AKSESUAR ACCESS. NO	AKSESUAR TANIMI ACCESSORIES DESCRIPTION	MİKTAR QUANTITY
	700 451	SU TAHLİYE KAPAGI weep hole cap	50 adet/pieces
	700 840	DIŐ CAM CONTASI KÖŐE VULKANİZE vulcanized corner for exterior glazing gasket	50 adet/pieces
	701 192	PERVAZ MONTAJ KLİPSİ injection clip for finishing profiles	100 adet/pieces
	701 241	MONTAJ ANKRAJİ installing bracket	20 adet/pieces
	701 260	ÇİFT KANAT PENCERE DAR DIŐ ADAPTOR PROFİLİ TAPASI double sash window door wide external adapter profile cap plug	20 çift/pair
	701 261	ÇİFT KANAT KAPI GENİŐ DIŐ ADAPTOR PROFİLİ TAPASI double sash door wide external adapter profile cap plug	20 çift/pair
	701 262	EŐİKLİ KAPI DIŐ ADAPTOR KAPAGI cap plug for door with threshold	20 çift/pair

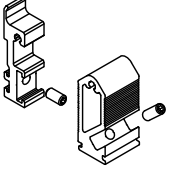
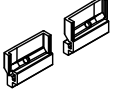
AKSESUAR ŞEKLİ ACCESSORIES SHAPE	AKSESUAR ACCESS. NO	AKSESUAR TANIMI ACCESSORIES DESCRIPTION	MİKTAR QUANTITY
	701 263	İNCE KANAT İÇ KAPAK interior cap plug for slim sash	20 çift/pair
	701 264	KAPI ALTI CAM ÇITA KAPAGI door bottom glazing bead end cap plug	20 çift/pair
	701 265	ÇİFT KANAT KAPI GENİŞ DIŞ ADAPTOR PROFİLİ TAPASI double sash door wide external adepter profile cap plug	20 çift/pair
	701 266	GİZLİ KANATLI KAPI İÇİN KAPAK cap plug for hidden door sash	20 çift/pair
	701 267	ÇİFT KANAT KAPI DIŞ ADAPTOR PROFİLİ TAPASI double sash door external adepter profile cap plug	20 çift/pair
	701 268	KAPI KANATI İÇ KAPAK interior cap plug for door sash	20 çift/pair
	701 269	KAPI ALT DAMLALIK KAPAGI cap plug for door sash dropper	20 çift/pair
	701 270	KAPI ALT DAMLALIK KAPAGI cap plug for door sash dropper	20 çift/pair

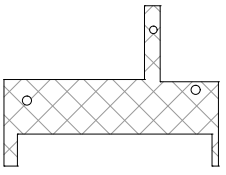
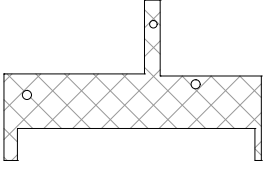
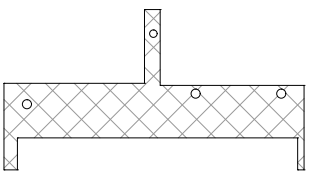
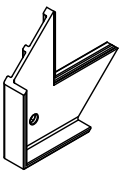
AKSESUAR ŐEKLİ ACCESSORIES SHAPE	AKSESUAR ACCESS. NO	AKSESUAR TANIMI ACCESSORIES DESCRIPTION	MİKTAR QUANTITY
	701 271	T BİRLEŐİM ANKRAJI T connection bracket	50 çift/pair
	701 272	T BİRLEŐİM SIZDIRMAZLIK KAPAGI tightness cap plug for T connection	20 çift/pair
	701 273	MONTAJ ANKRAJI installing bracket	20 adet/pieces
	701 274	100 ÜST KASA YALITIM BANTI 100 top frame insulation tape	50 adet/pieces
	701 275	120 ÜST KASA YALITIM BANTI 120 top frame insulation tape	50 adet/pieces
	701 276	140 ÜST KASA YALITIM BANTI 140 top frame insulation tape	50 adet/pieces
	701 277	KÖŐE ONBAŐI pvc corner angle	50 adet/pieces

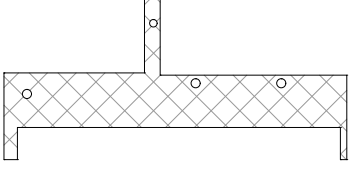
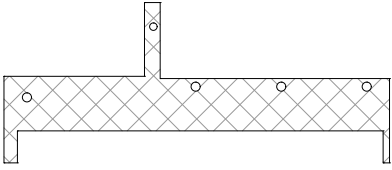
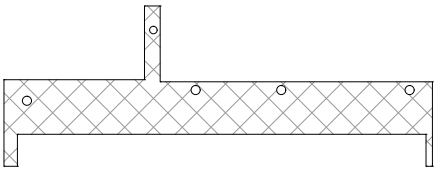
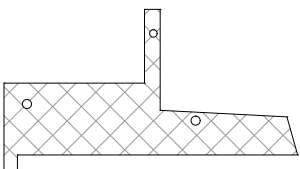
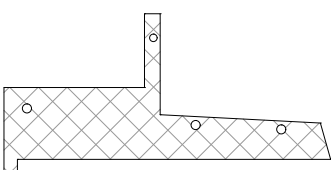
AKSESUAR ŐEKLİ ACCESSORIES SHAPE	AKSESUAR ACCESS. NO	AKSESUAR TANIMI ACCESSORIES DESCRIPTION	MİKTAR QUANTITY
	701 278	160 ÜST KASA YALITIM BANTI 160 top frame insulation tape	50 adet/pieces
	701 279	180 ÜST KASA YALITIM BANTI 180 top frame insulation tape	50 adet/pieces
	701 280	200 ÜST KASA YALITIM BANTI 200 top frame insulation tape	50 adet/pieces
	701 281	100-120-140 ALT KASA YALITIM BANTI 100-120-140 bottom frame insulation tape	50 adet/pieces
	701 282	160-180-200 ALT KASA YALITIM BANTI 160-180-200 bottom frame insulation tape	50 adet/pieces

ALFA

GİZLİ KANATLI PENCERE ve KAPI SİSTEMİ CONCEALED SASH WINDOW and DOOR SYSTEM

TAM ÖLÇEKLİ PROFİLLER
FULL SCALE PROFILES

P 2600
Yan Kasa Profili
Side Frame Profile
1,610kg/mt

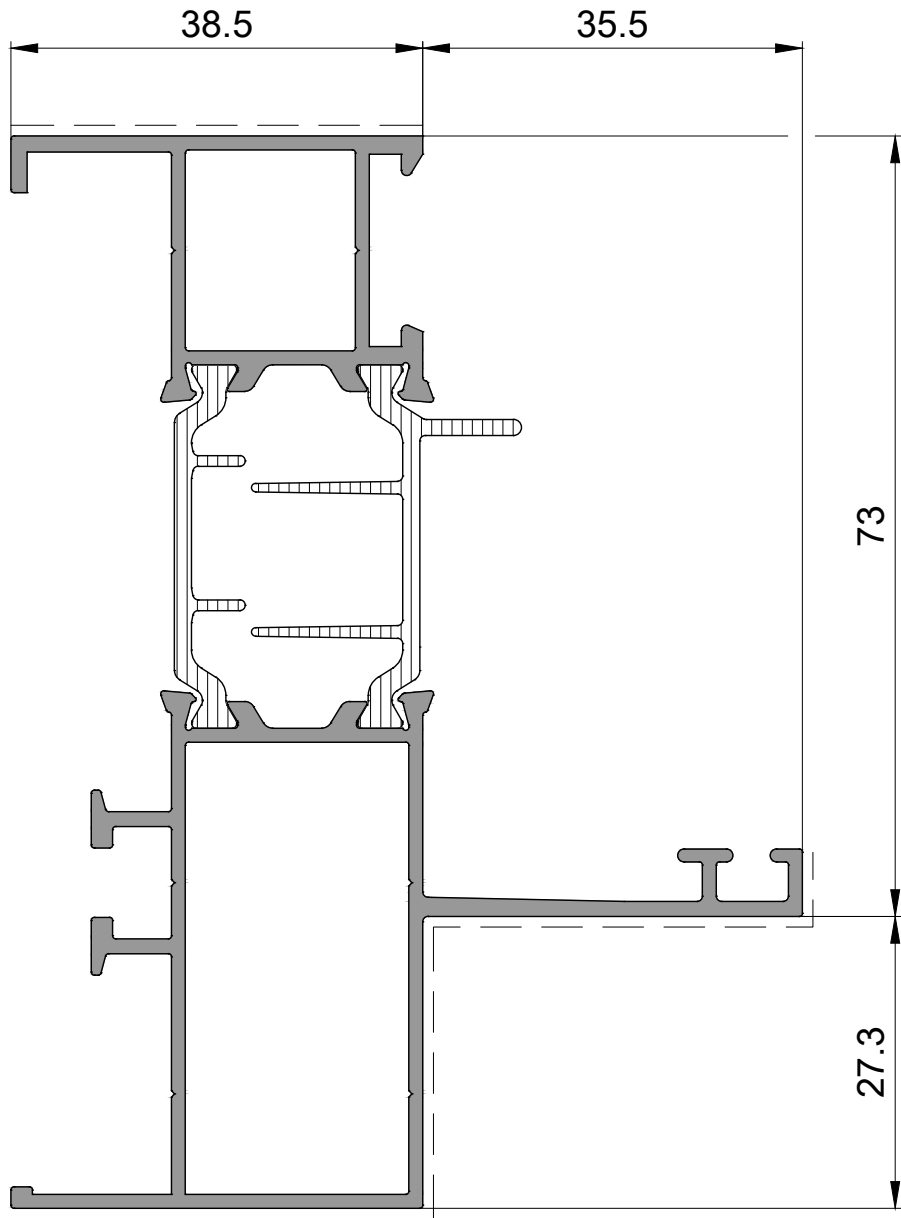

P 2601
Yan Kasa Profili
Side Frame Profile
1,750kg/mt

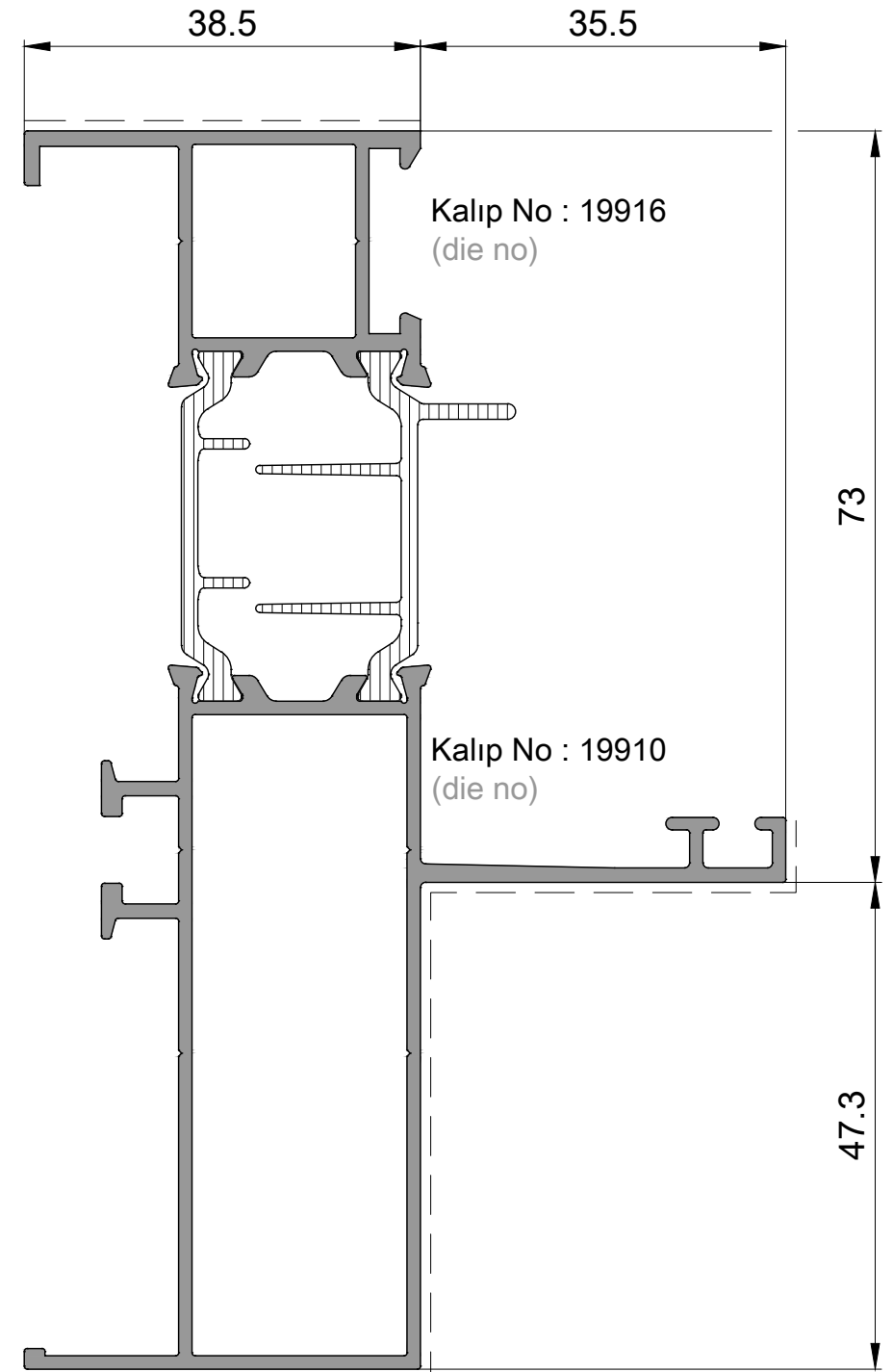

P 2602
Yan Kasa Profili
Side Frame Profile
1,890kg/mt

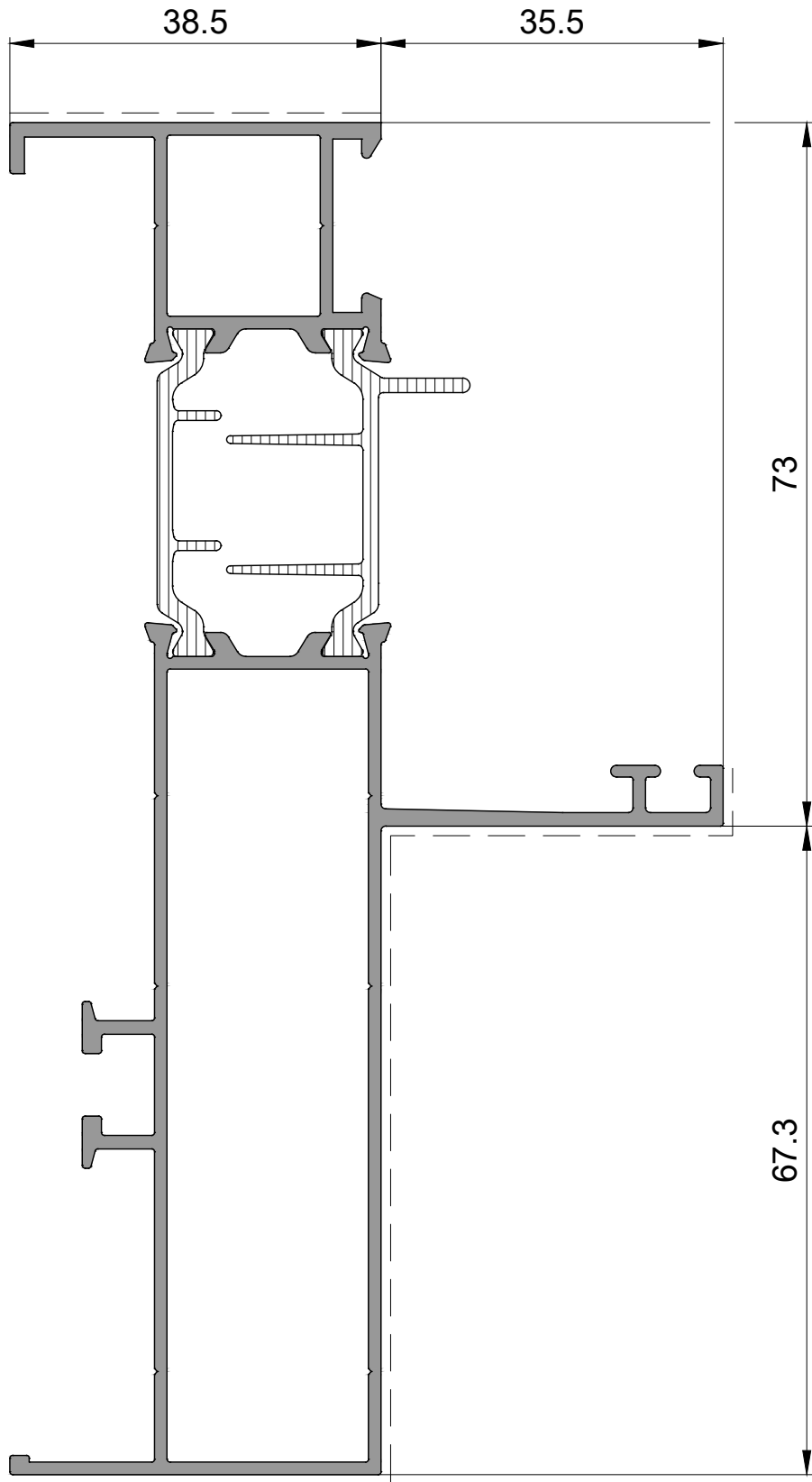

P 2603
Yan Kasa Profili
Side Frame Profile
2,115kg/mt

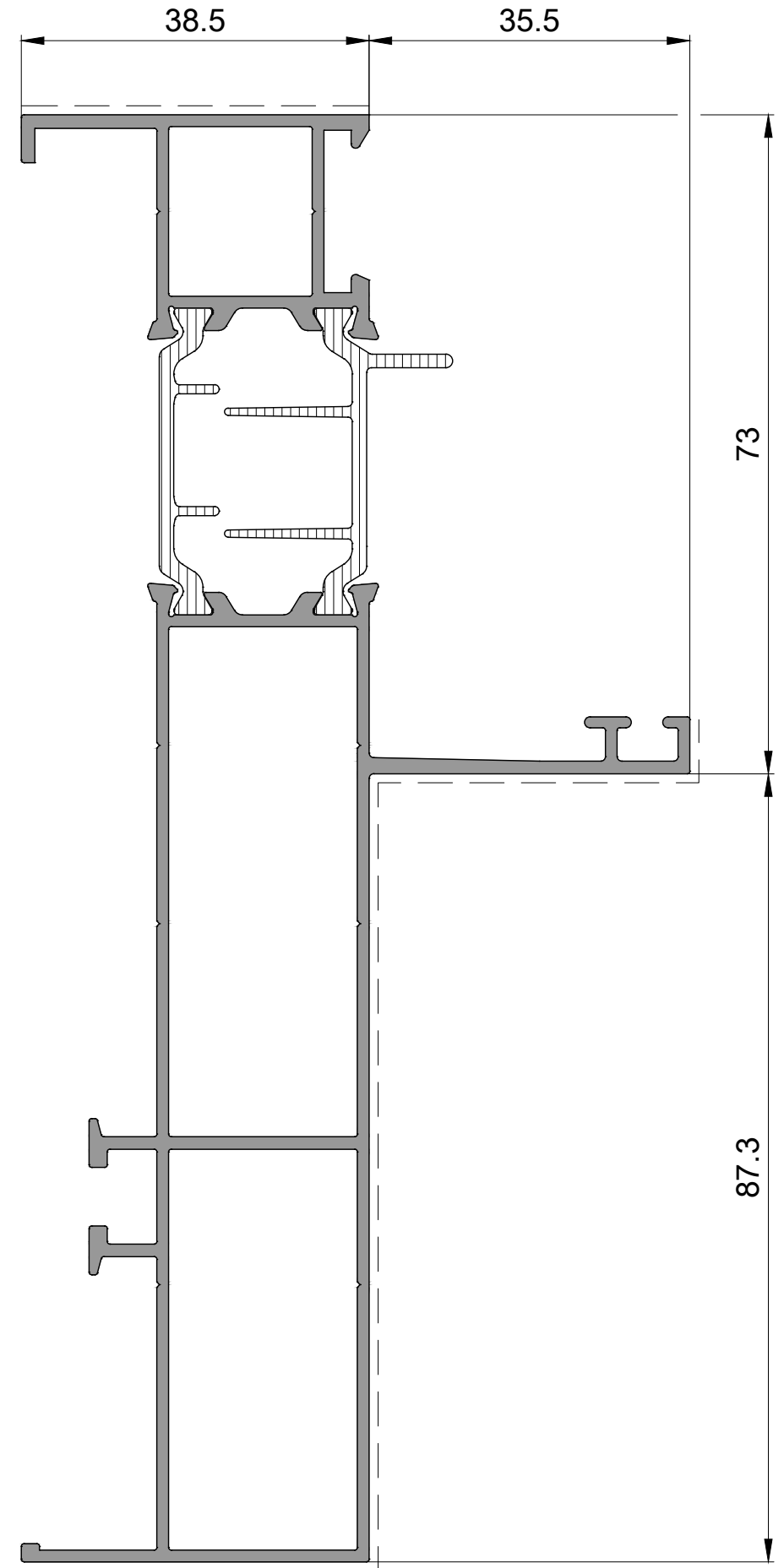

P 2604
Yan Kasa Profili
Side Frame Profile
2,255kg/mt

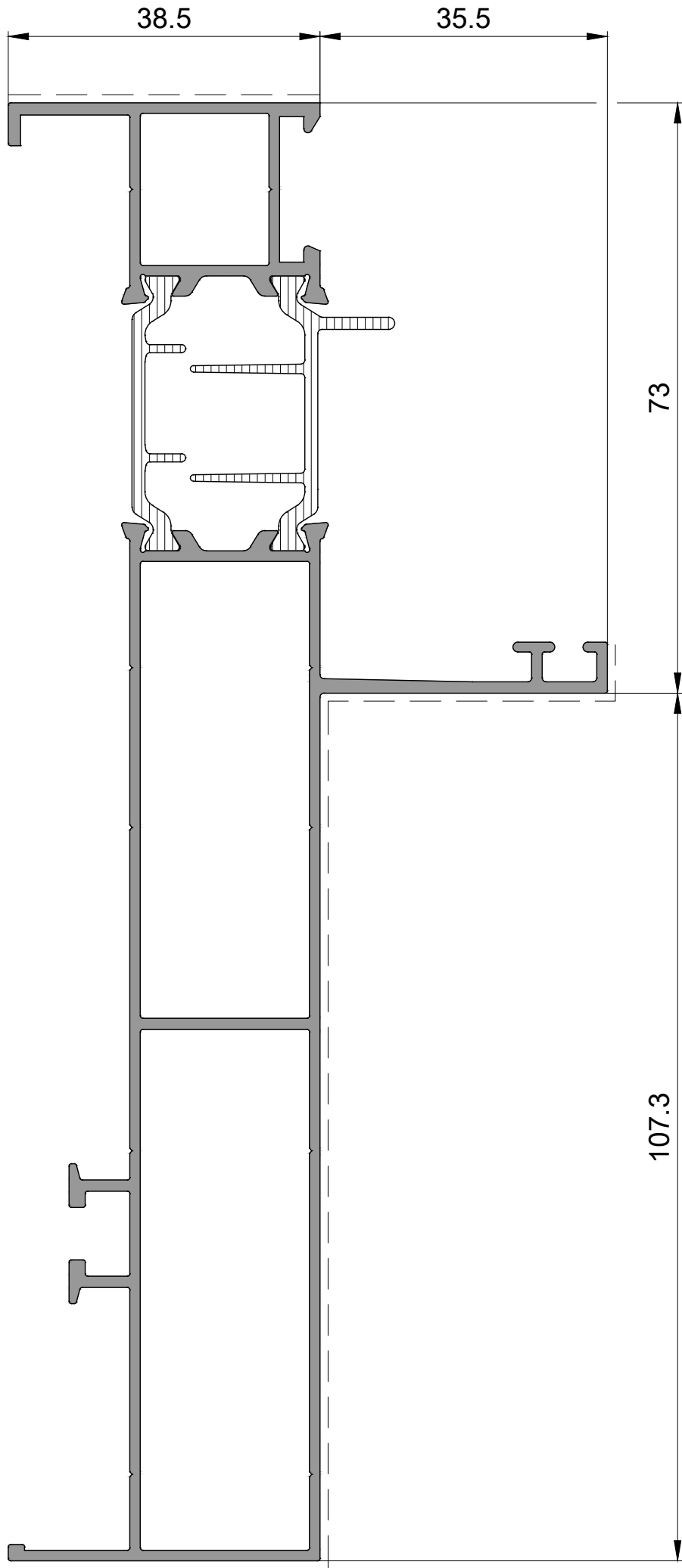

P 2605
Yan Kasa Profili
Side Frame Profile
2,395kg/mt

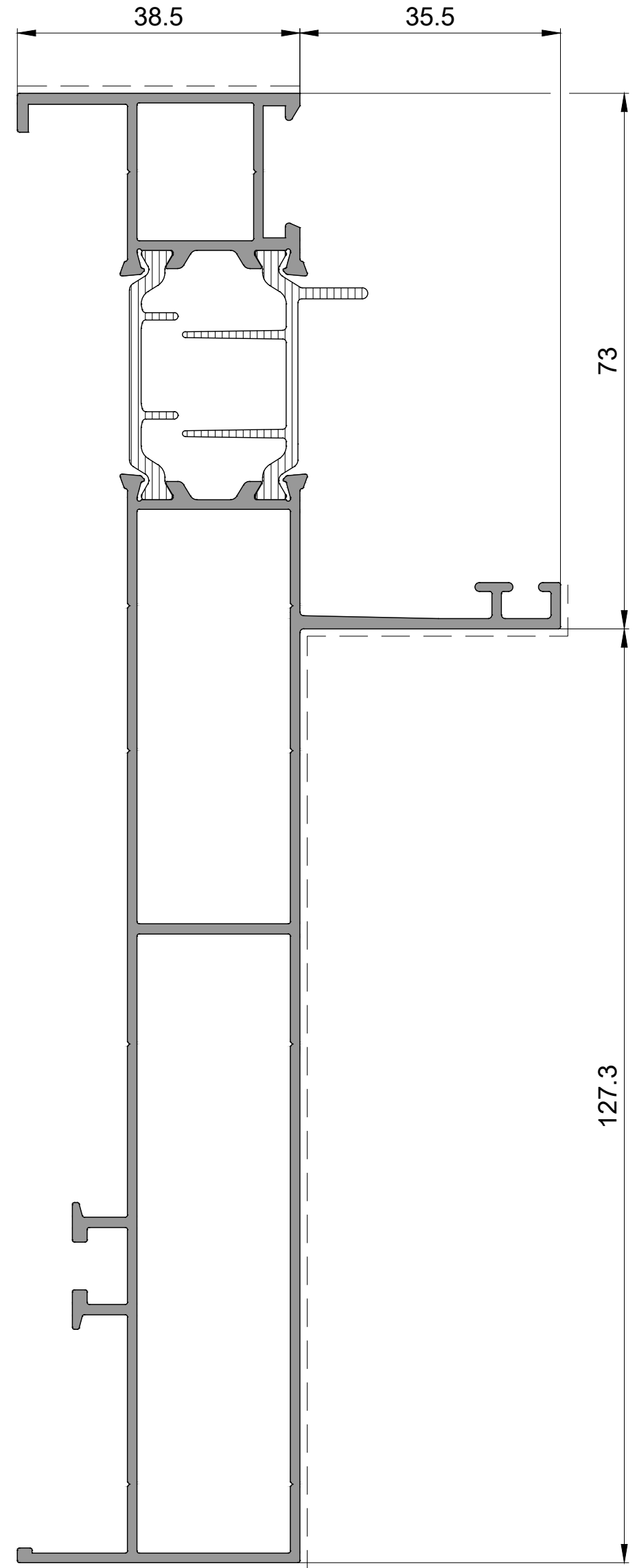

P 2606

Üst Kasa Profili
Top Frame Profile
1,760kg/mt

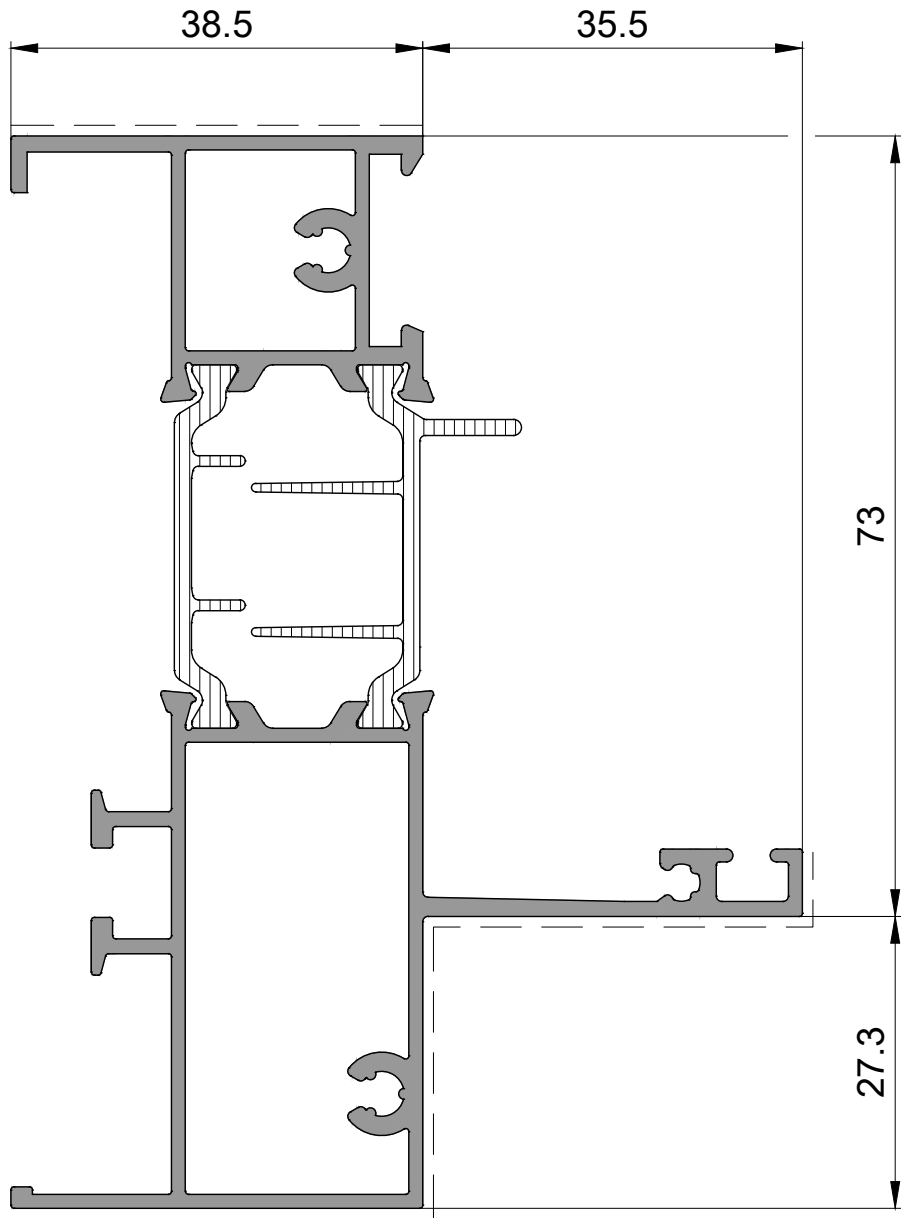

P 2607

Üst Kasa Profili
Top Frame Profile
1,900kg/mt

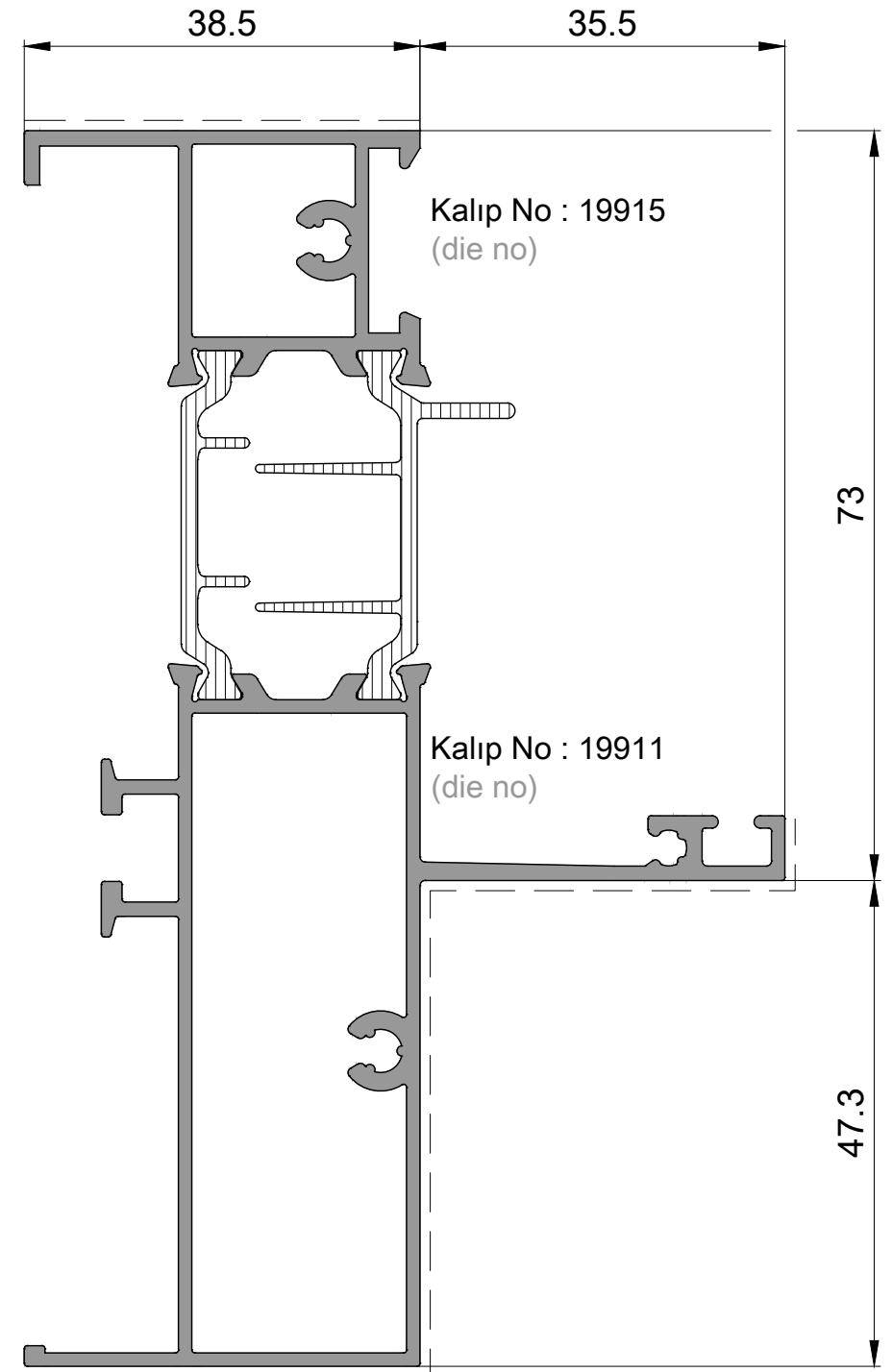

P 2608

Üst Kasa Profili
Top Frame Profile
2,105kg/mt

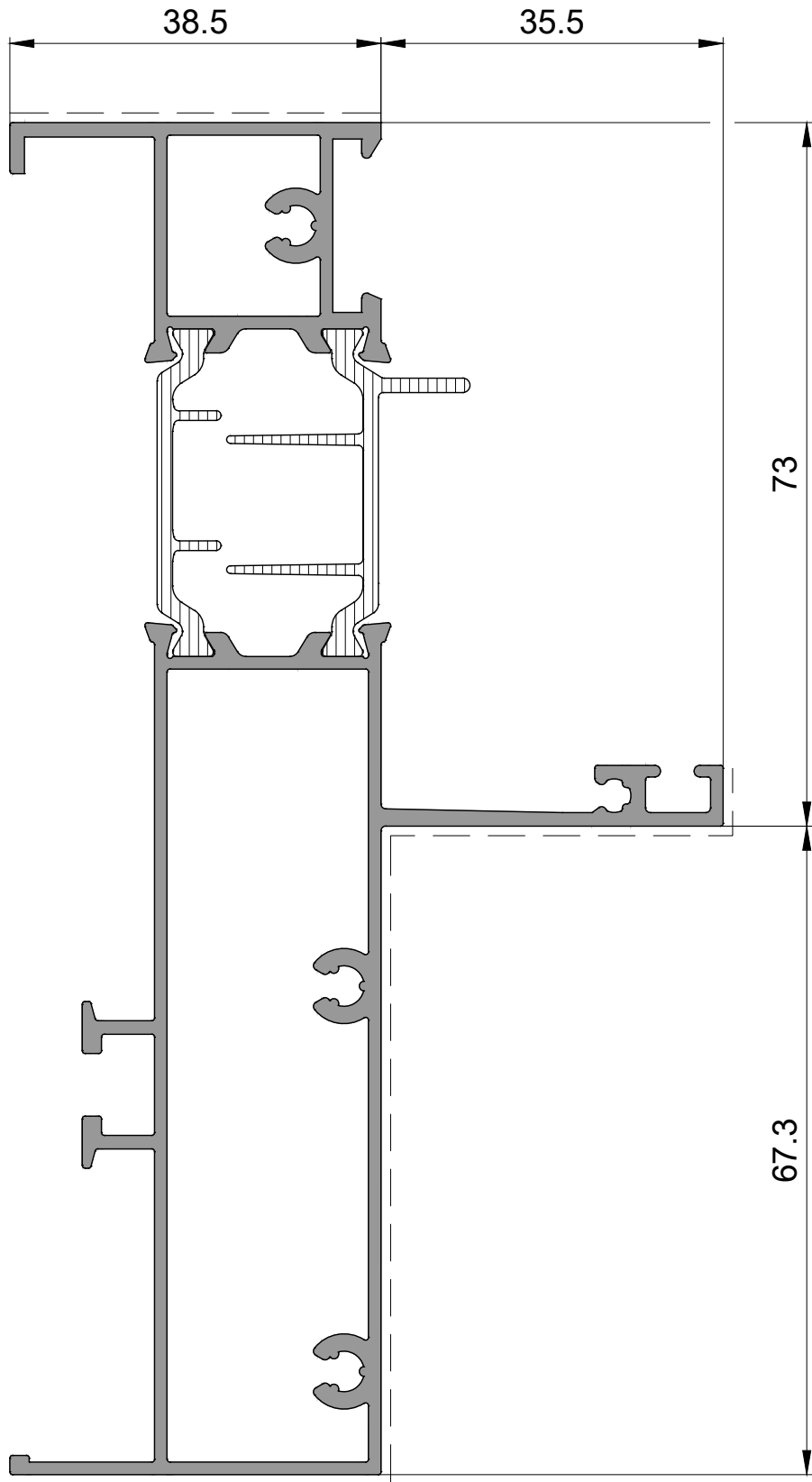

P 2609

Üst Kasa Profili
Top Frame Profile
2,325kg/mt

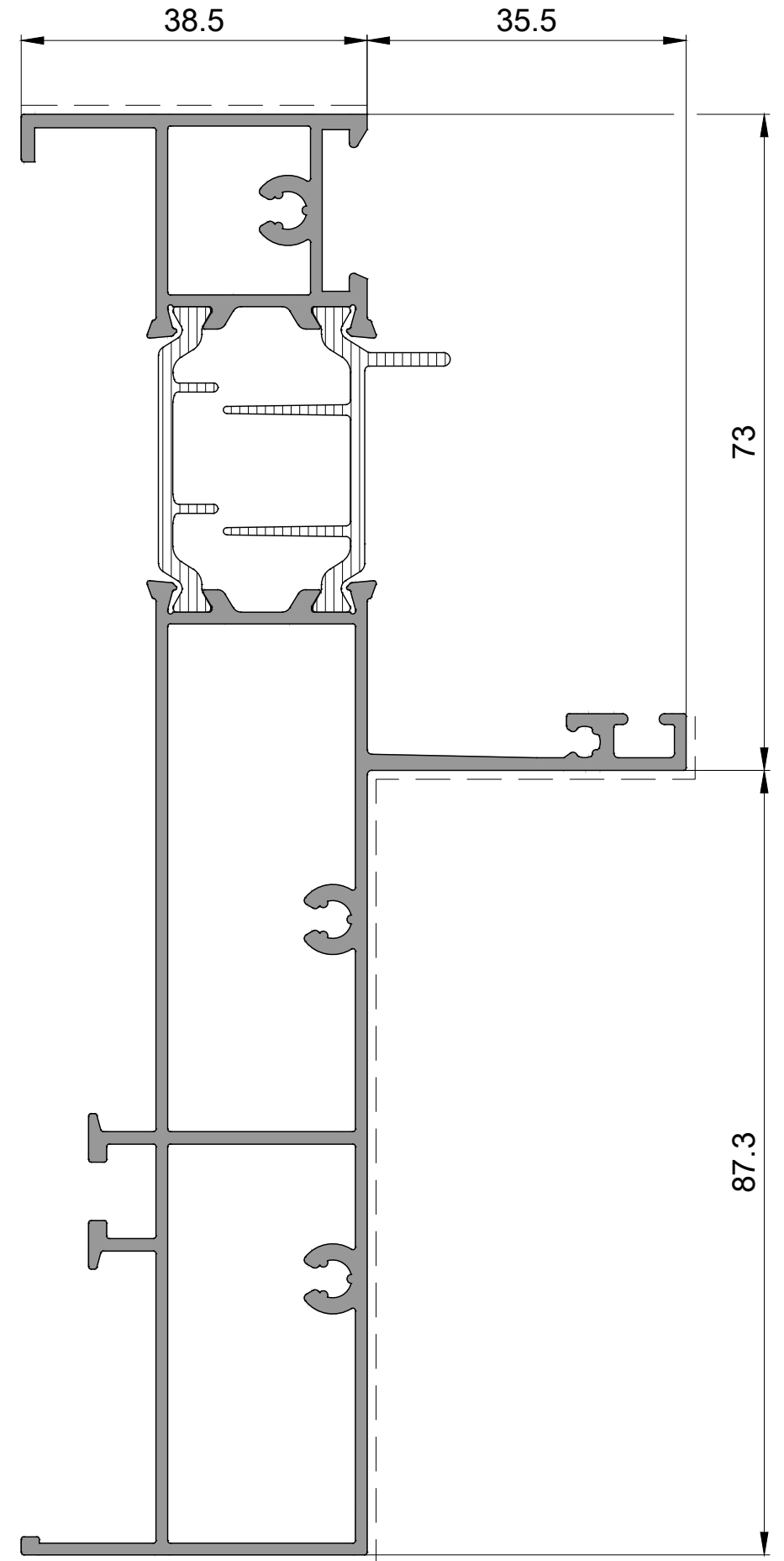

P 2610

Üst Kasa Profili
Top Frame Profile
2,530kg/mt

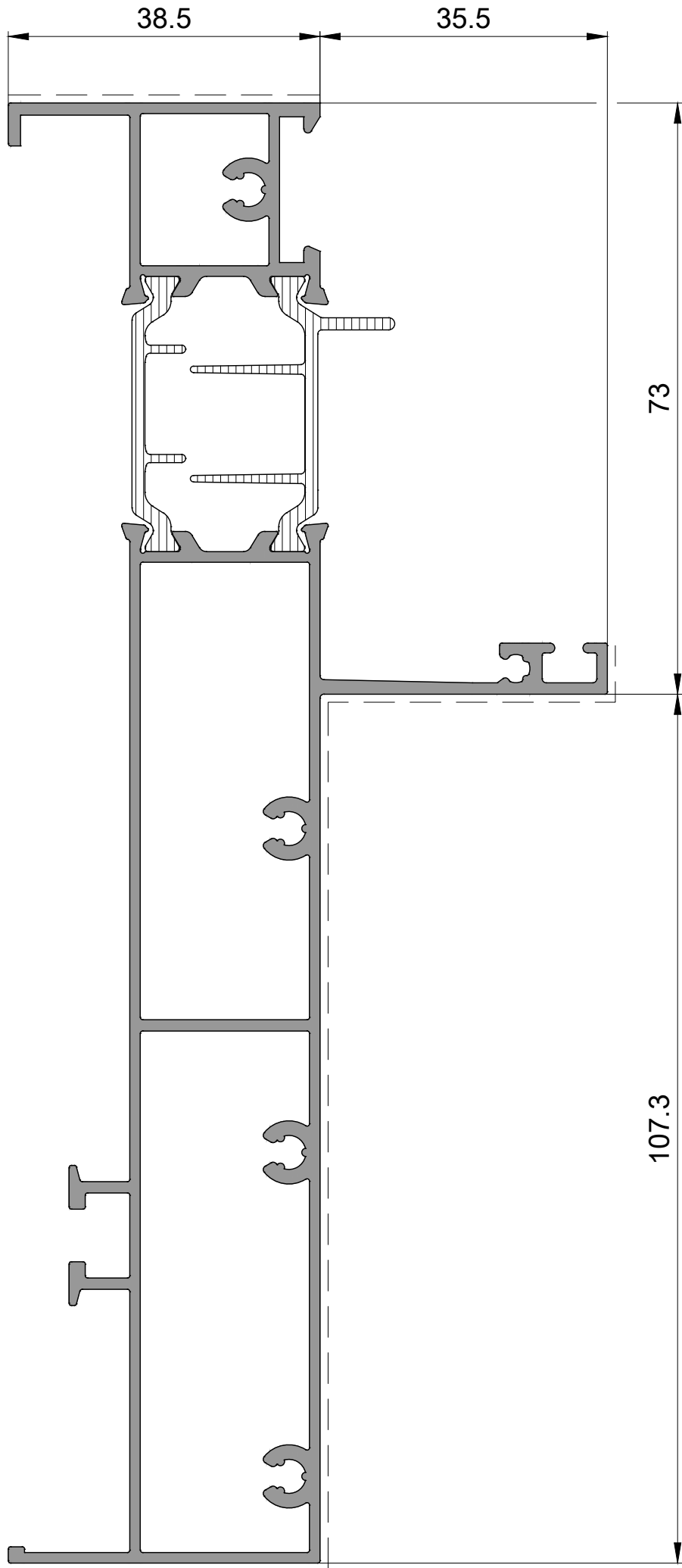

P 2611

Üst Kasa Profili
Top Frame Profile
2,670kg/mt

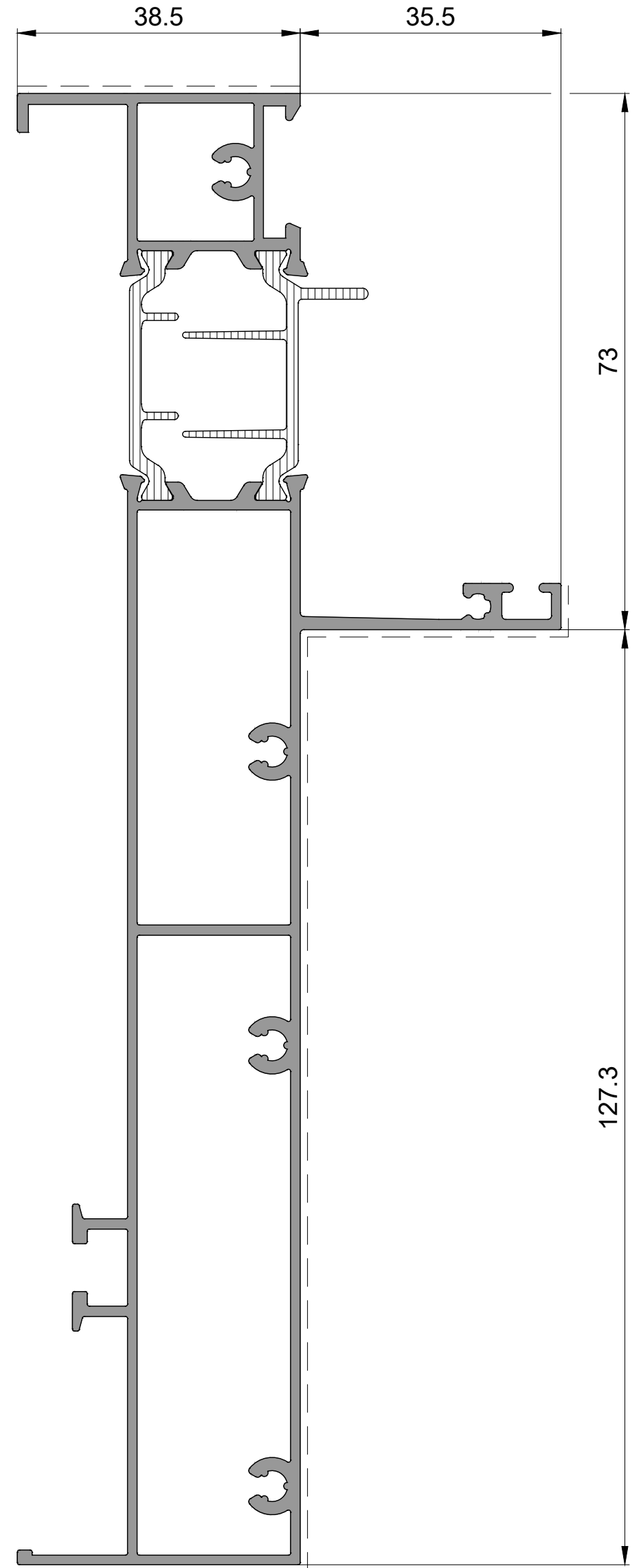

P 2612
Alt Kasa Profili
Bottom Frame Profile
1,925kg/mt

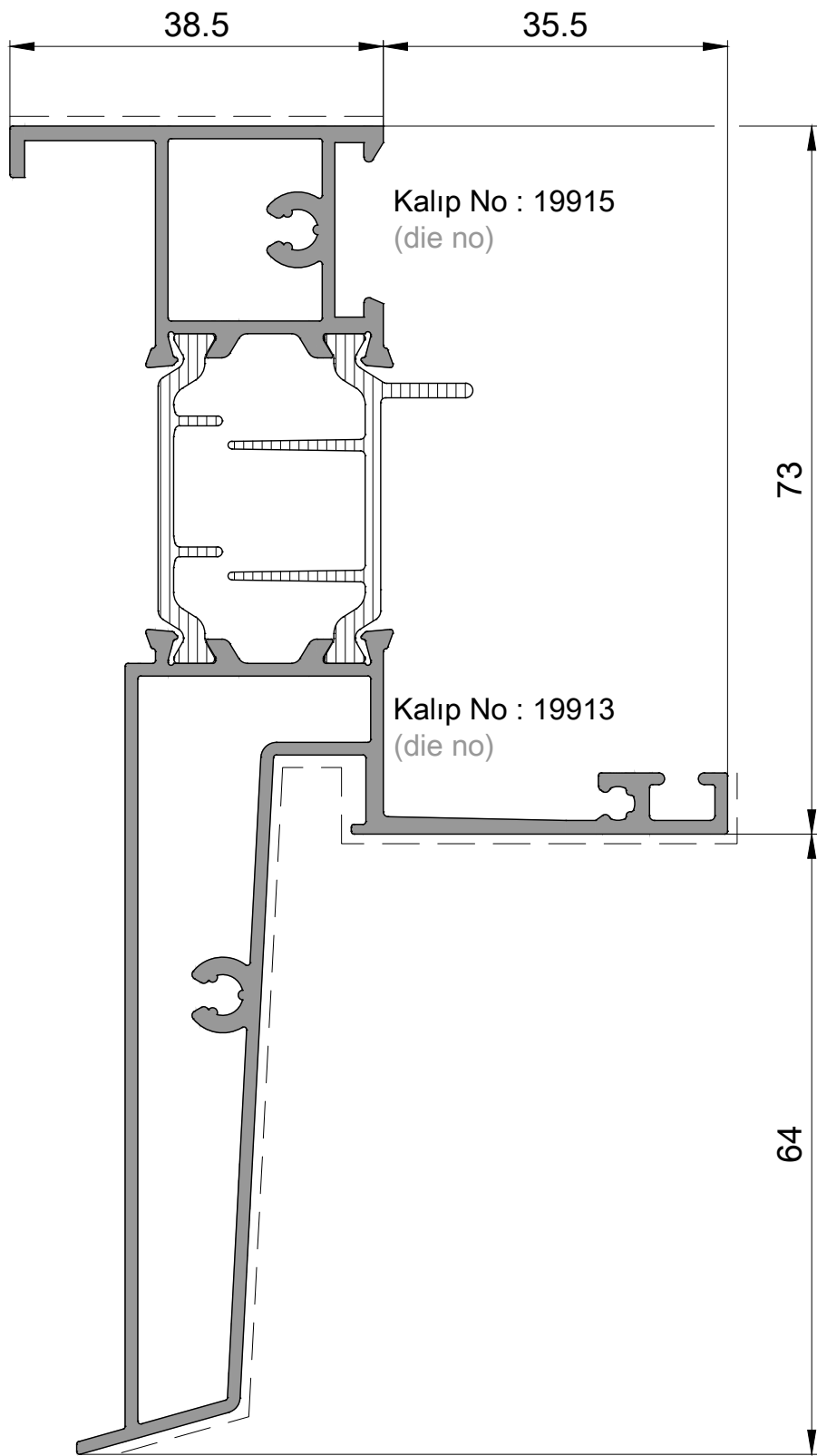

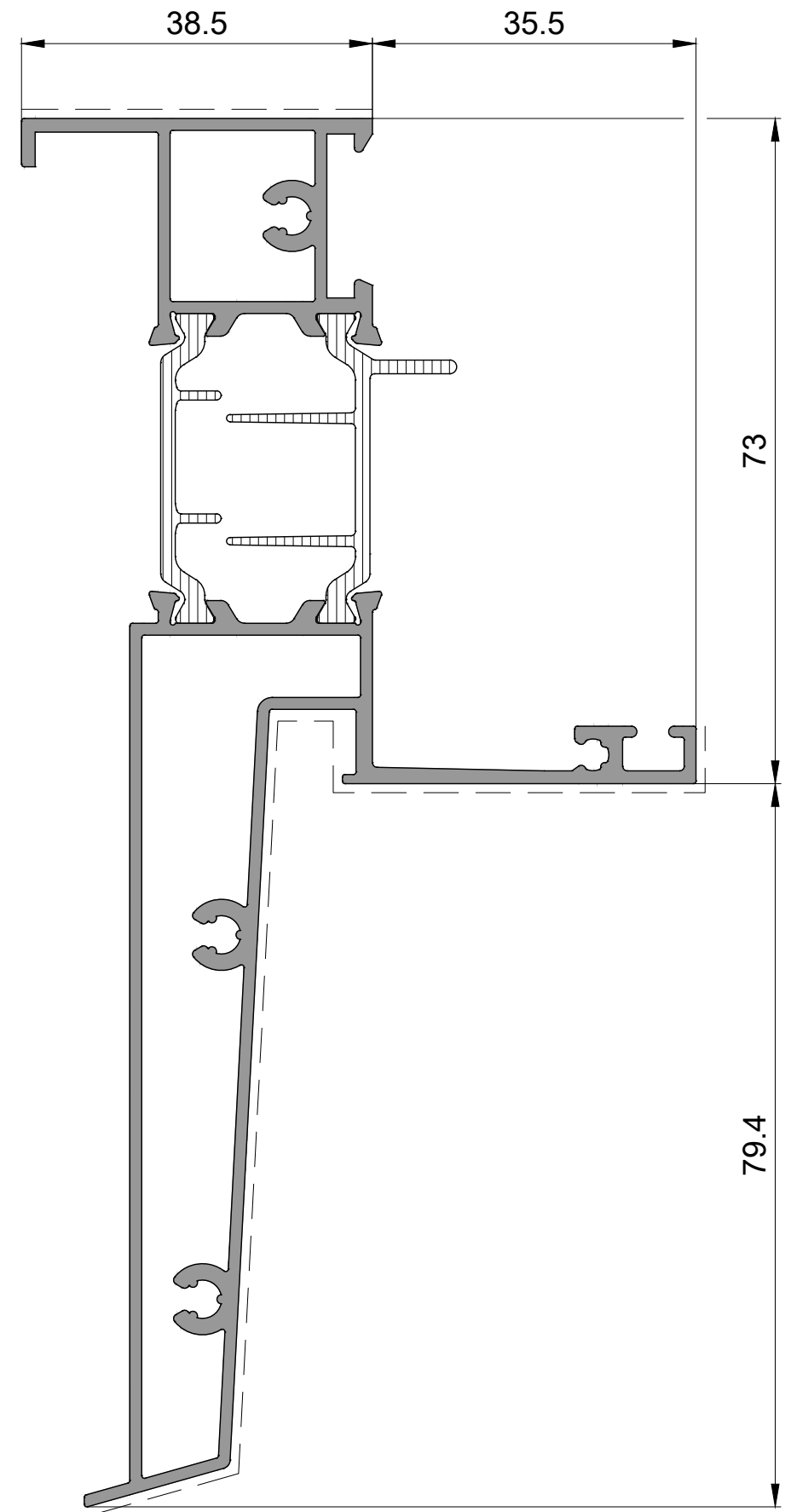

P 2613
Alt Kasa Profili
Bottom Frame Profile
2,095kg/mt

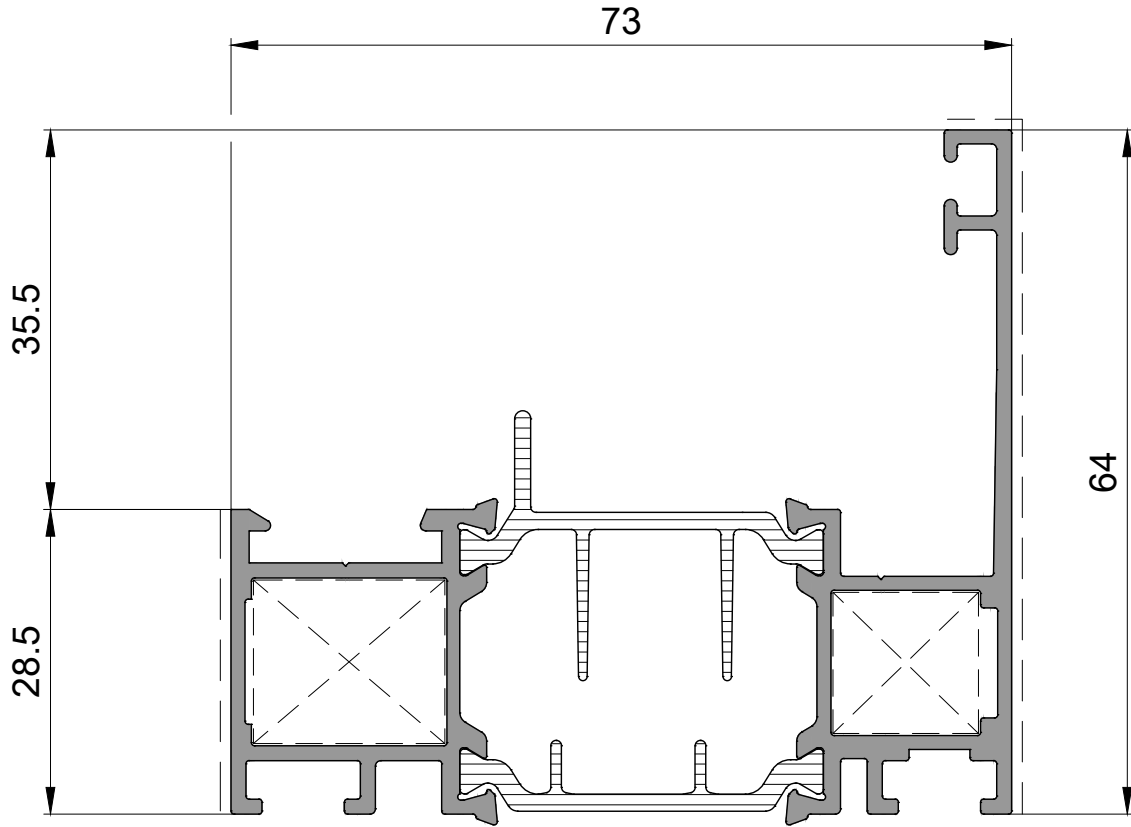



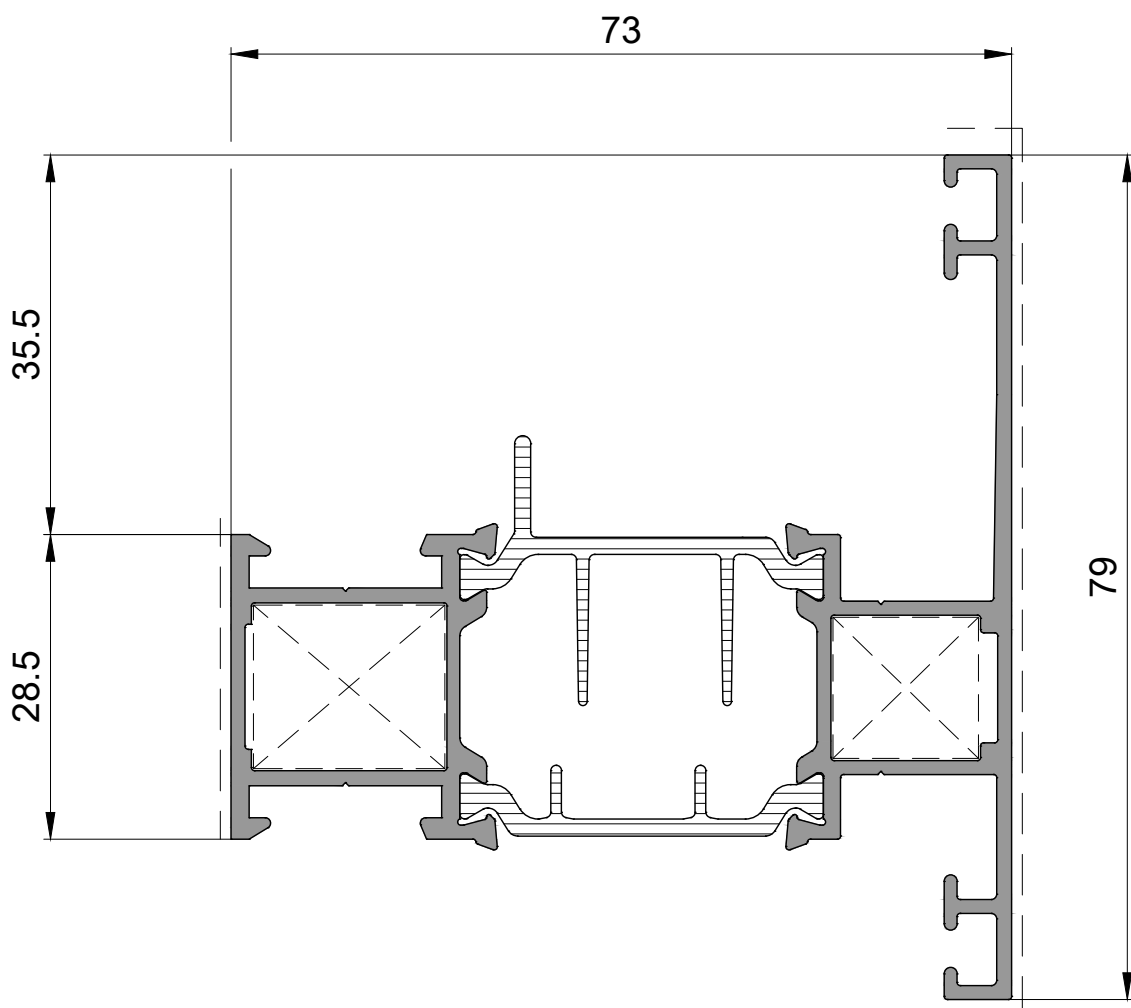

P 2614
Kasa Profili / Frame Profile
1,390kg/mt

I_x  24.81 cm⁴
 I_y  9.11 cm⁴



P 2615
Ortakayıt Profili / Mullion Profile
1,440kg/mt

I_x  25.36 cm⁴
 I_y  12.86 cm⁴

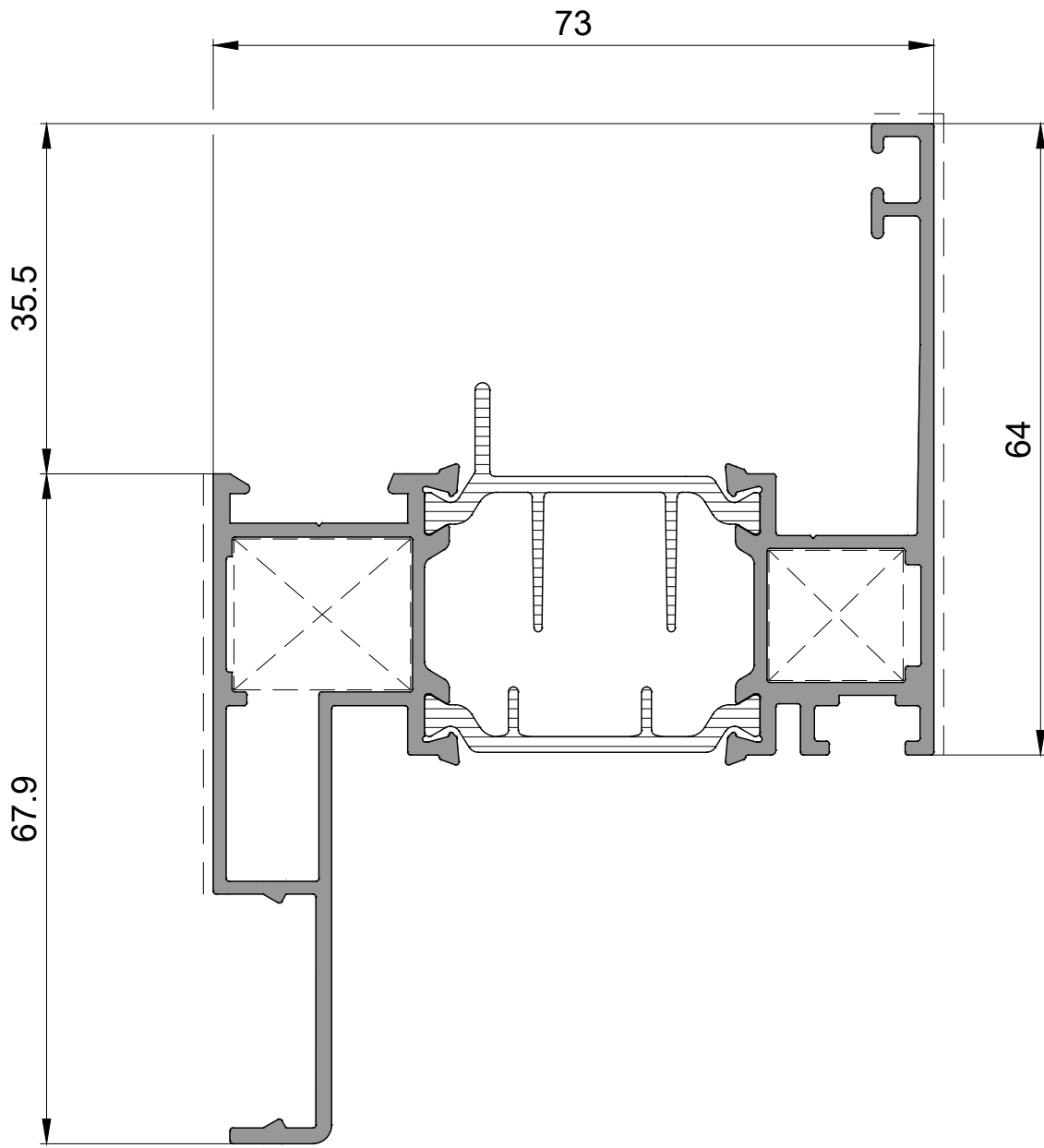

P 2645
Kasa Profili / Frame Profile
1,540kg/mt

I_x  38.97 cm⁴
 I_y  13.82 cm⁴

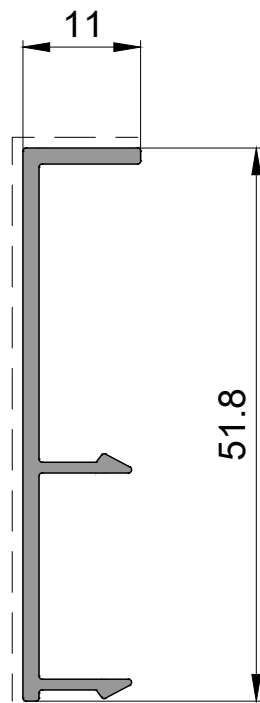

P 2588
Kapatma Profili / Closing Profile
0,300kg/mt

P 2616

Kanat Profili / Sash Profile
1,450kg/mt

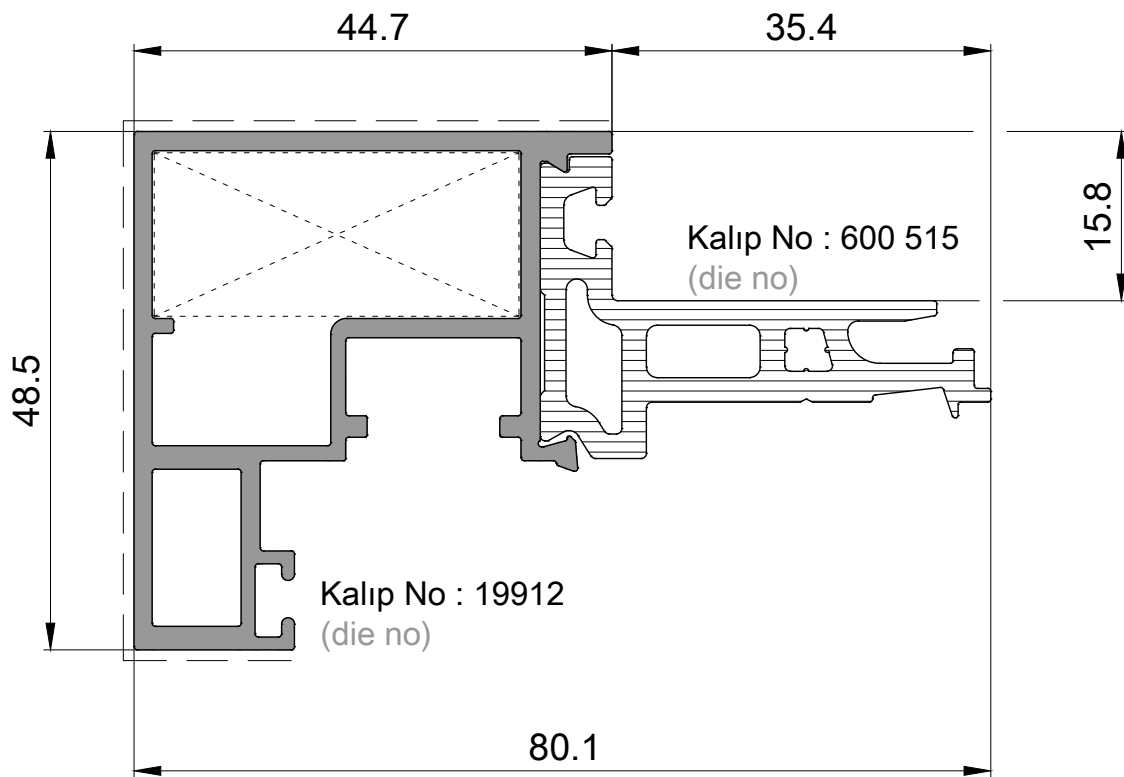

I_x  5.03 cm⁴
 I_y  11.38 cm⁴

P 2617

Kanat Profili / Sash Profile
1,150kg/mt

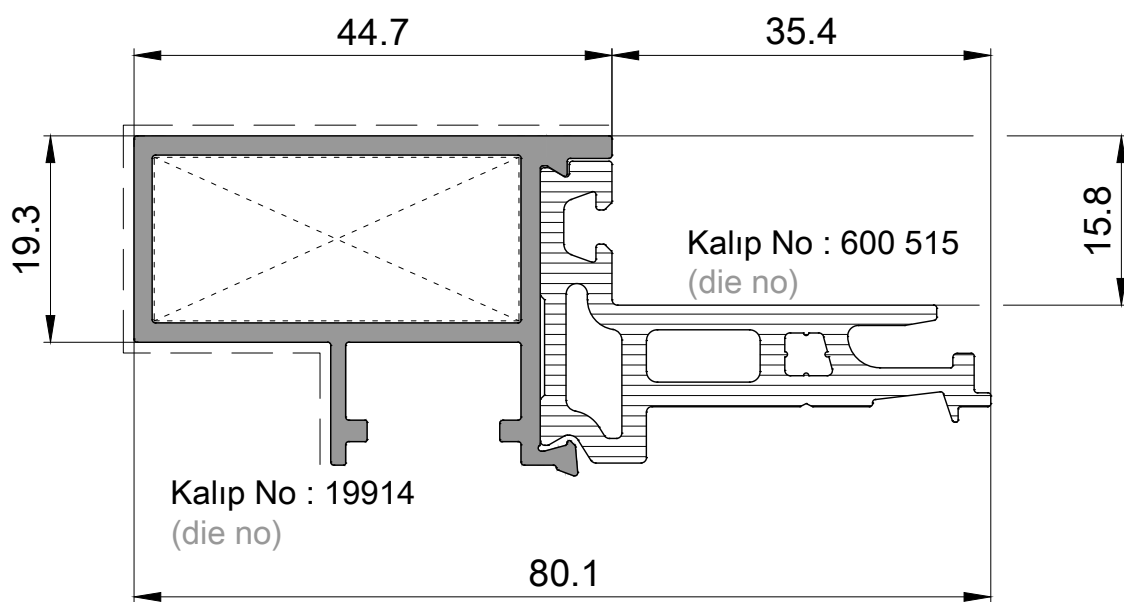

I_x  5.07 cm⁴
 I_y  2.48 cm⁴

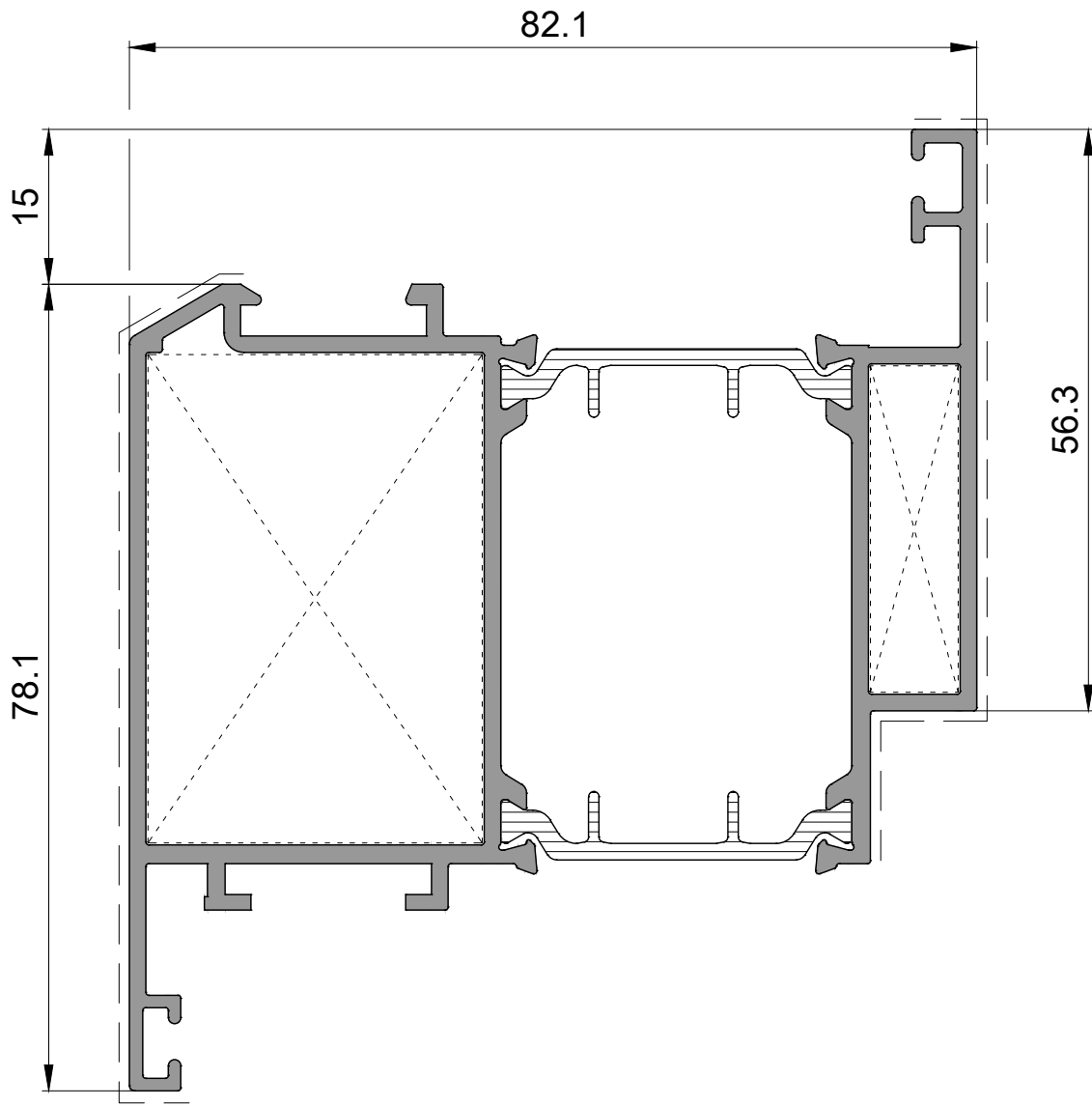

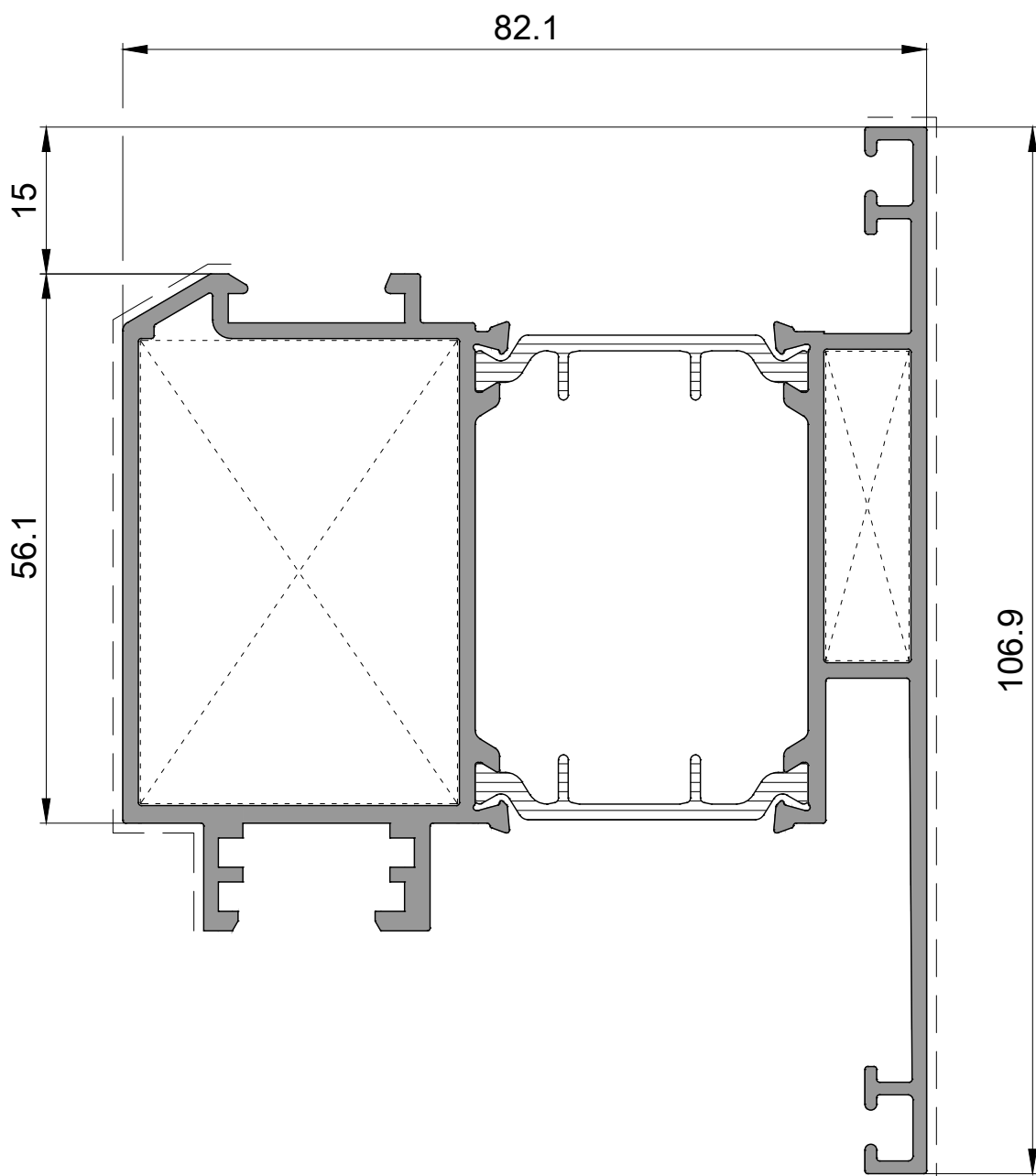

P 2618
Kanat Profili / Sash Profile
1,945kg/mt

I_x  50.66 cm⁴
 I_y  26.42 cm⁴



P 2619
Kanat Profili / Sash Profile
2,200kg/mt

I_x  51.18 cm⁴
 I_y  47.89 cm⁴

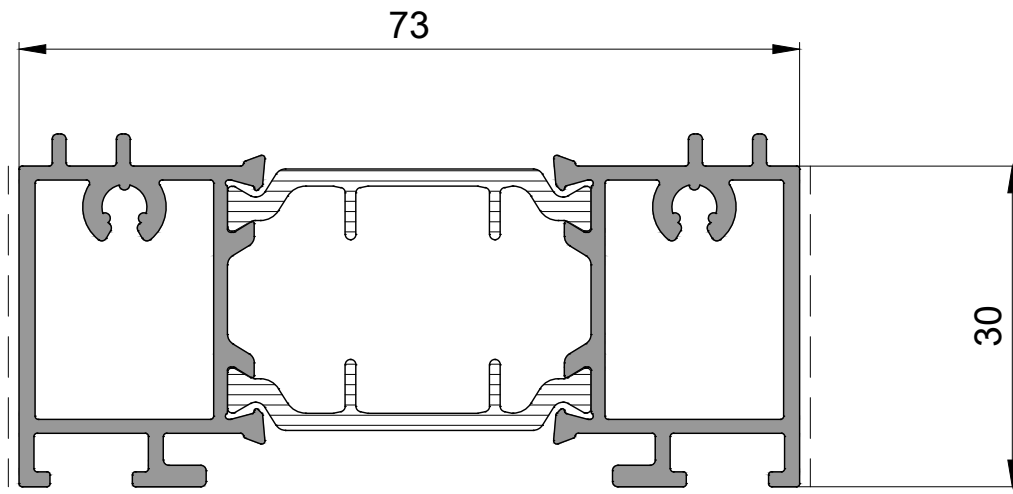

P 2620
Kasa Ek Profil / Elargisseur Profile
1,280kg/mt

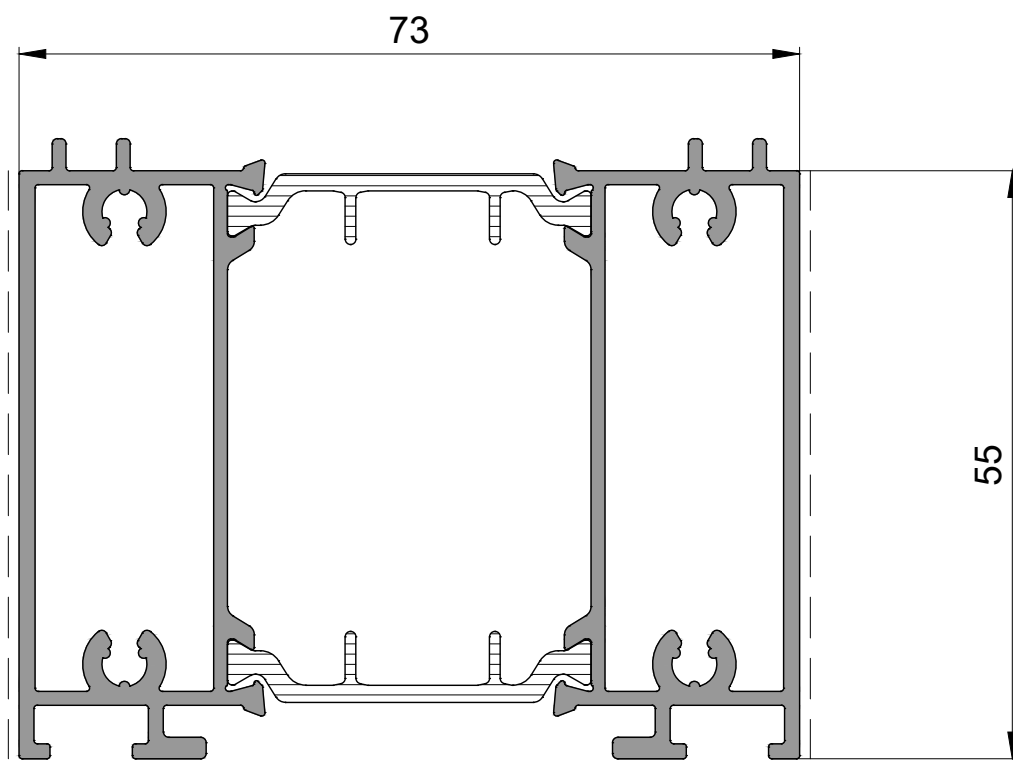

P 2621
Kasa Ek Profil / Elargisseur Profile
1,785kg/mt

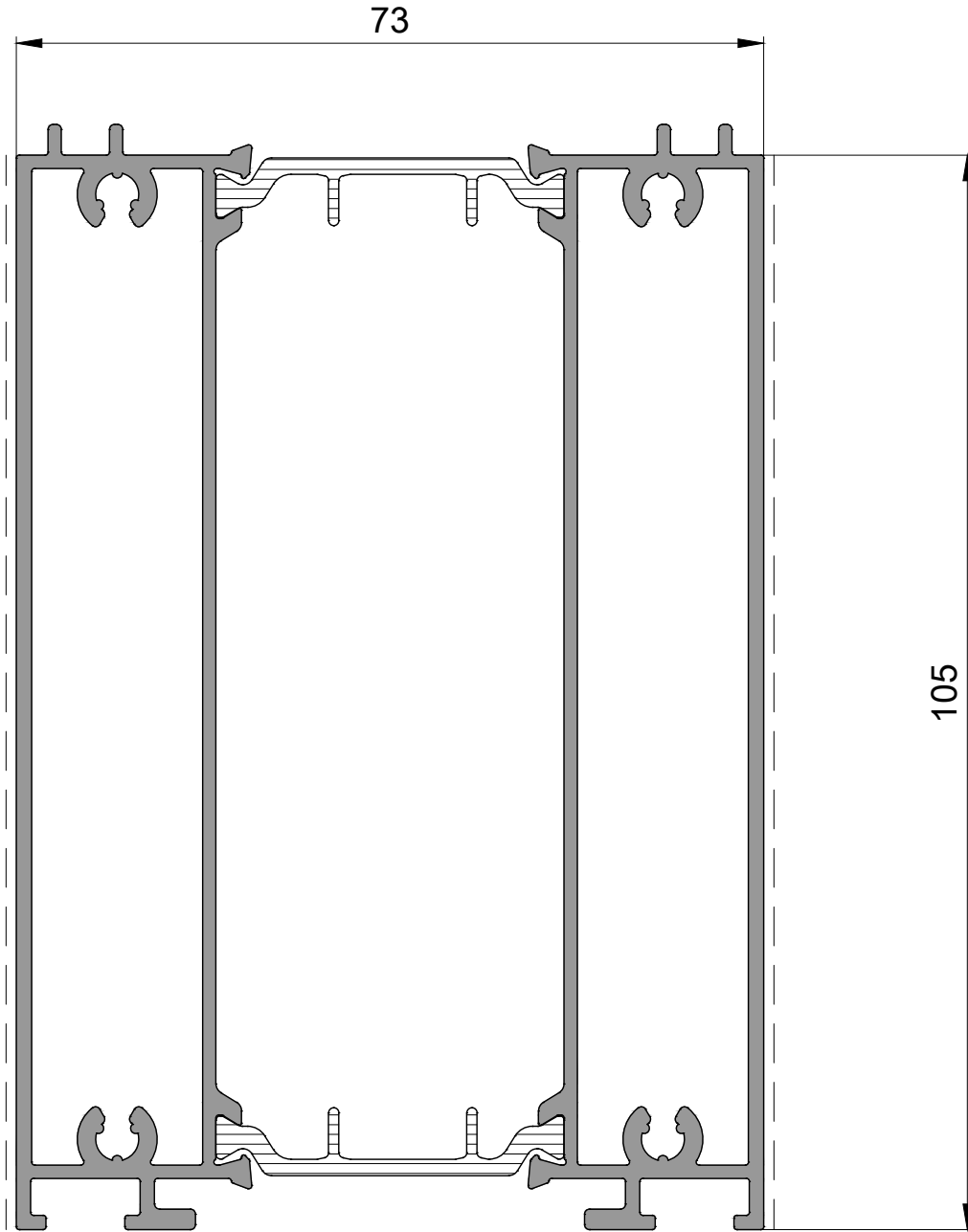

P 2622

Kasa Ek Profil / Elargisseur Profile
2,545kg/mt

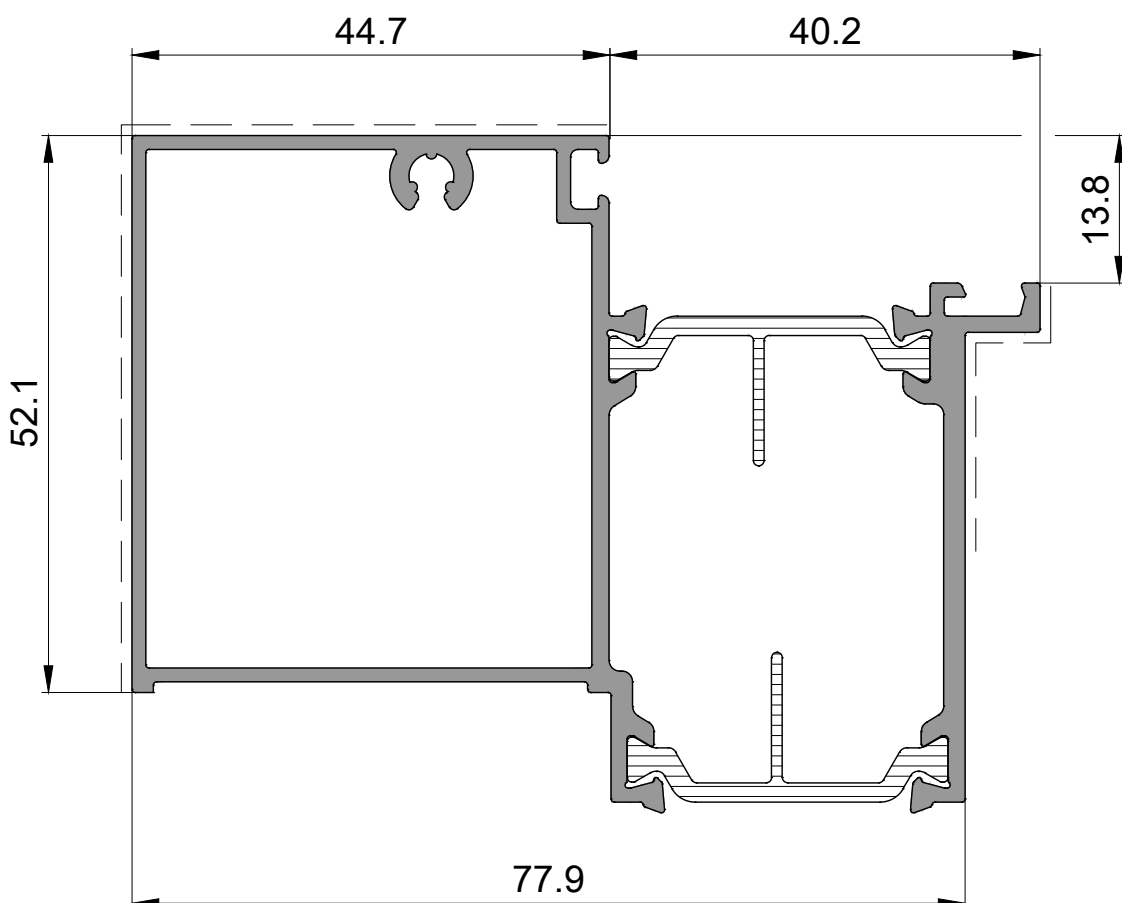

P 2623

Kanat Ek Profil / Adepter Profile
1,520kg/mt

lx

27.98 cm⁴

ly

17.40 cm⁴

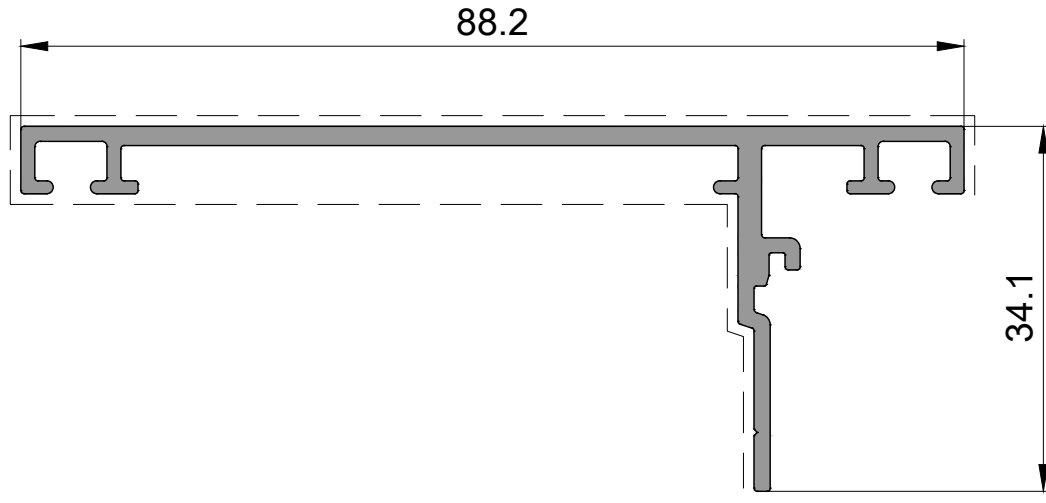

P 2624
Adaptör Profili / Adepter Profile
0,705kg/mt

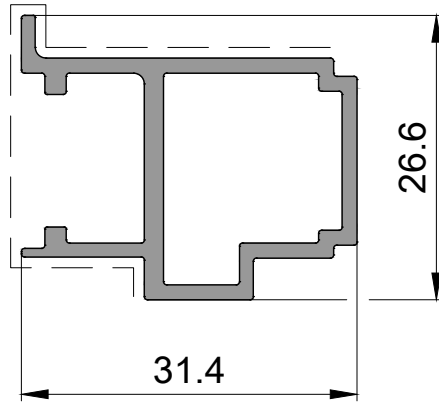

P 2625
Adaptör Profili / Adepter Profile
0,440kg/mt

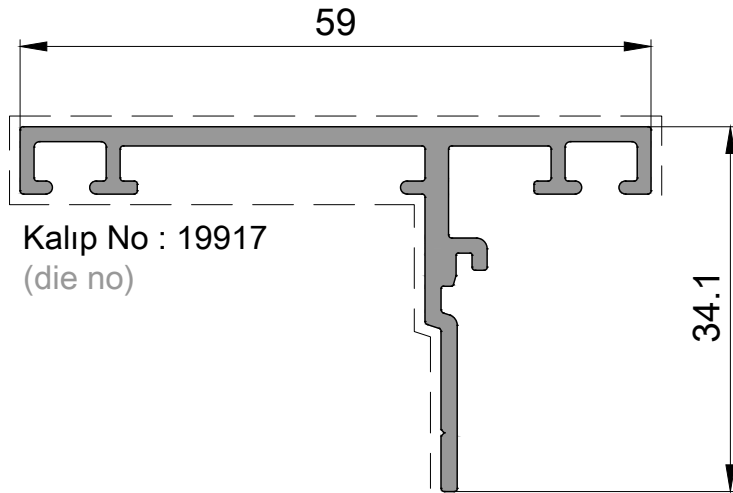

P 2626
Adaptör Profili / Adepter Profile
0,560kg/mt

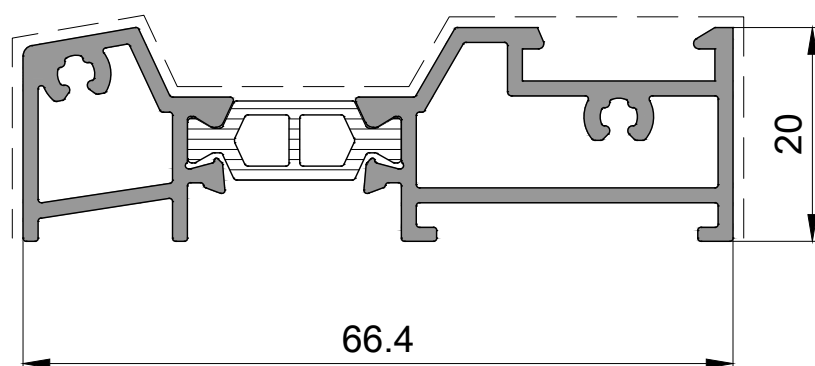

P 2627
Eşik Profili / Threshold Profile
0,910kg/mt

P 2628

Pervaz Profili / Tape Isolation
0,325kg/mt

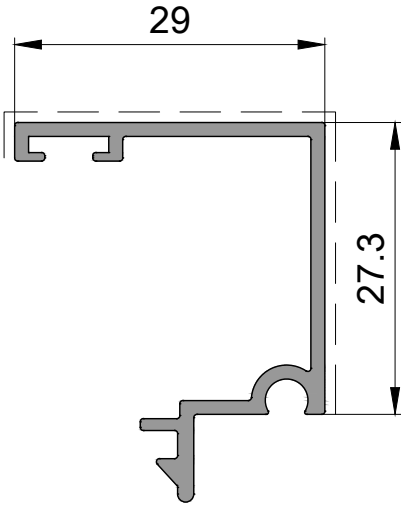

P 2629

Pervaz Profili / Tape Isolation
0,395kg/mt

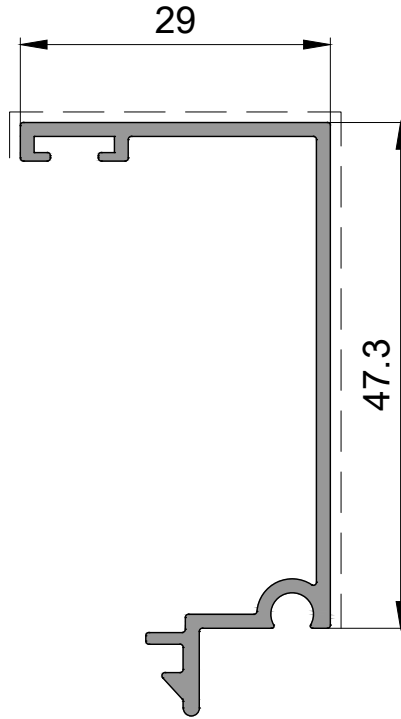

P 2630

Pervaz Profili / Tape Isolation
0,465kg/mt

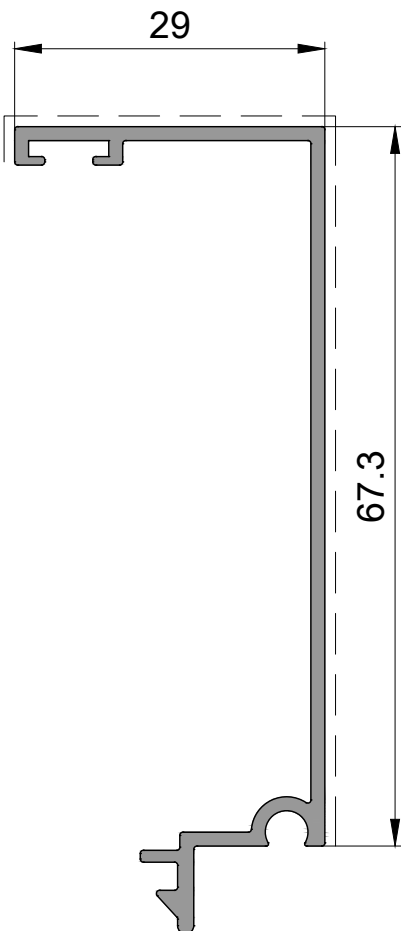

P 2631

Pervaz Profili / Tape Isolation
0,535kg/mt

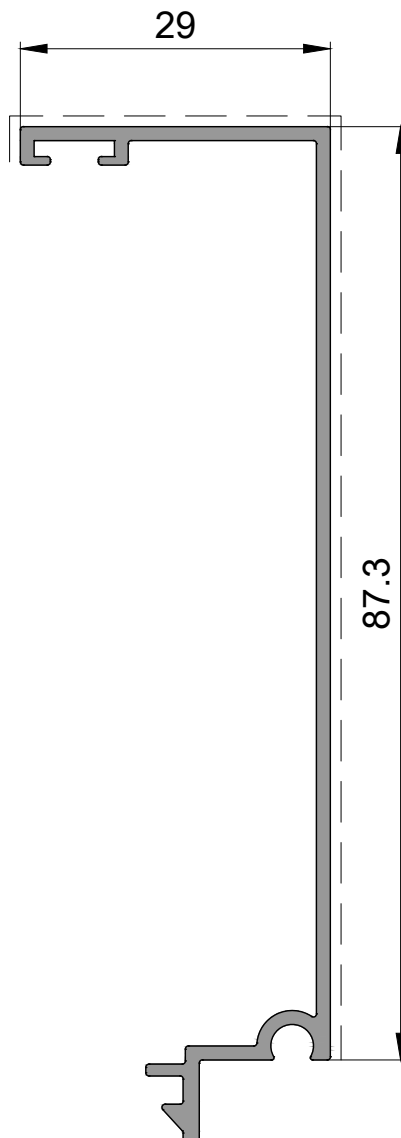

P 2632
Pervaz Profili / Tape Isolation
0,605kg/mt

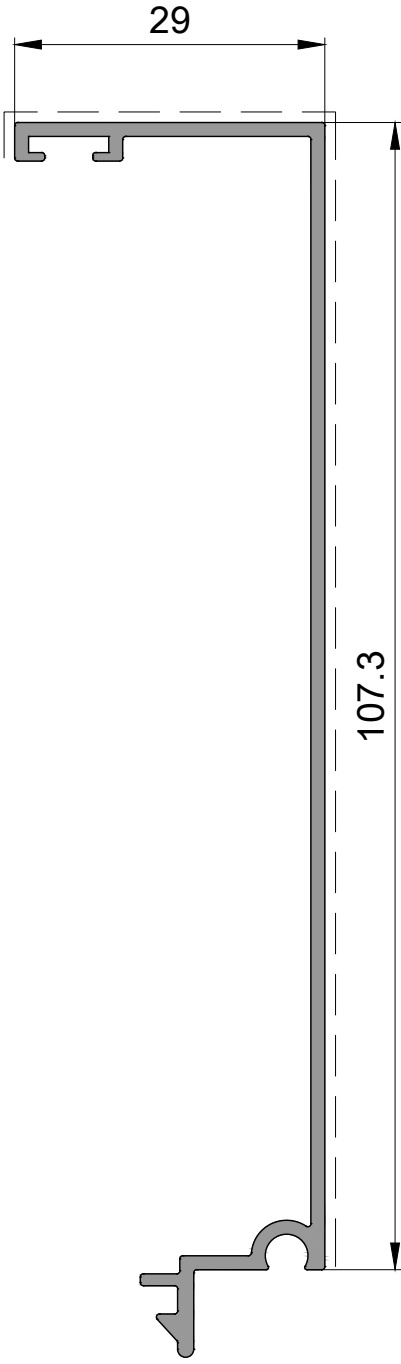

P 2633
Pervaz Profili / Aile De Recouvrement
0,170kg/mt

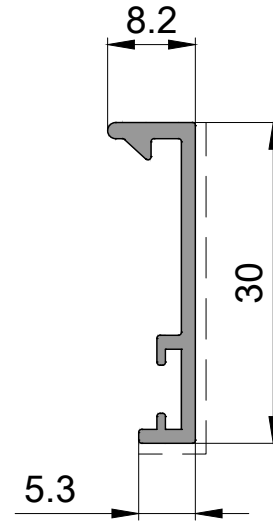

P 2635
Denizlik Profili / Piece D'appui
0,660kg/mt

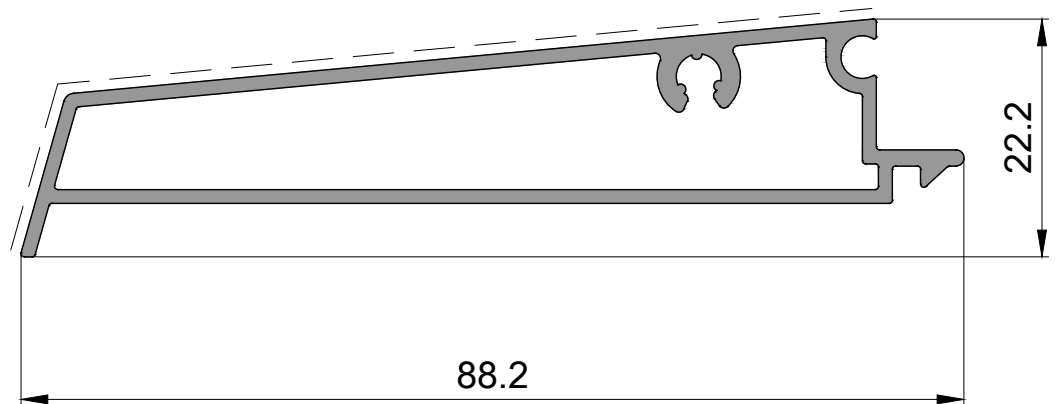
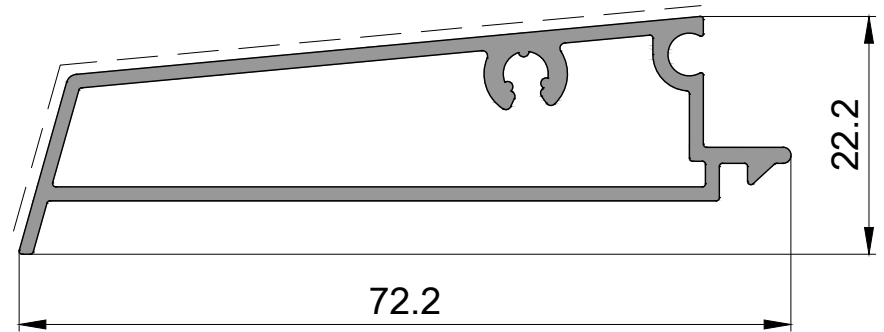

P 2636
Denizlik Profili / Piece D'appui
0,765kg/mt

P 2634

Pervaz Profili / Aile De Recouvrement
0,240kg/mt

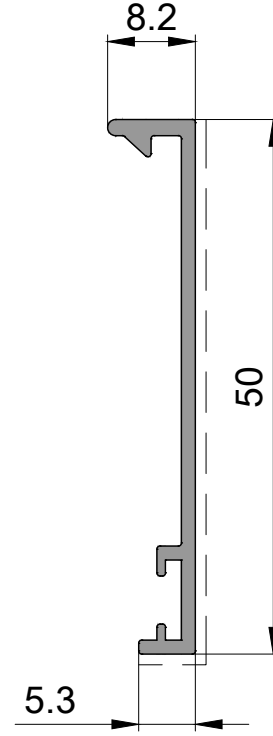

P 2637

Adaptör Profili / Adepter Profile
0,330kg/mt

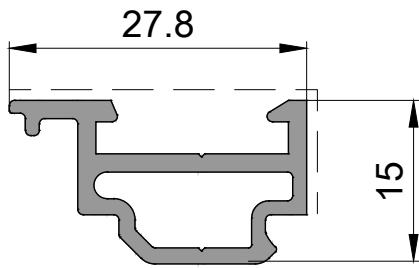

P 1020

Tij Profili / rodprofile
0,105kg/mt

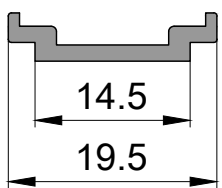

Kalıp : 12769
(die no)

eloxal - anodising

P 2638

Kapı Çıta Profili / door slat profile
0,225kg/mt

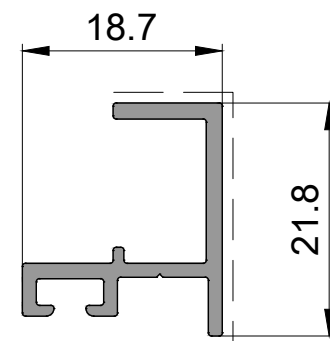

P 2639

Çıta Profili / glazing bead
0,410kg/mt

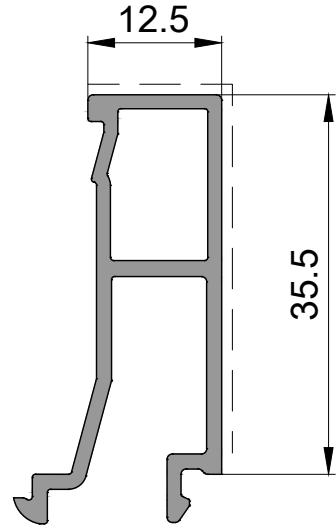

P 2640

Çıta Profili / glazing bead
0,445kg/mt

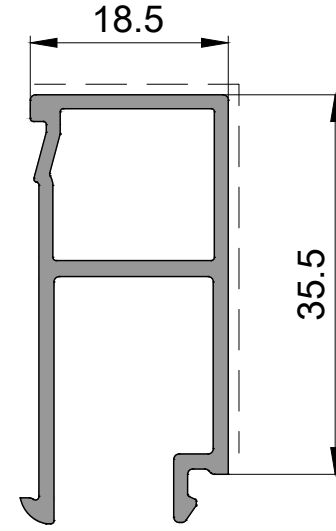

P 2641

Çıta Profili / glazing bead
0,490kg/mt

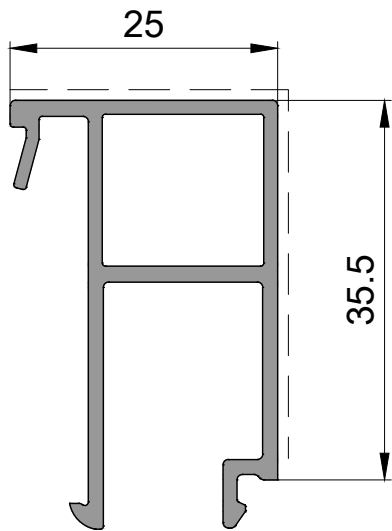

P 2642

Çıta Profili / glazing bead
0,515kg/mt

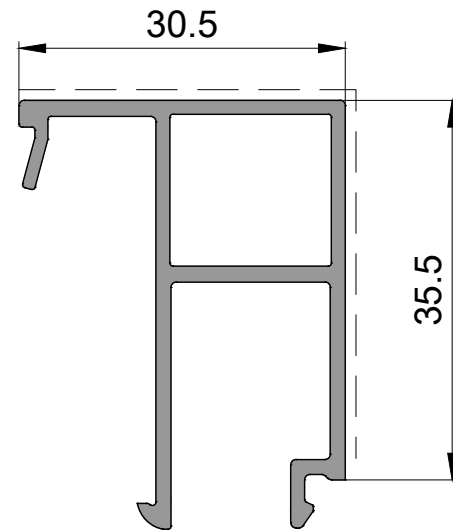

P 2643

Çıta Profili / glazing bead
0,540kg/mt

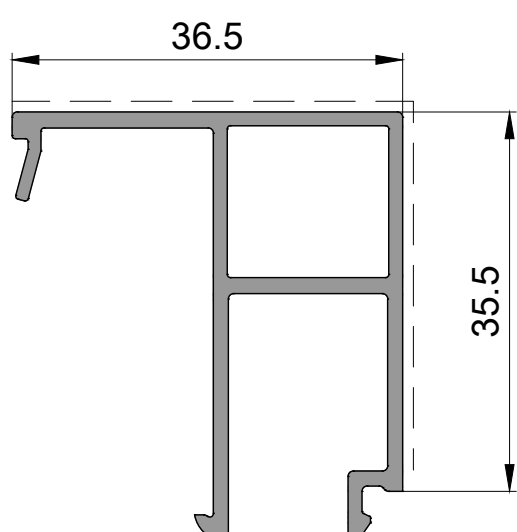

P 1850

Çıta Profili / glazing bead
0,100kg/mt

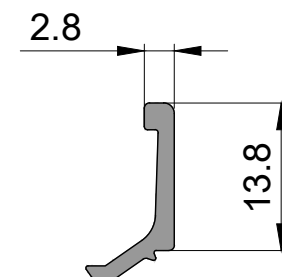

Kalıp / die no : 17089

P 2180

Çıta Profili / glazing bead
0,240kg/mt

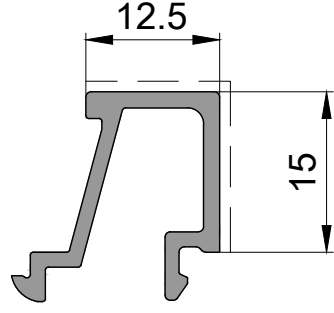

P 2181

Çıta Profili / glazing bead
0,285kg/mt

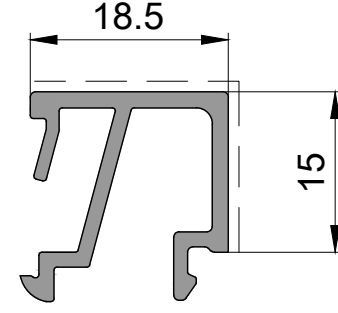

Kalıp / die no : 18279

P 2182

Çıta Profili / glazing bead
0,295kg/mt

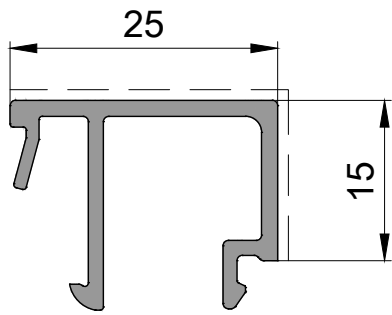

Kalıp / die no : 18096

P 2183

Çıta Profili / glazing bead
0,320kg/mt

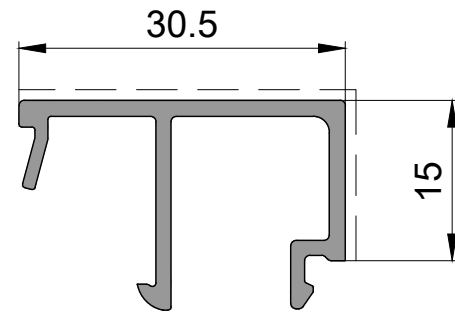

P 2184

Çıta Profili / glazing bead
0,340kg/mt

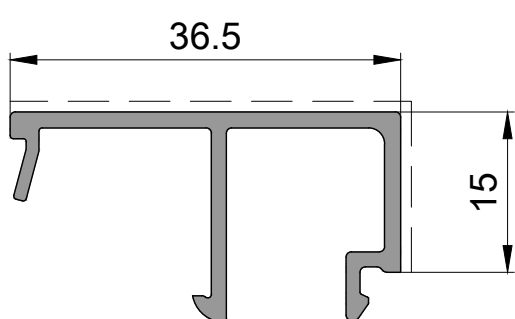

P 2644

Kapı Çıta Profili / door slat
0,370kg/mt

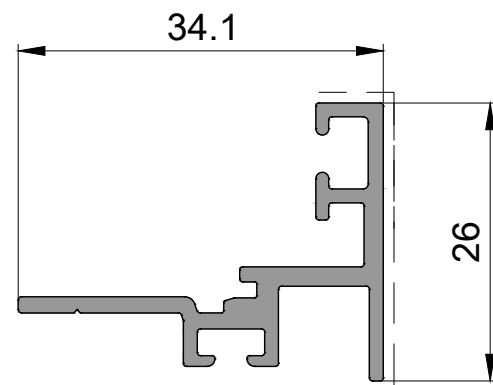

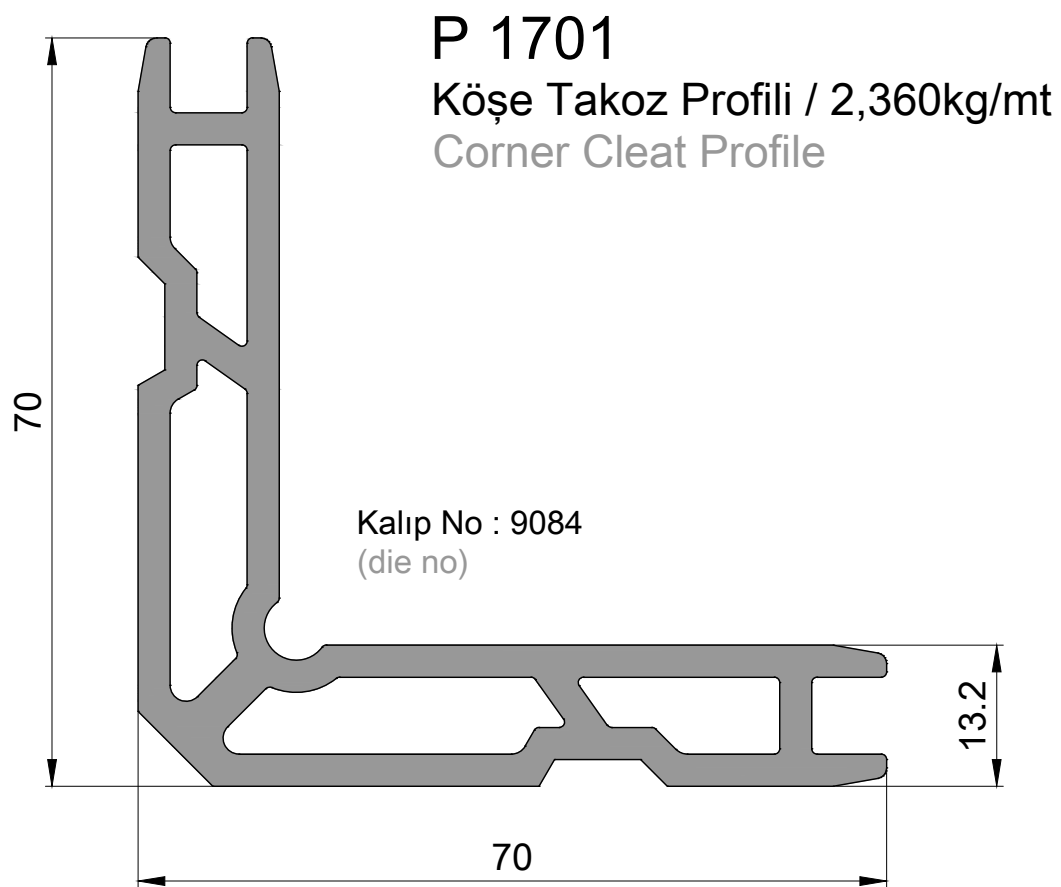
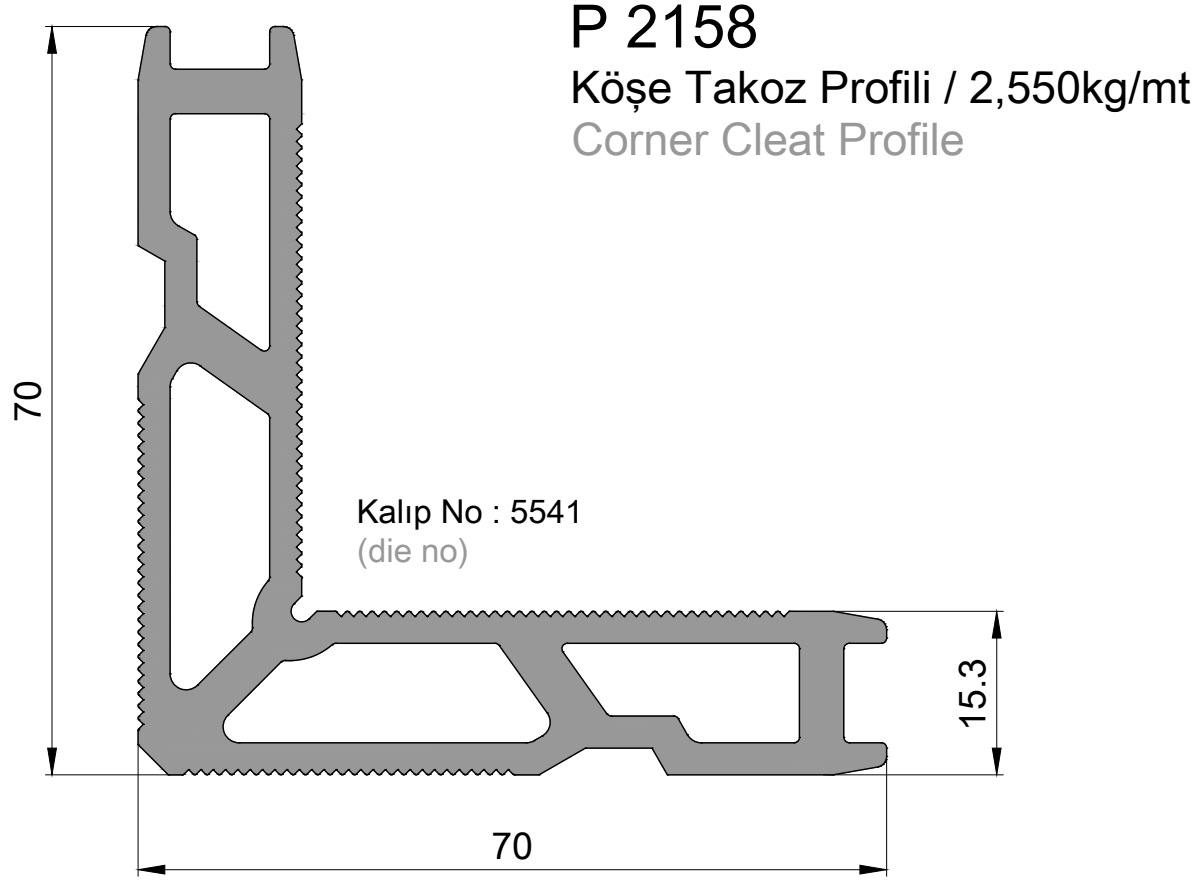

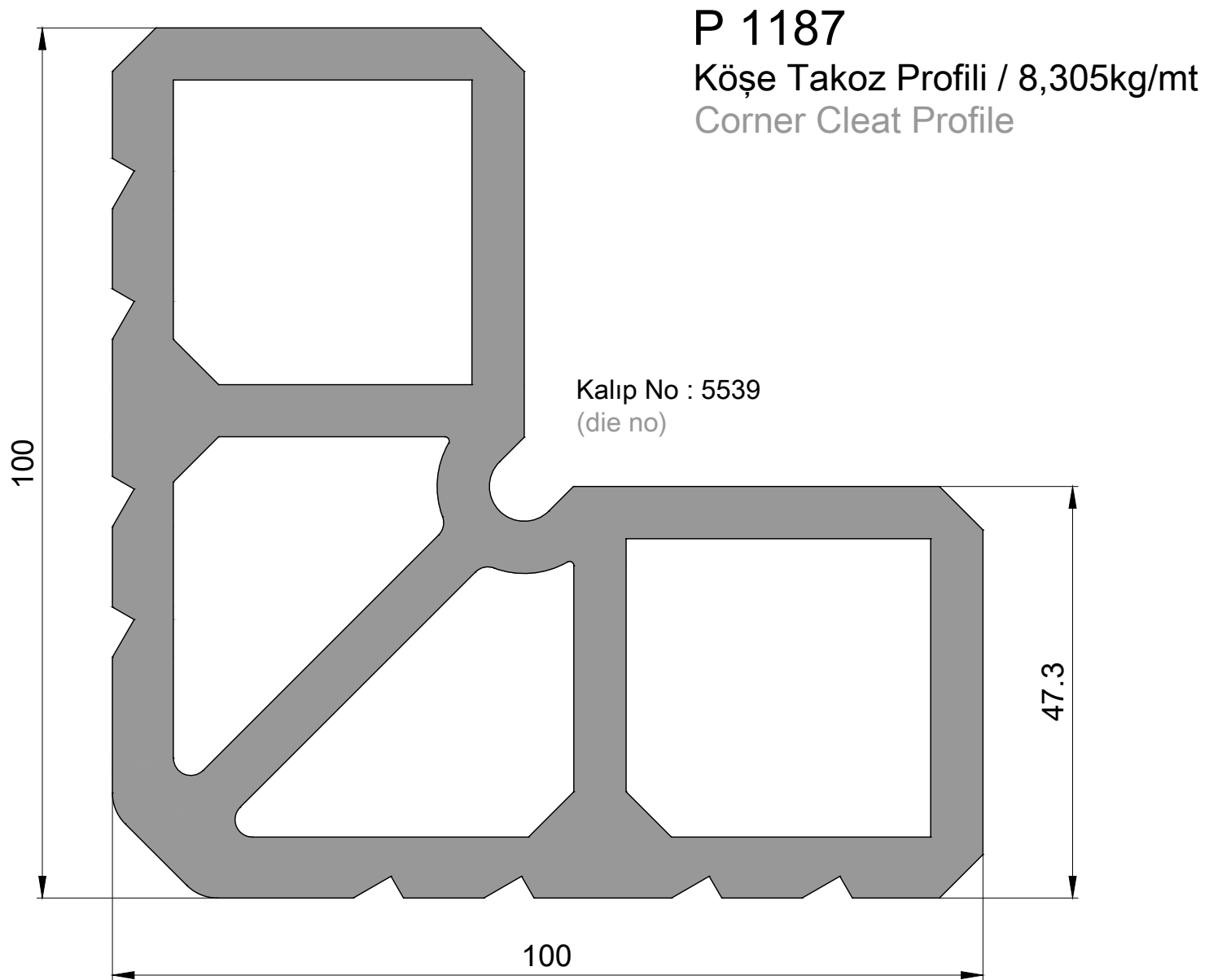
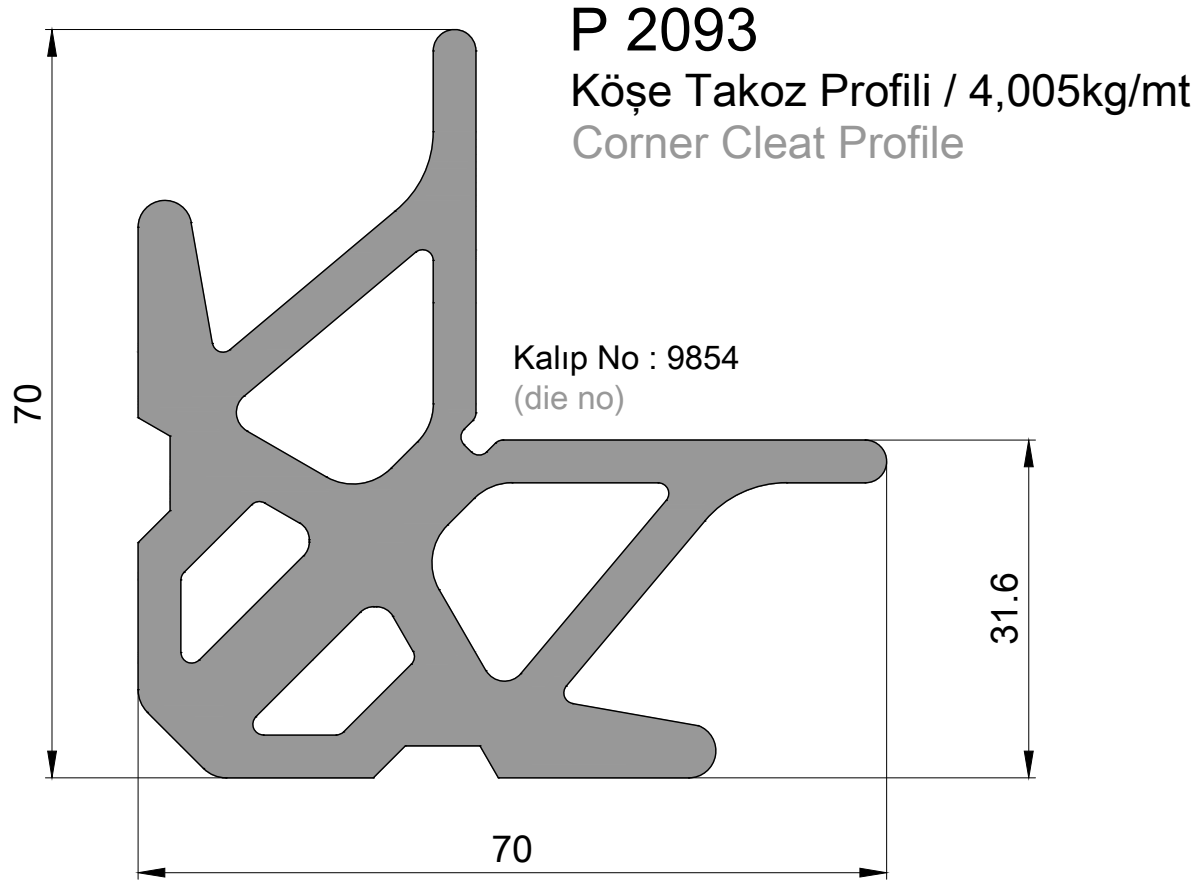

ALFA

GİZLİ KANATLI PENCERE ve KAPI SİSTEMİ CONCEALED SASH WINDOW and DOOR SYSTEM

GİZLİ KANATLI PENCERE PRENSİP SİSTEM DETAYLARI PRINCIPAL SECTIONS for CONCEALED SASH WINDOW SYSTEM

100mm YALITIMLI SOL YAN DETAY
100mm isolation with left side detail

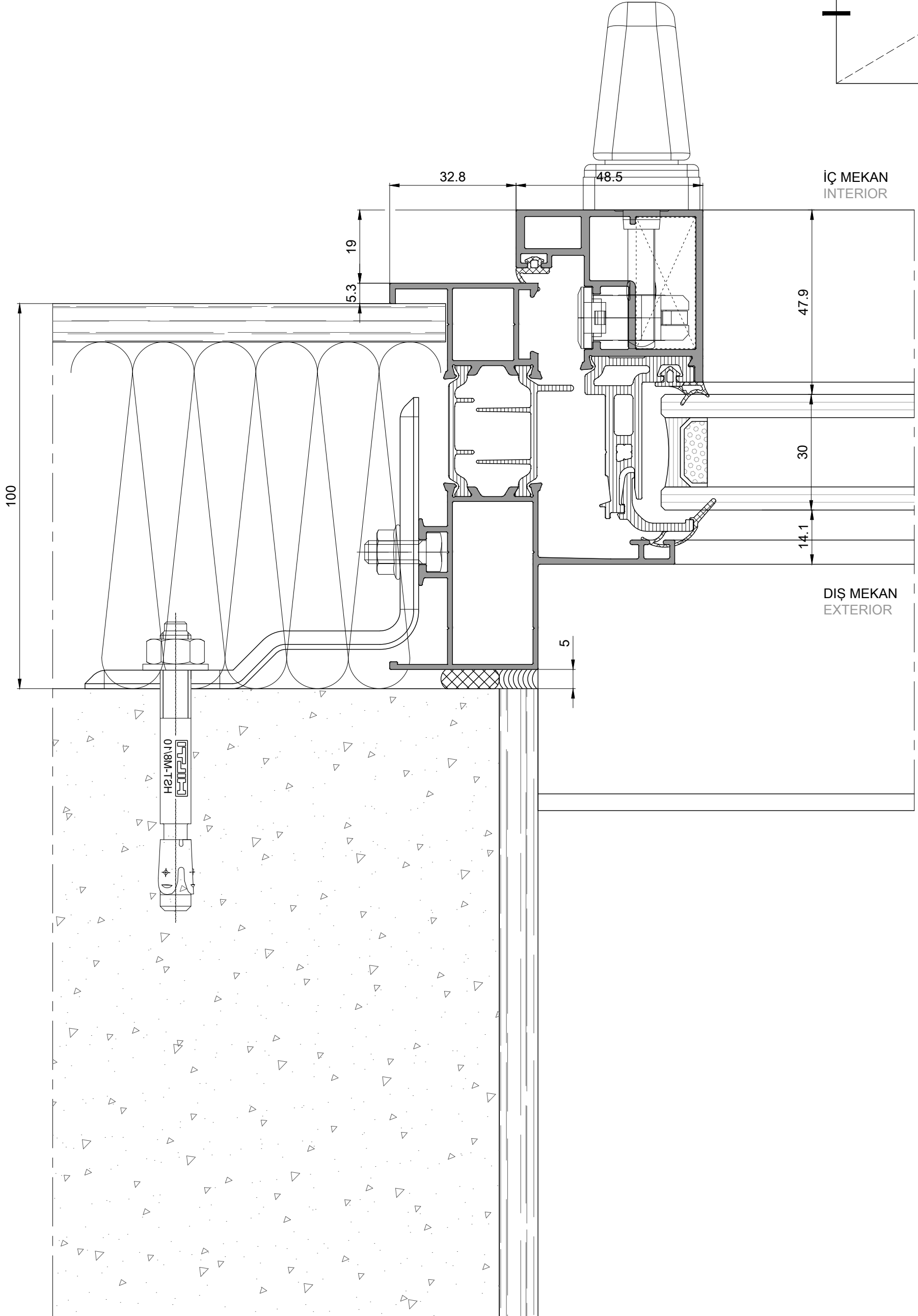

120mm YALITIMLI SOL YAN DETAY
120mm isolation with left side detail

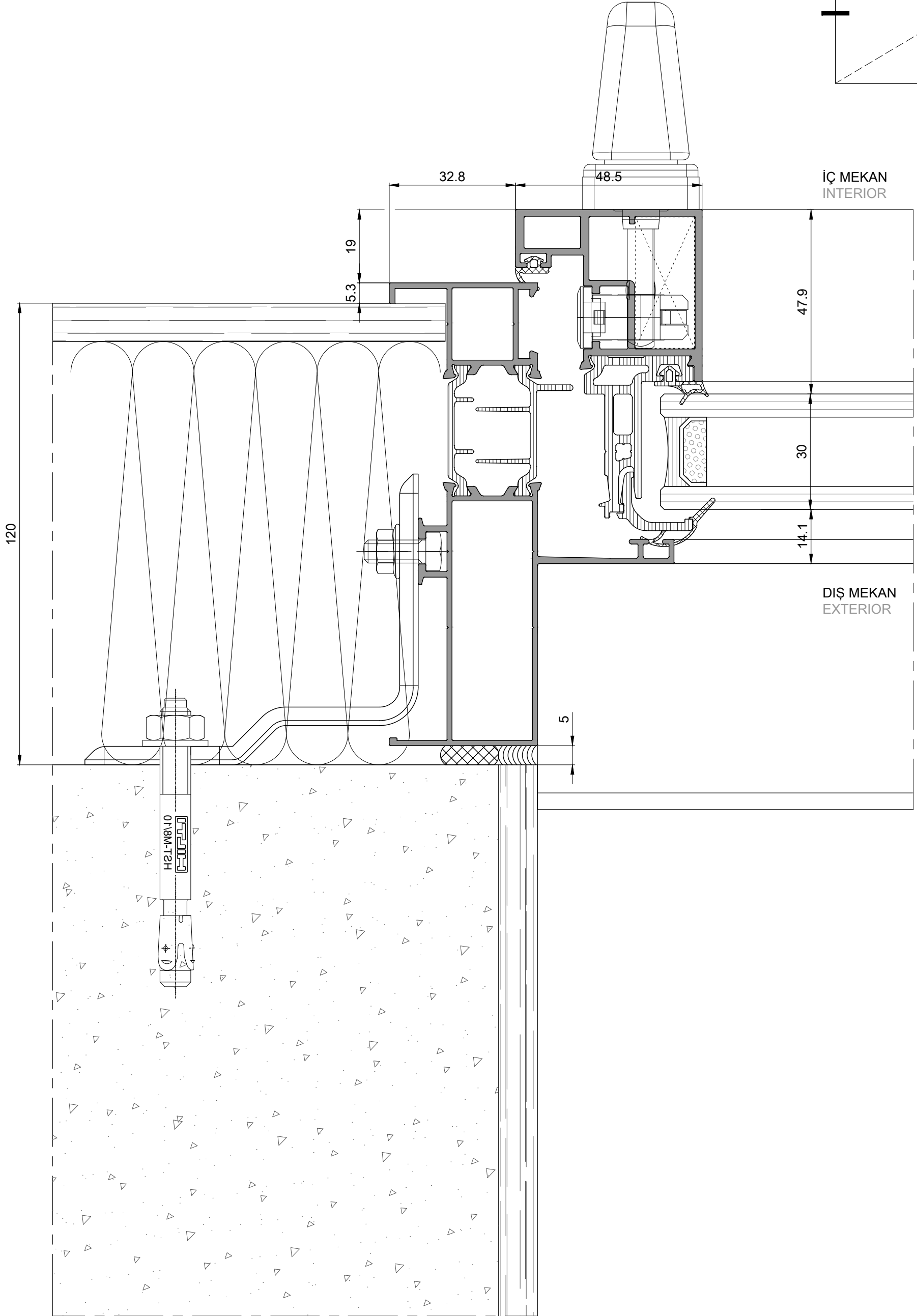

140mm YALITIMLI SOL YAN DETAY
140mm isolation with left side detail

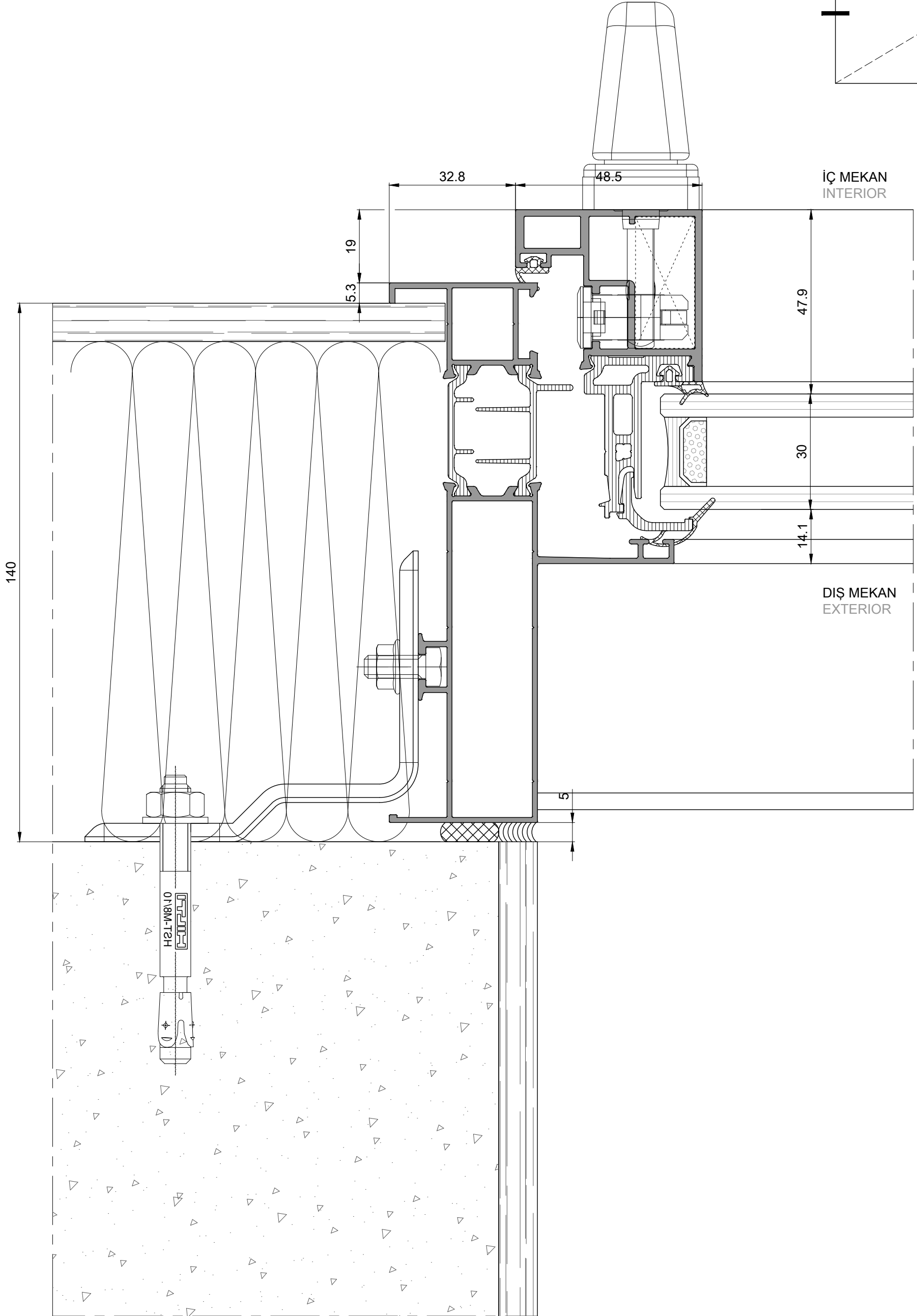

160mm YALITIMLI SOL YAN DETAY
160mm isolation with left side detail

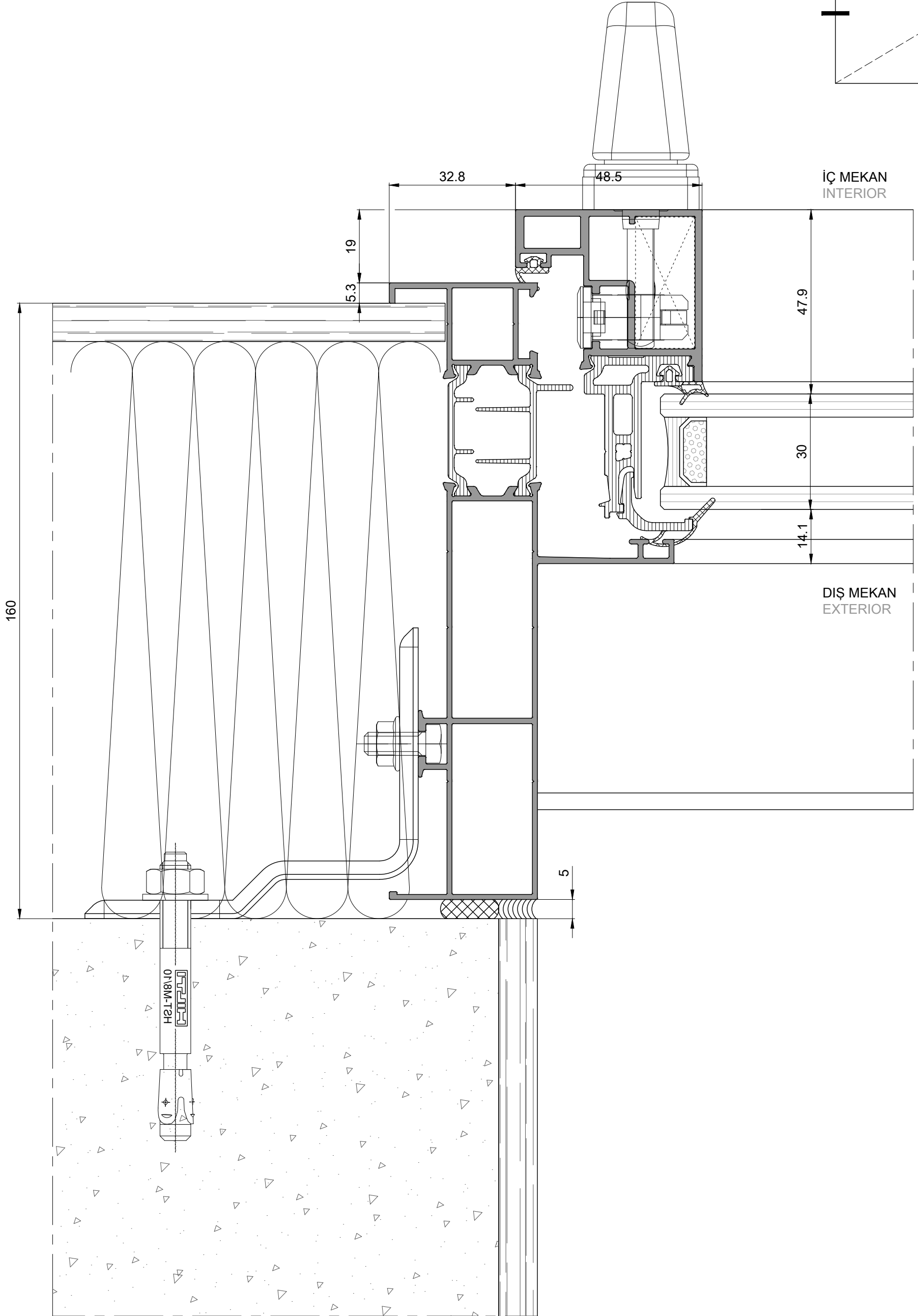
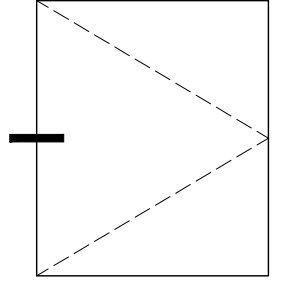

180mm YALITIMLI SOL YAN DETAY
180mm isolation with left side detail

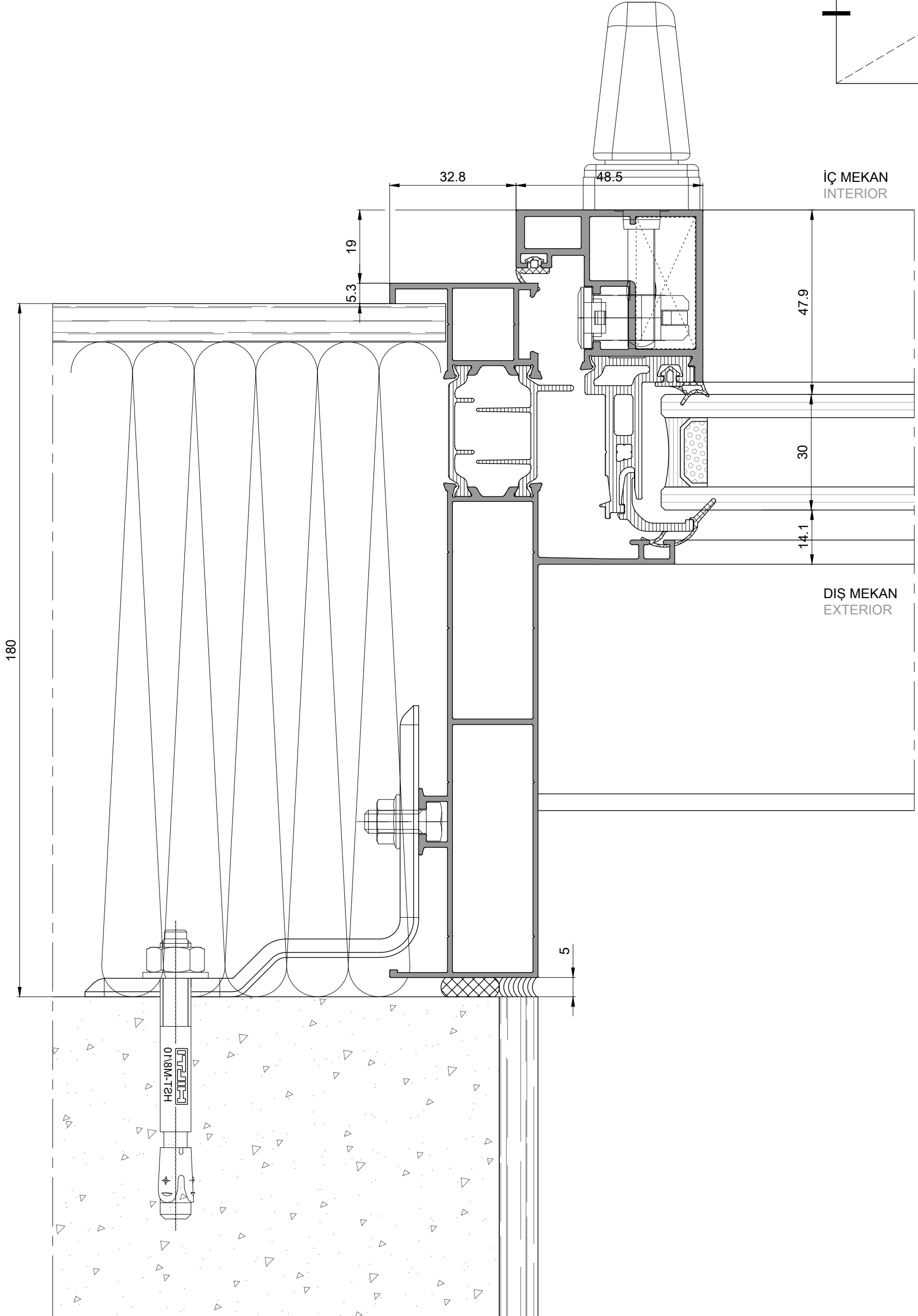

200mm YALITIMLI SOL YAN DETAY
200mm isolation with left side detail

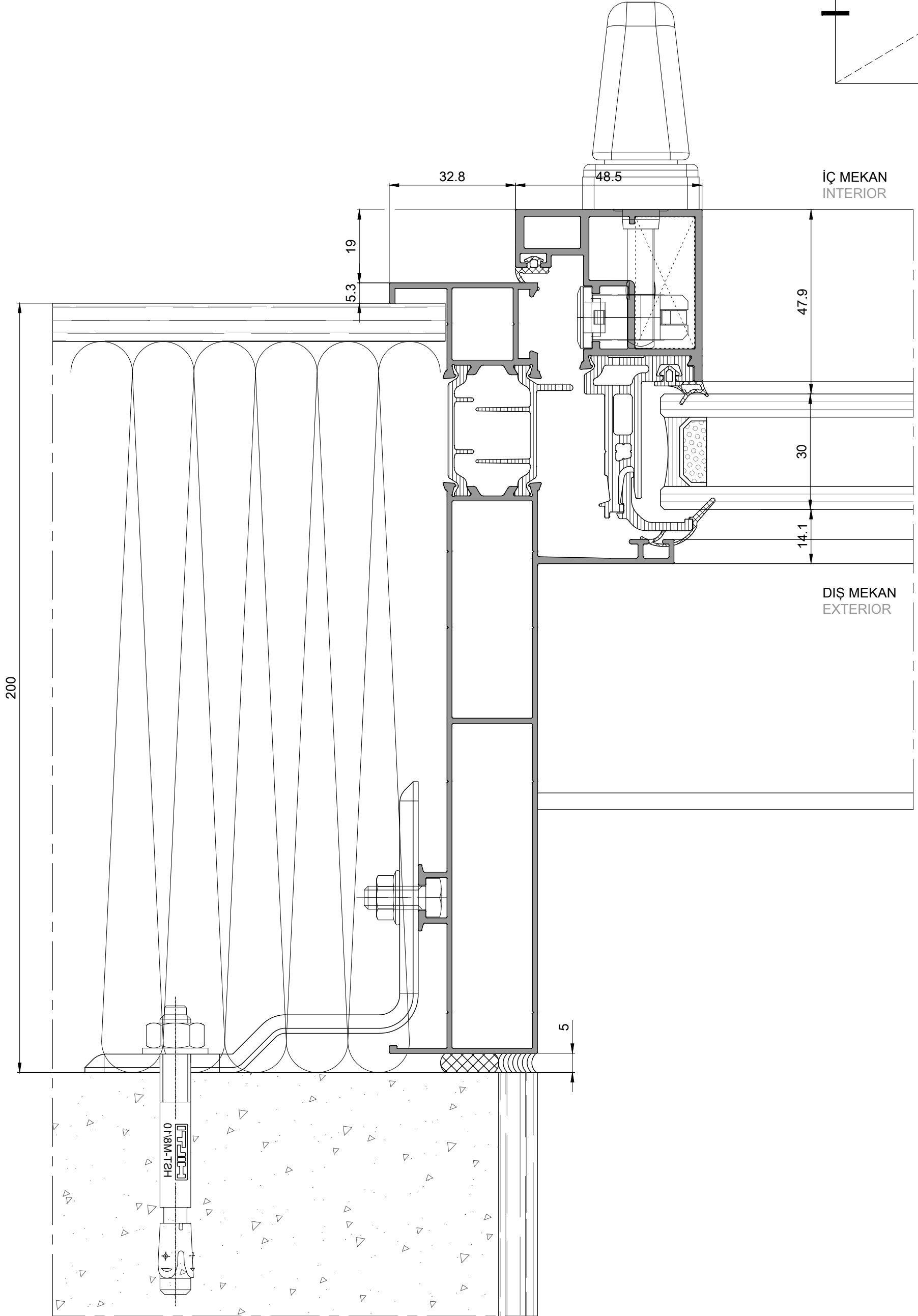
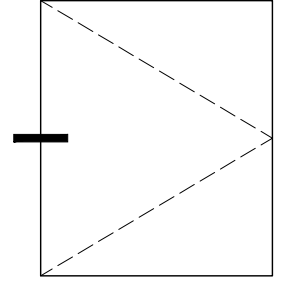

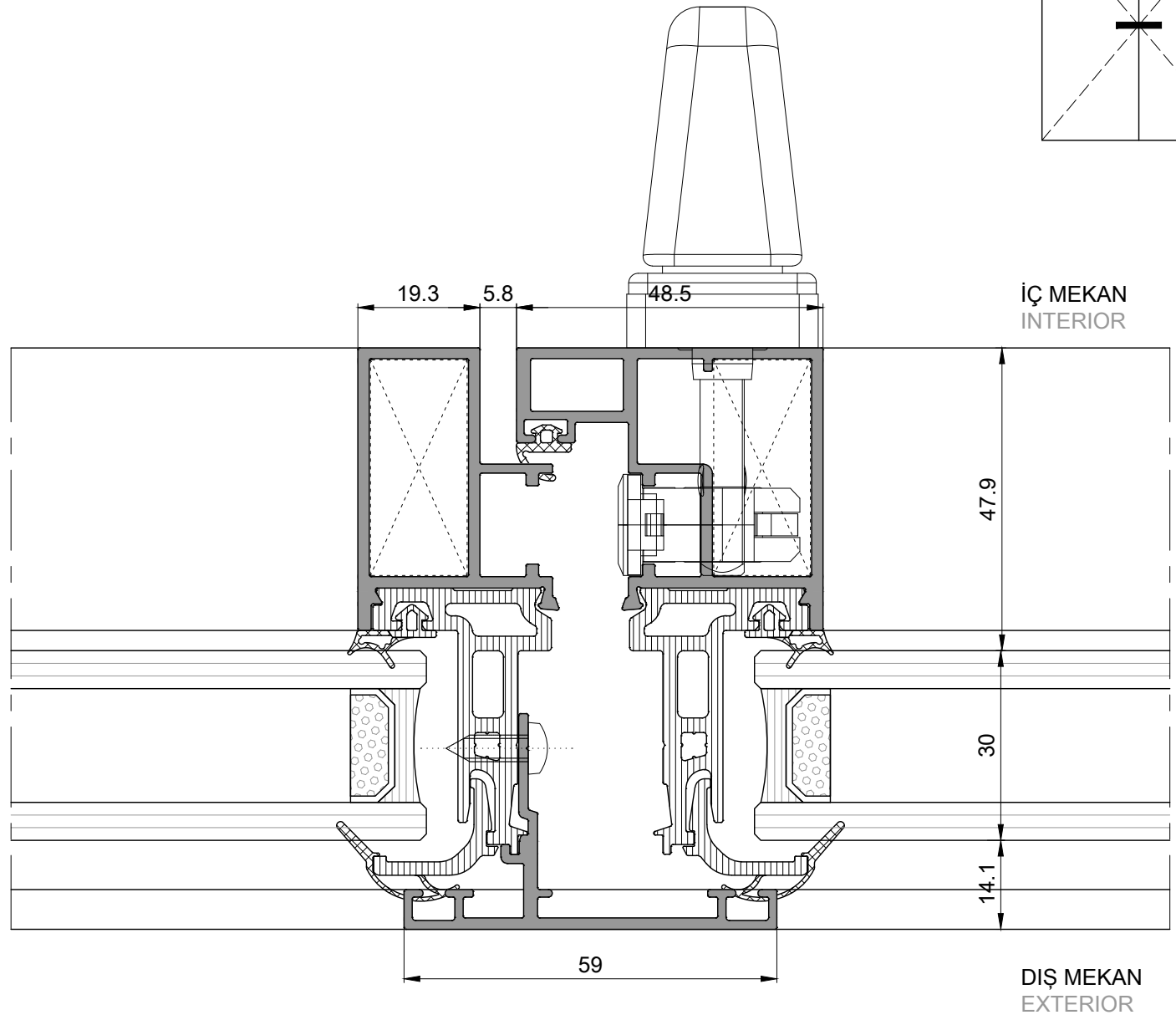
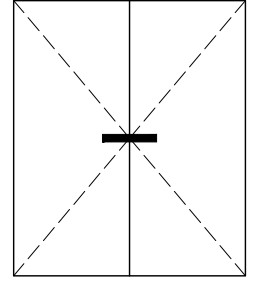

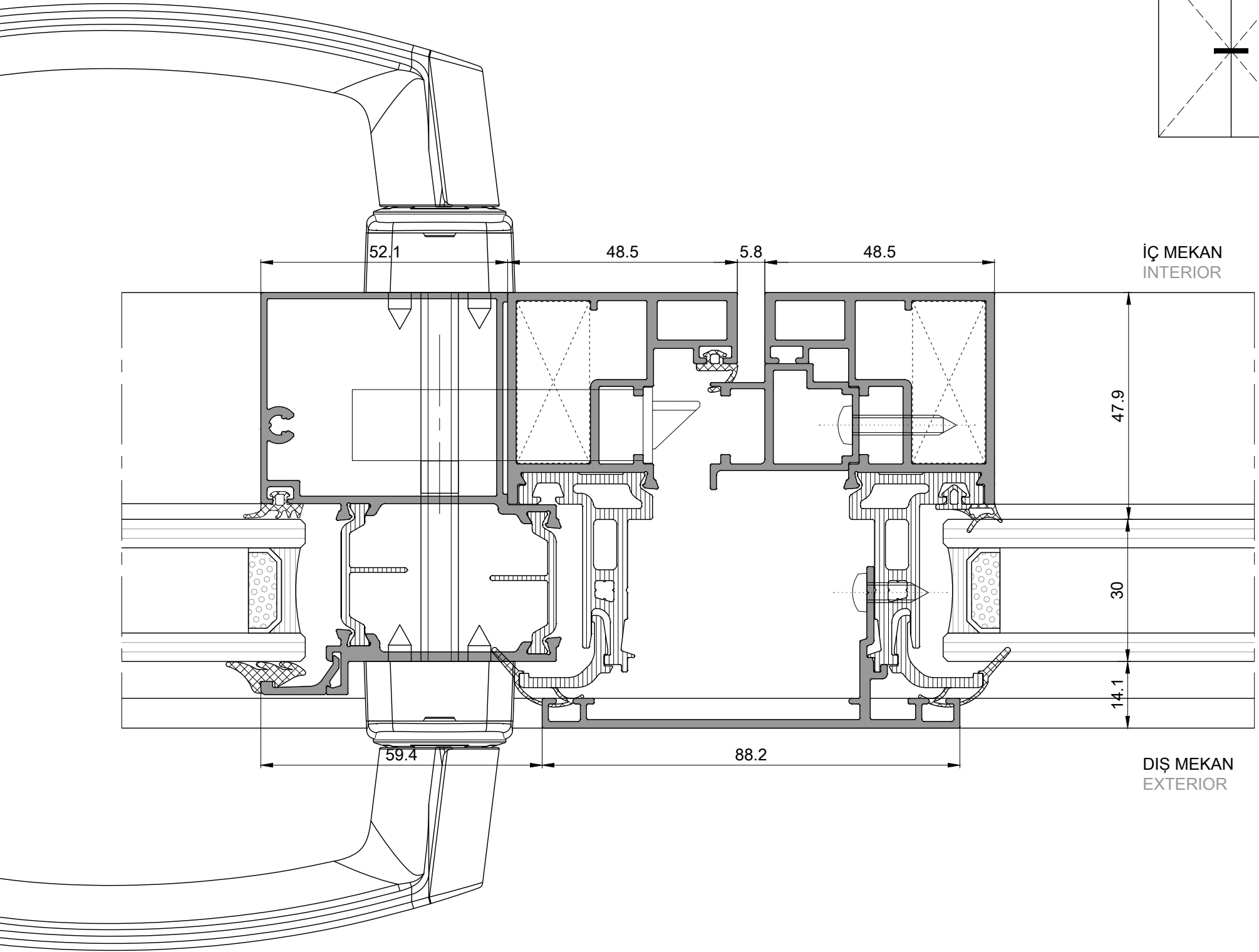
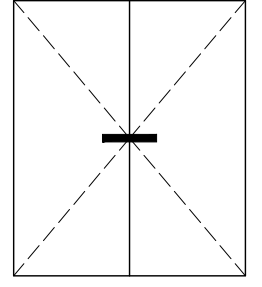

100mm YALITIMLI SAG YAN DETAY
100mm isolation with right side detail

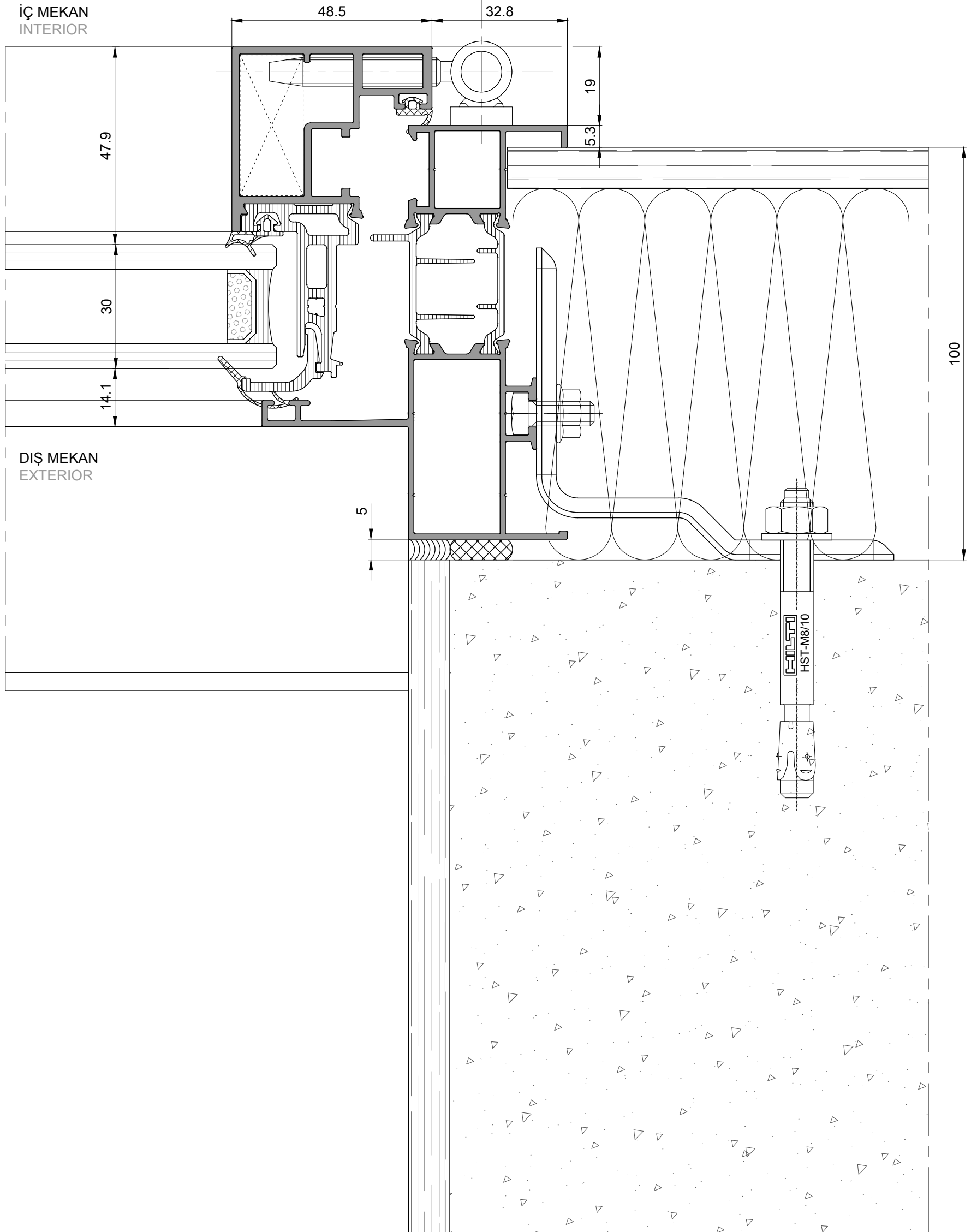
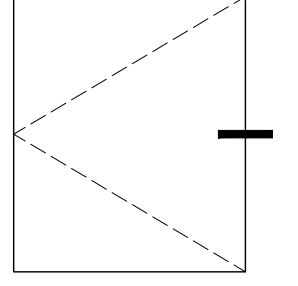

120mm YALITIMLI SAG YAN DETAY
120mm isolation with right side detail

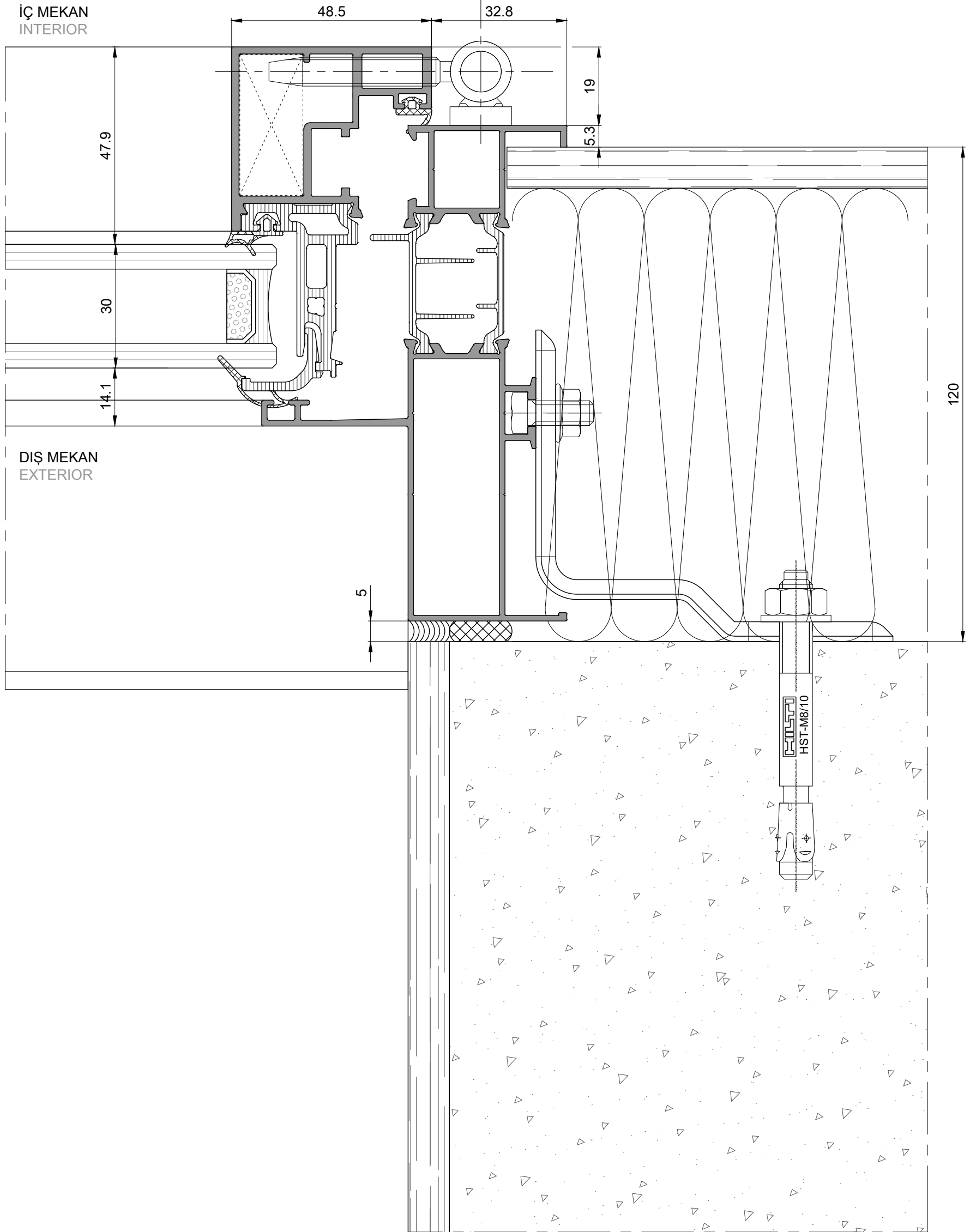
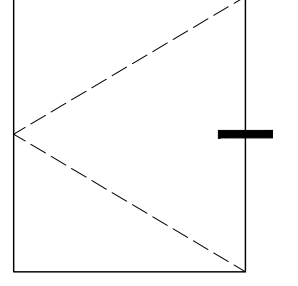

140mm YALITIMLI SAG YAN DETAY
140mm isolation with right side detail

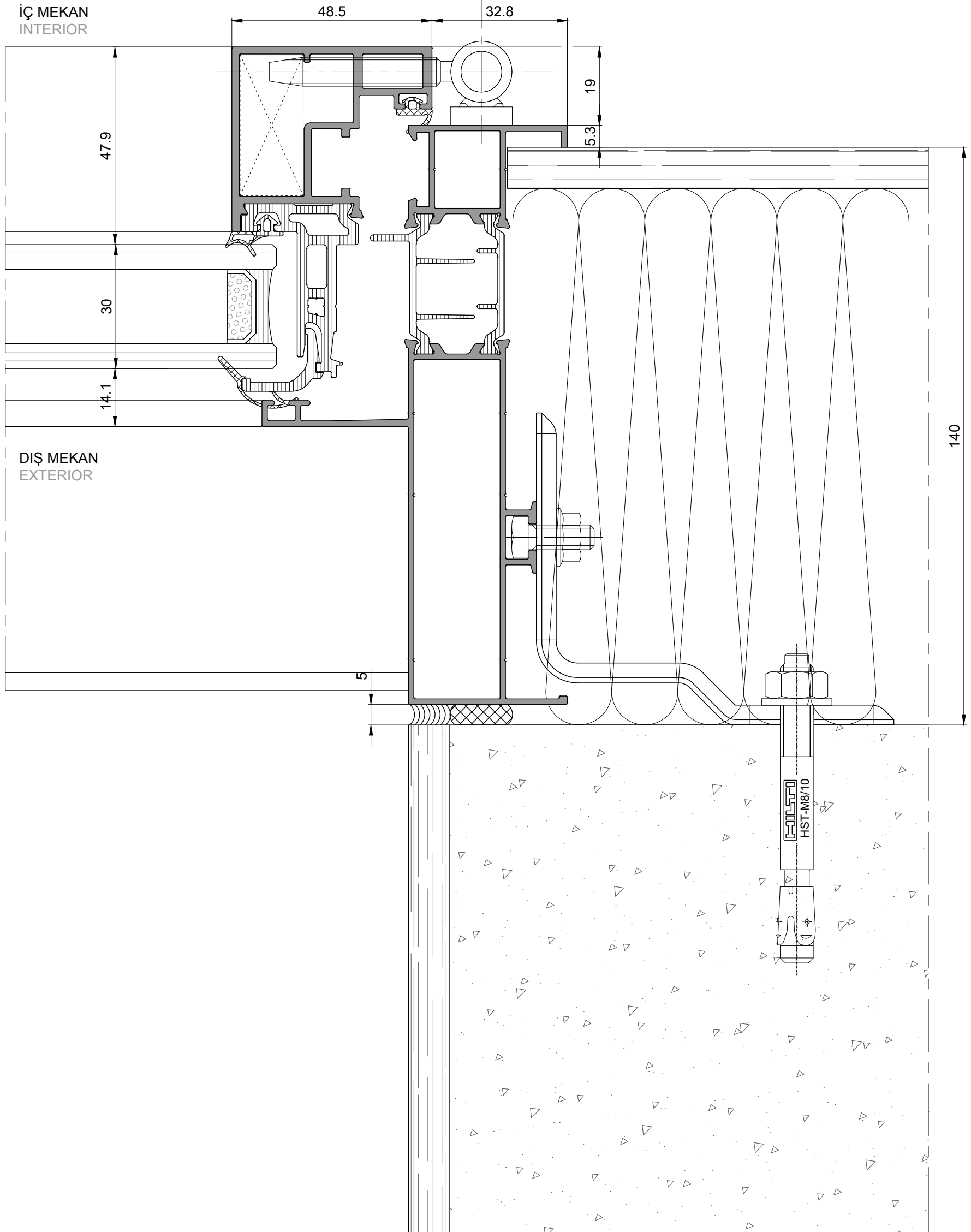
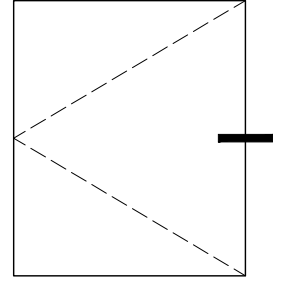

160mm YALITIMLI SAG YAN DETAY
160mm isolation with right side detail

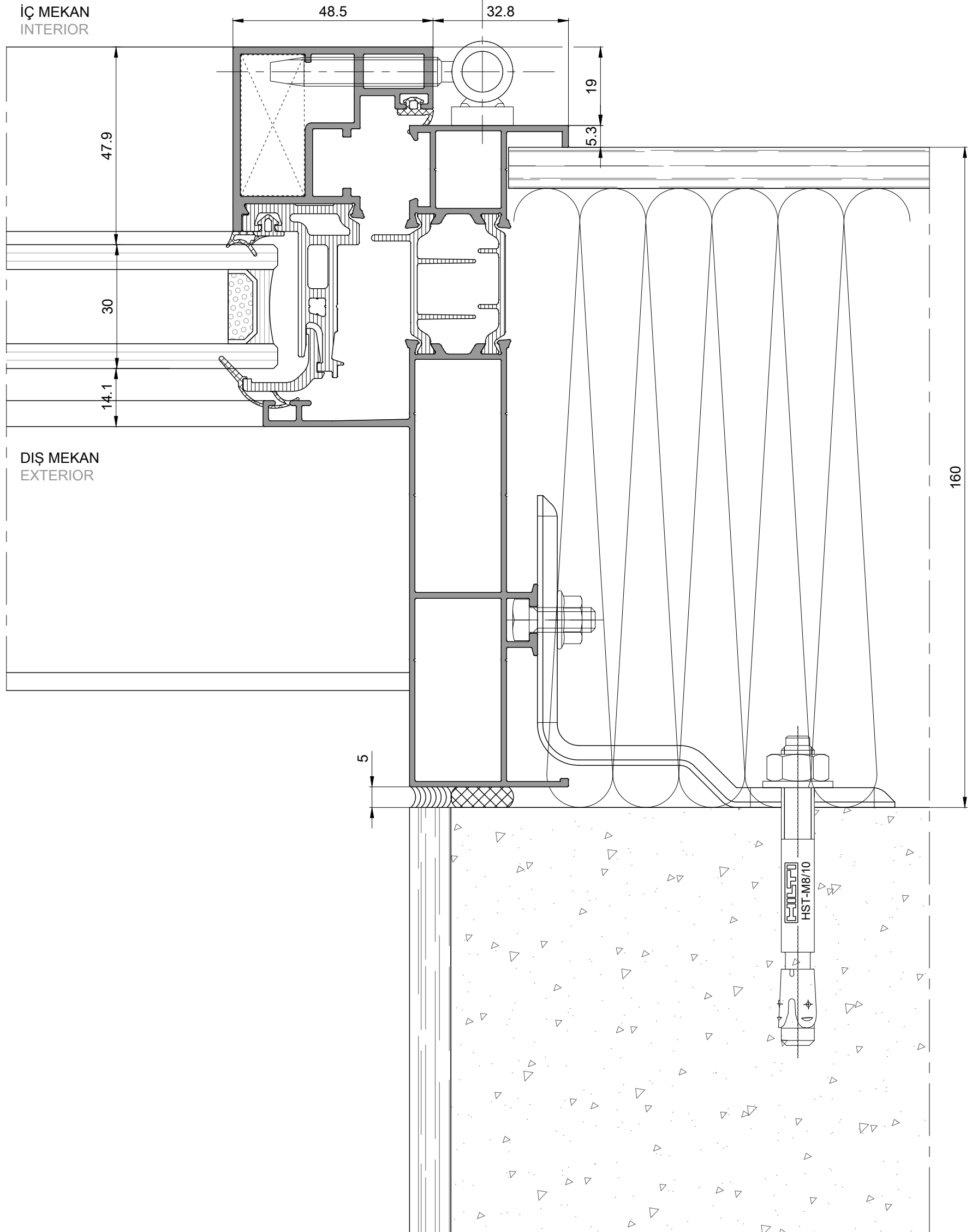
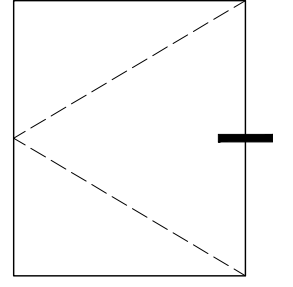

180mm YALITIMLI SAG YAN DETAY
180mm isolation with right side detail

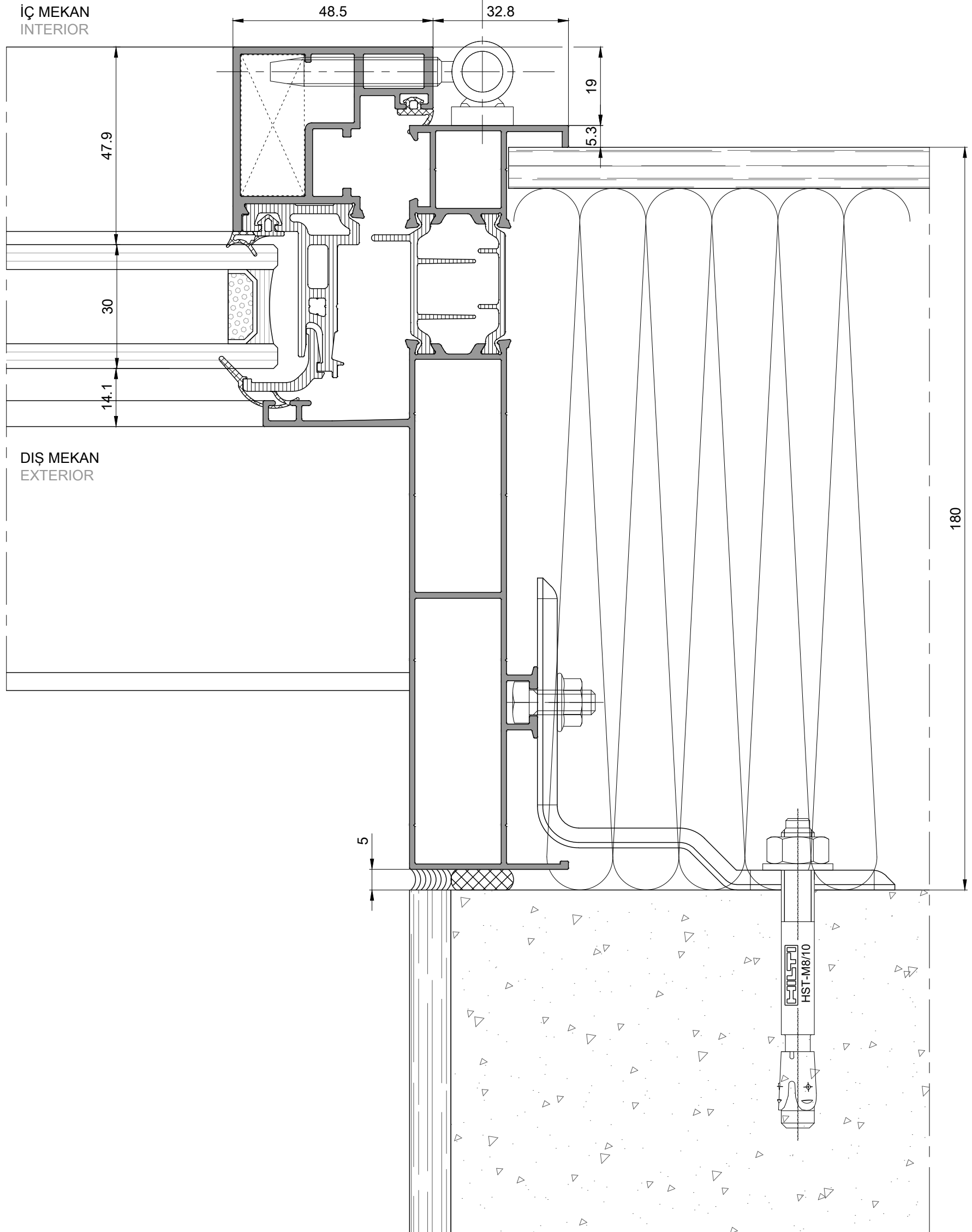
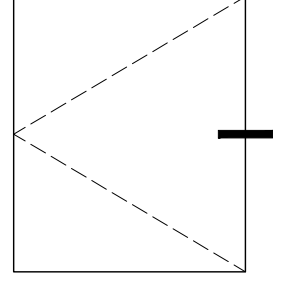

200mm YALITIMLI SAG YAN DETAY
200mm isolation with right side detail

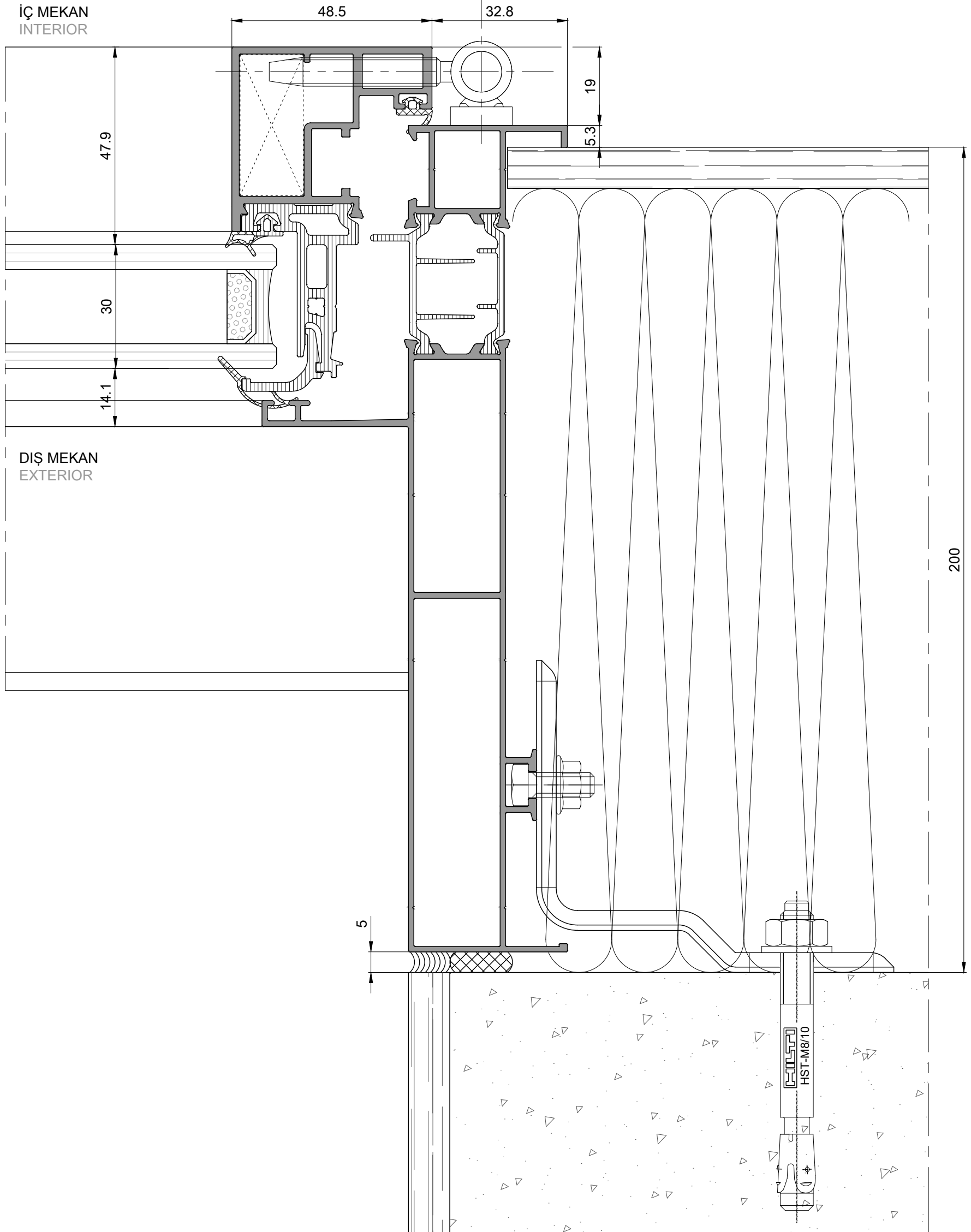
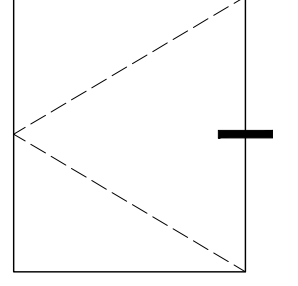

100mm YALITIMLI ÜST DETAY
100mm isolation with top side detail

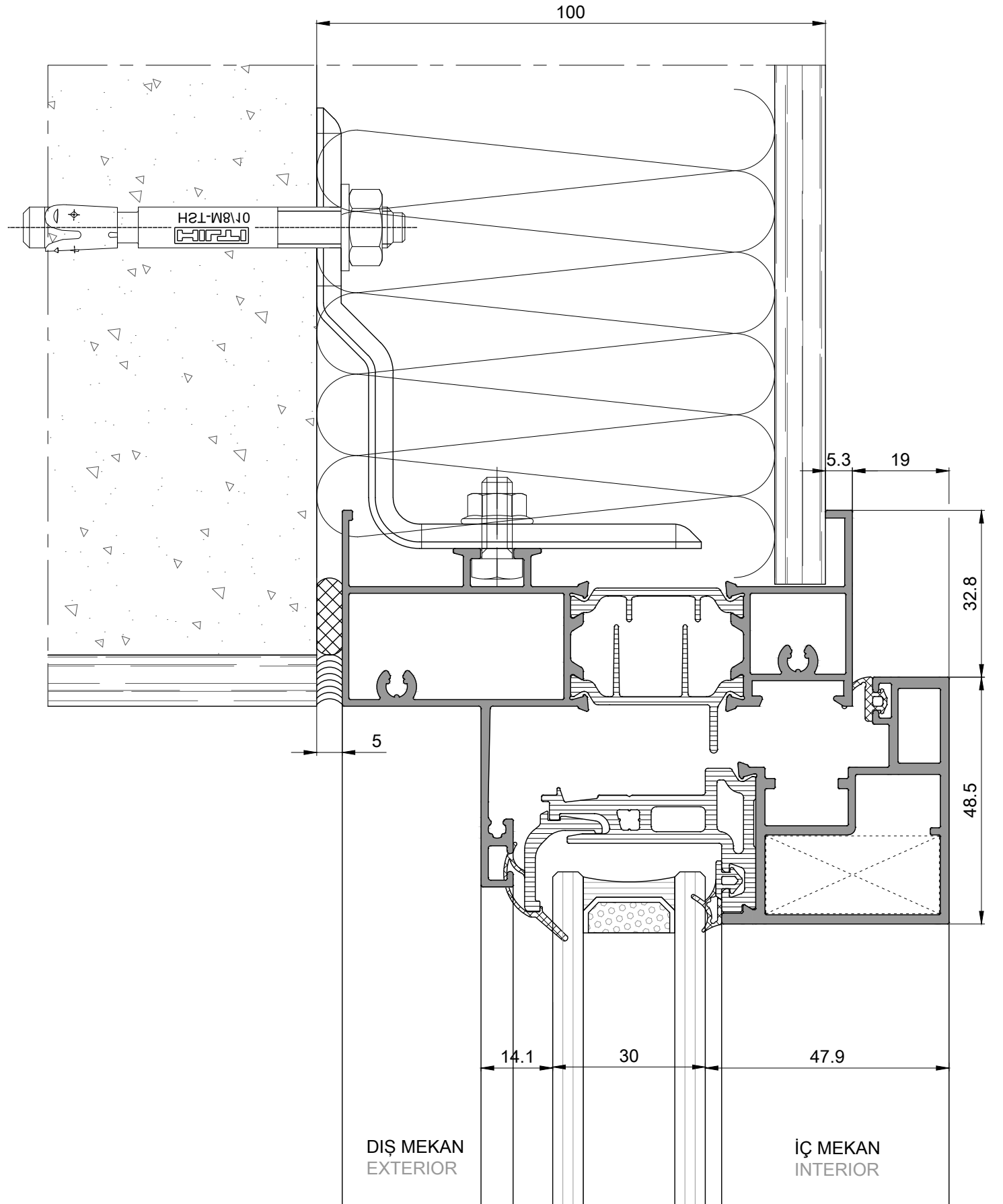
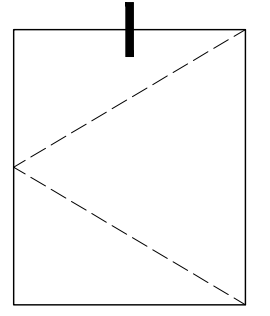

120mm YALITIMLI ÜST DETAY
120mm isolation with top side detail

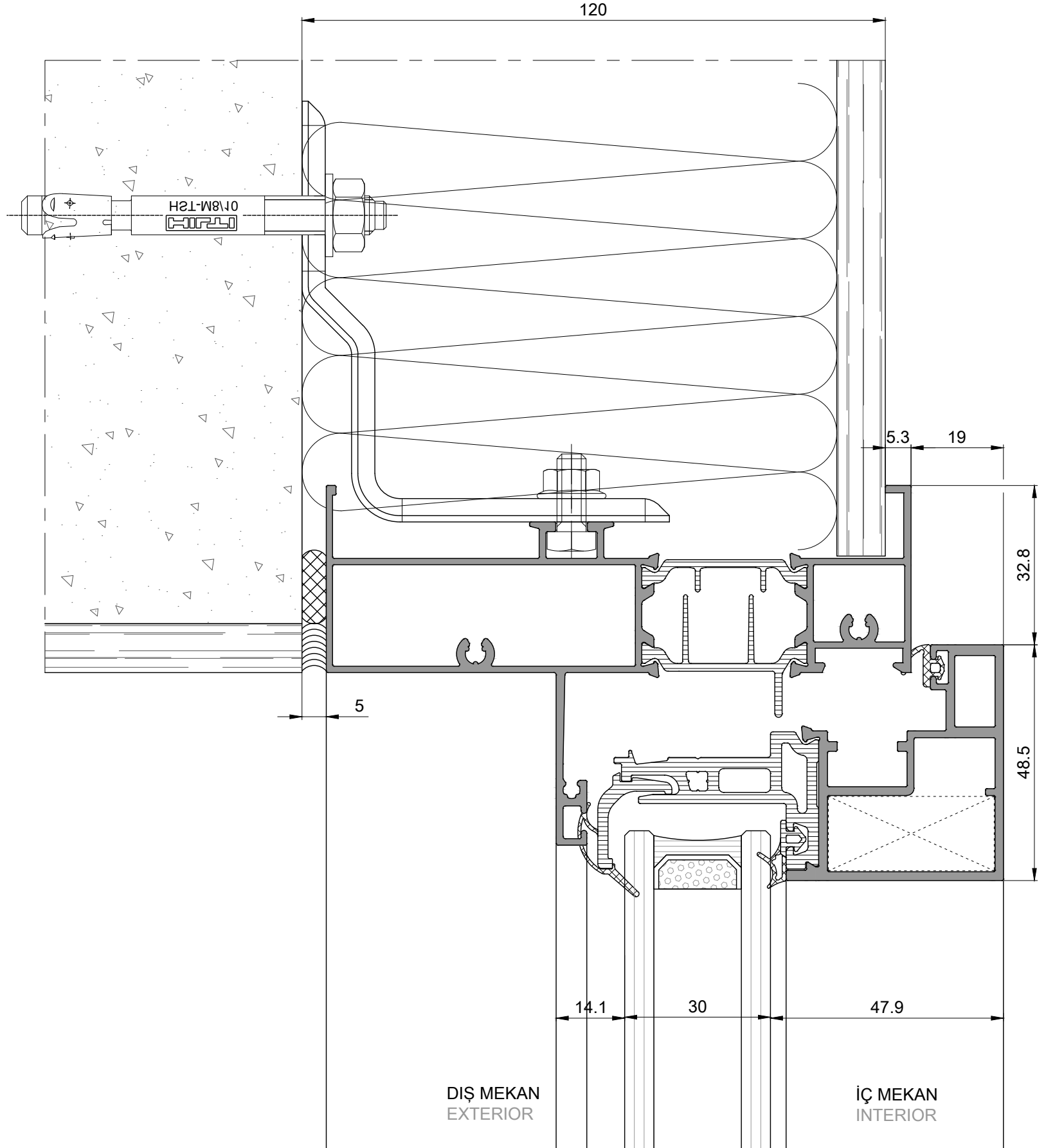
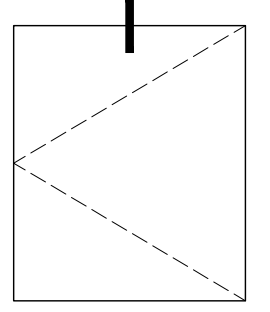

140mm YALITIMLI ÜST DETAY
140mm isolation with top side detail

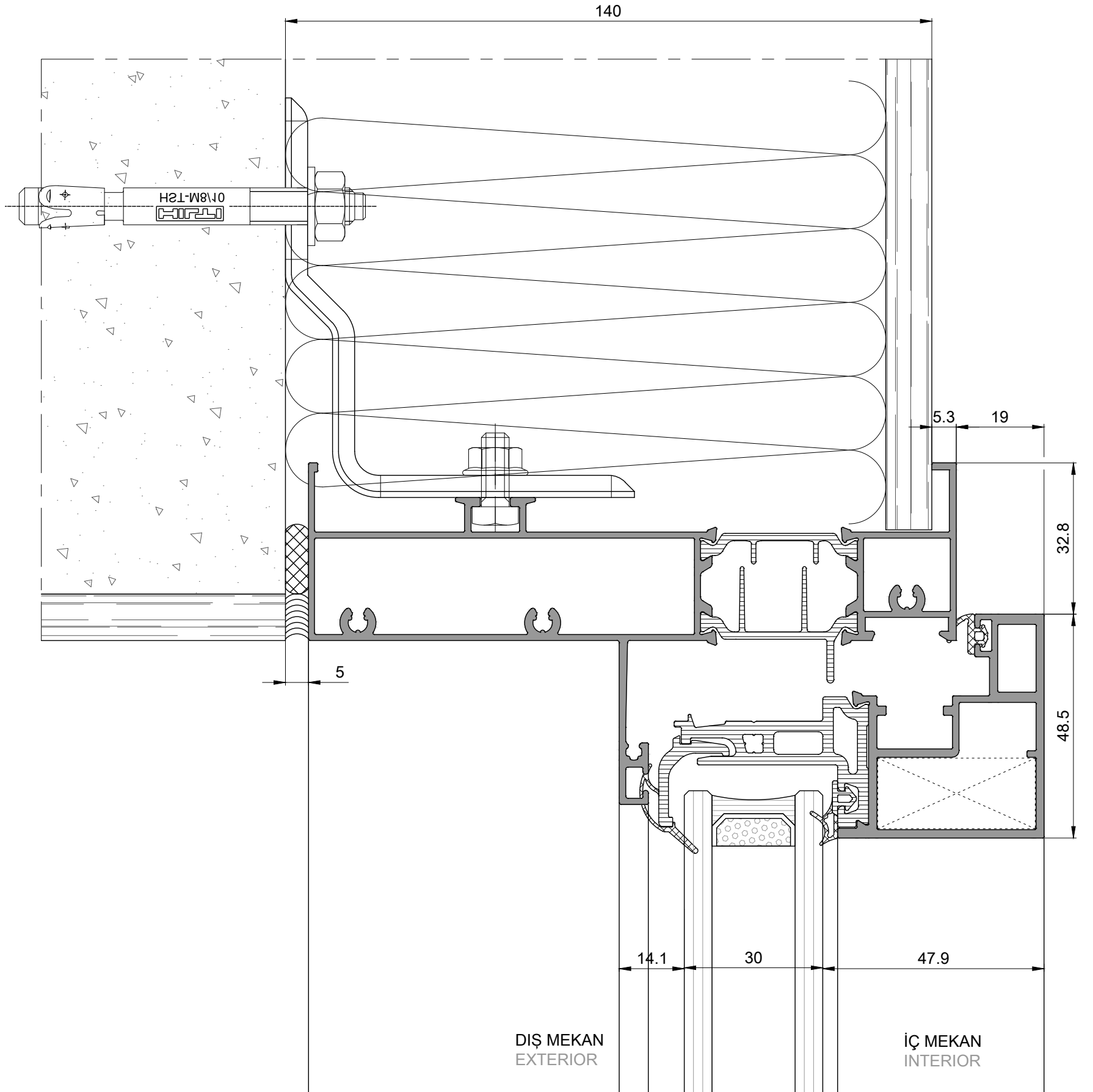
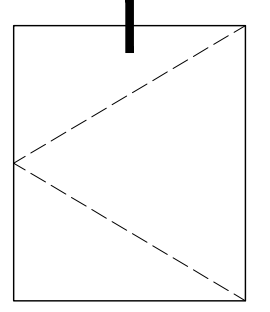

160mm YALITIMLI ÜST DETAY
160mm isolation with top side detail

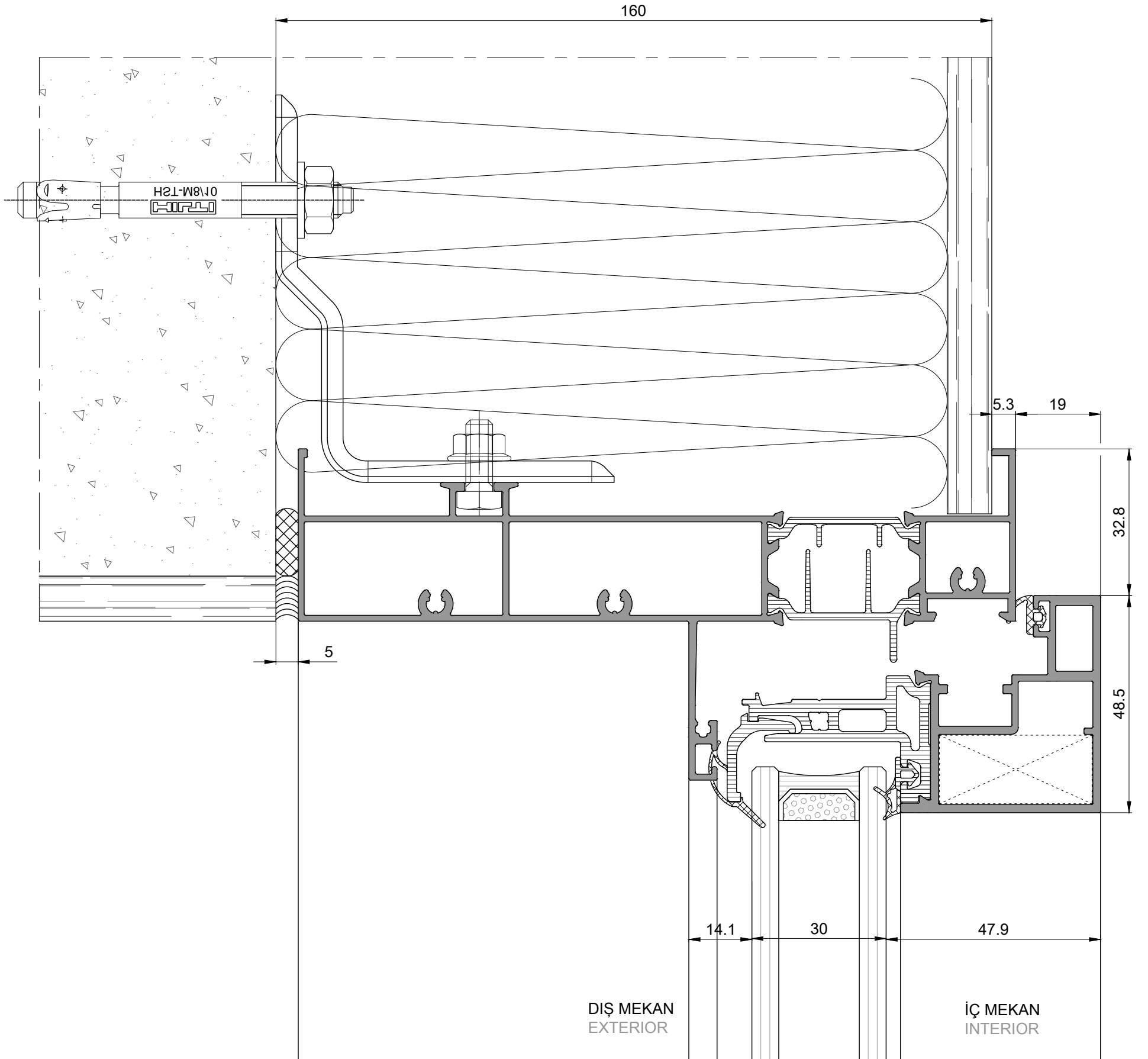
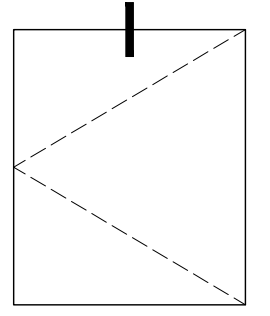

180mm YALITIMLI ÜST DETAY
180mm isolation with top side detail

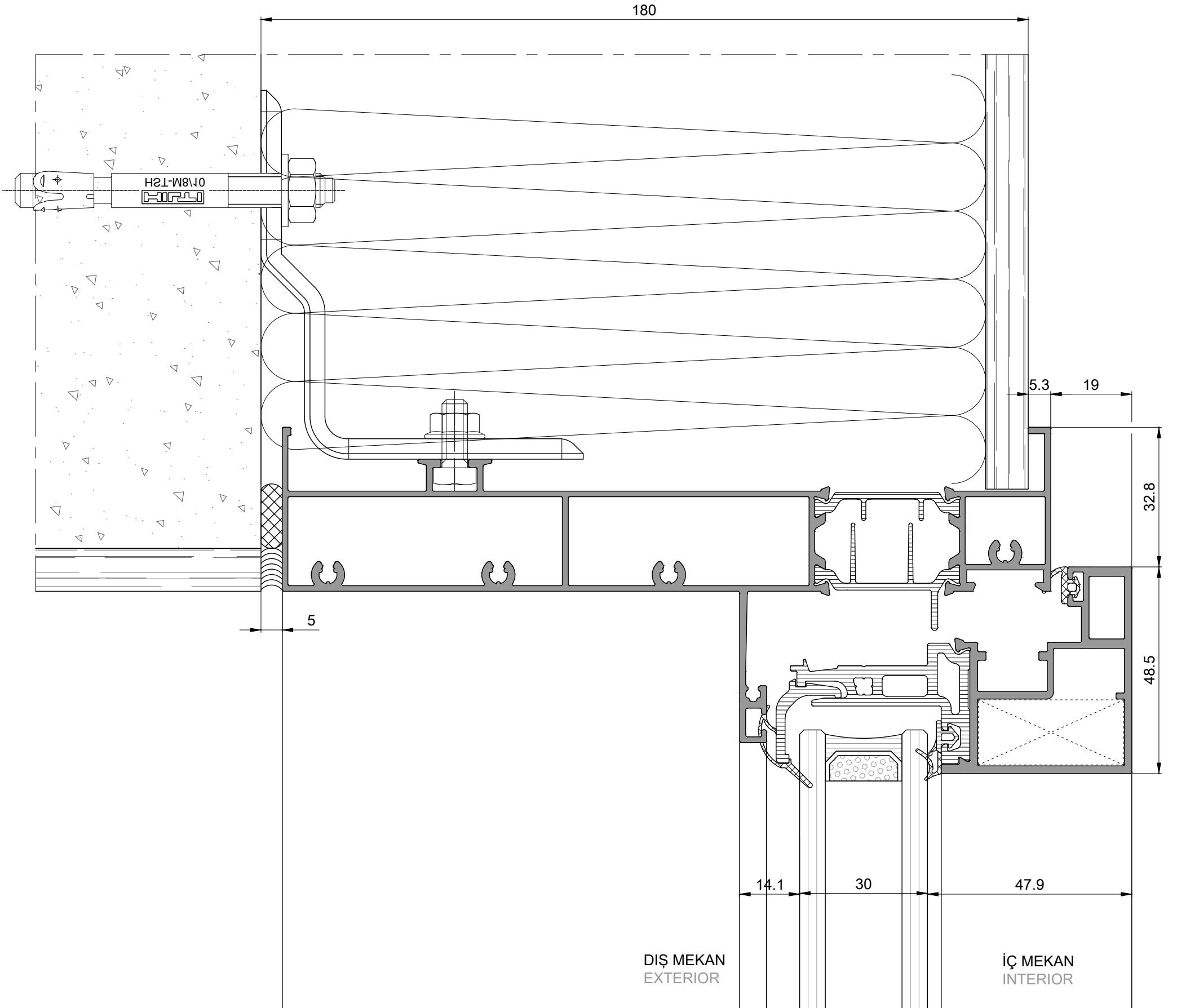
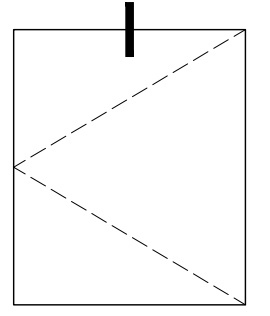

200mm YALITIMLI ÜST DETAY
200mm isolation with top side detail

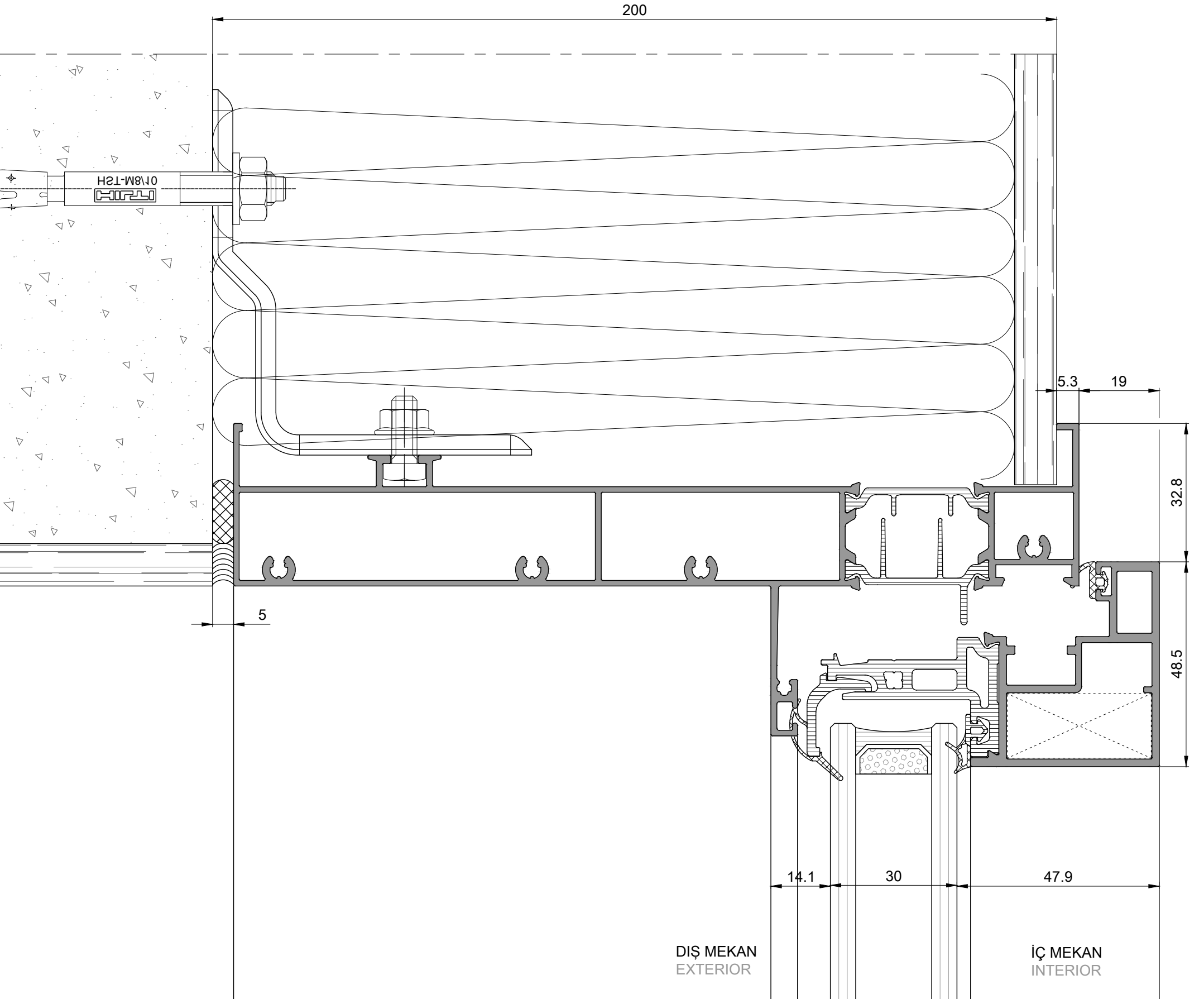
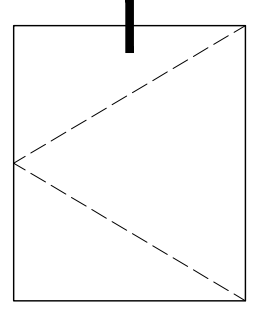

100-120-140mm YALITIMLI ALT DETAY
100-120-140mm isolation with bottom side detail

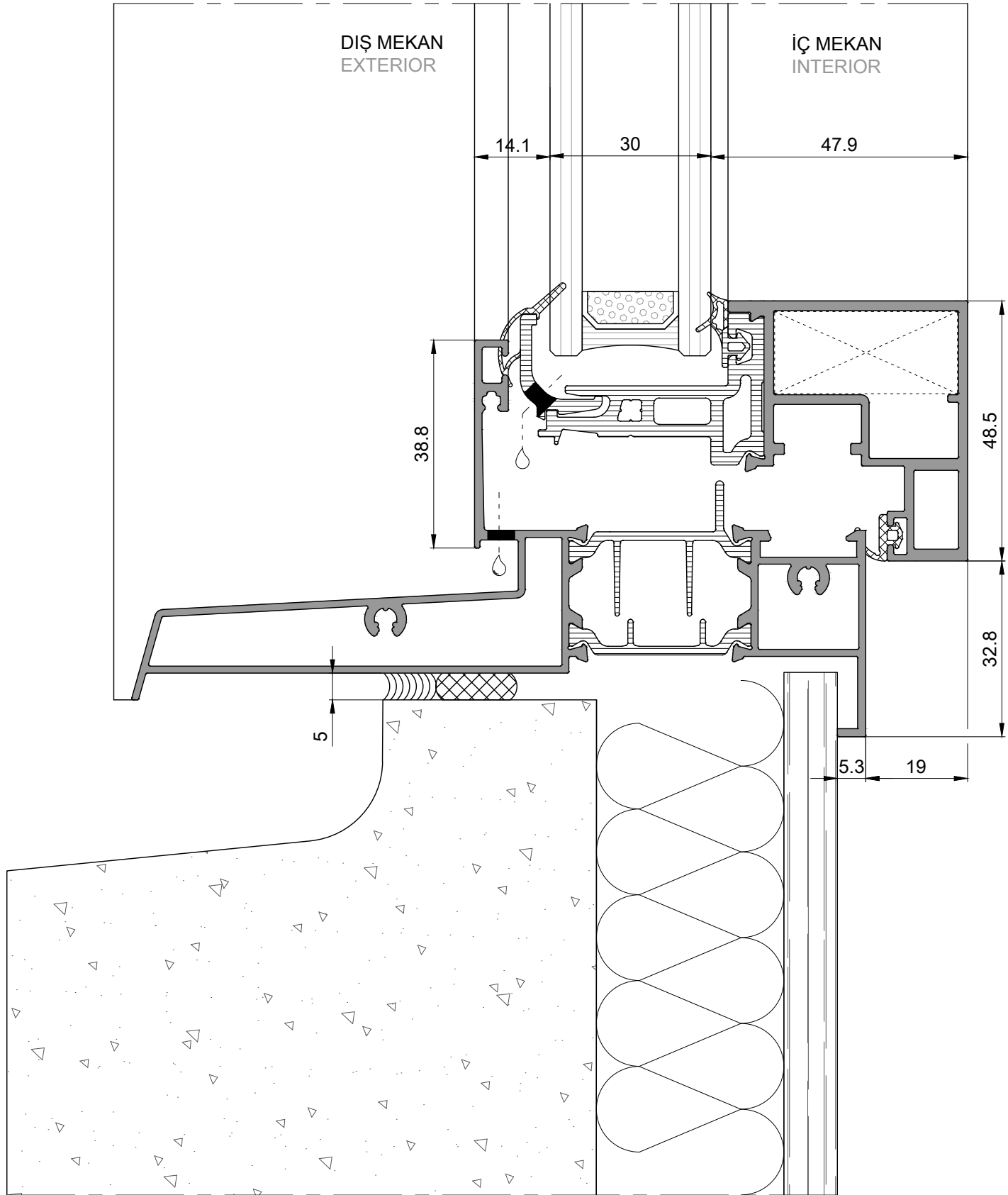
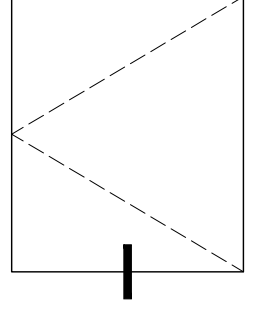

160-180-200mm YALITIMLI ALT DETAY
160-180-200mm isolation with bottom side detail

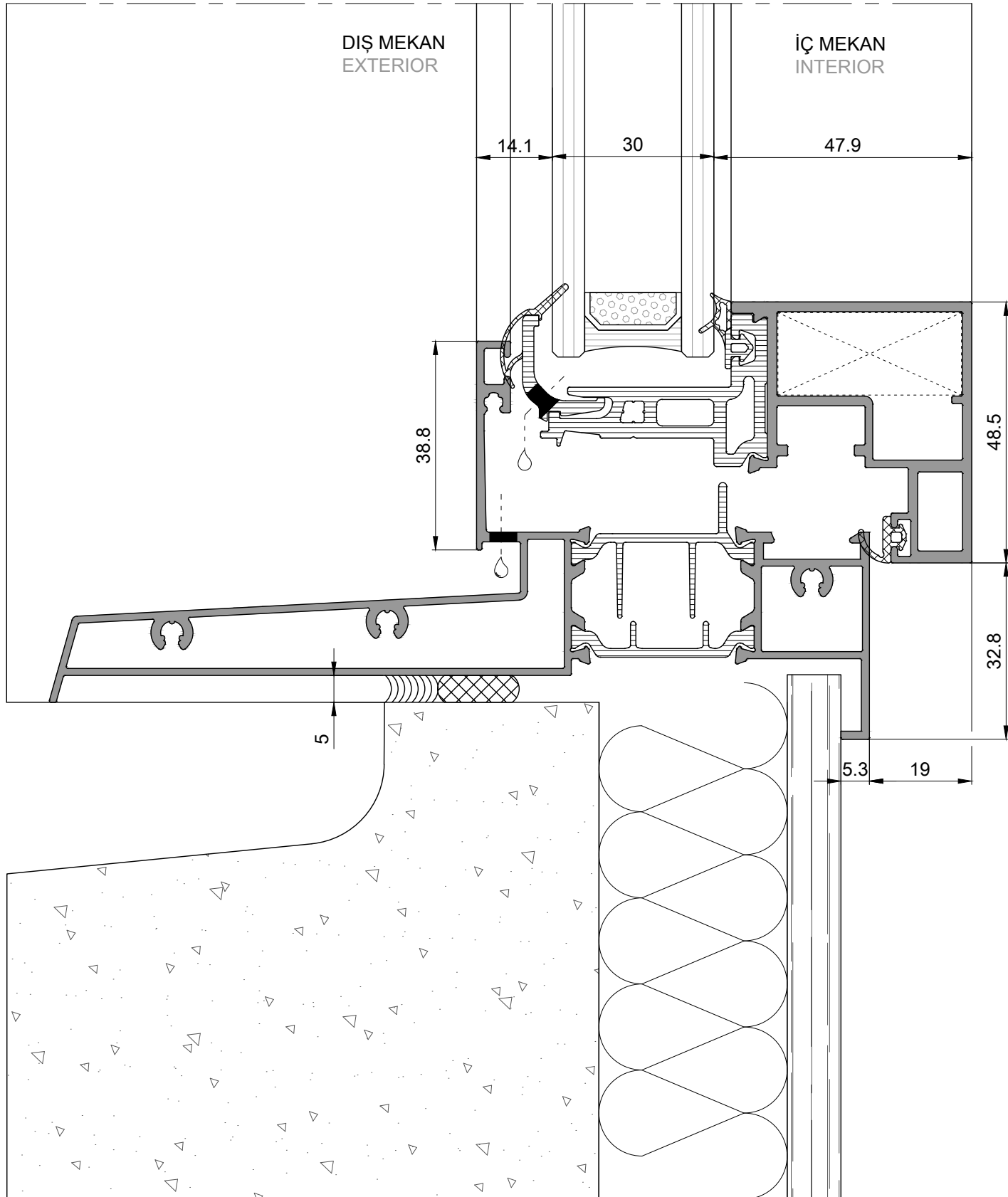
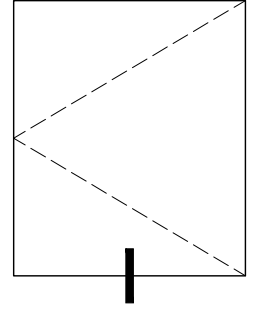

KAPI ALT EŞİK DETAY
Door bottom side threshold detail

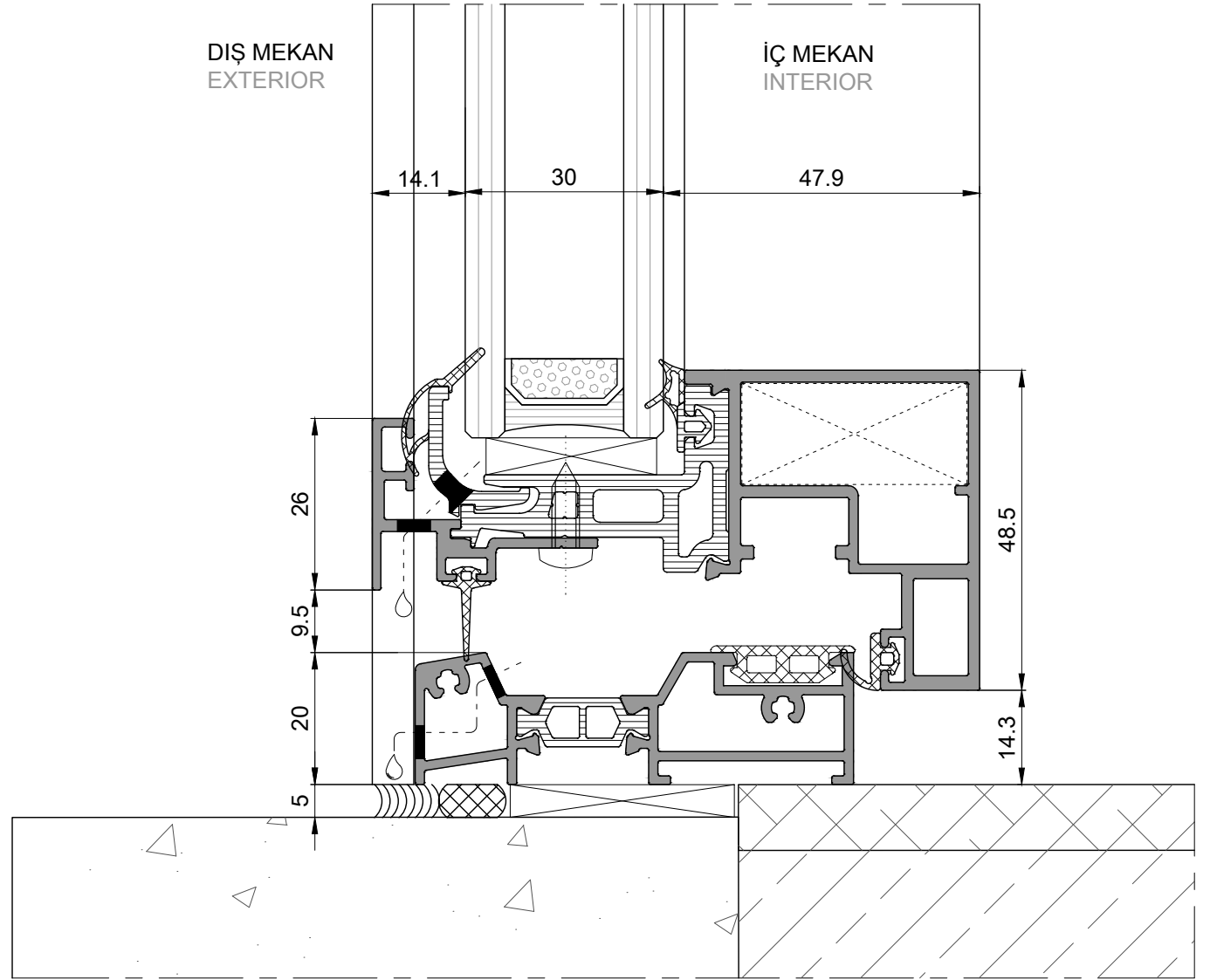
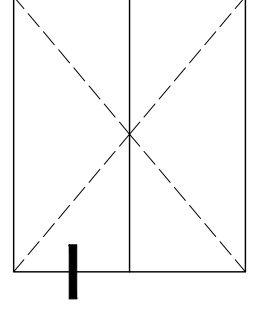

ALFA

GİZLİ KANATLI PENCERE ve KAPI SİSTEMİ CONCEALED SASH WINDOW and DOOR SYSTEM

GİZLİ KANATLI ve SABİT BÖLÜMLÜ PENCERE PRENSİP SİSTEM DETAYLARI PRINCIPAL SECTIONS for CONCEALED SASH with FIXED GLASS WINDOW SYSTEM

100mm YALITIMLI SOL YAN DETAY
100mm isolation with left side detail

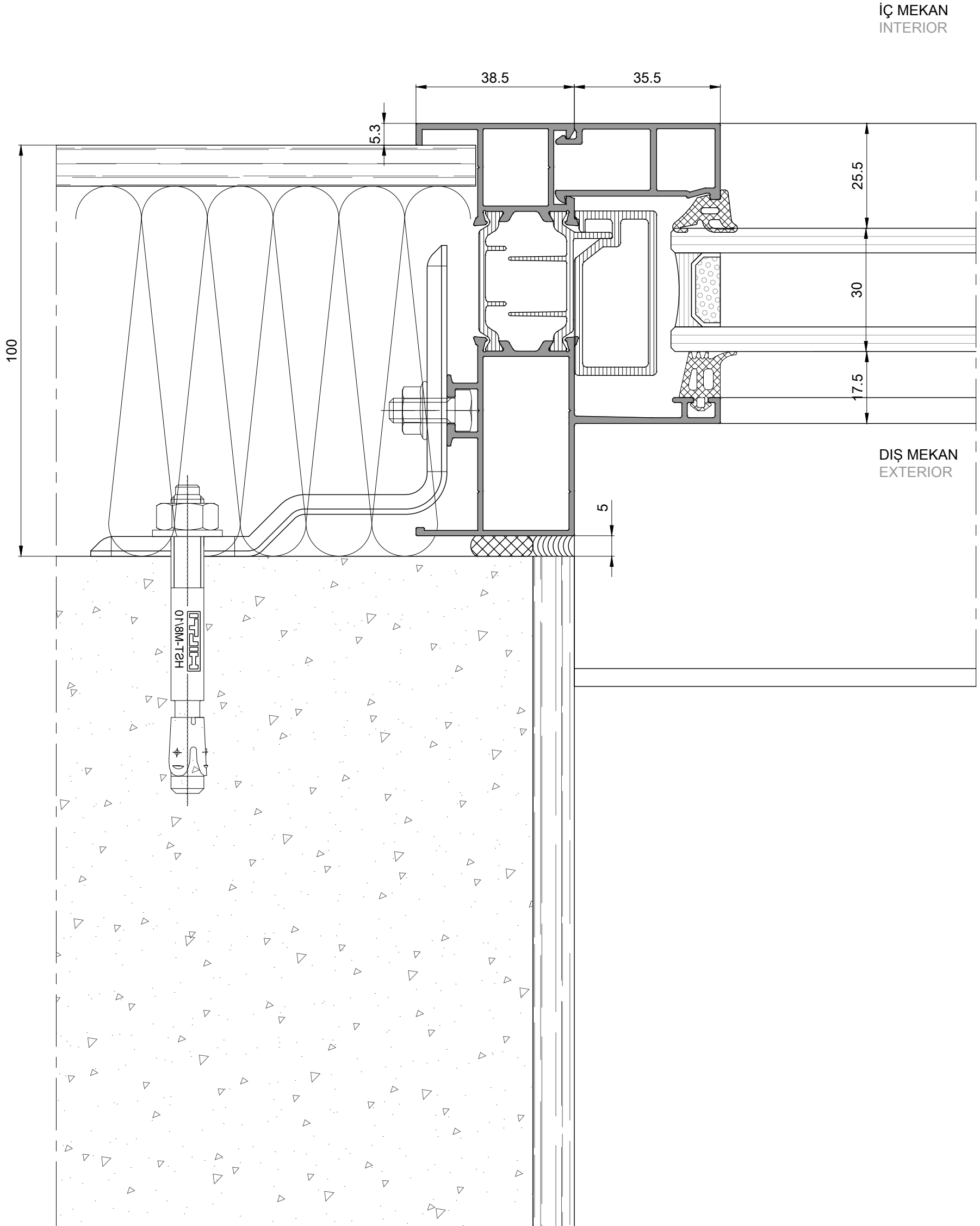
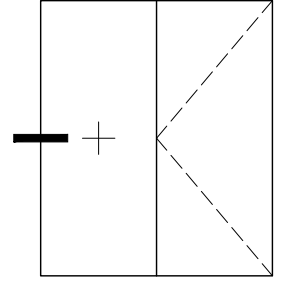

120mm YALITIMLI SOL YAN DETAY
120mm isolation with left side detail

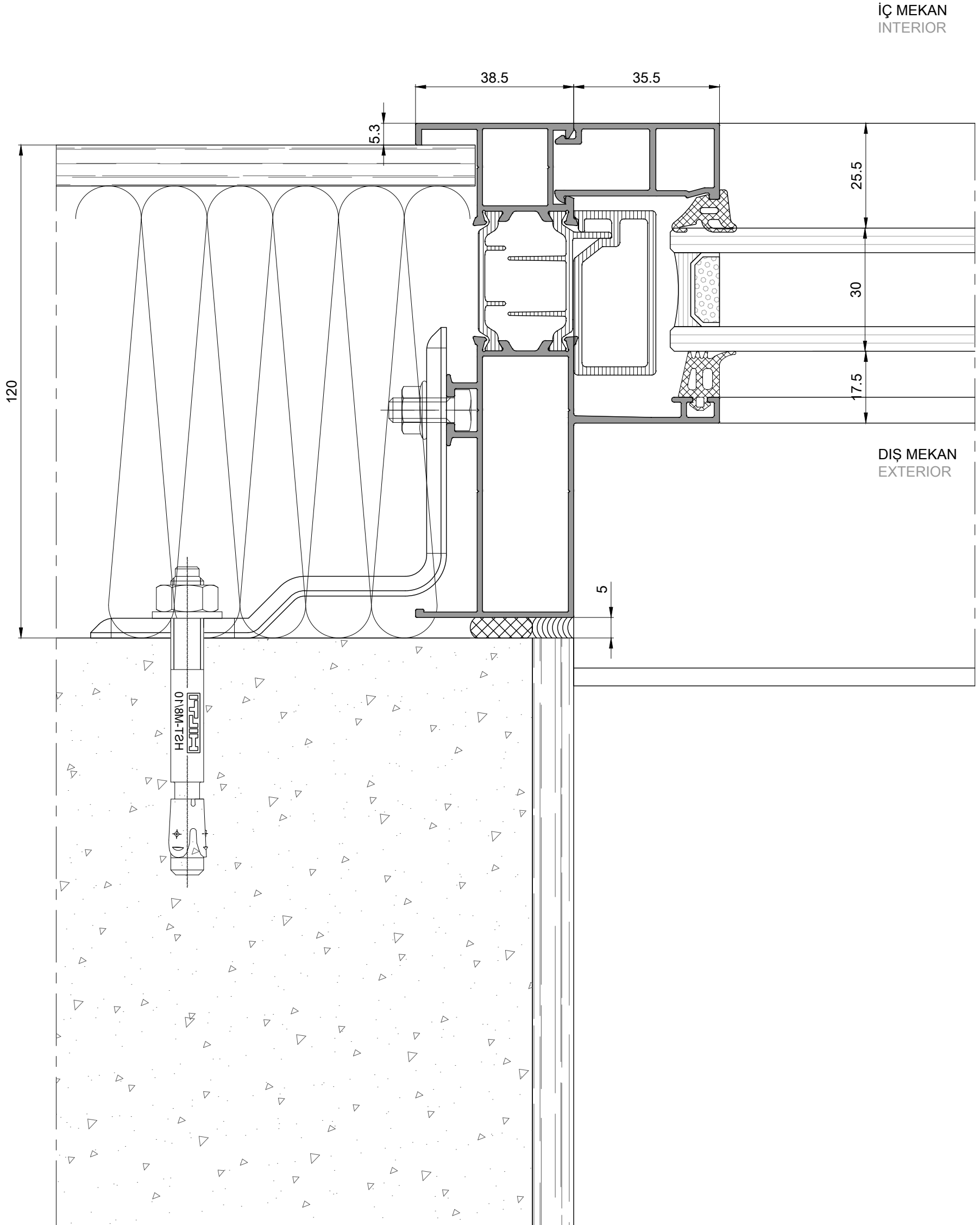
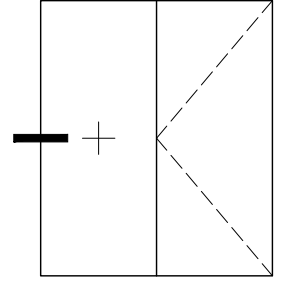

140mm YALITIMLI SOL YAN DETAY
140mm isolation with left side detail

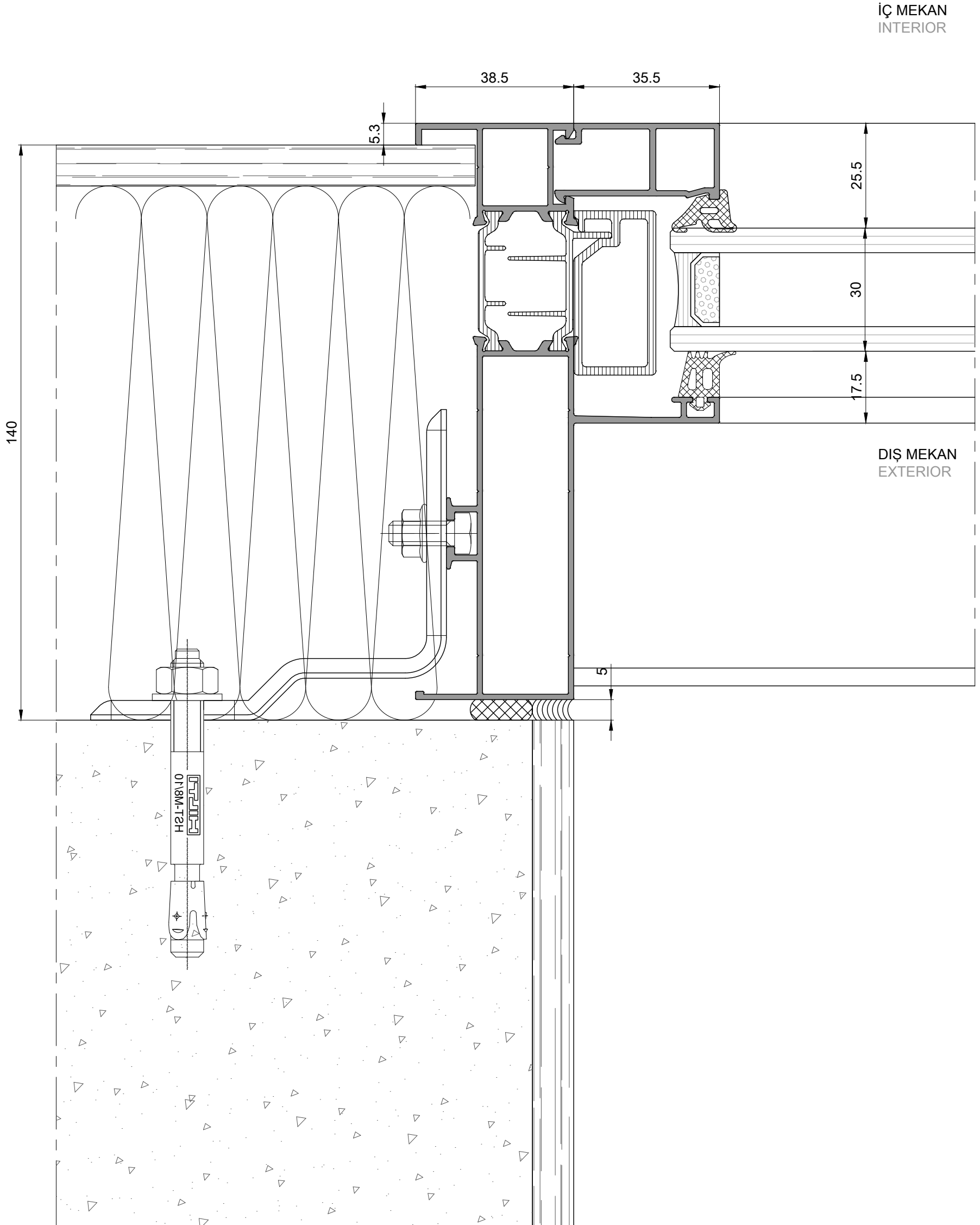
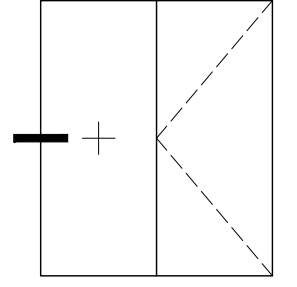

160mm YALITIMLI SOL YAN DETAY
160mm isolation with left side detail

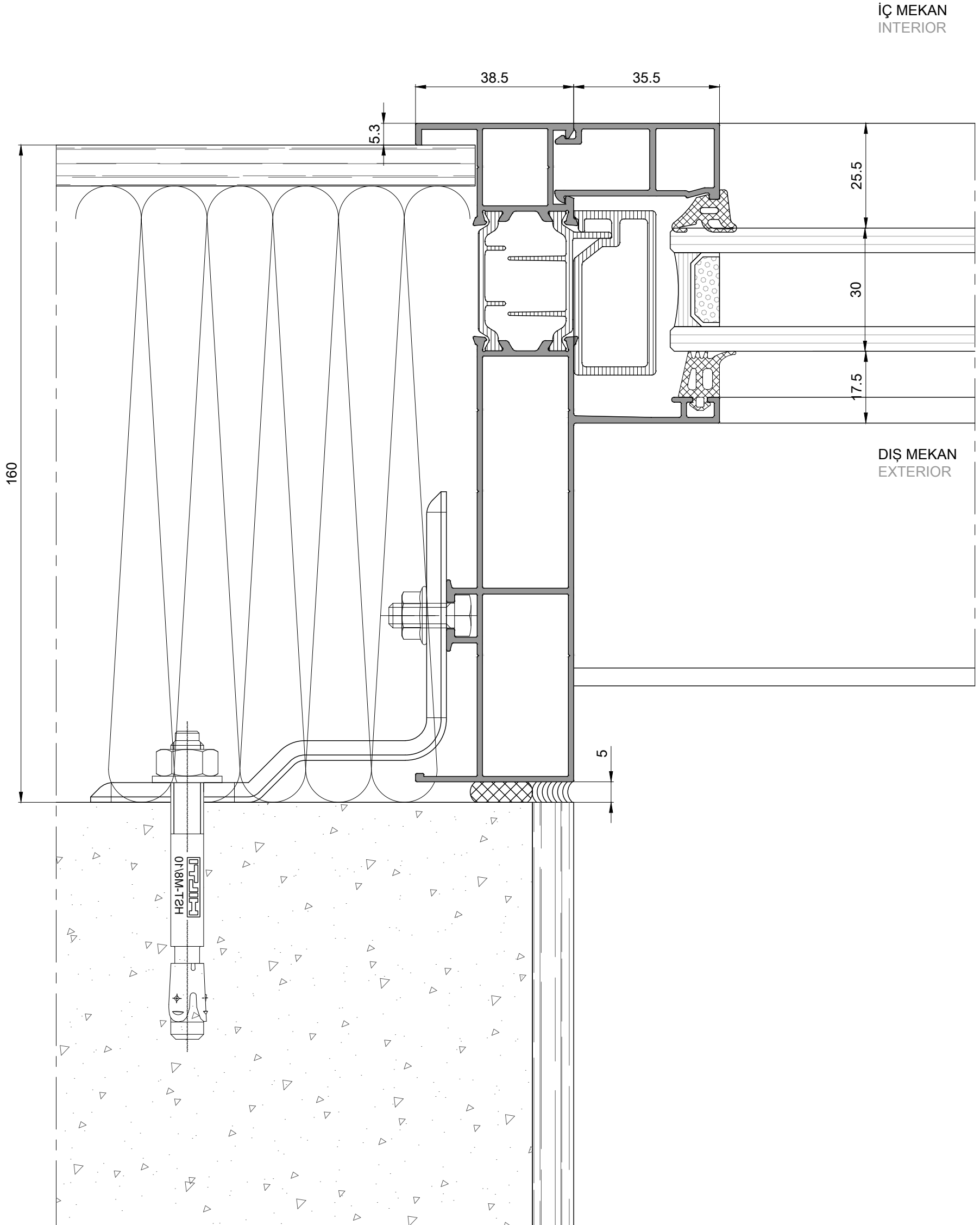
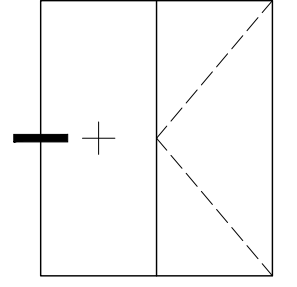

180mm YALITIMLI SOL YAN DETAY
180mm isolation with left side detail

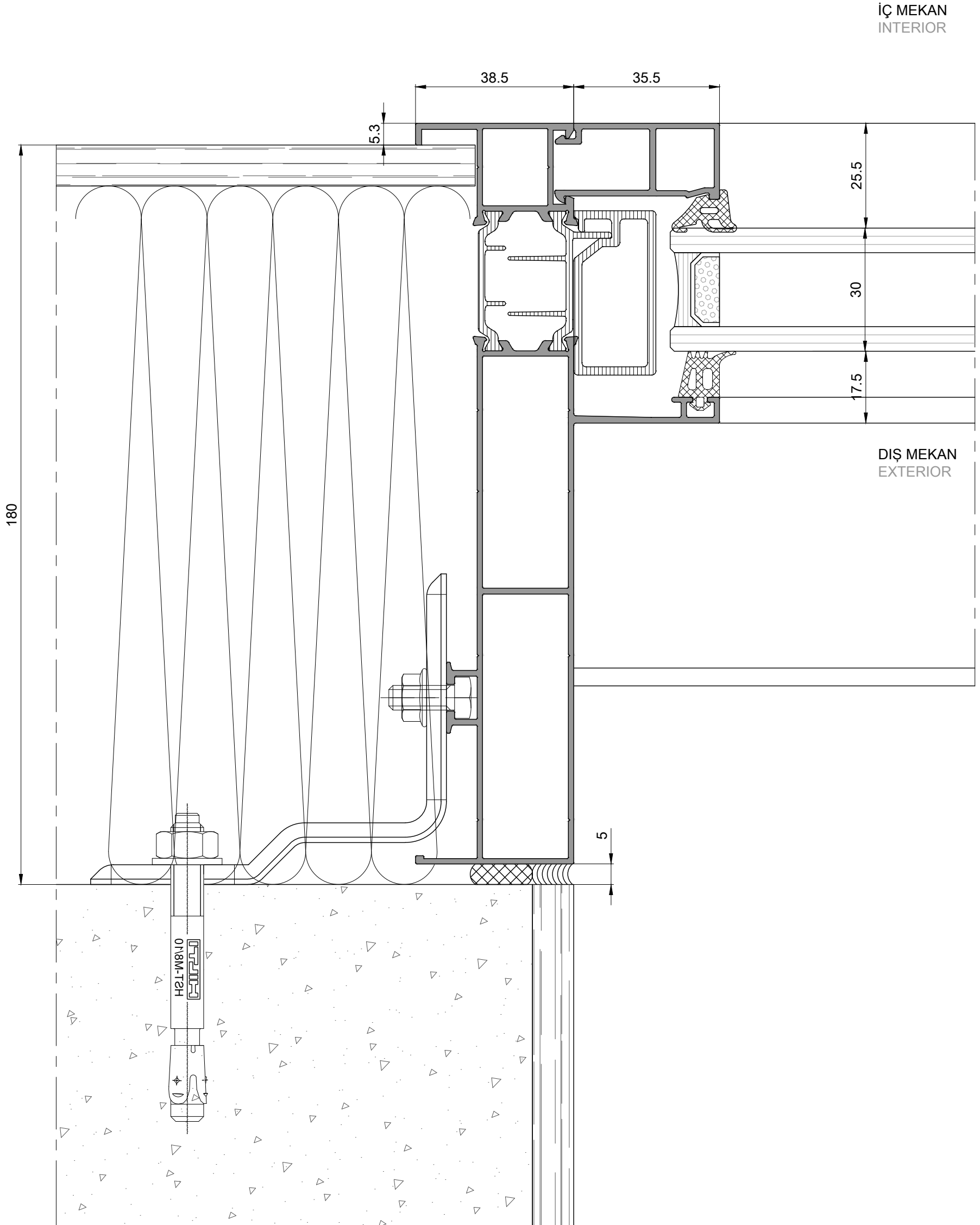
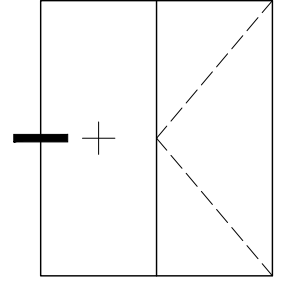

200mm YALITIMLI SOL YAN DETAY
200mm isolation with left side detail

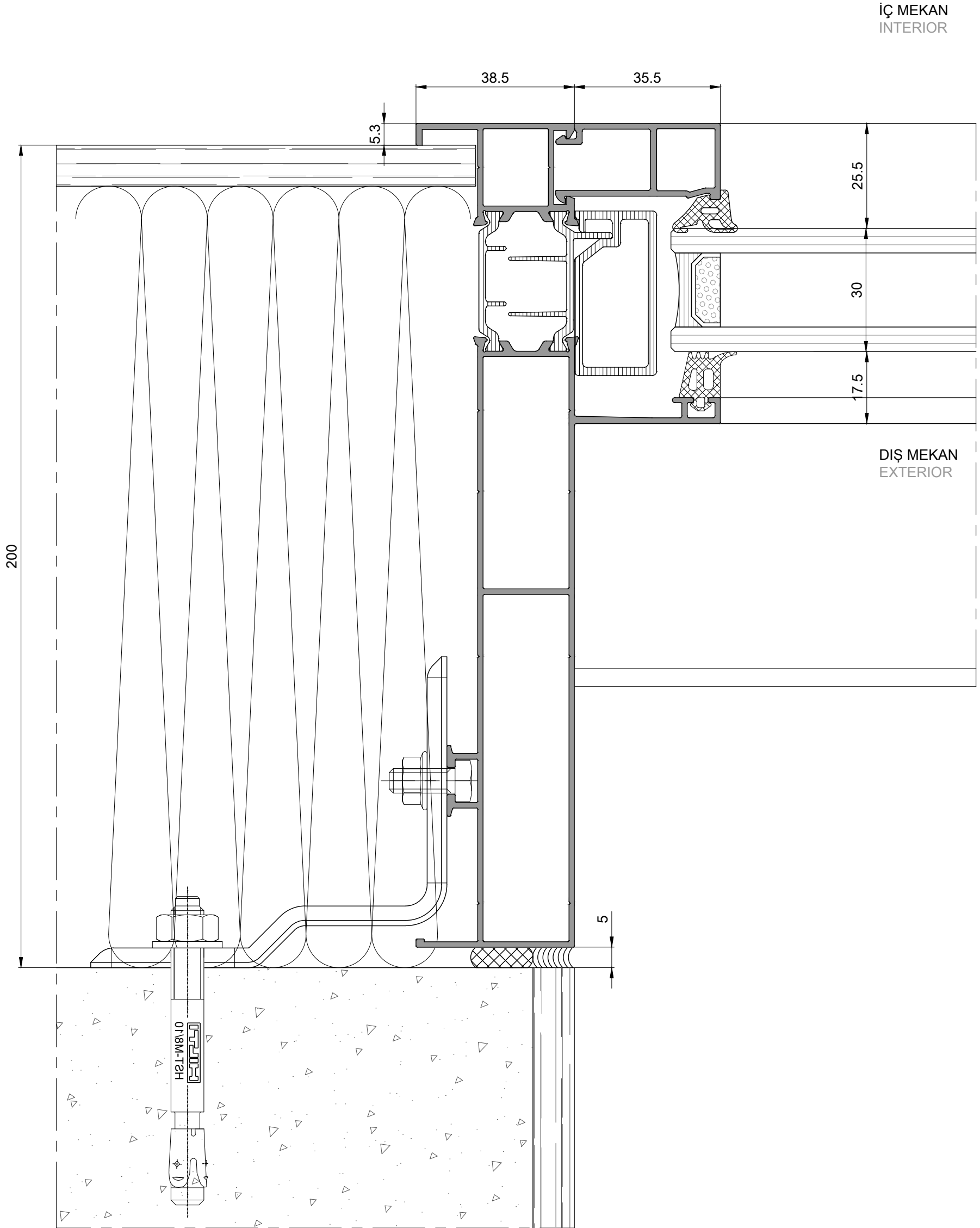
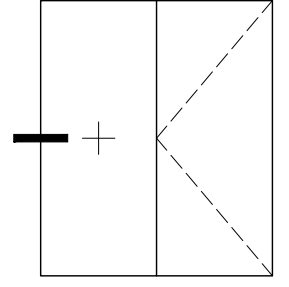

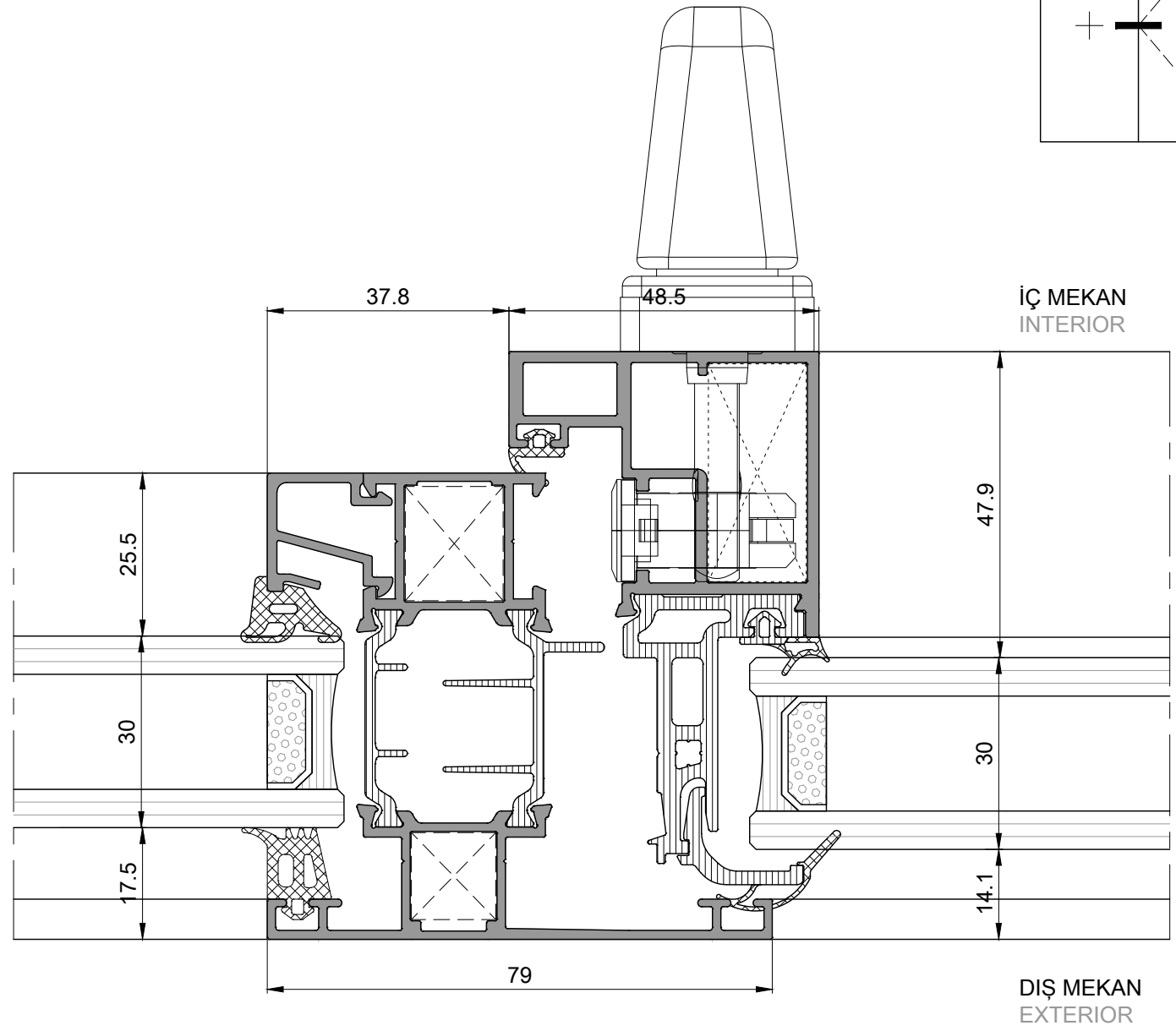
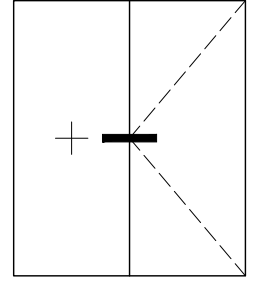

100mm YALITIMLI SAG YAN DETAY
100mm isolation with right side detail

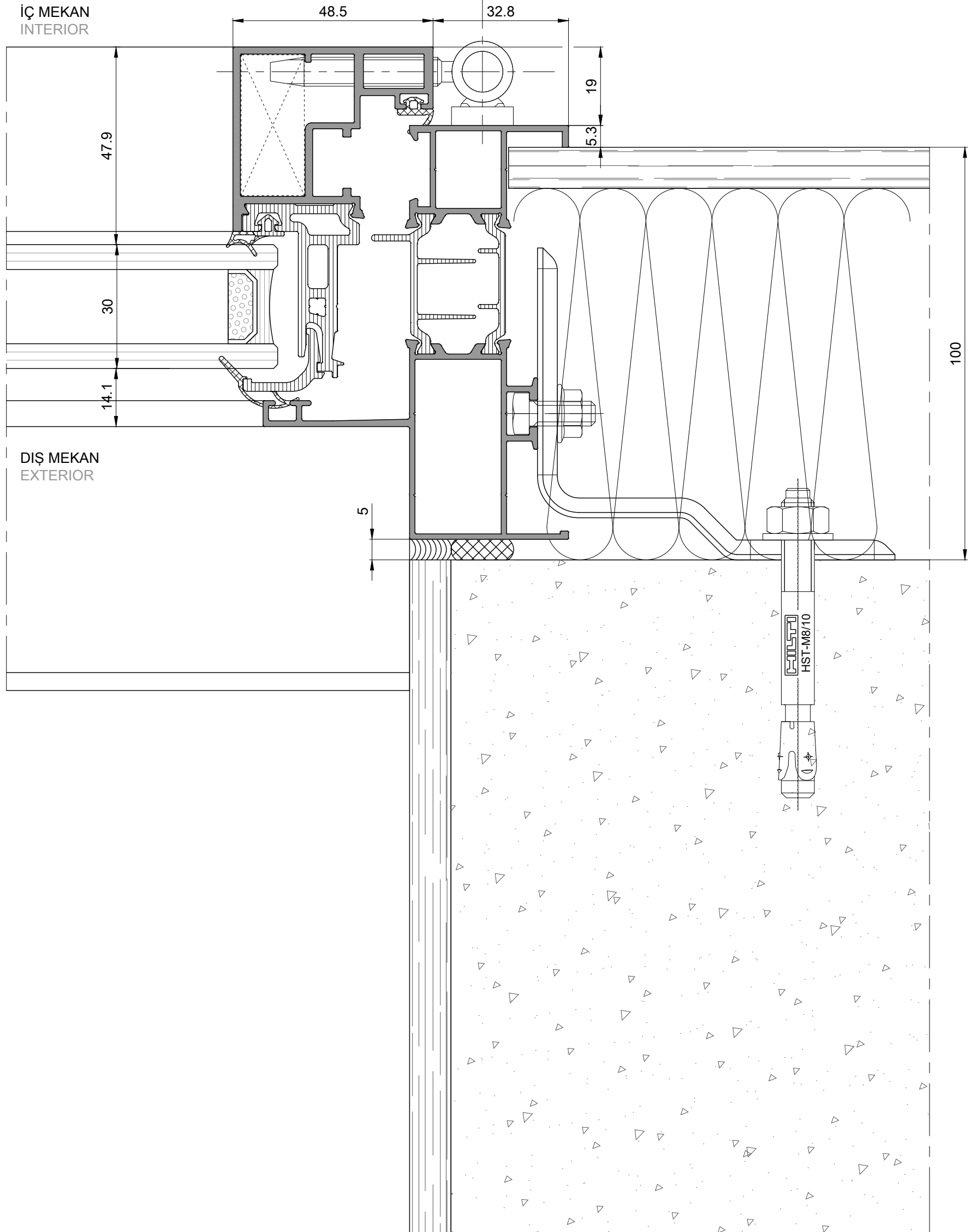
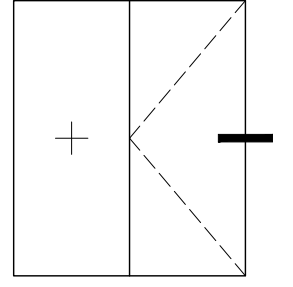

120mm YALITIMLI SAG YAN DETAY
120mm isolation with right side detail

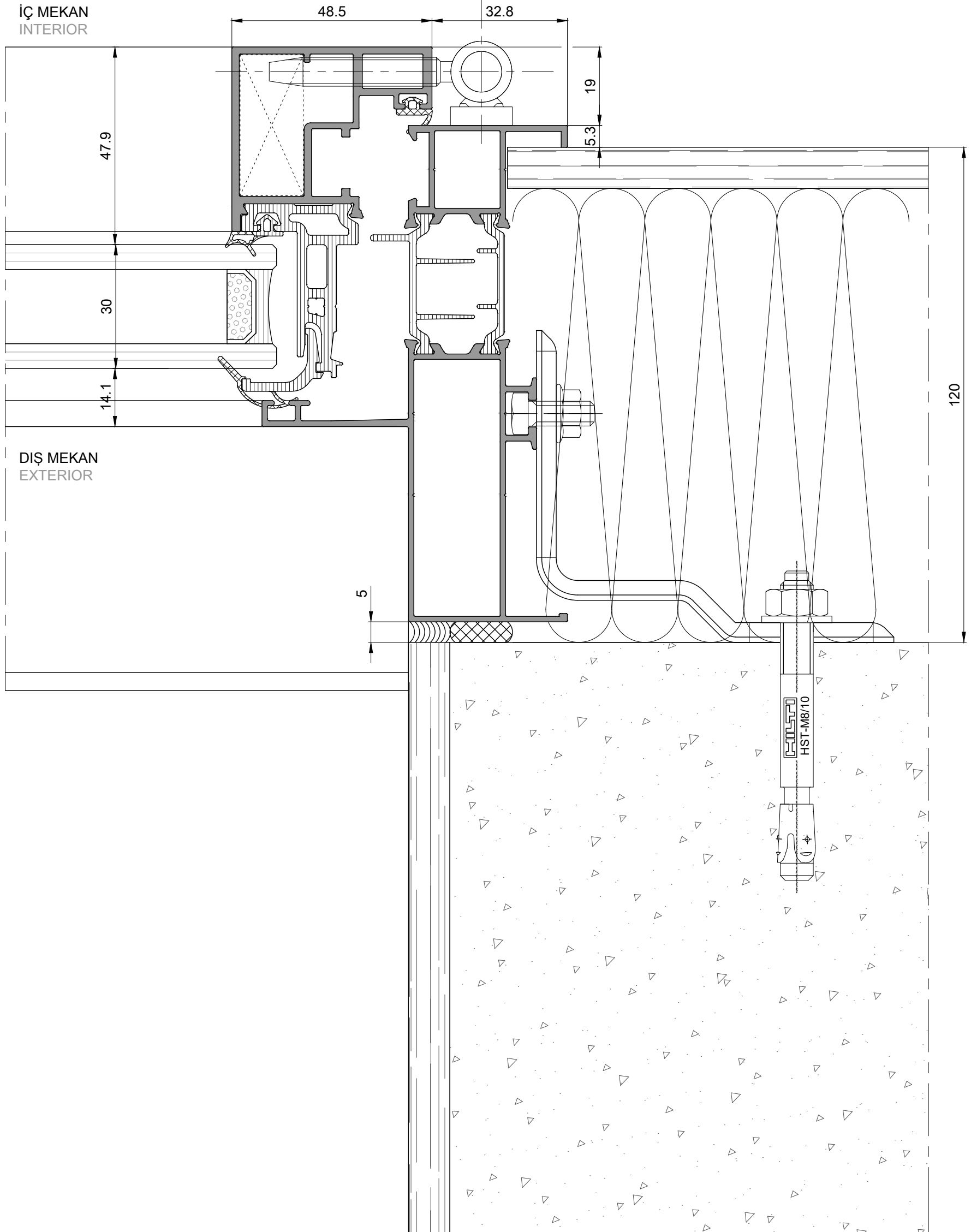
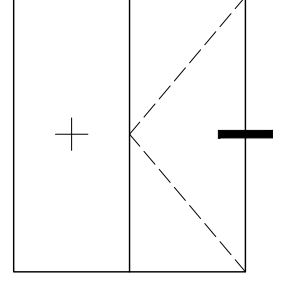

140mm YALITIMLI SAG YAN DETAY
140mm isolation with right side detail

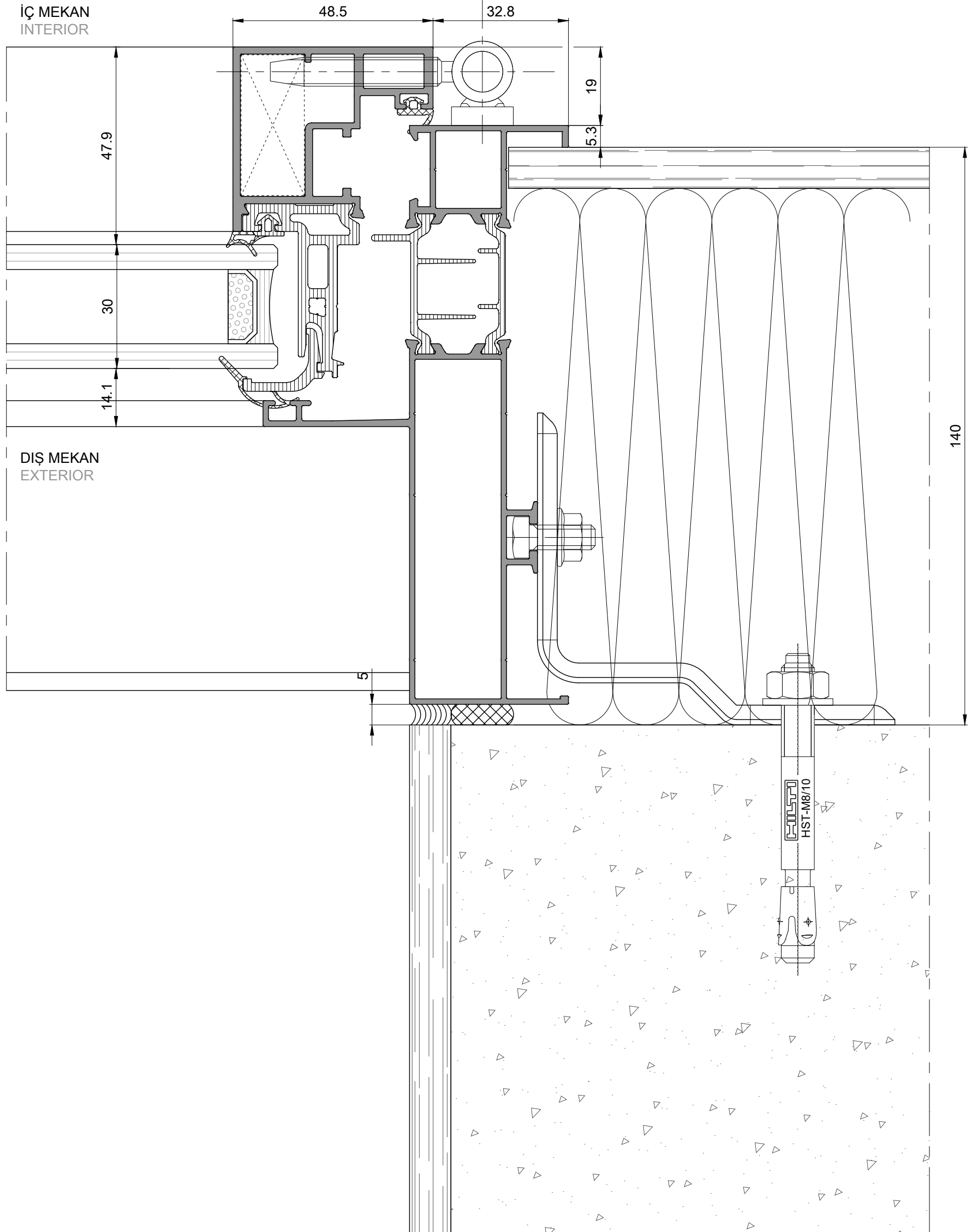
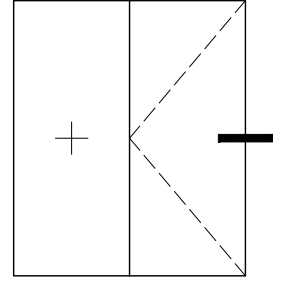

160mm YALITIMLI SAG YAN DETAY
160mm isolation with right side detail

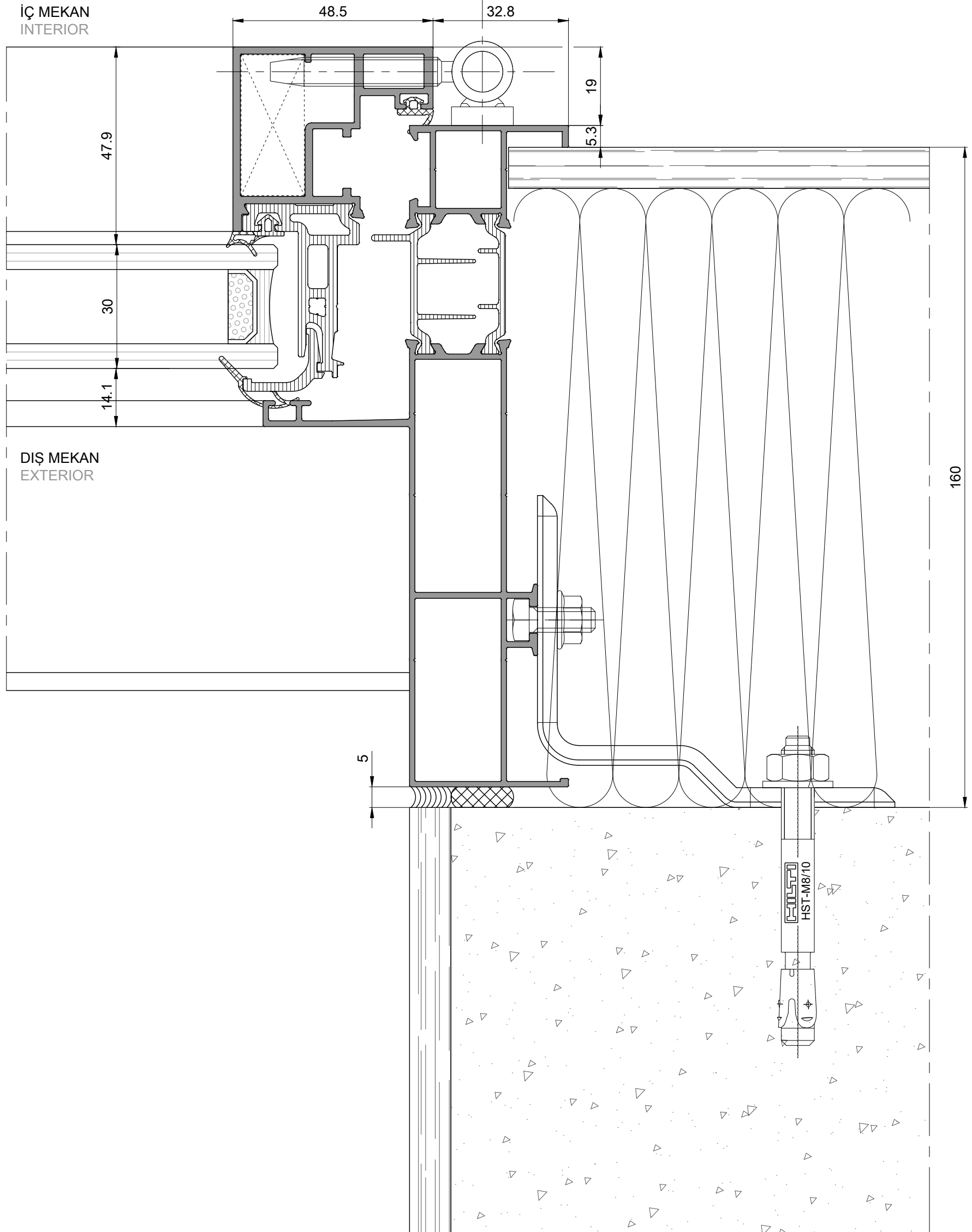
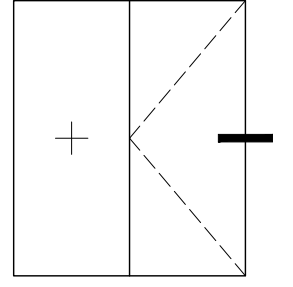

180mm YALITIMLI SAG YAN DETAY
180mm isolation with right side detail

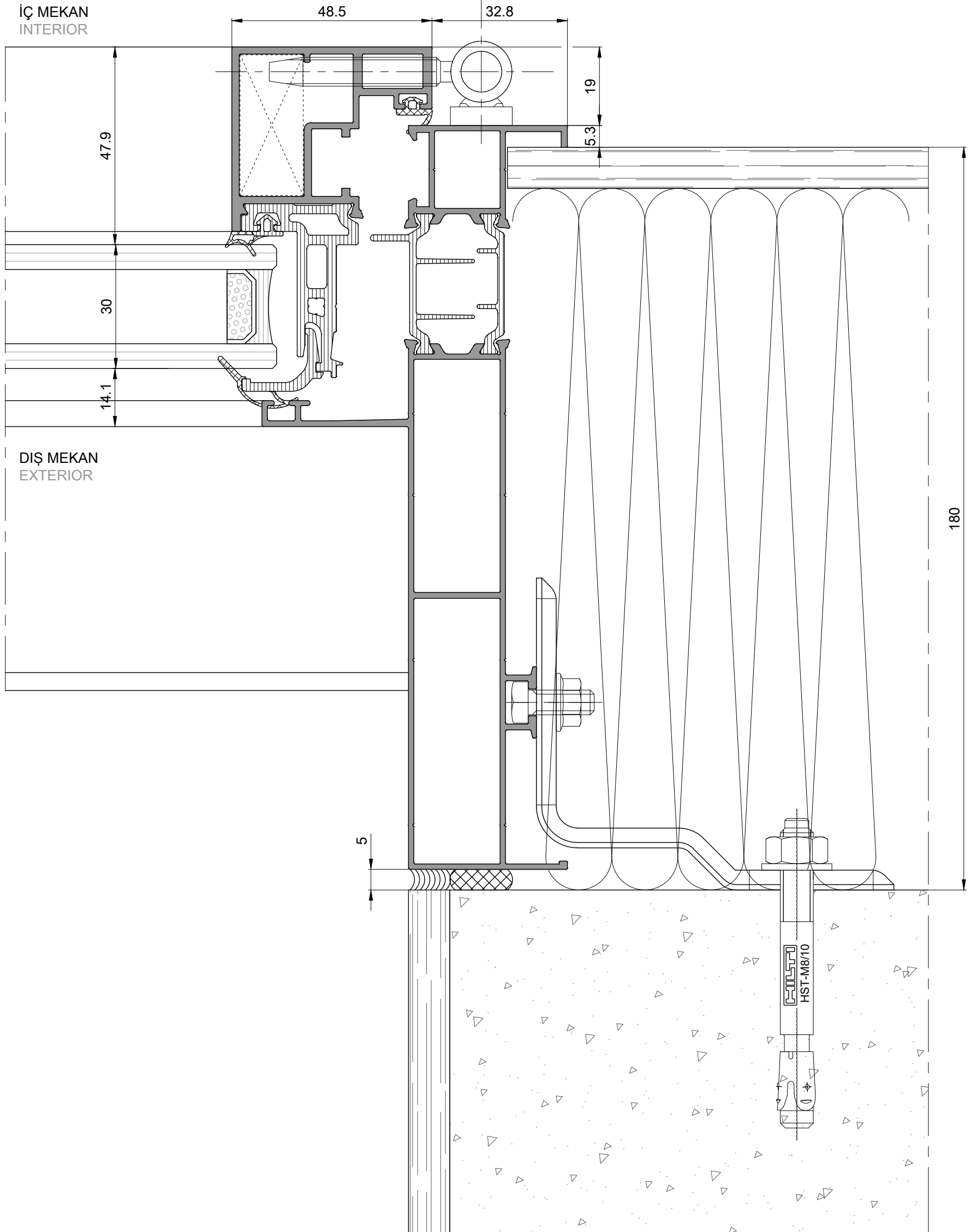
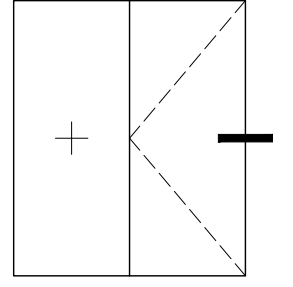

200mm YALITIMLI SAG YAN DETAY
200mm isolation with right side detail

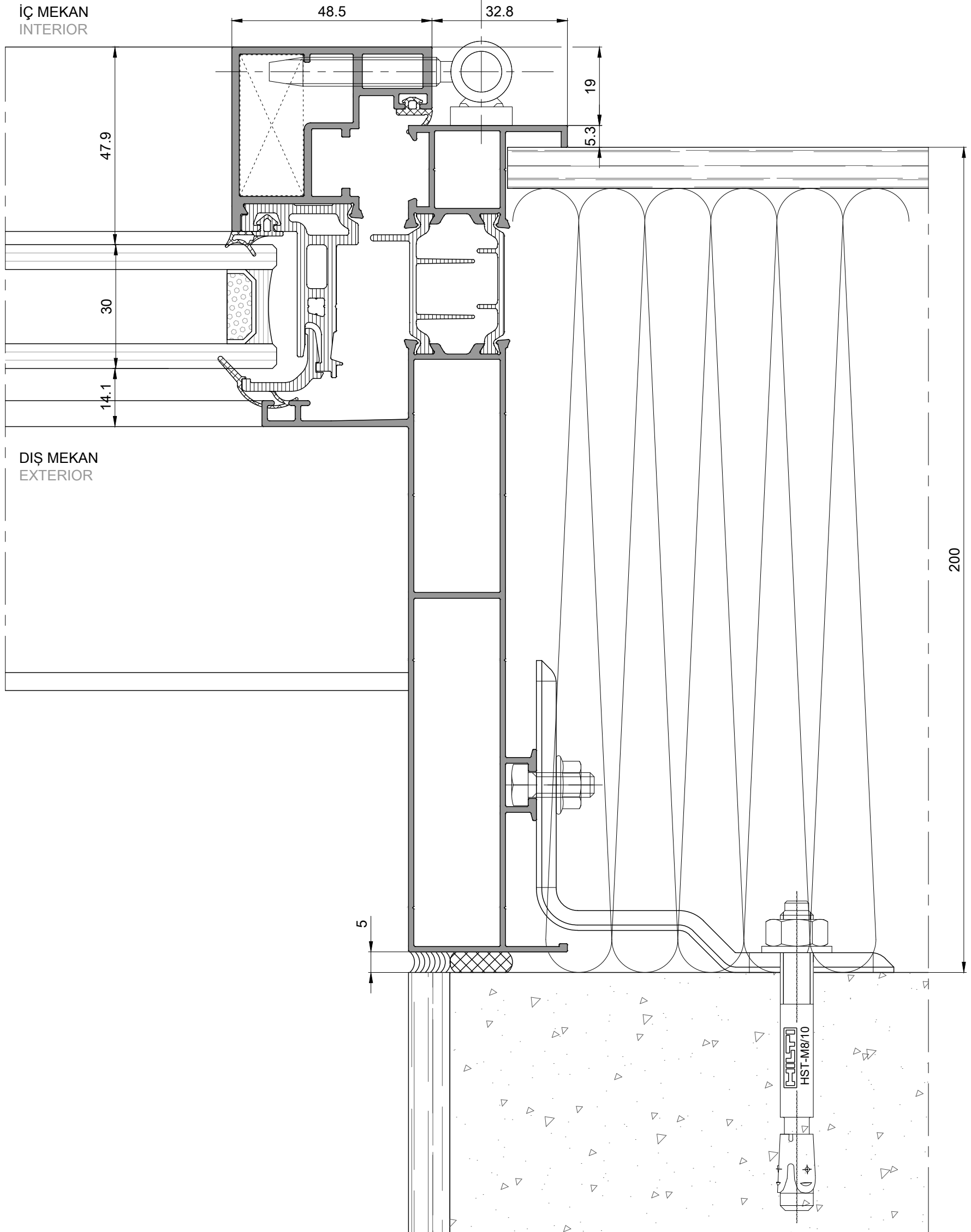
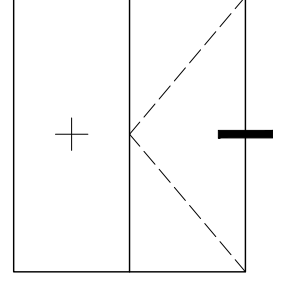

100mm YALITIMLI ÜST DETAY
100mm isolation with top side detail

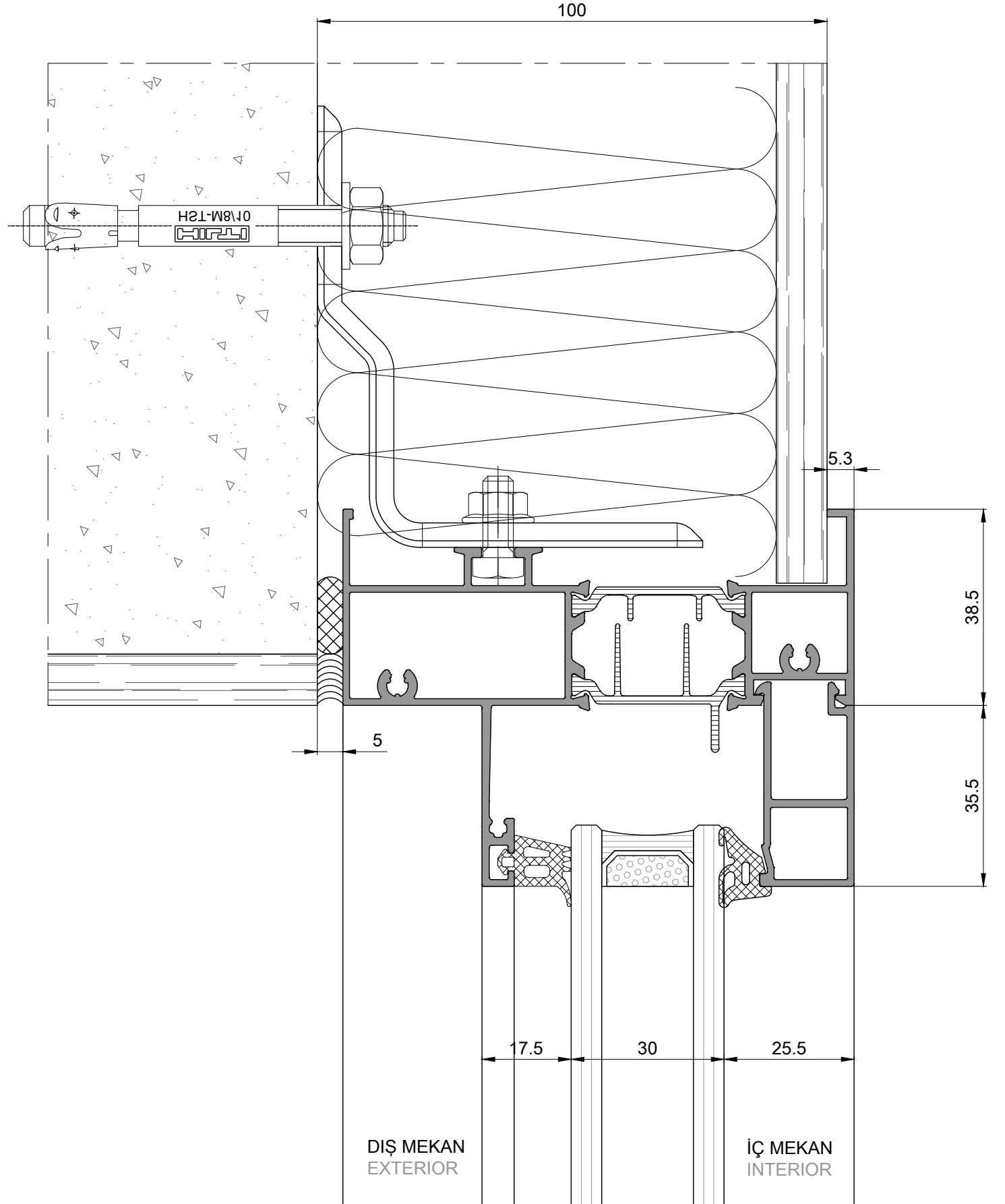
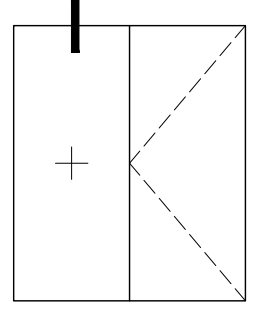

100mm YALITIMLI ÜST DETAY
100mm isolation with top side detail

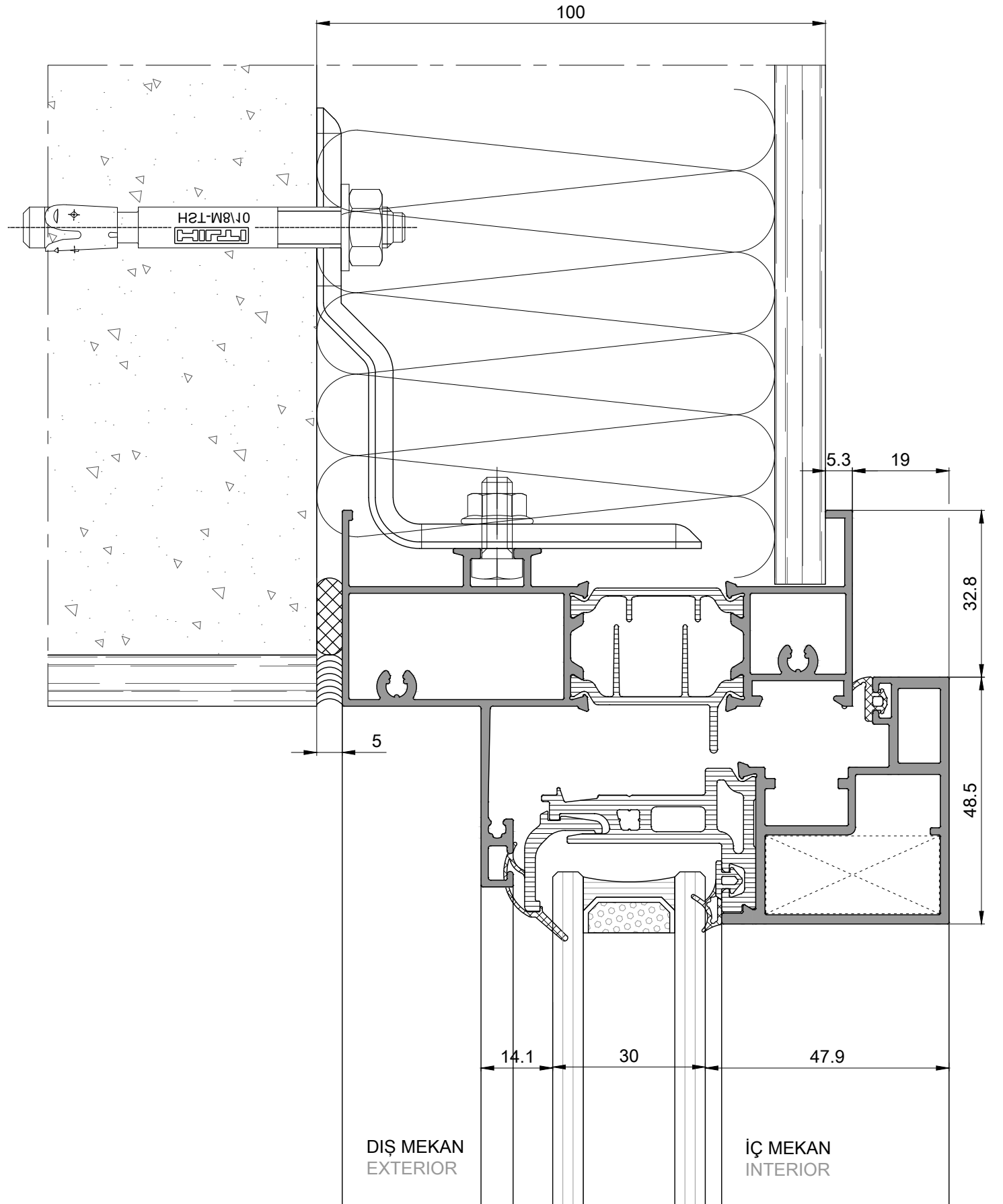
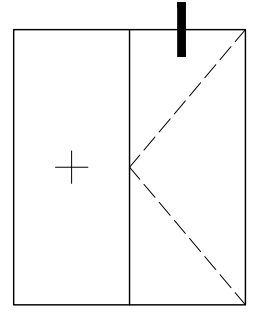

120mm YALITIMLI ÜST DETAY
120mm isolation with top side detail

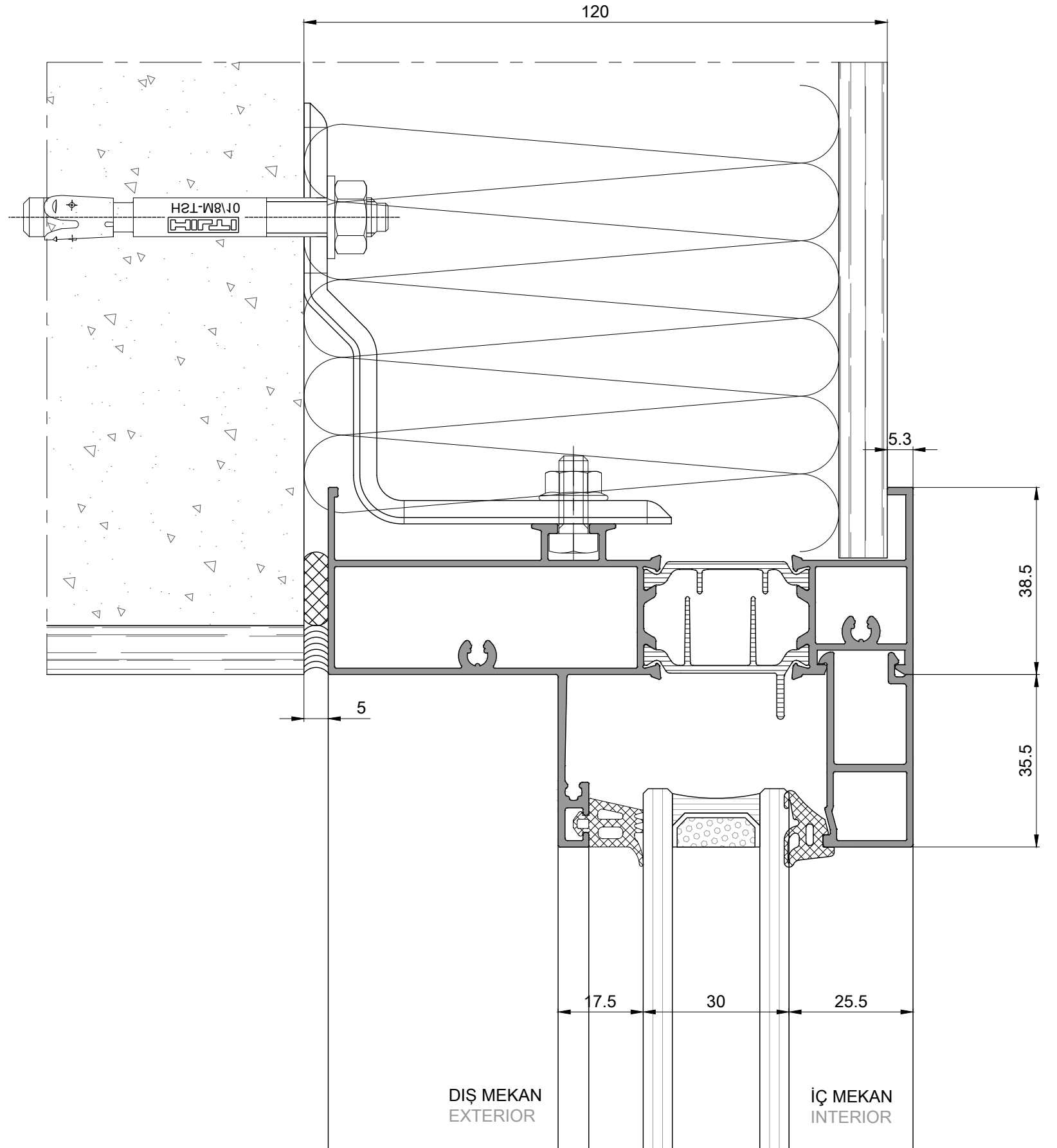
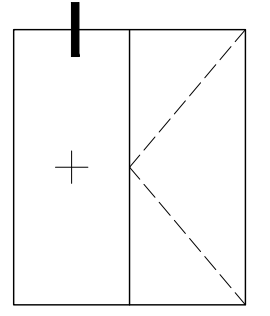

120mm YALITIMLI ÜST DETAY
120mm isolation with top side detail

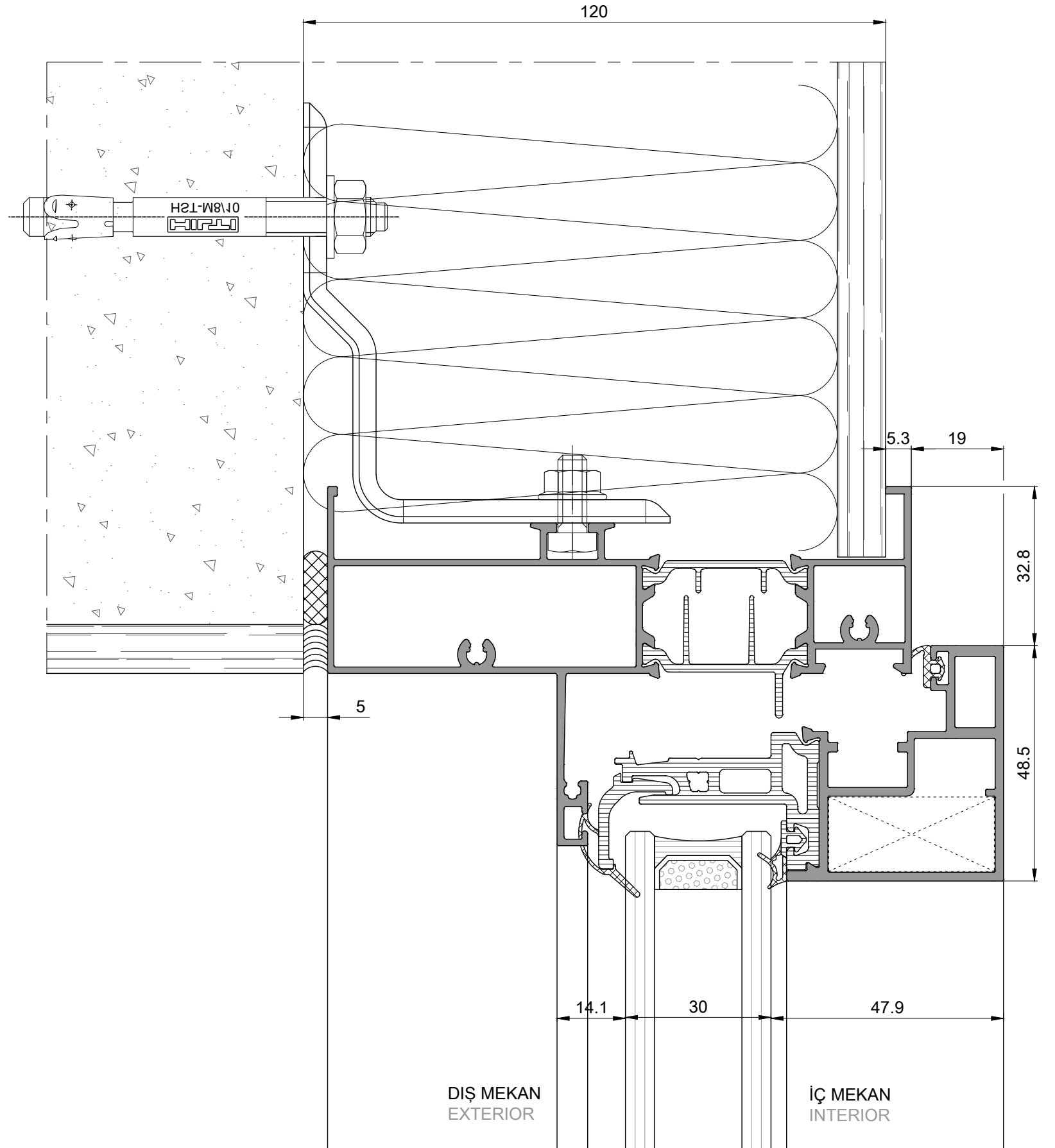
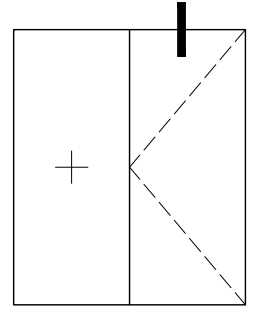

140mm YALITIMLI ÜST DETAY
140mm isolation with top side detail

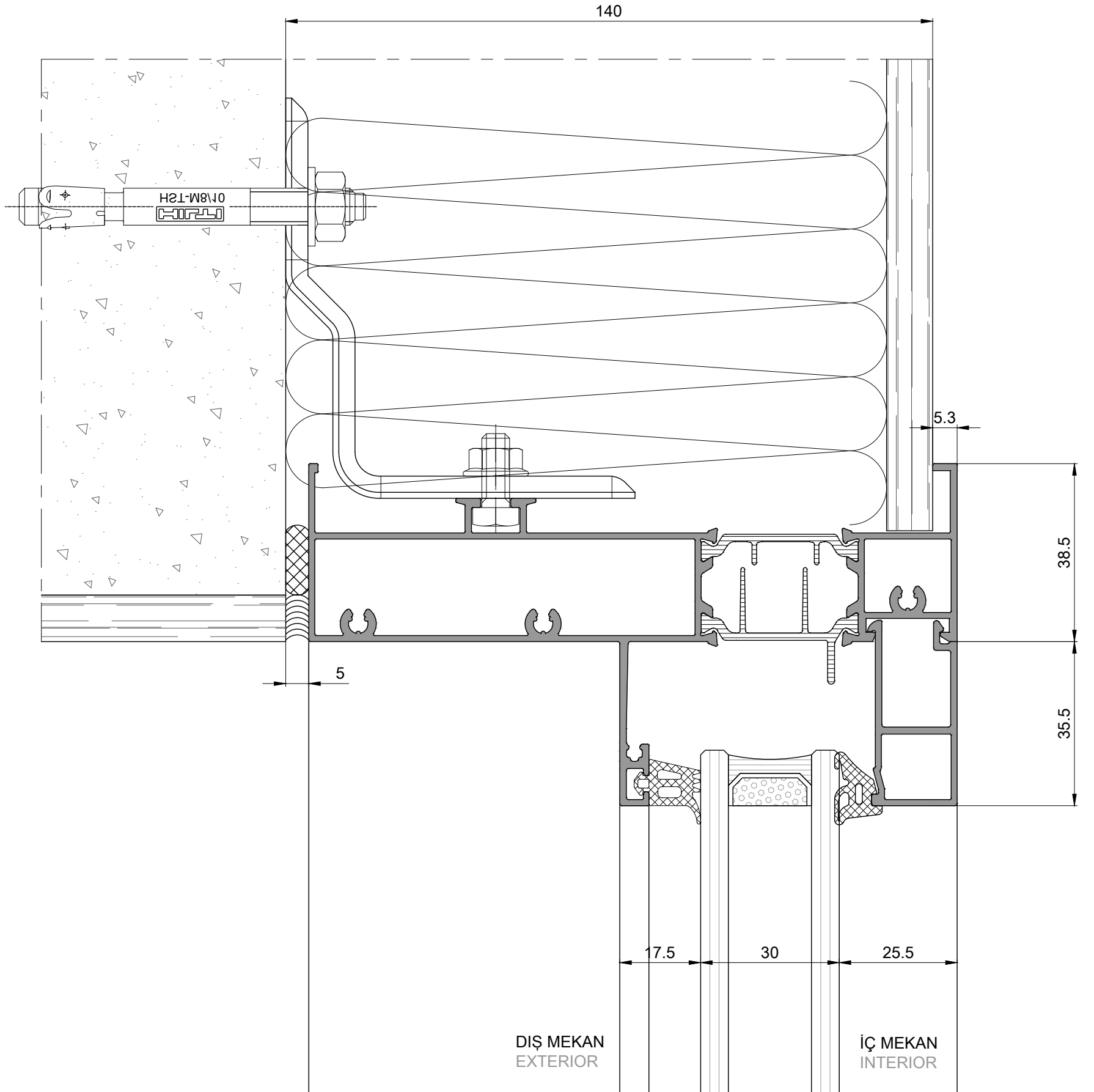
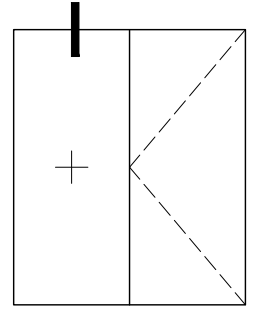

140mm YALITIMLI ÜST DETAY
140mm isolation with top side detail

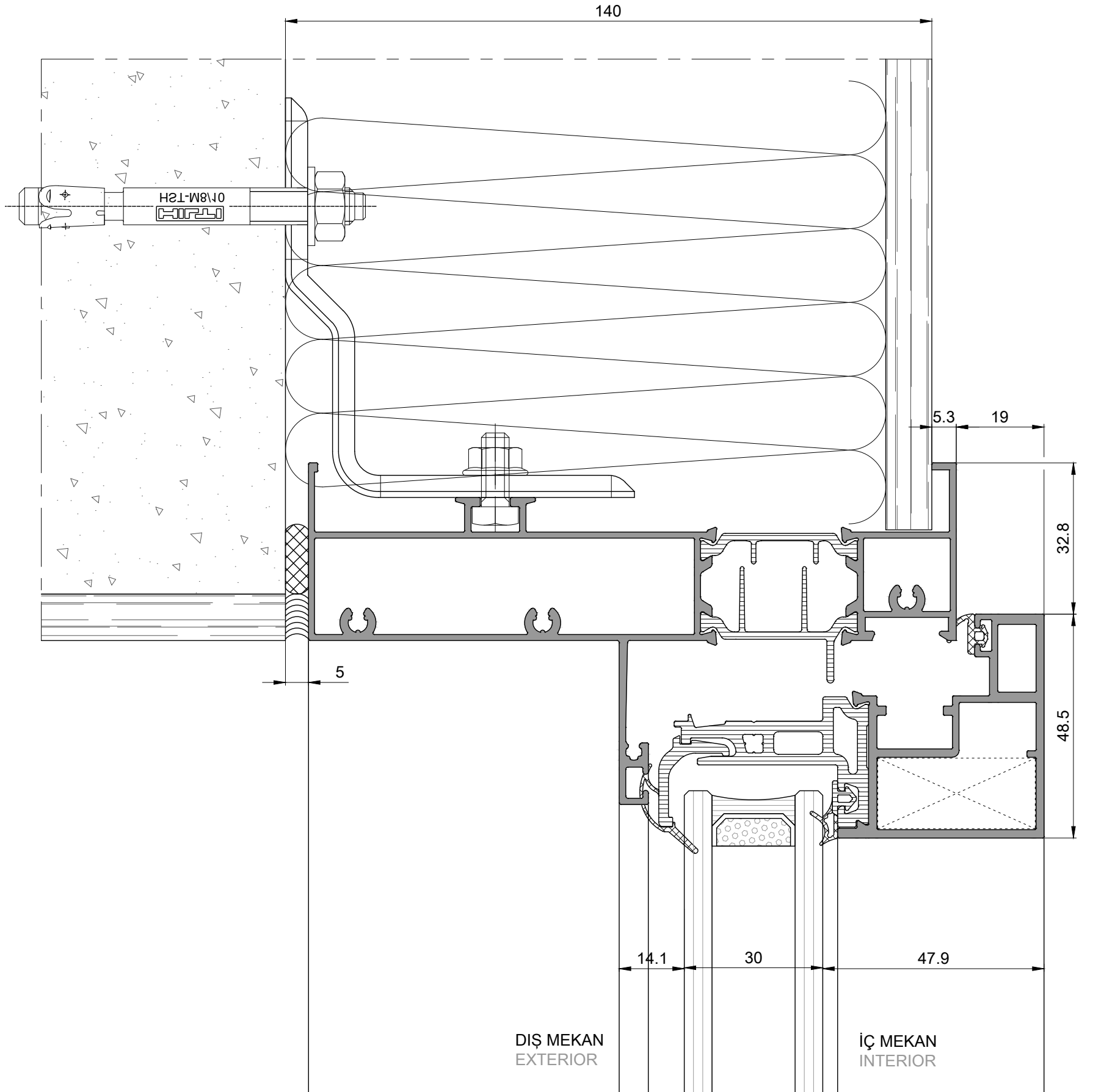
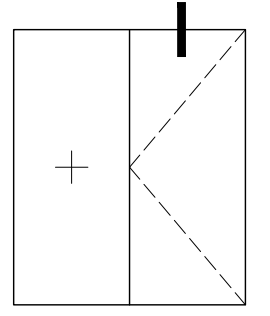

160mm YALITIMLI ÜST DETAY
160mm isolation with top side detail

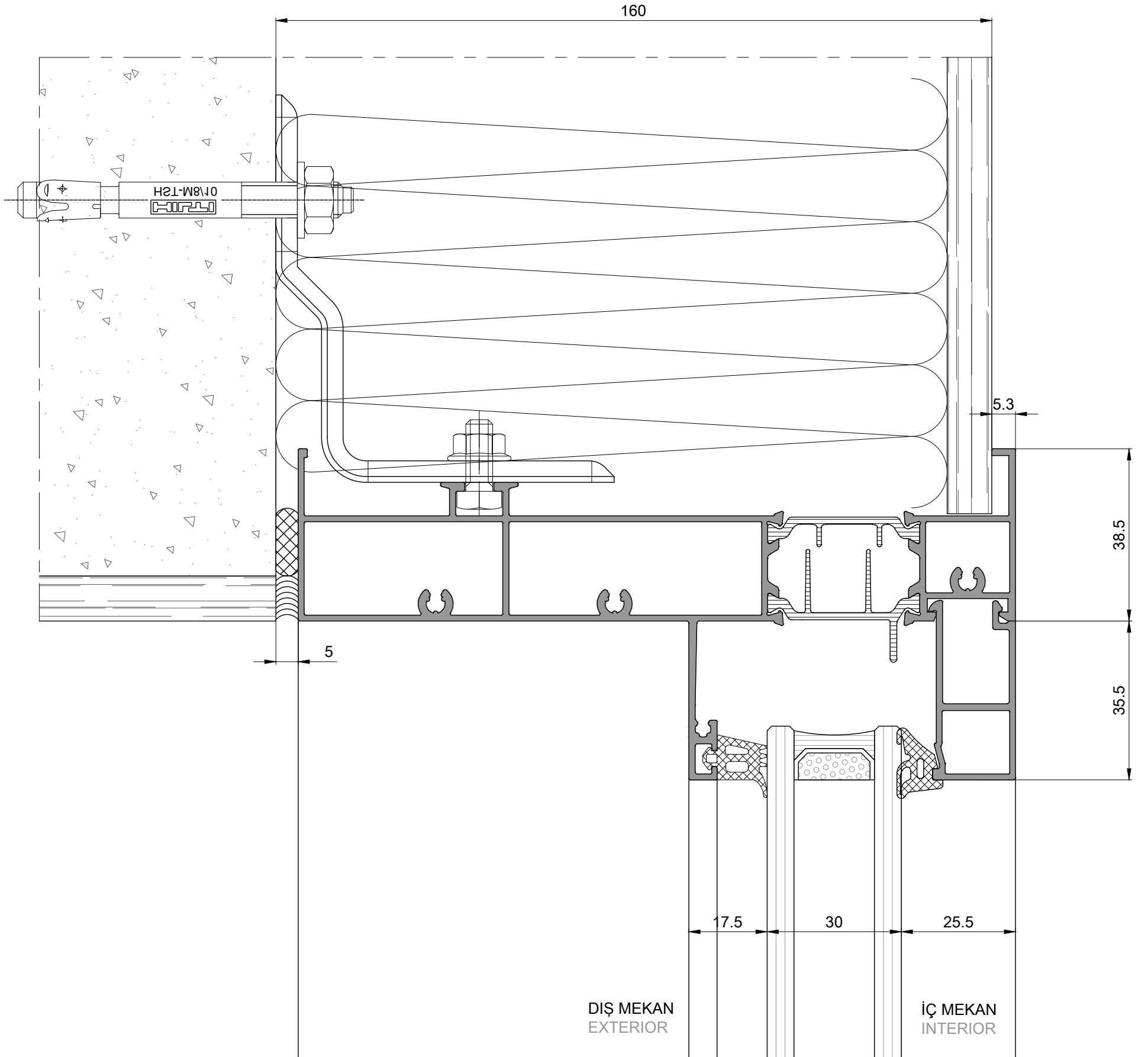
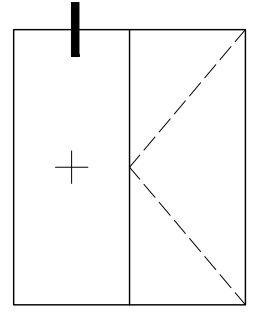

160mm YALITIMLI ÜST DETAY
160mm isolation with top side detail

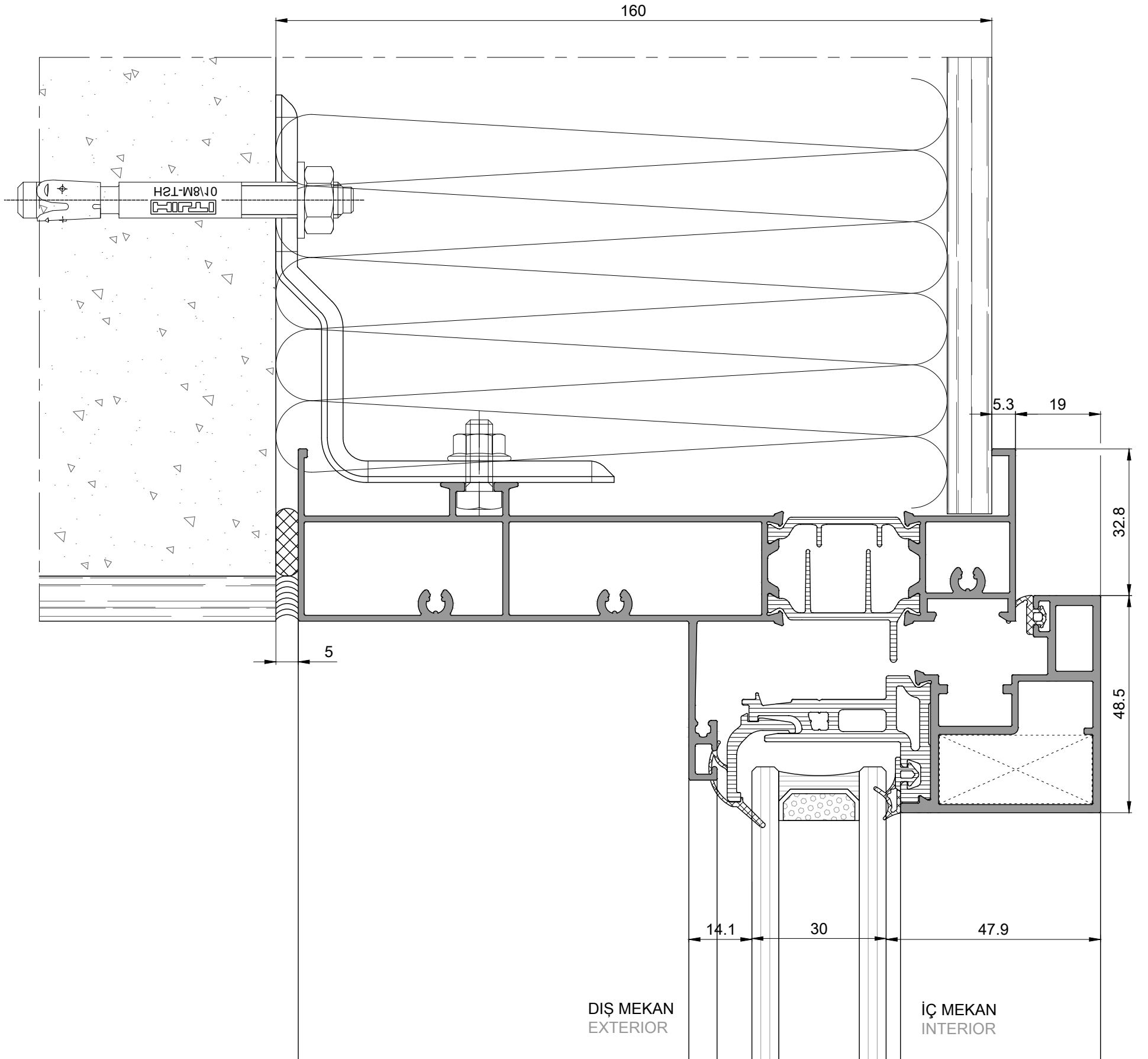
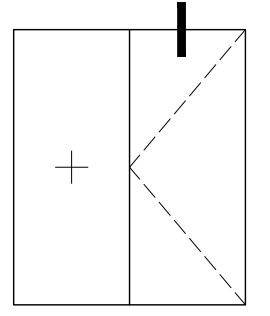

180mm YALITIMLI ÜST DETAY
180mm isolation with top side detail

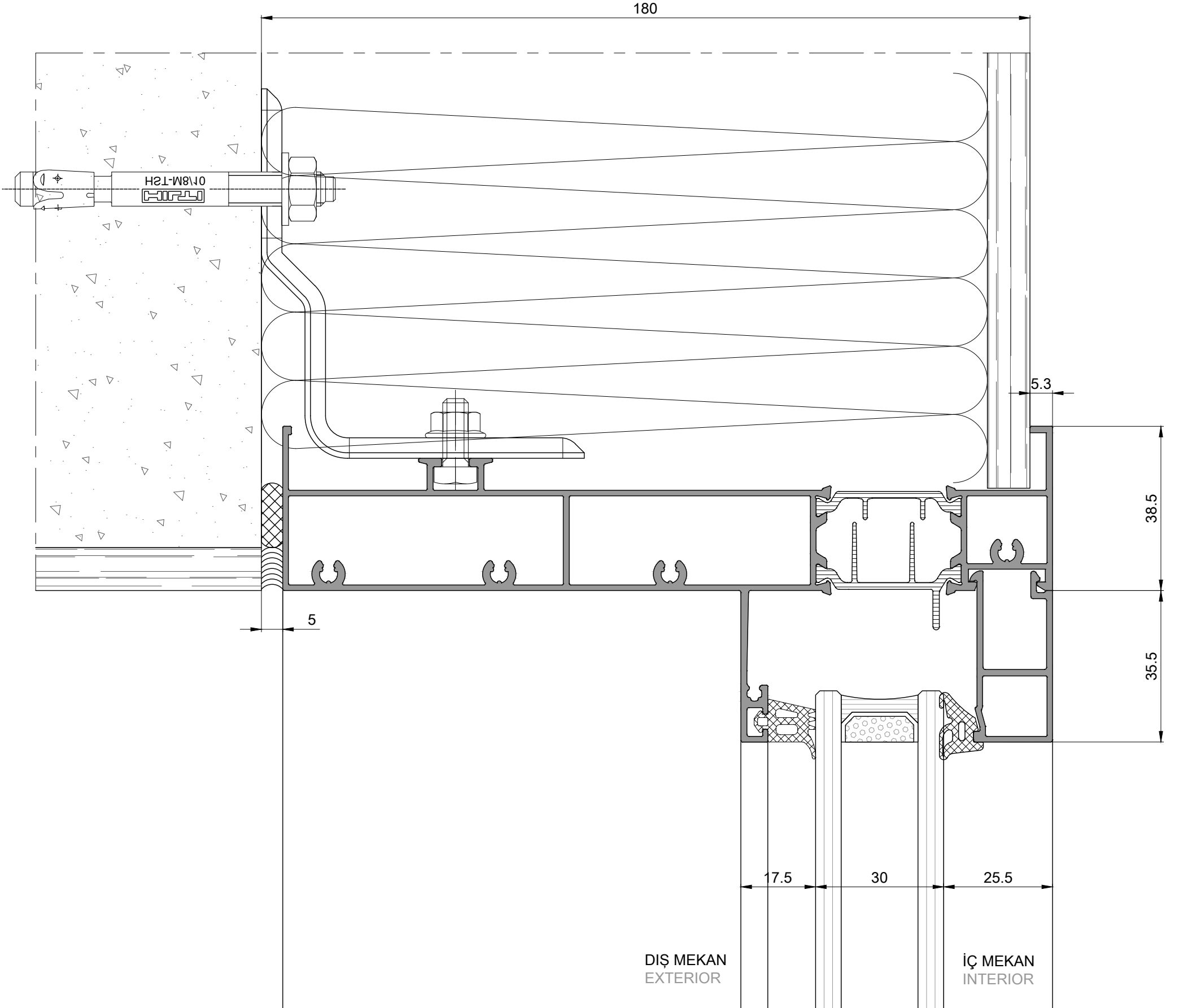
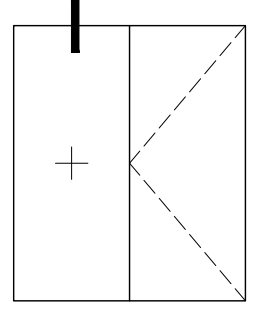

180mm YALITIMLI ÜST DETAY
180mm isolation with top side detail

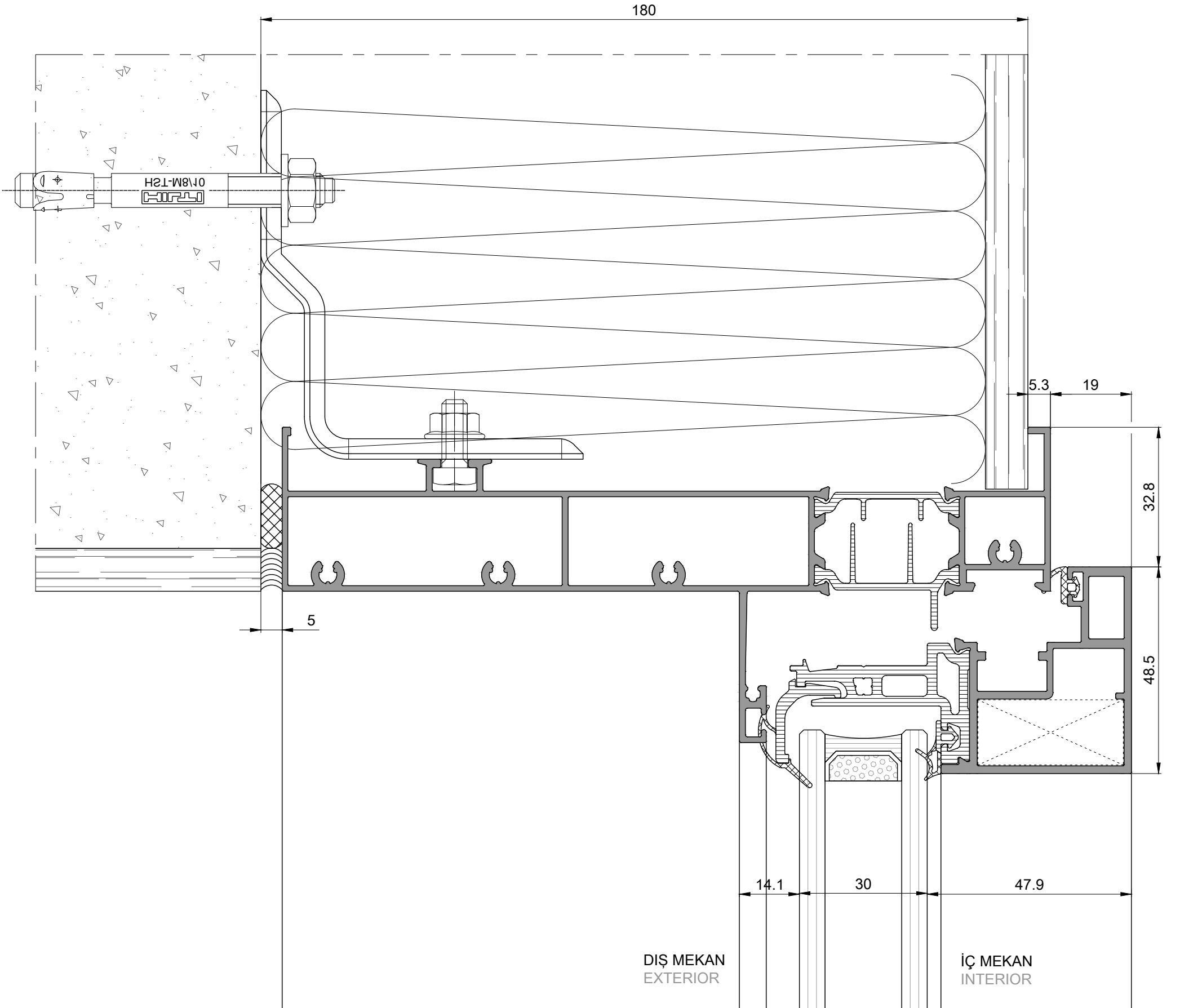
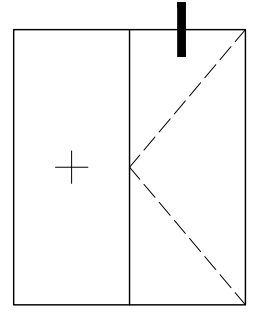

200mm YALITIMLI ÜST DETAY
200mm isolation with top side detail

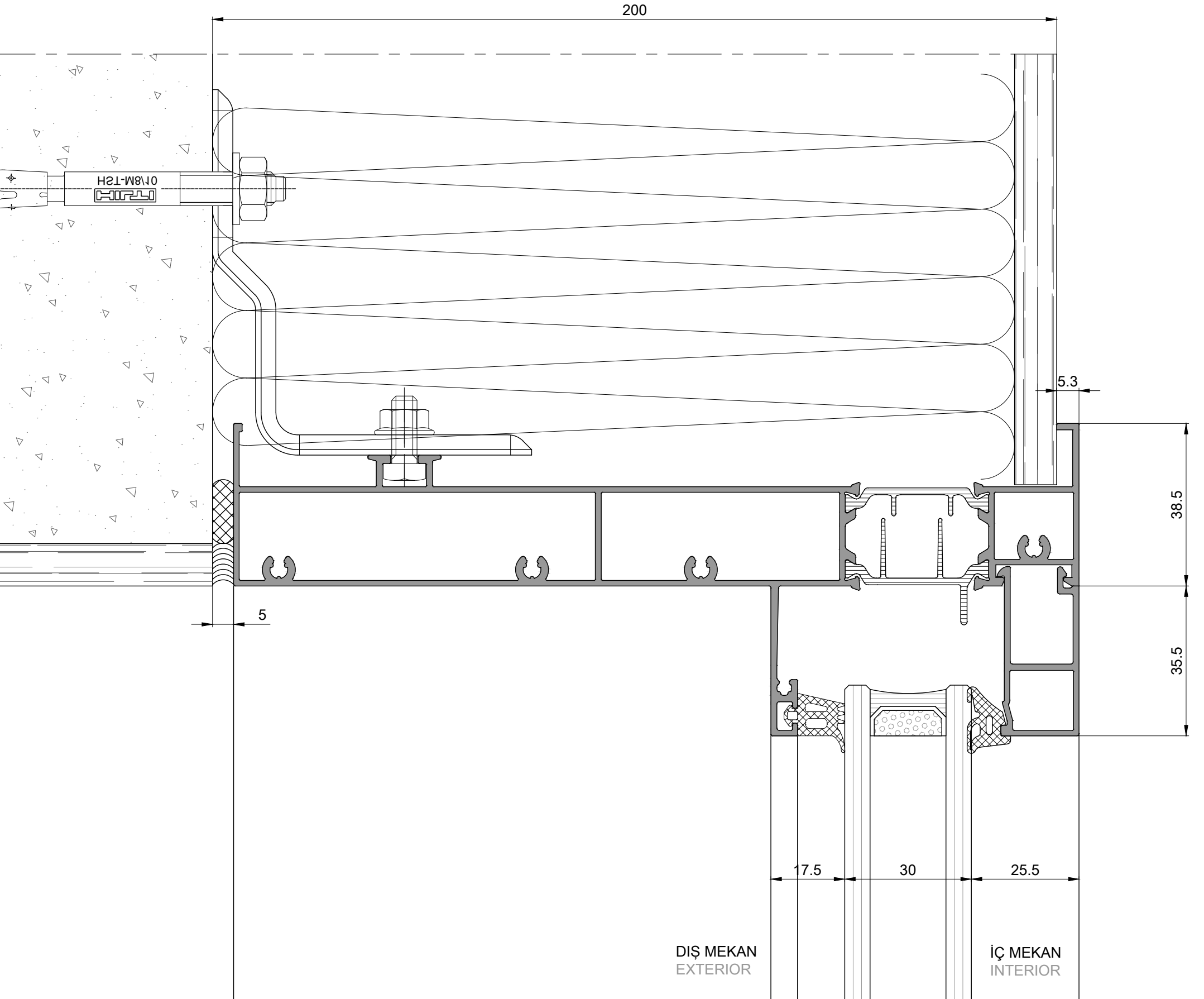
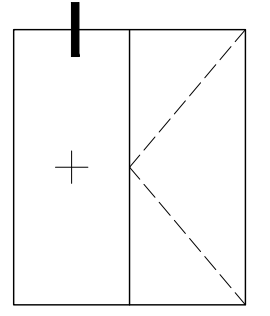

200mm YALITIMLI ÜST DETAY
200mm isolation with top side detail

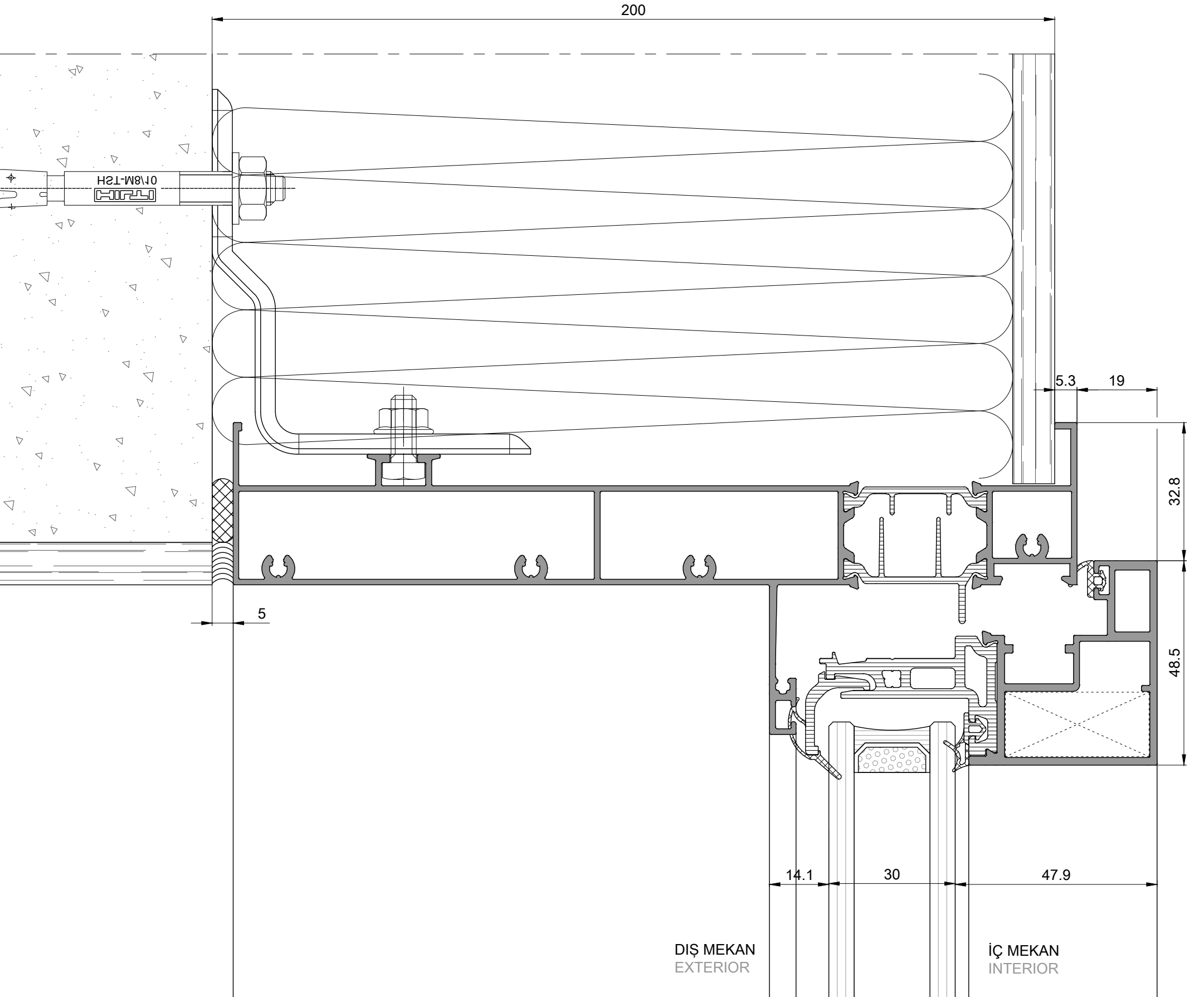
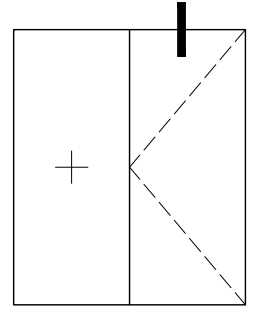

100-120-140mm YALITIMLI ALT DETAY
100-120-140mm isolation with bottom side detail

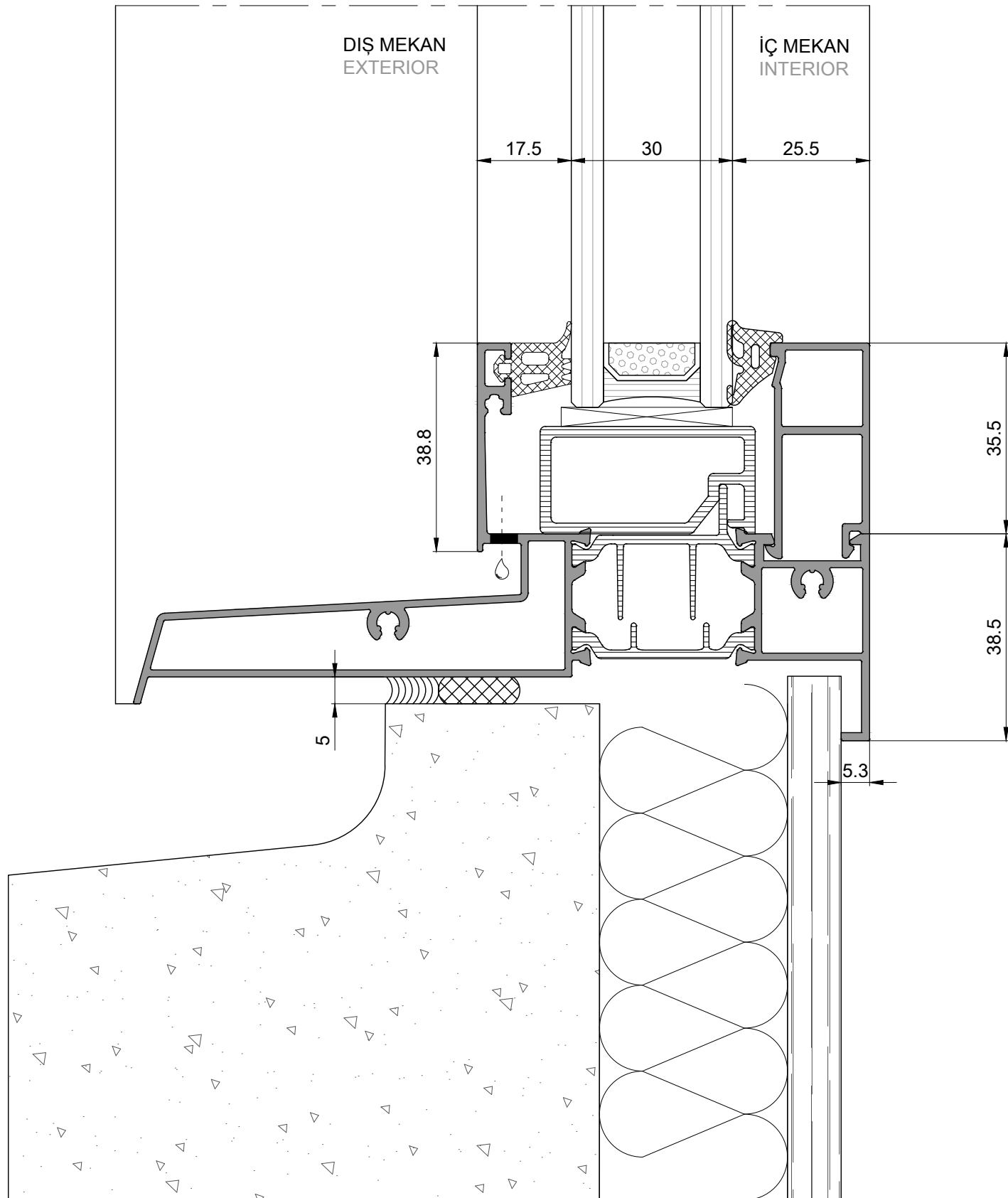
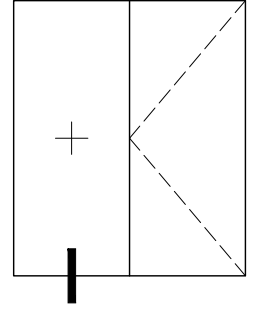

160-180-200mm YALITIMLI ALT DETAY
160-180-200mm isolation with bottom side detail

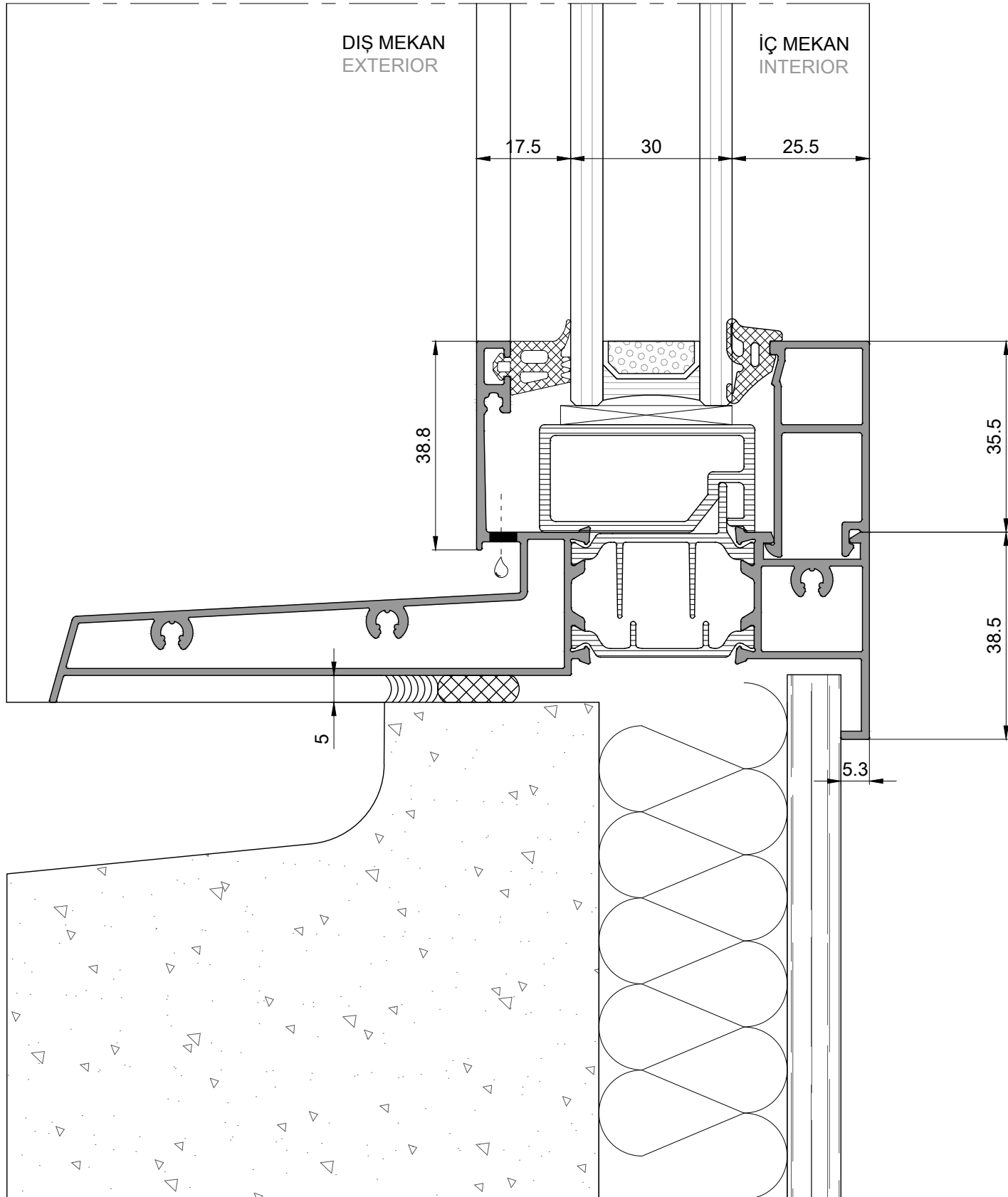
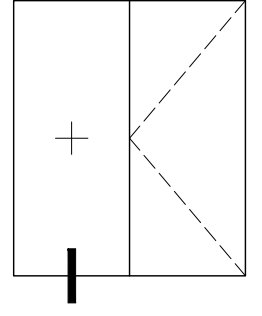

100-120-140mm YALITIMLI ALT DETAY
100-120-140mm isolation with bottom side detail

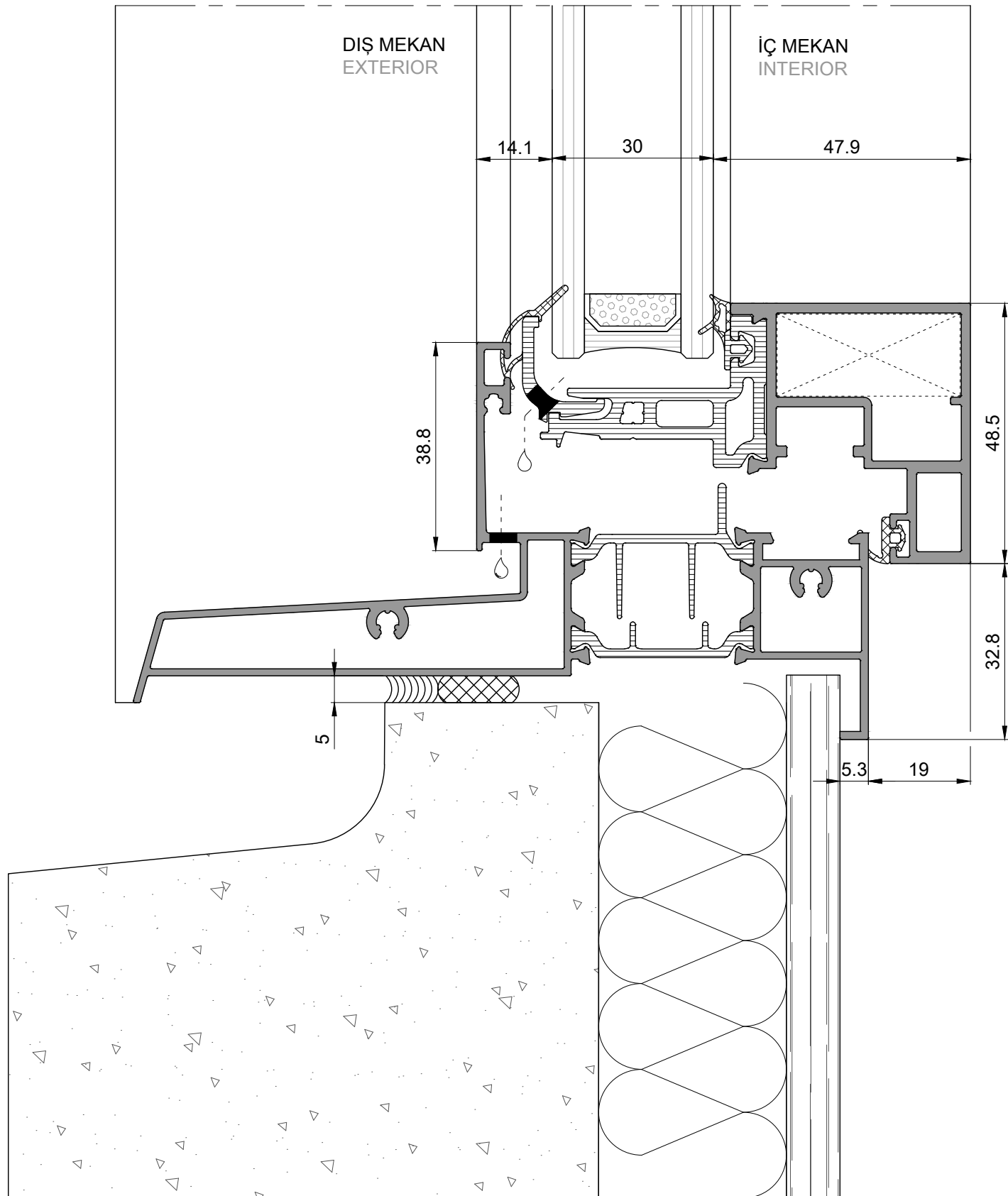
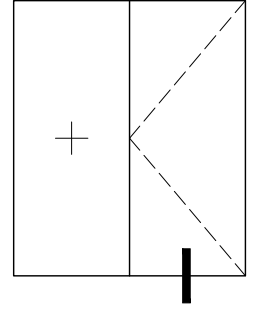

160-180-200mm YALITIMLI ALT DETAY
160-180-200mm isolation with bottom side detail

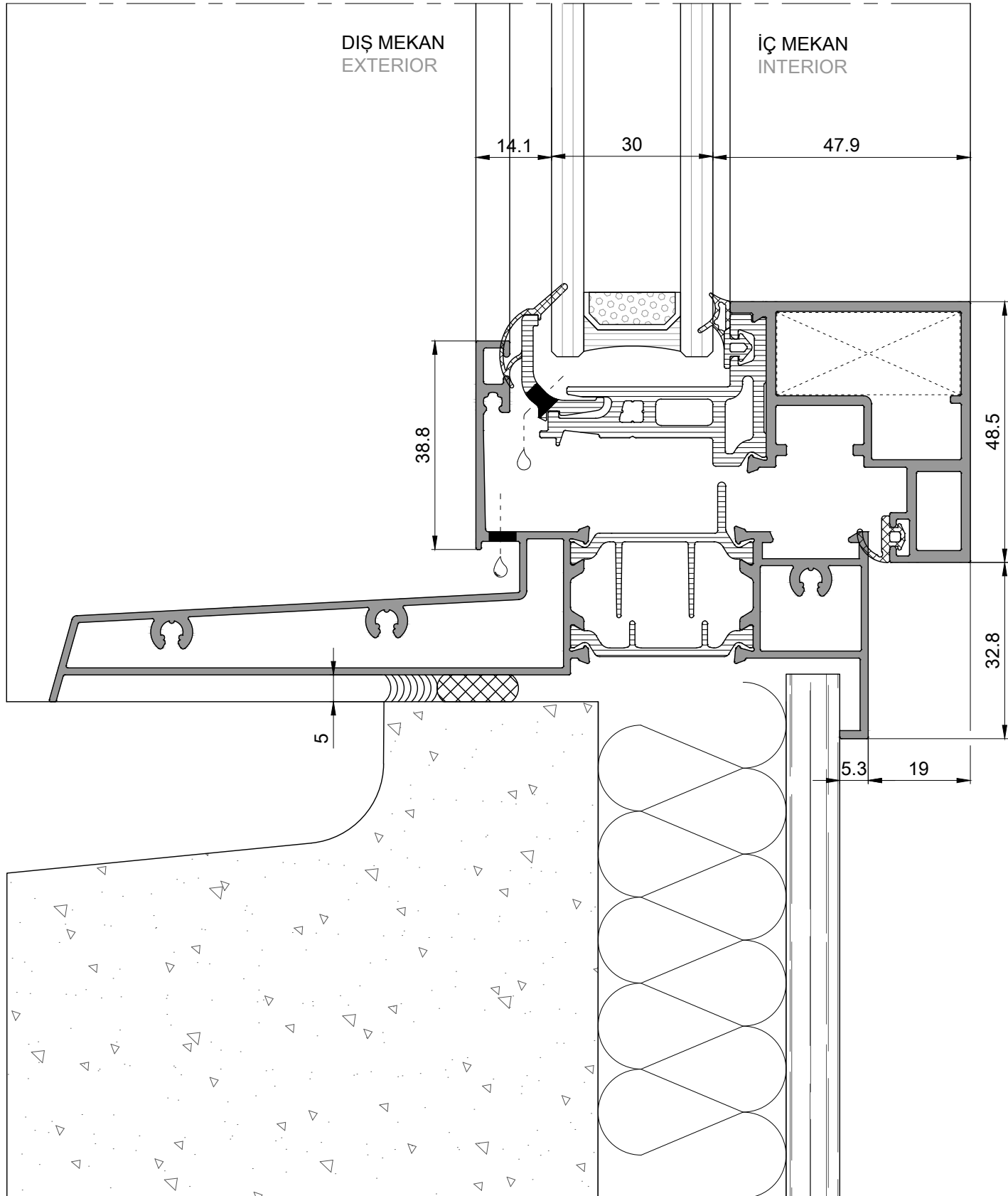
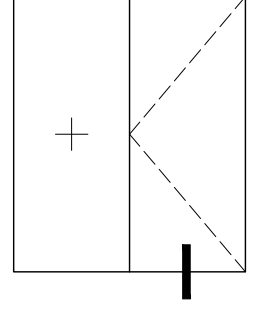

KAPI ALT EŞİK DETAY
Door bottom side threshold detail

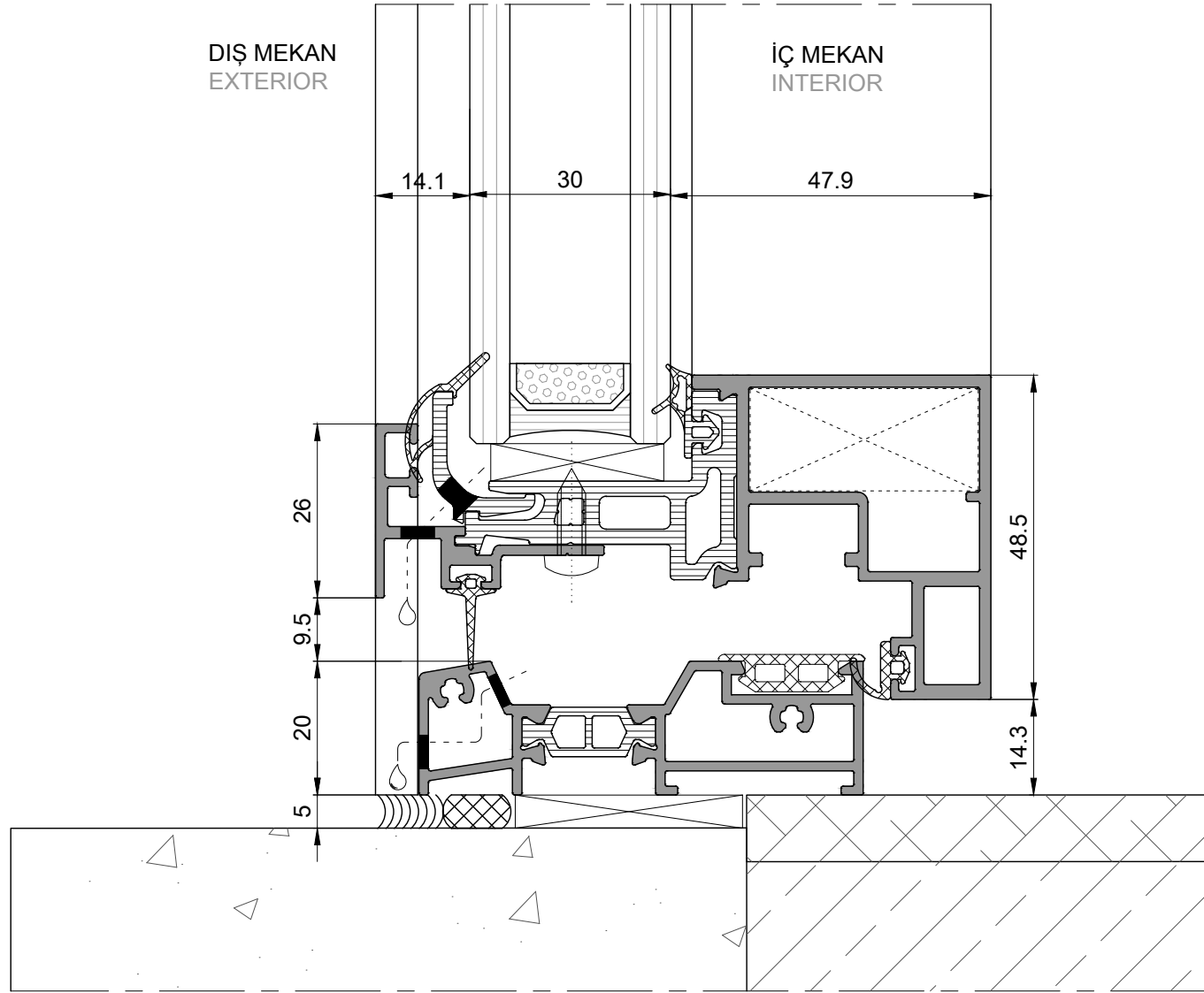
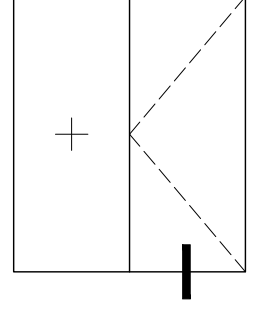

SABİT ALT DETAY
fixed glass bottom detail

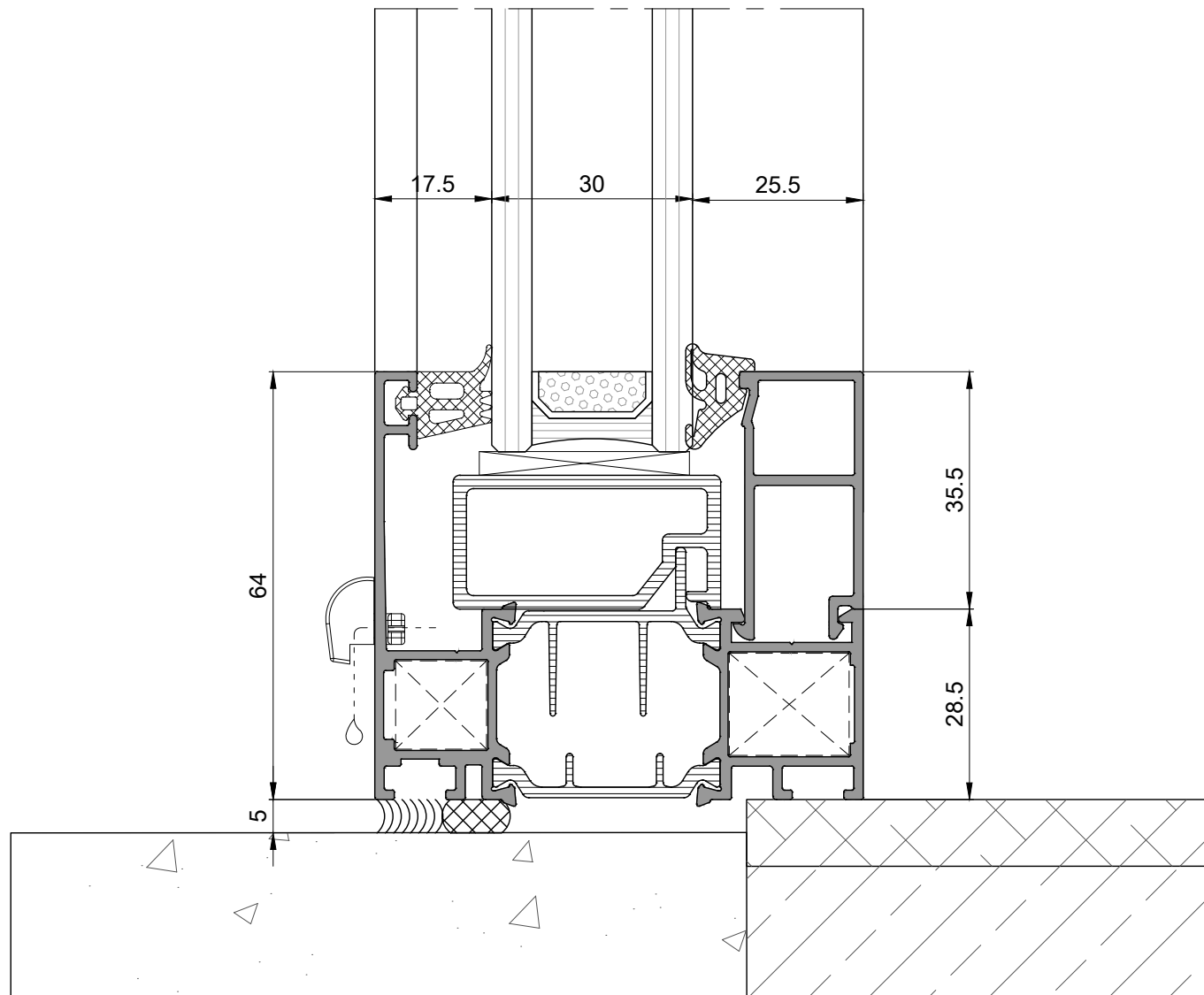
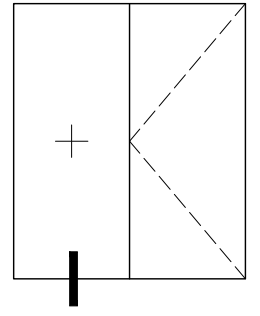

ALFA

GİZLİ KANATLI PENCERE ve KAPI SİSTEMİ CONCEALED SASH WINDOW and DOOR SYSTEM

GİRİŞ KAPILARI PRENSİP SİSTEM DETAYLARI PRINCIPAL SECTIONS for ENTRANCE DOOR SYSTEM

100mm YALITIMLI SOL YAN DETAY
100mm isolation with left side detail

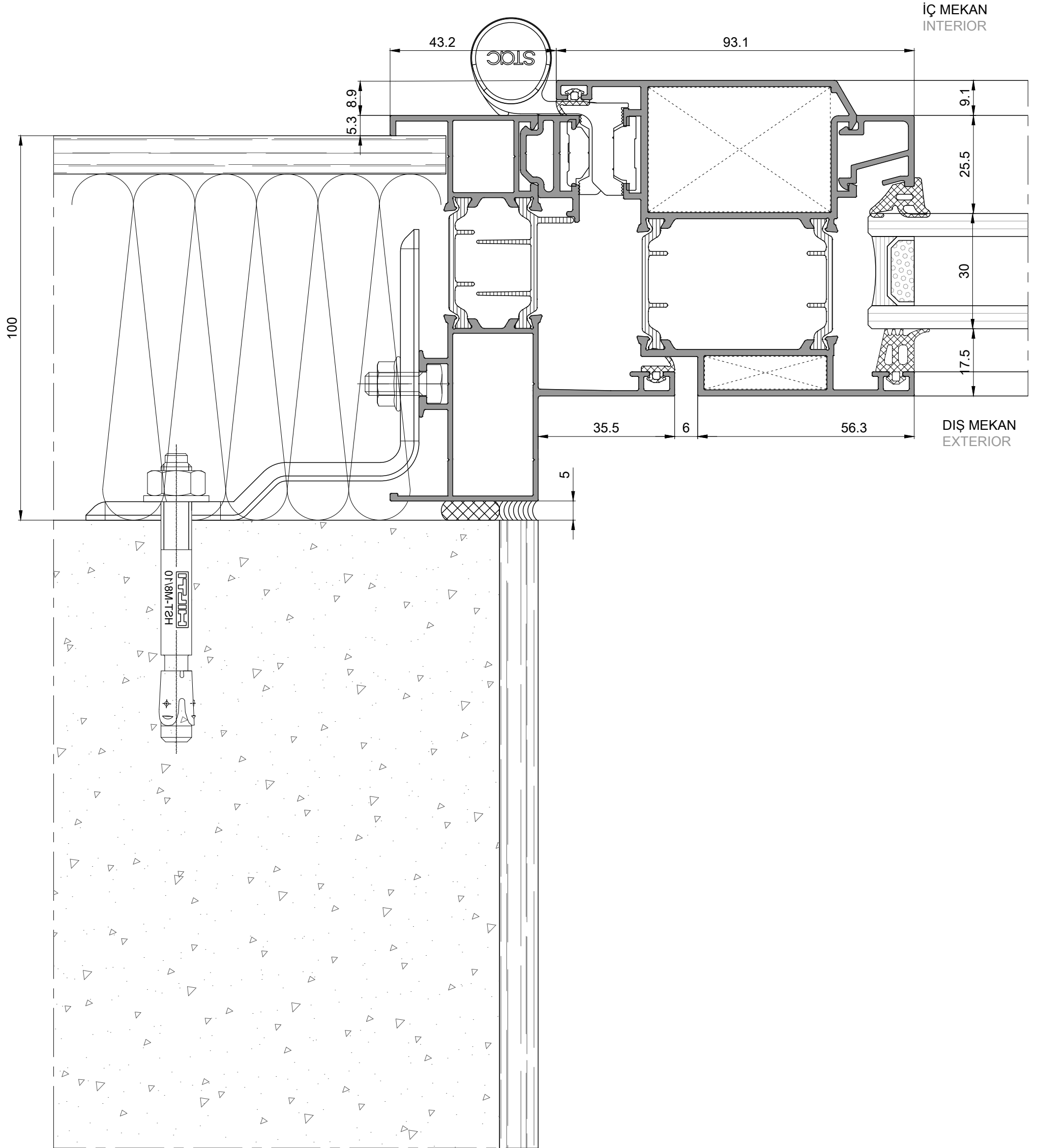
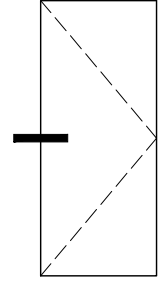

120mm YALITIMLI SOL YAN DETAY
120mm isolation with left side detail

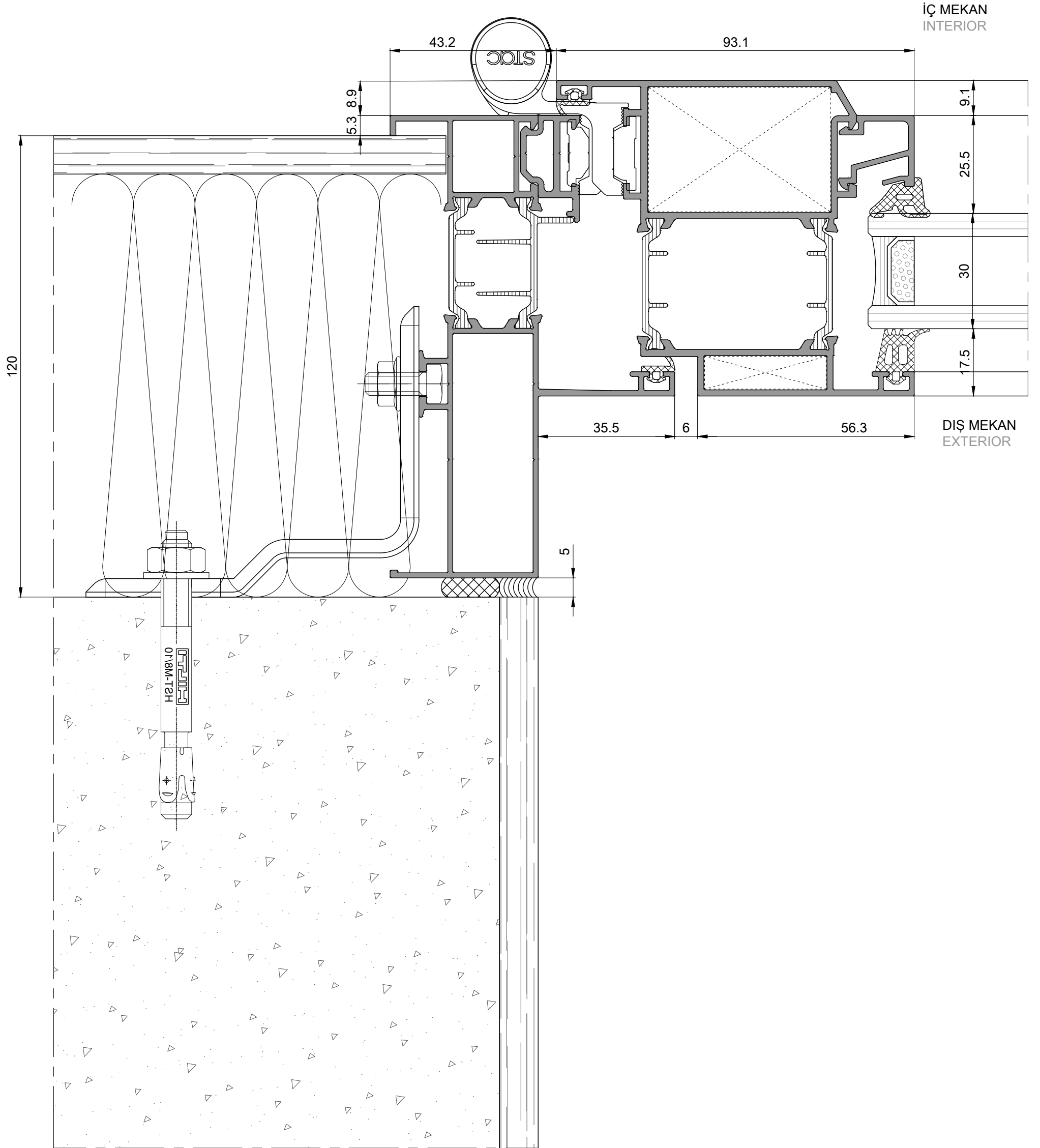
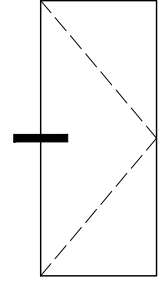

140mm YALITIMLI SOL YAN DETAY
140mm isolation with left side detail

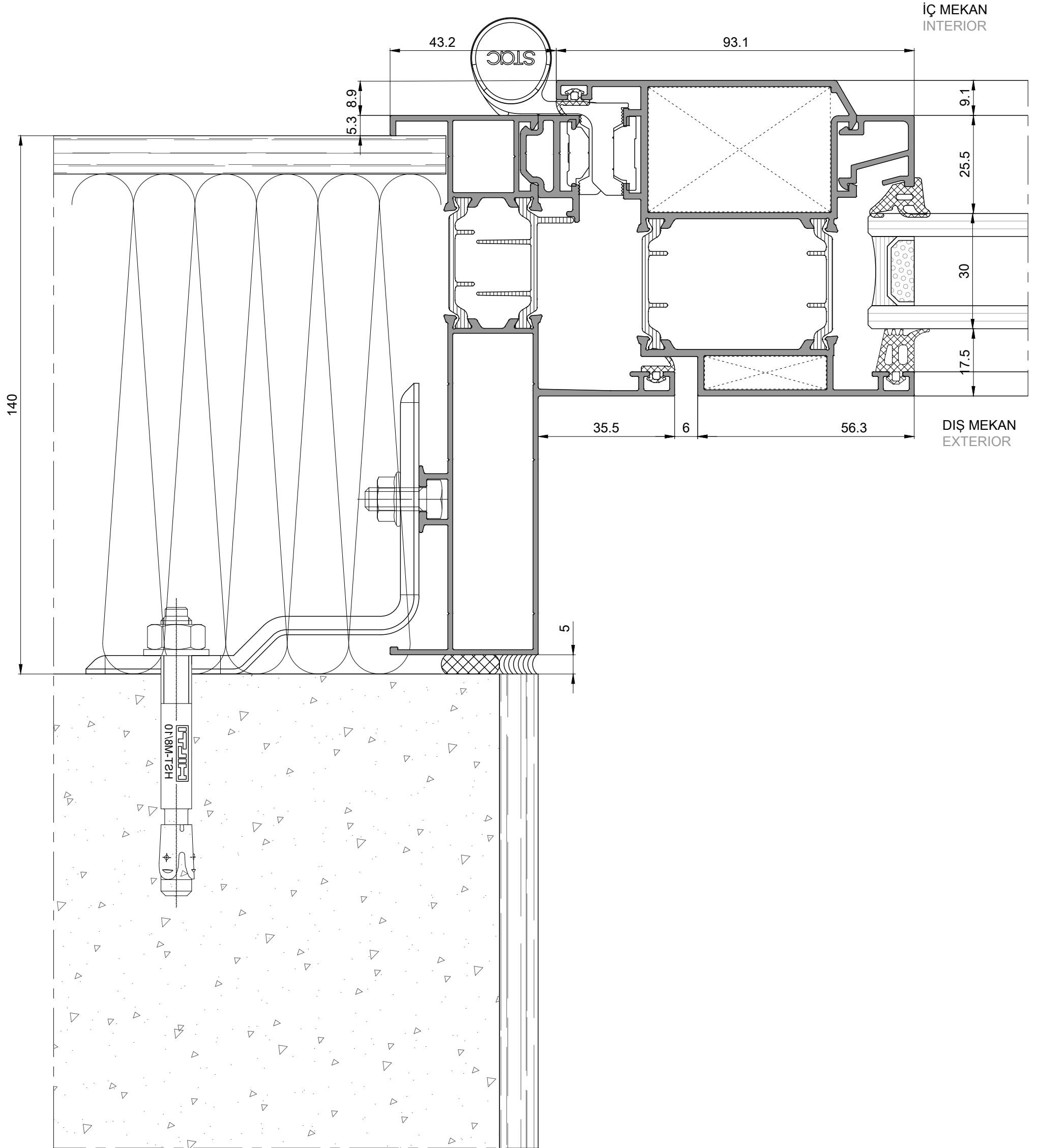
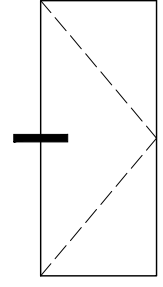

160mm YALITIMLI SOL YAN DETAY
160mm isolation with left side detail

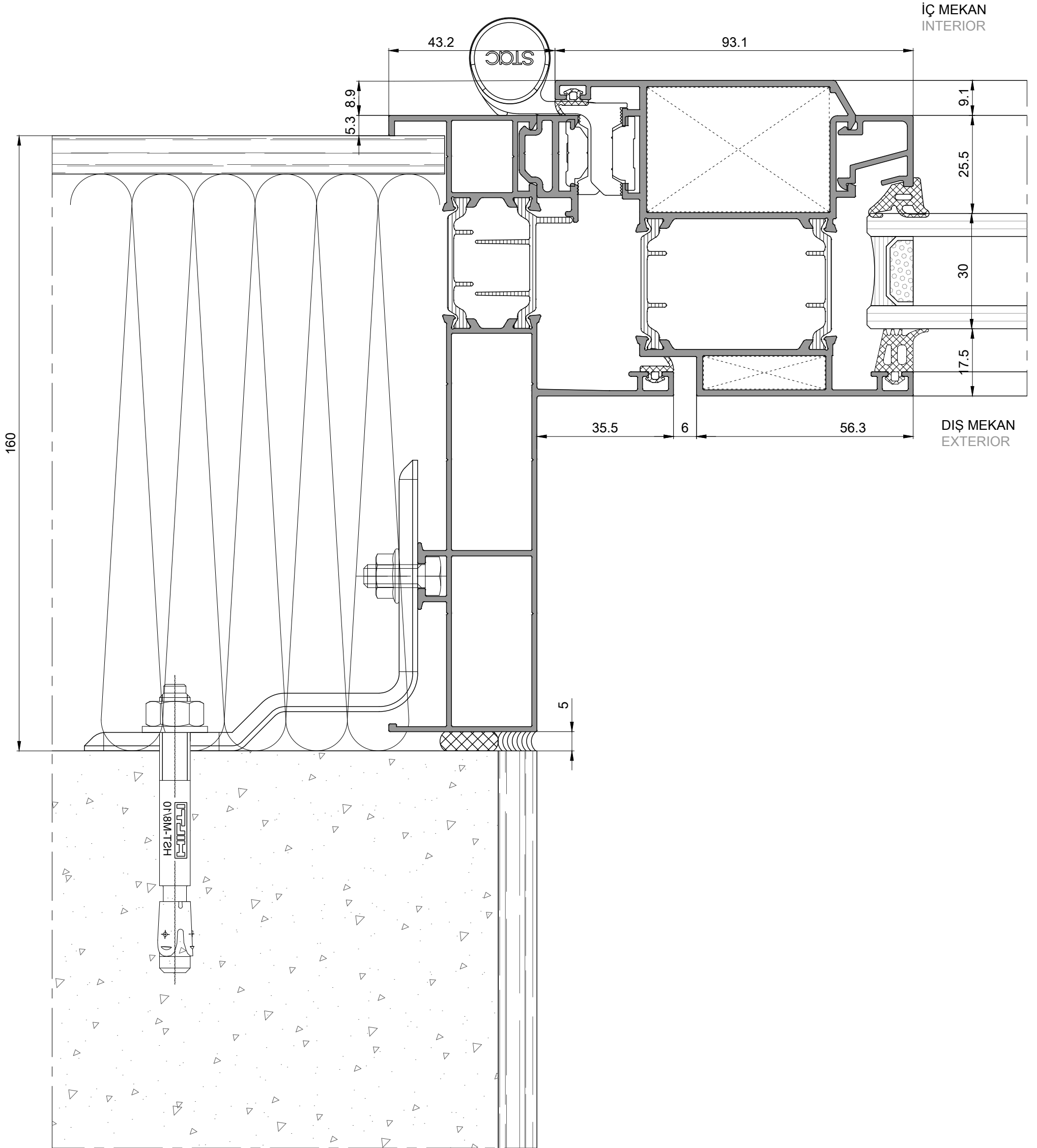
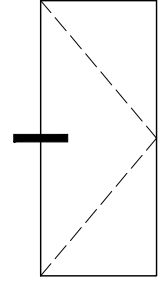

180mm YALITIMLI SOL YAN DETAY
180mm isolation with left side detail

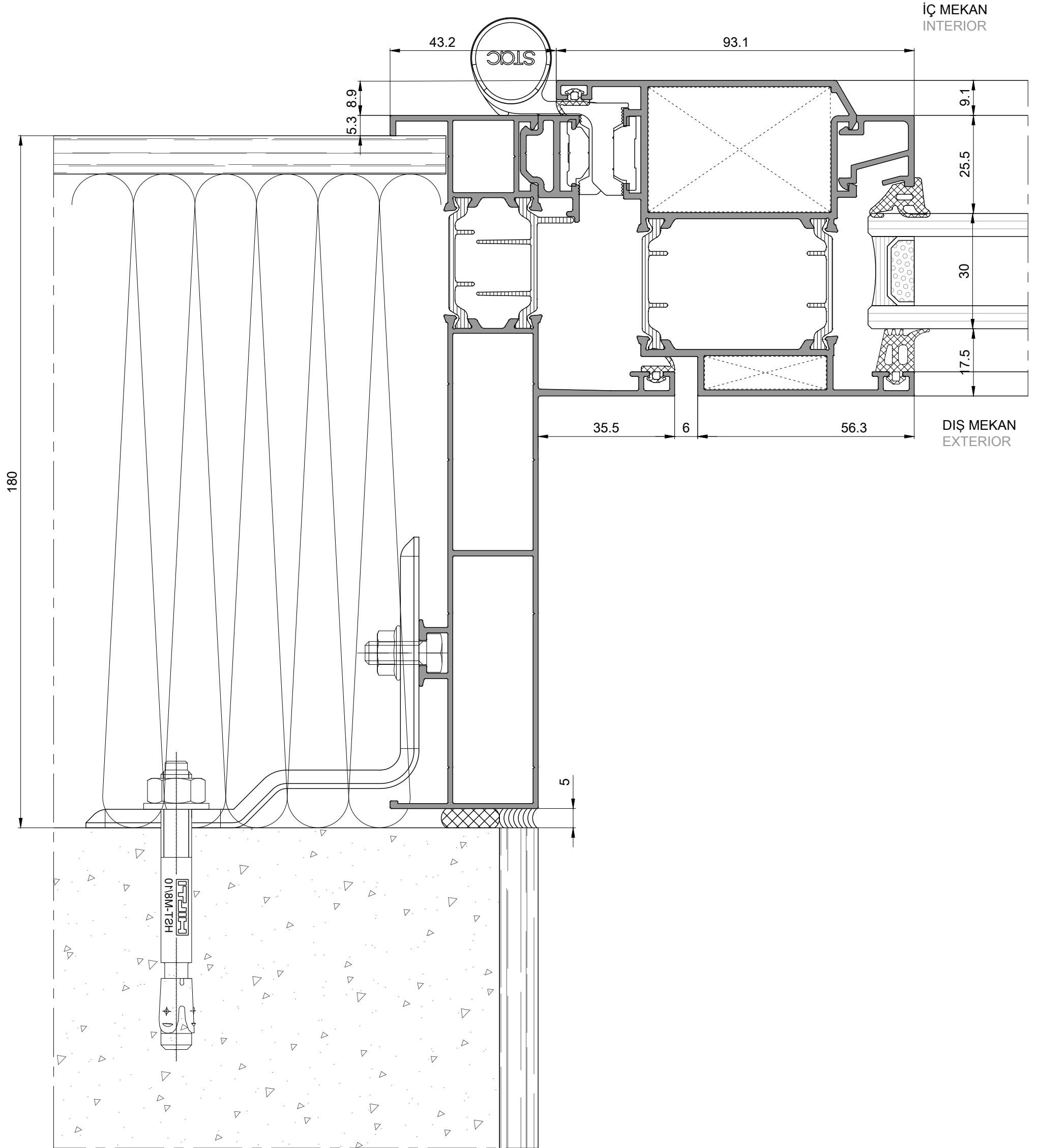
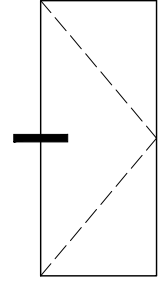

200mm YALITIMLI SOL YAN DETAY
200mm isolation with left side detail

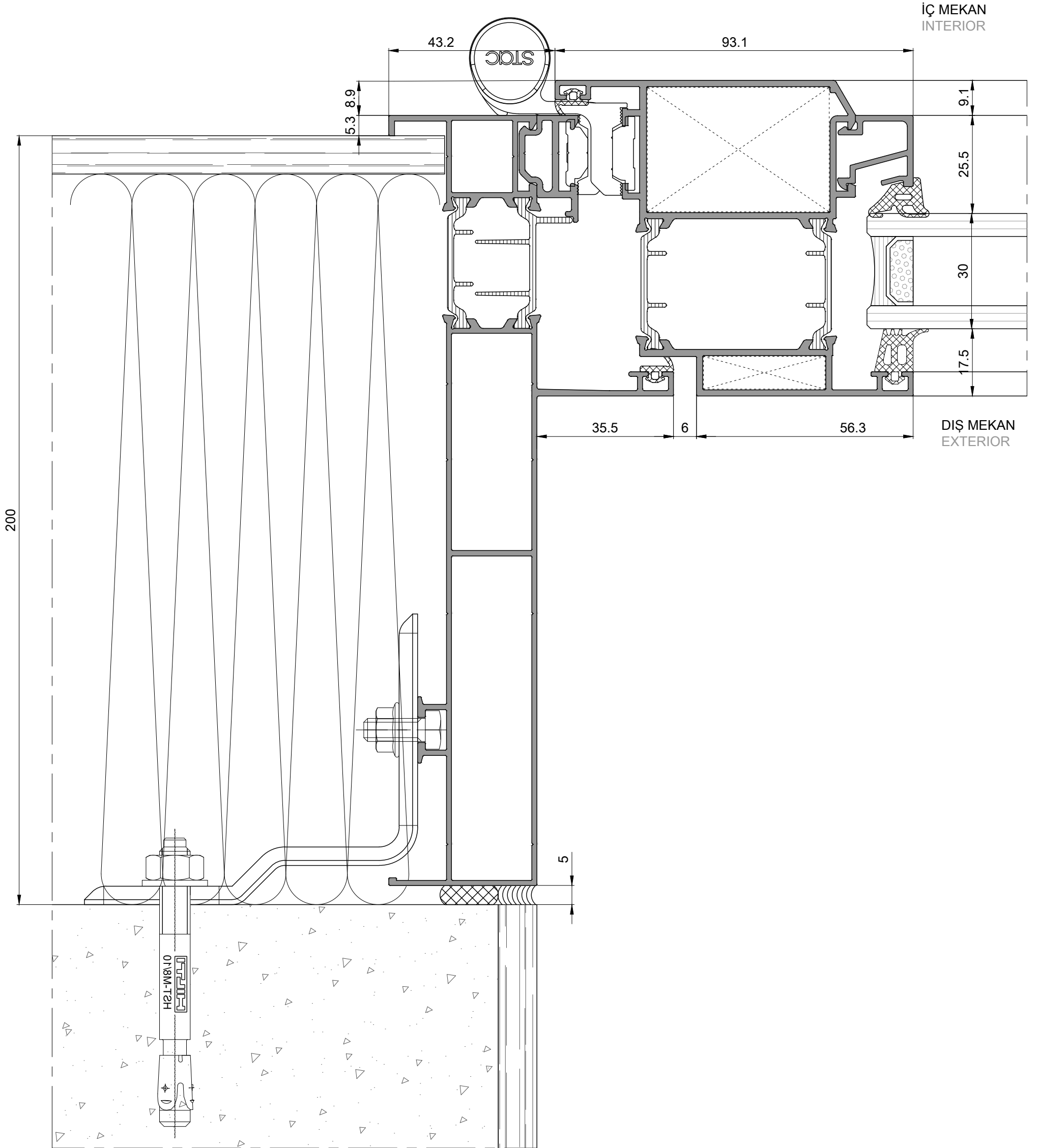
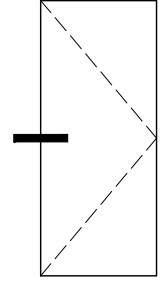

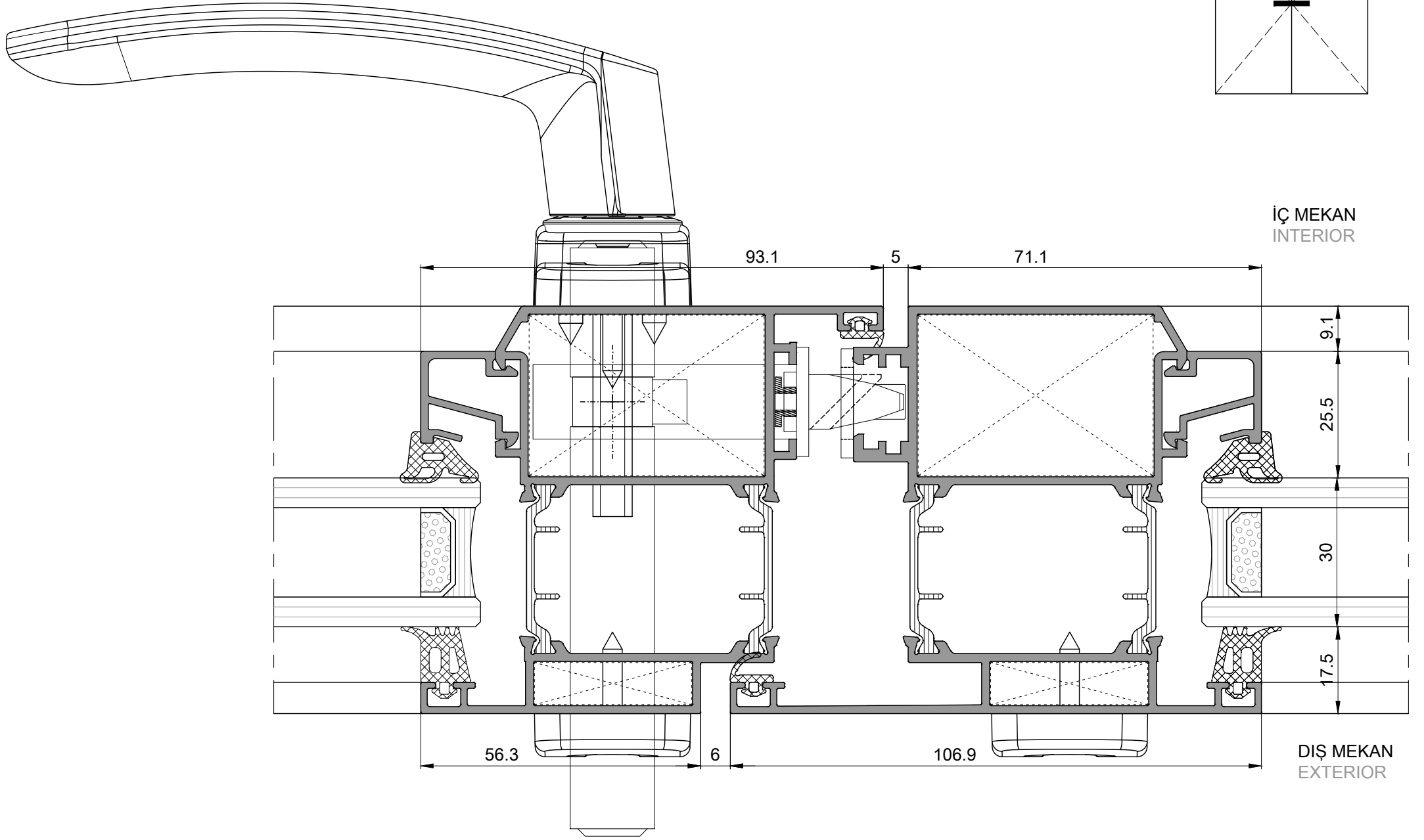
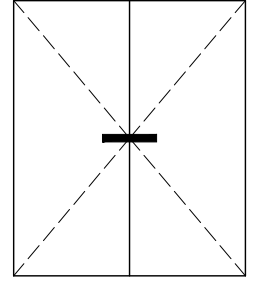

100mm YALITIMLI SAG YAN DETAY
100mm isolation with right side detail

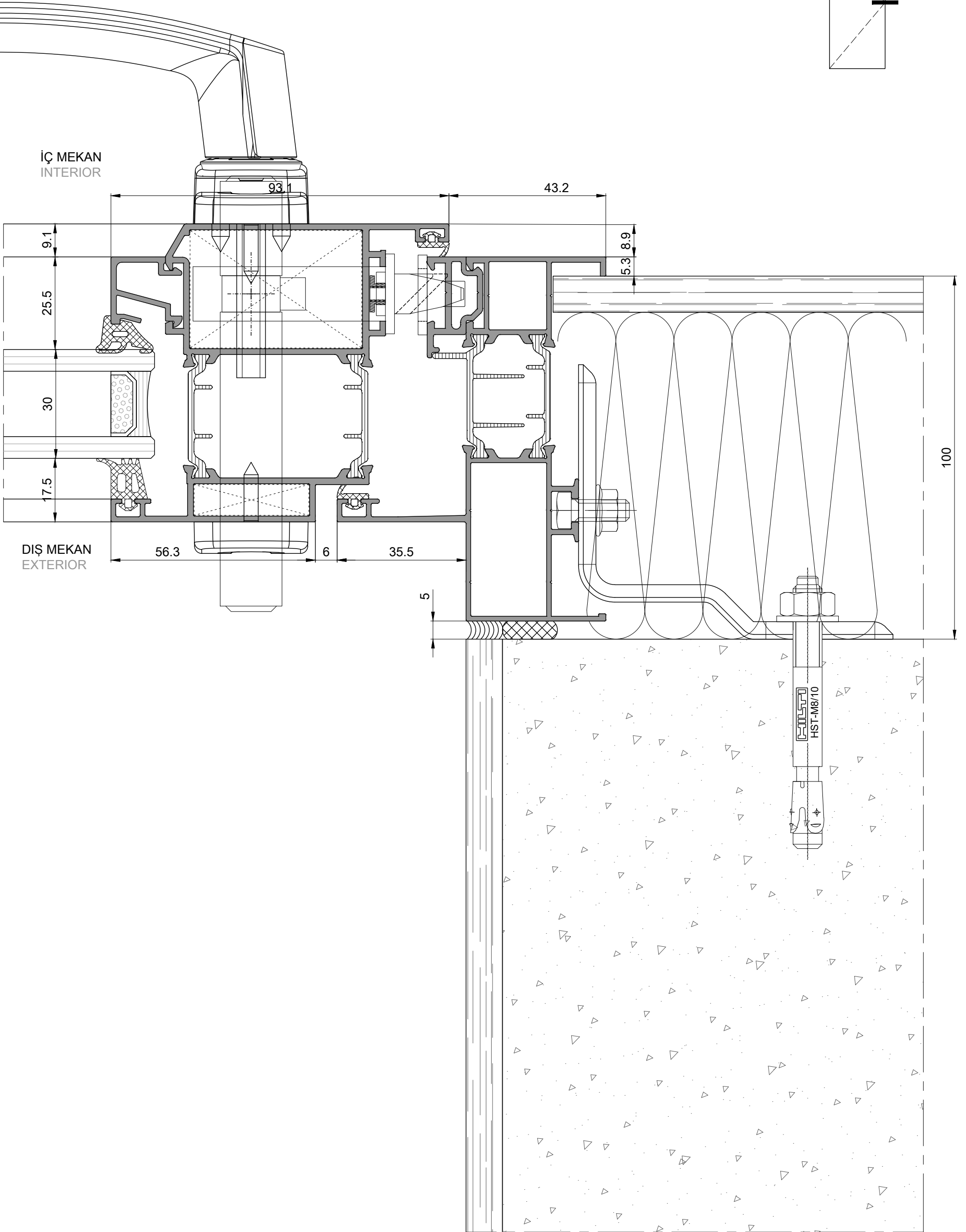
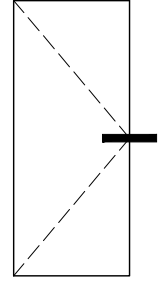

120mm YALITIMLI SAG YAN DETAY
120mm isolation with right side detail

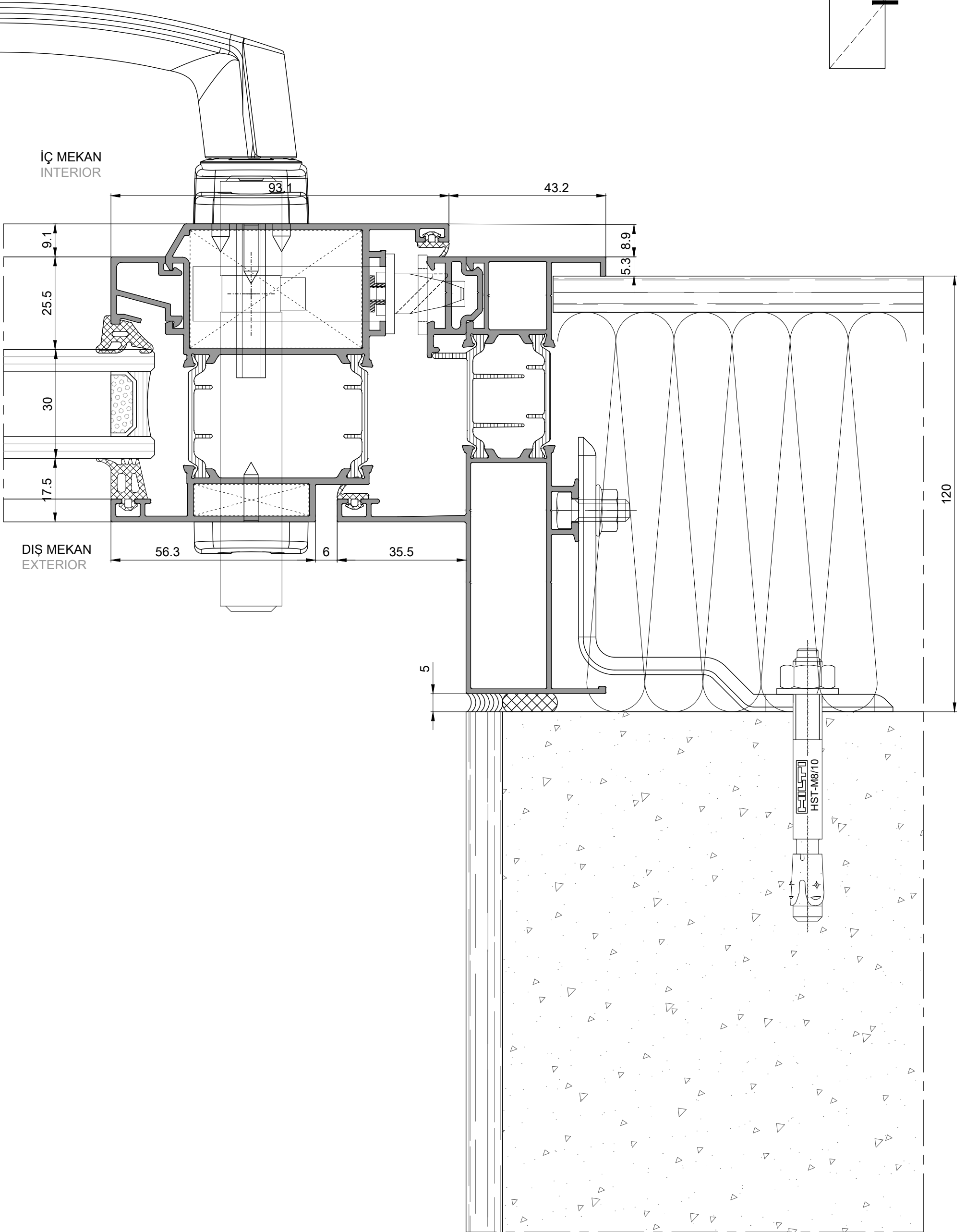
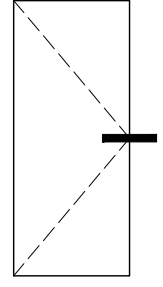

140mm YALITIMLI SAG YAN DETAY
140mm isolation with right side detail

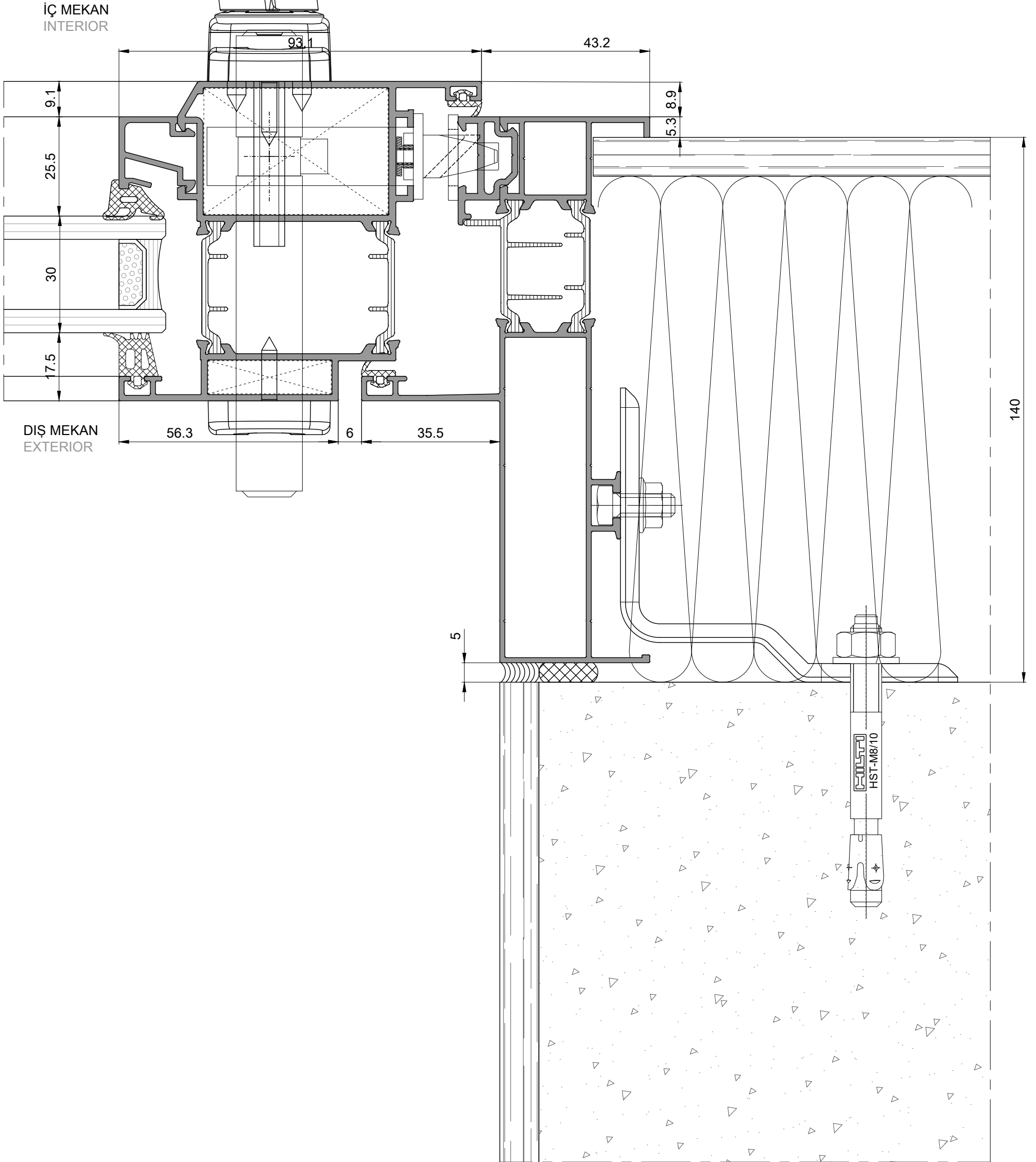
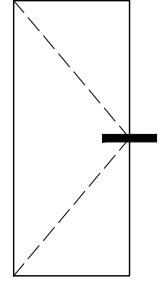

160mm YALITIMLI SAG YAN DETAY
160mm isolation with right side detail

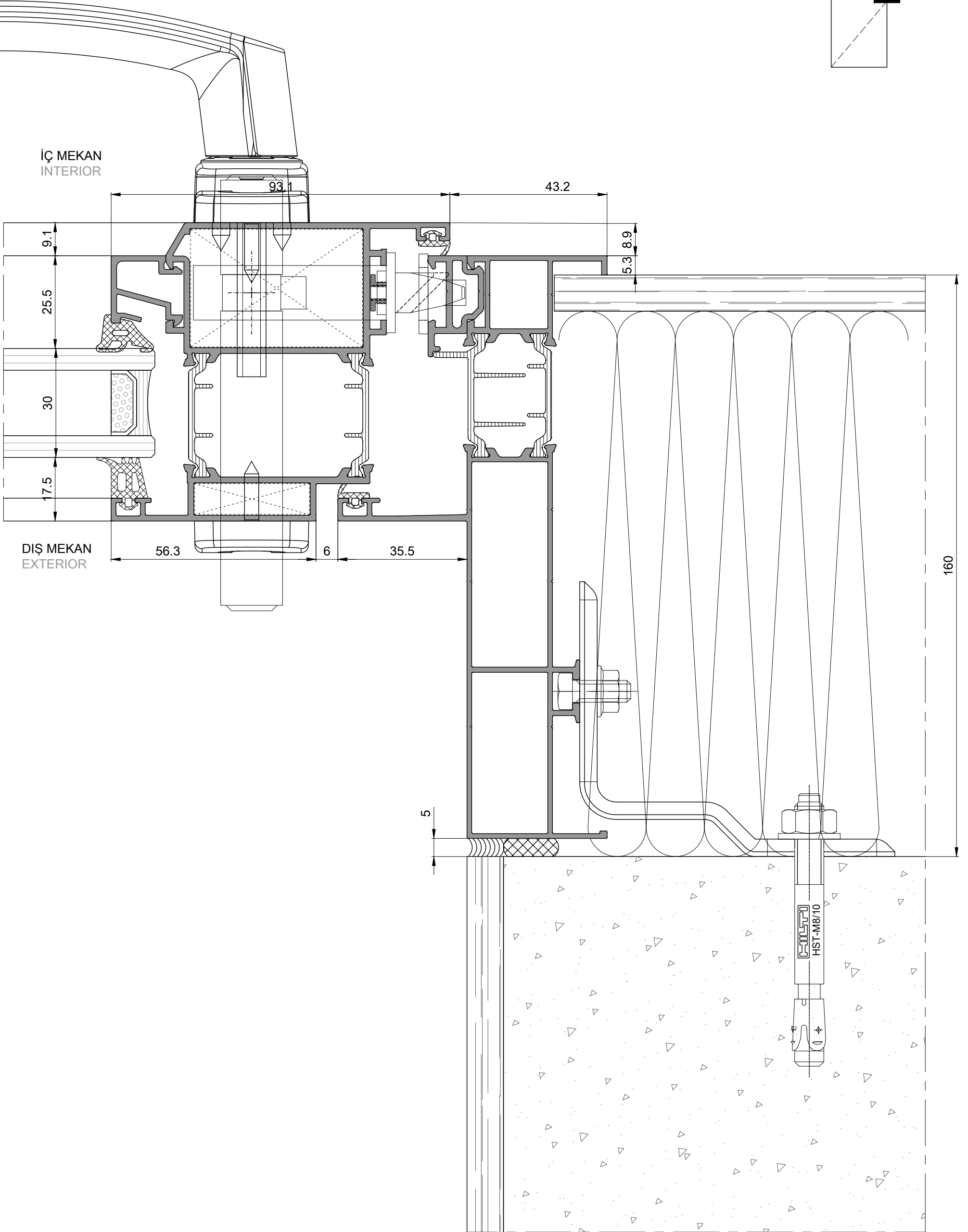
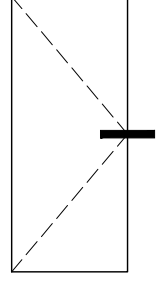

180mm YALITIMLI SAG YAN DETAY
180mm isolation with right side detail

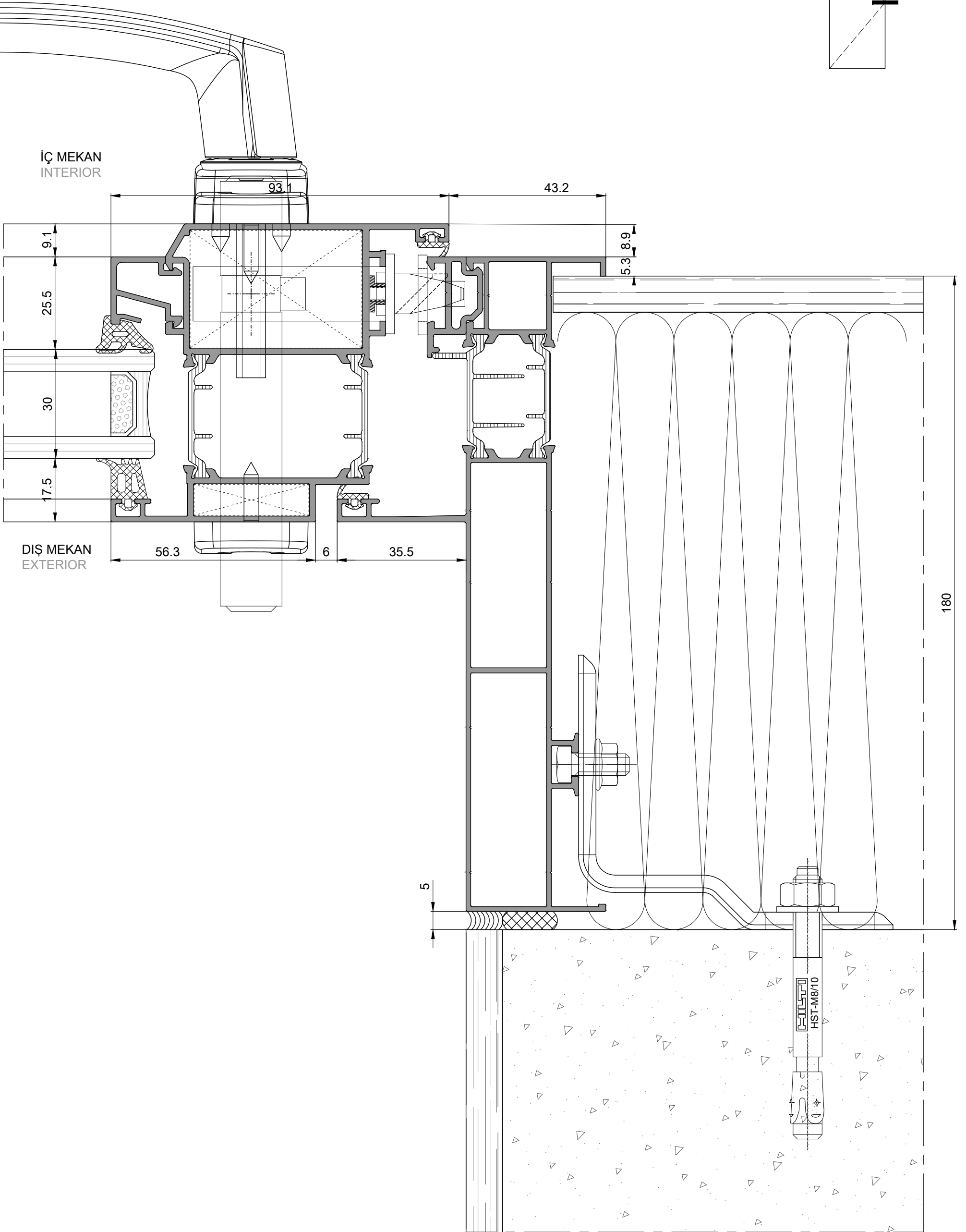
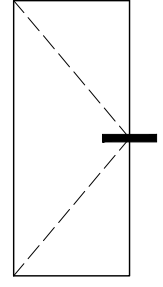

200mm YALITIMLI SAG YAN DETAY
200mm isolation with right side detail

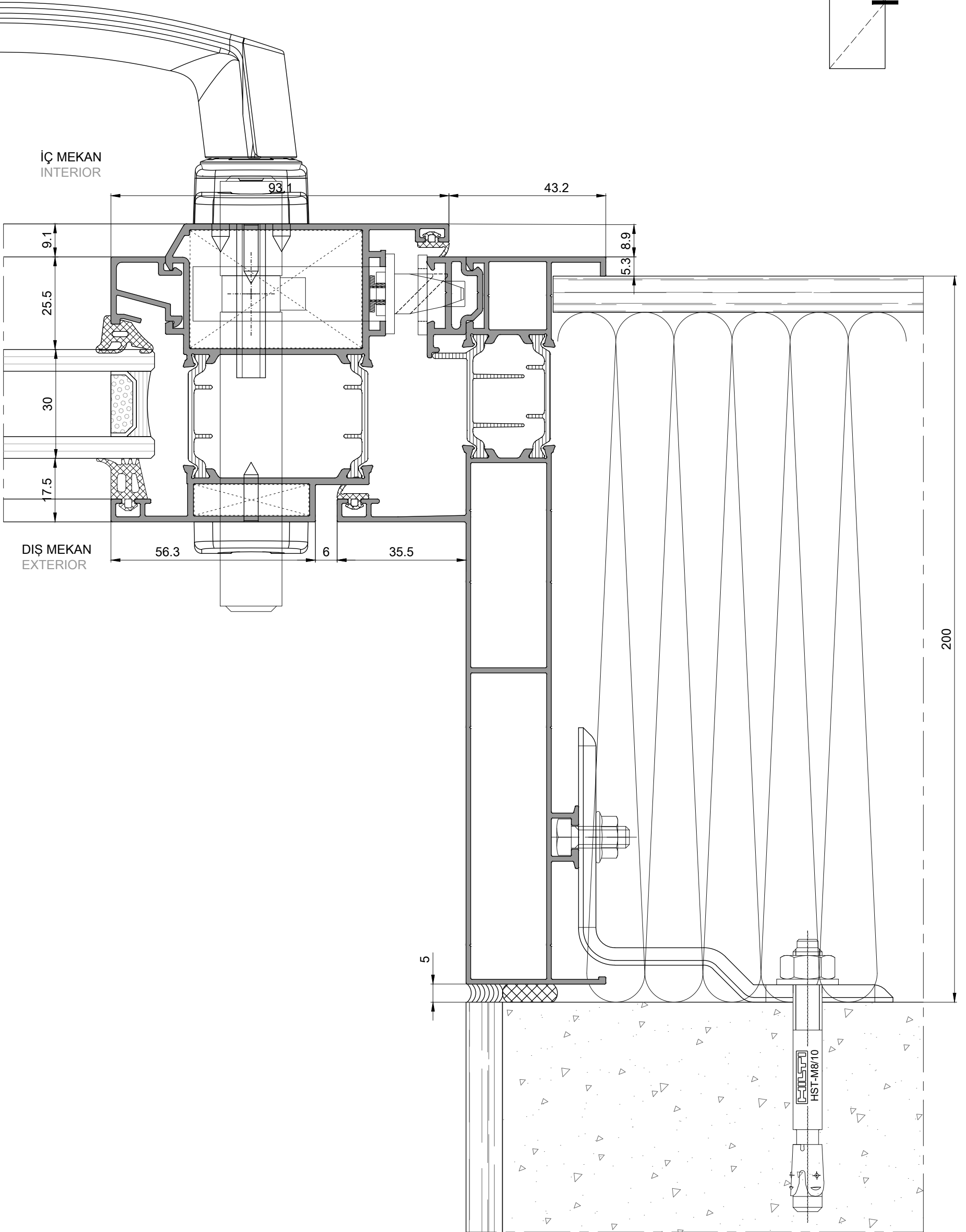
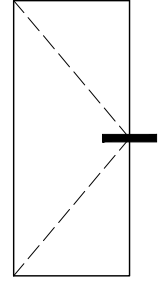

100mm YALITIMLI ÜST DETAY
100mm isolation with top side detail

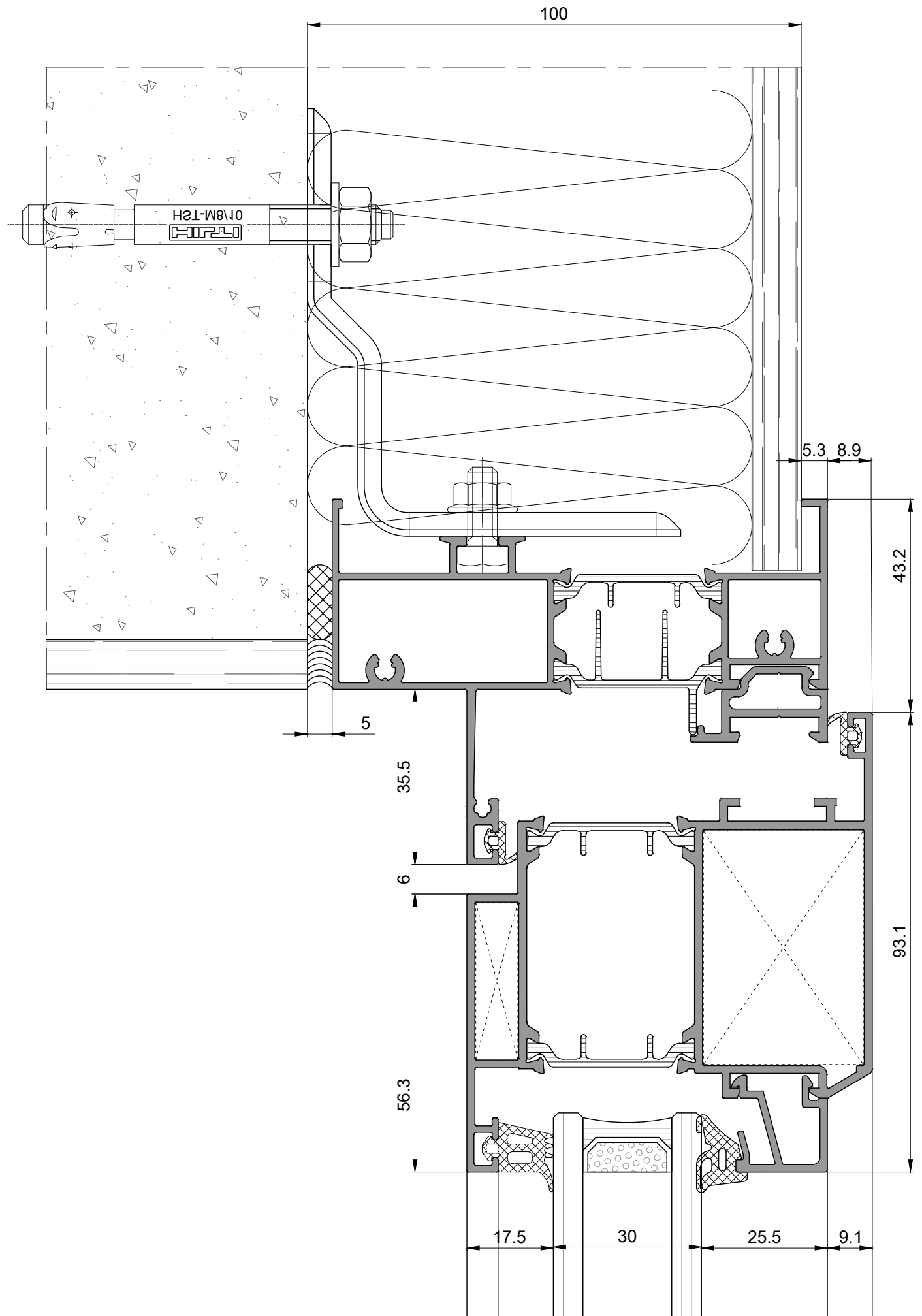
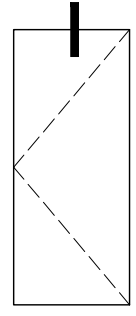

120mm YALITIMLI ÜST DETAY
120mm isolation with top side detail

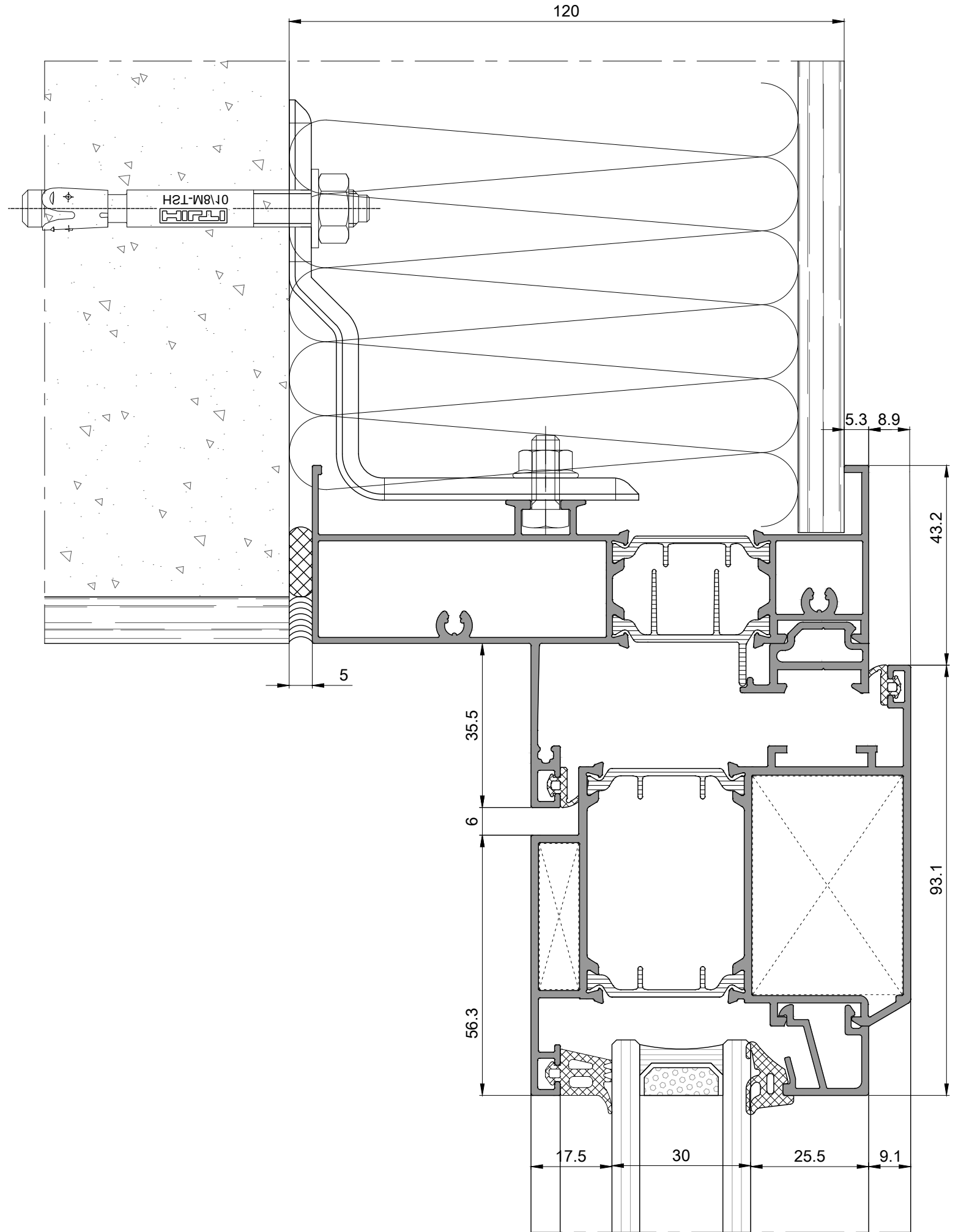
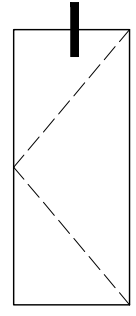

140mm YALITIMLI ÜST DETAY
140mm isolation with top side detail

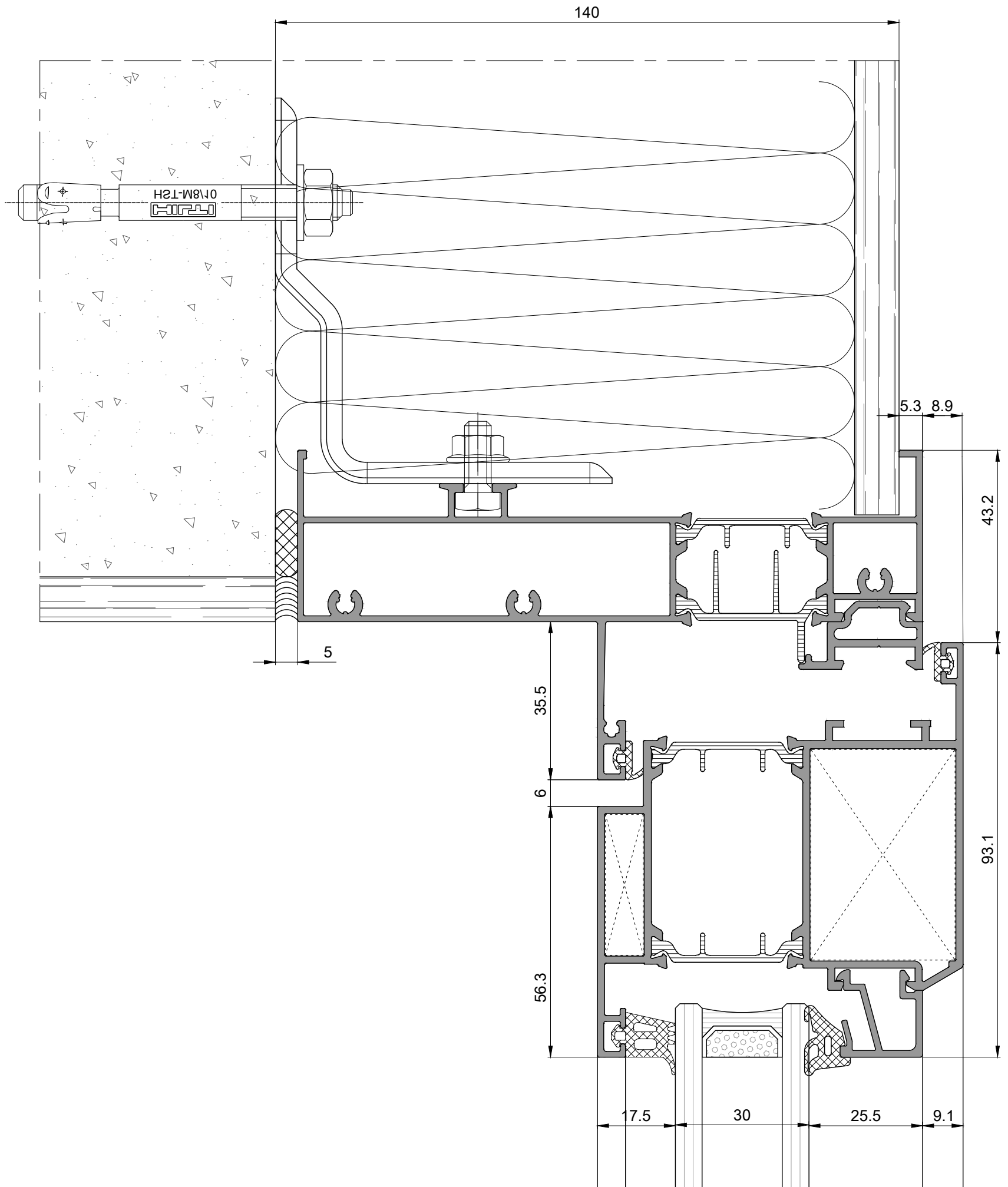
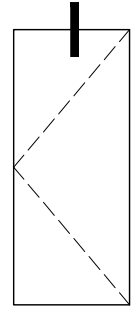

160mm YALITIMLI ÜST DETAY
160mm isolation with top side detail

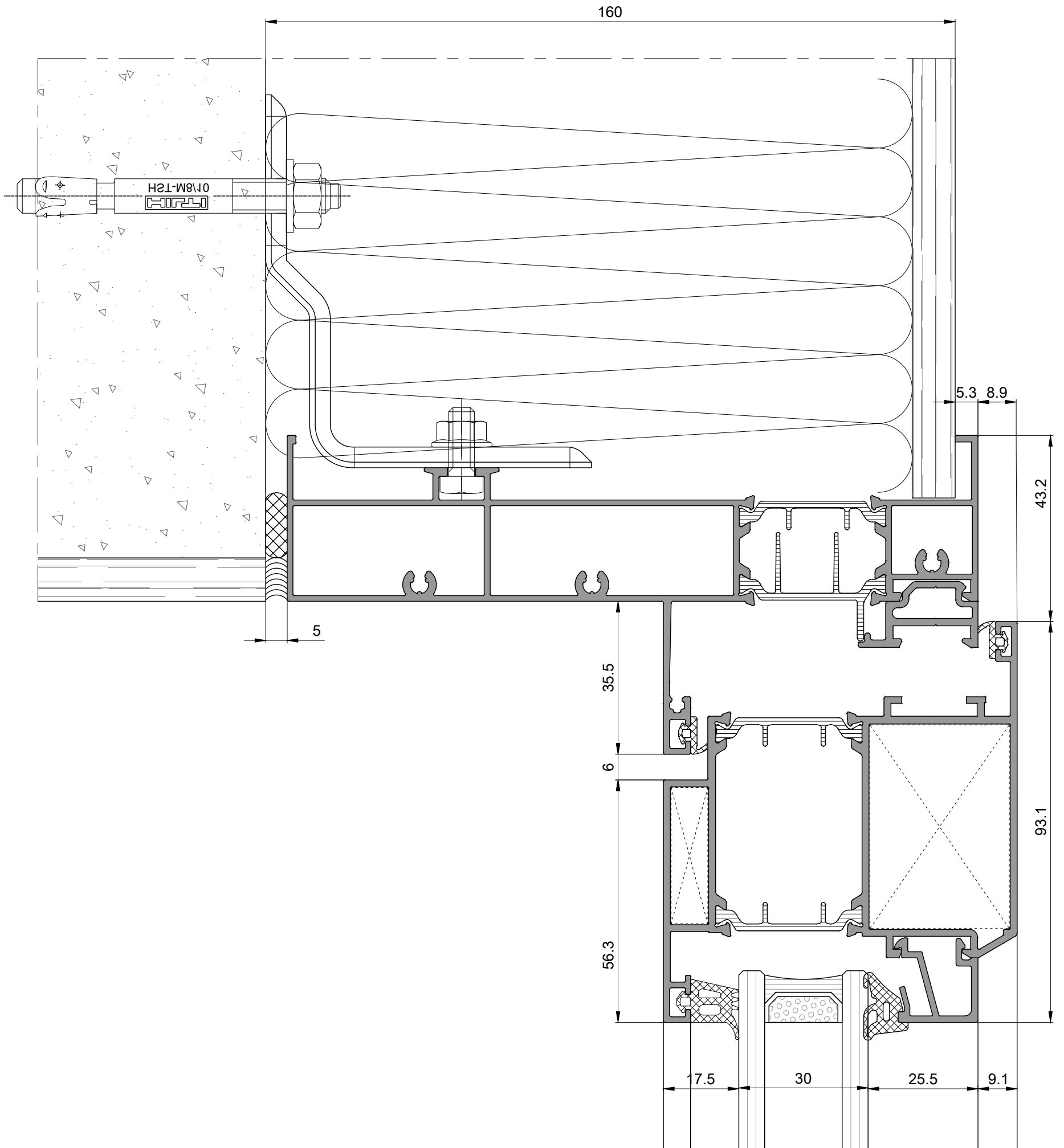
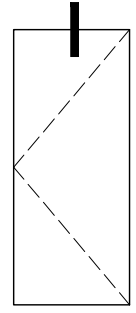

180mm YALITIMLI ÜST DETAY
180mm isolation with top side detail

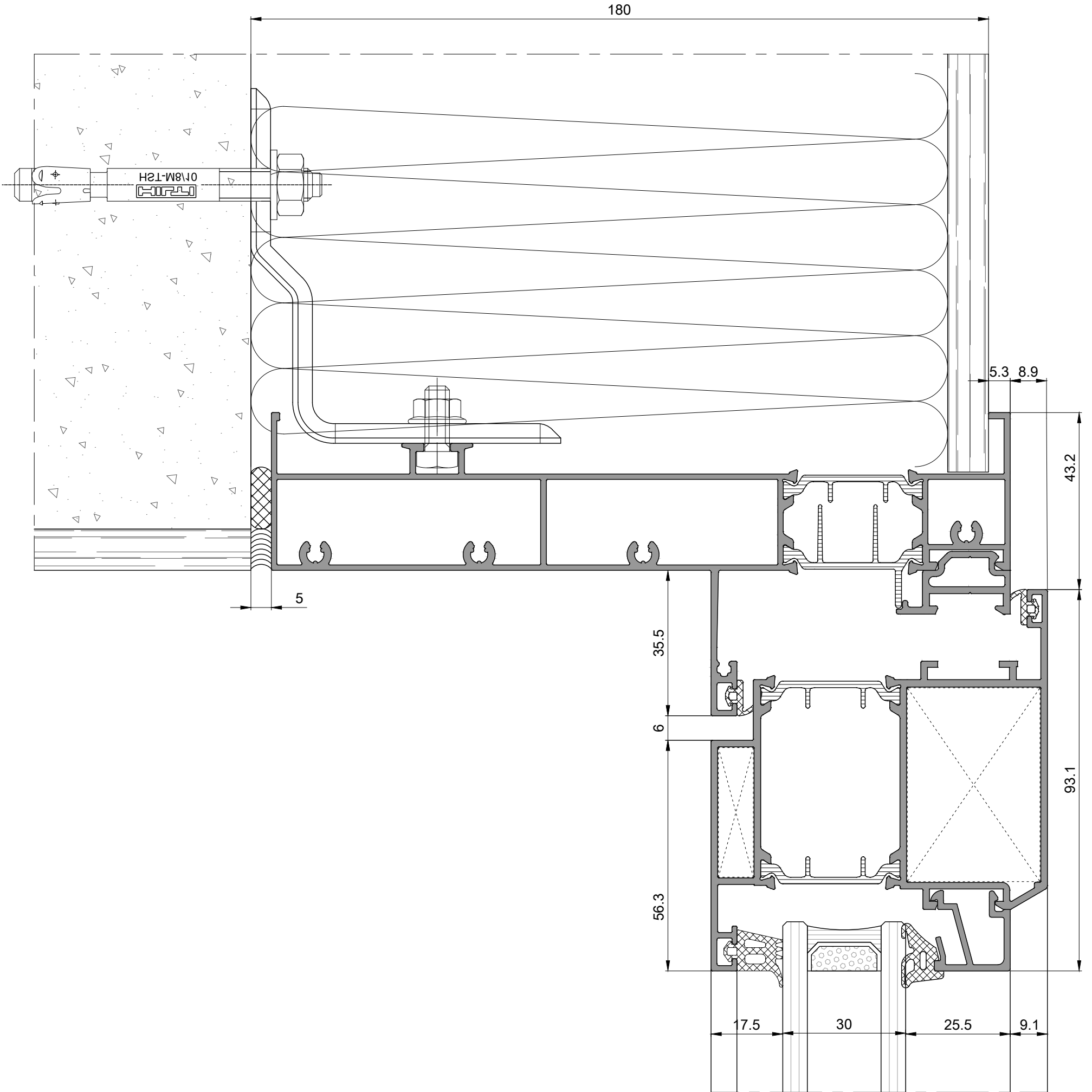
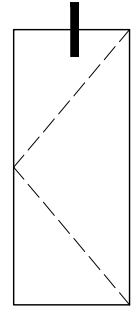

200mm YALITIMLI ÜST DETAY
200mm isolation with top side detail

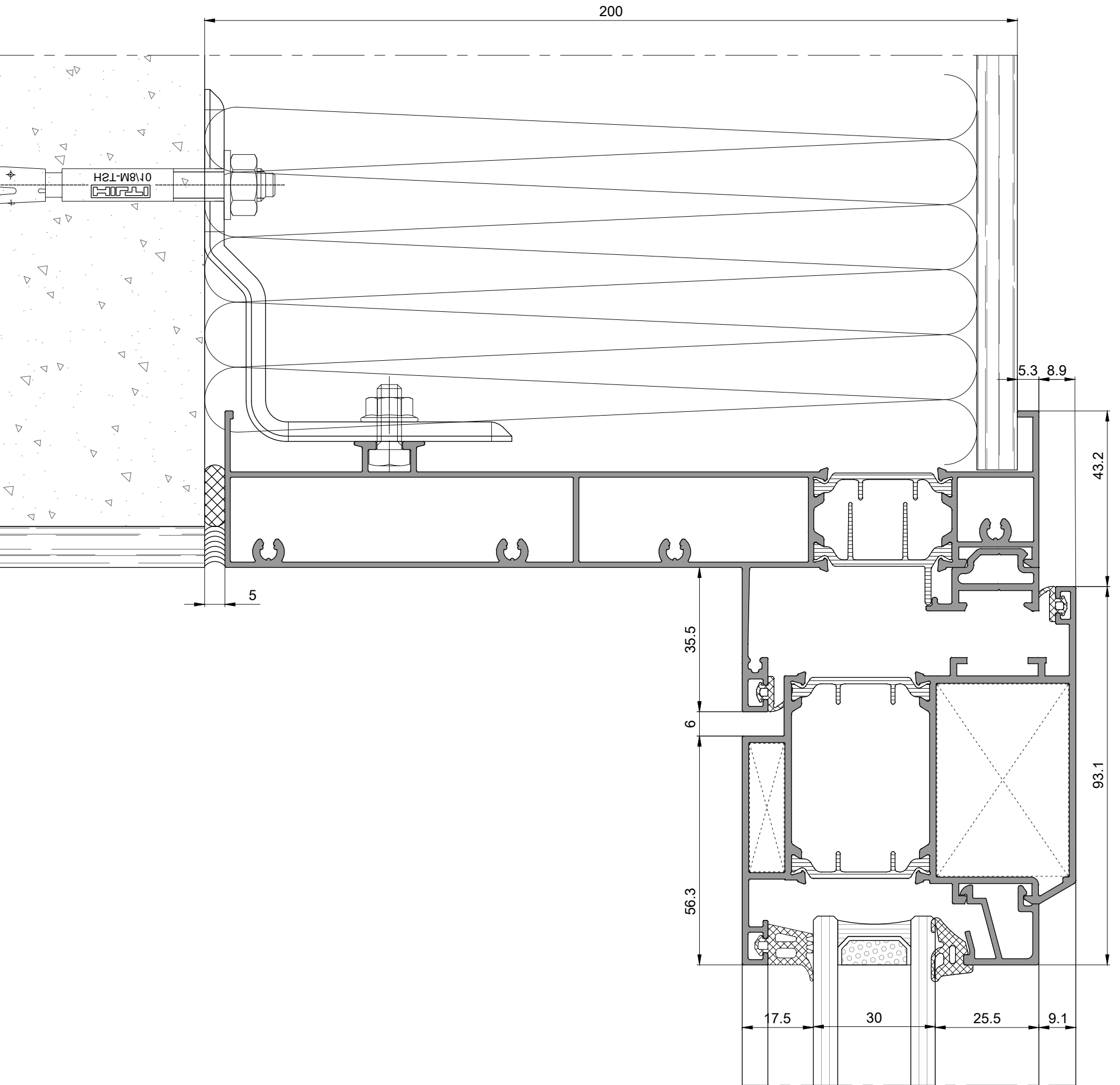
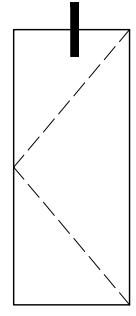

KAPI ALT EŞİK DETAY
Door bottom side threshold detail

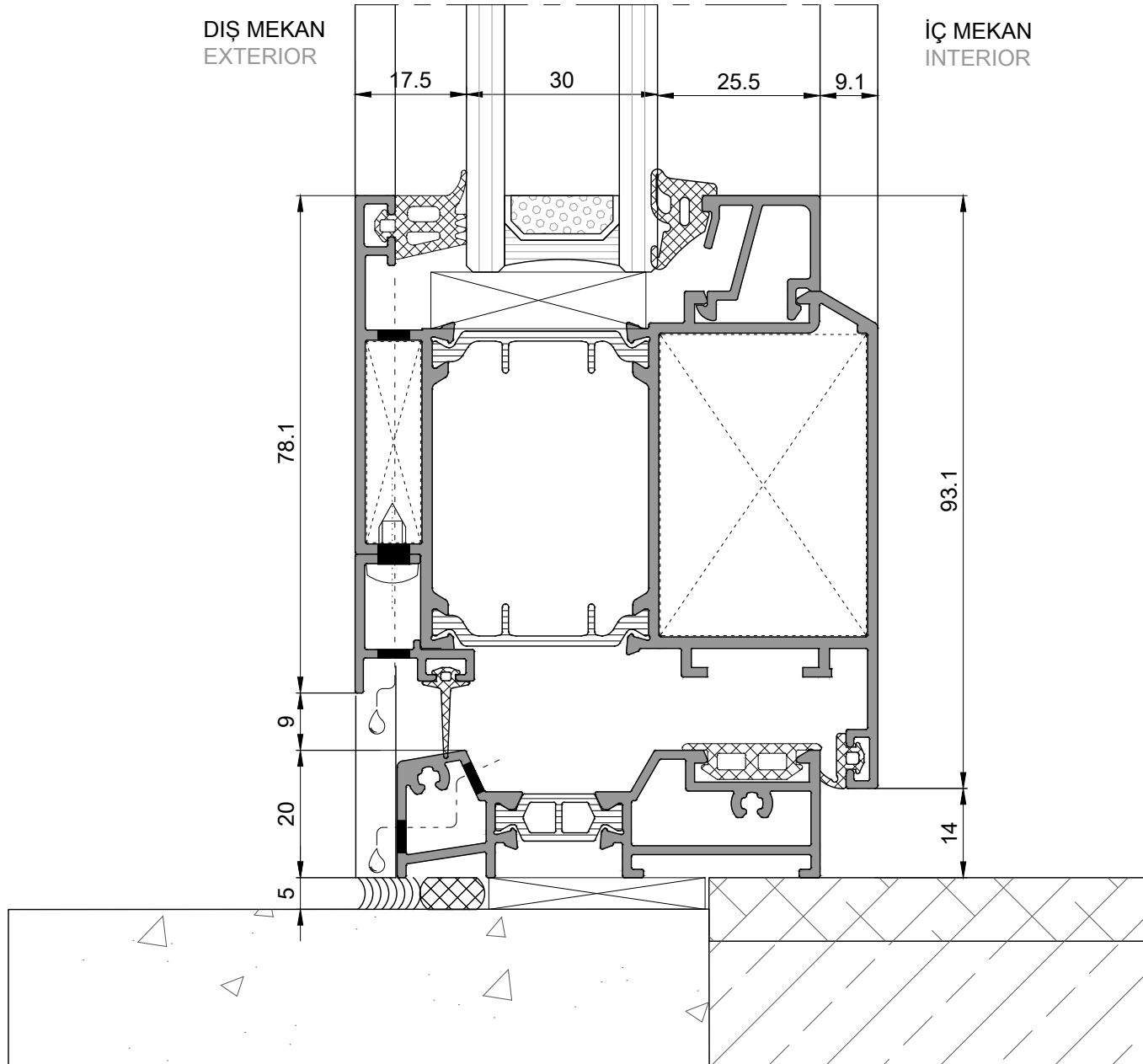
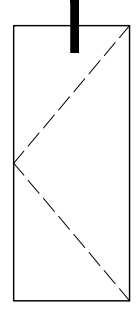

ALFA

GİZLİ KANATLI PENCERE ve KAPI SİSTEMİ CONCEALED SASH WINDOW and DOOR SYSTEM

GİRİŞ KAPISI ve SABİT BÖLÜMLÜ PENCERE PRENSİP SİSTEM DETAYLARI PRINCIPAL SECTIONS for ENTRANCE DOOR with FIXED GLASS WINDOW SYSTEM

100mm YALITIMLI SOL YAN DETAY
100mm isolation with left side detail

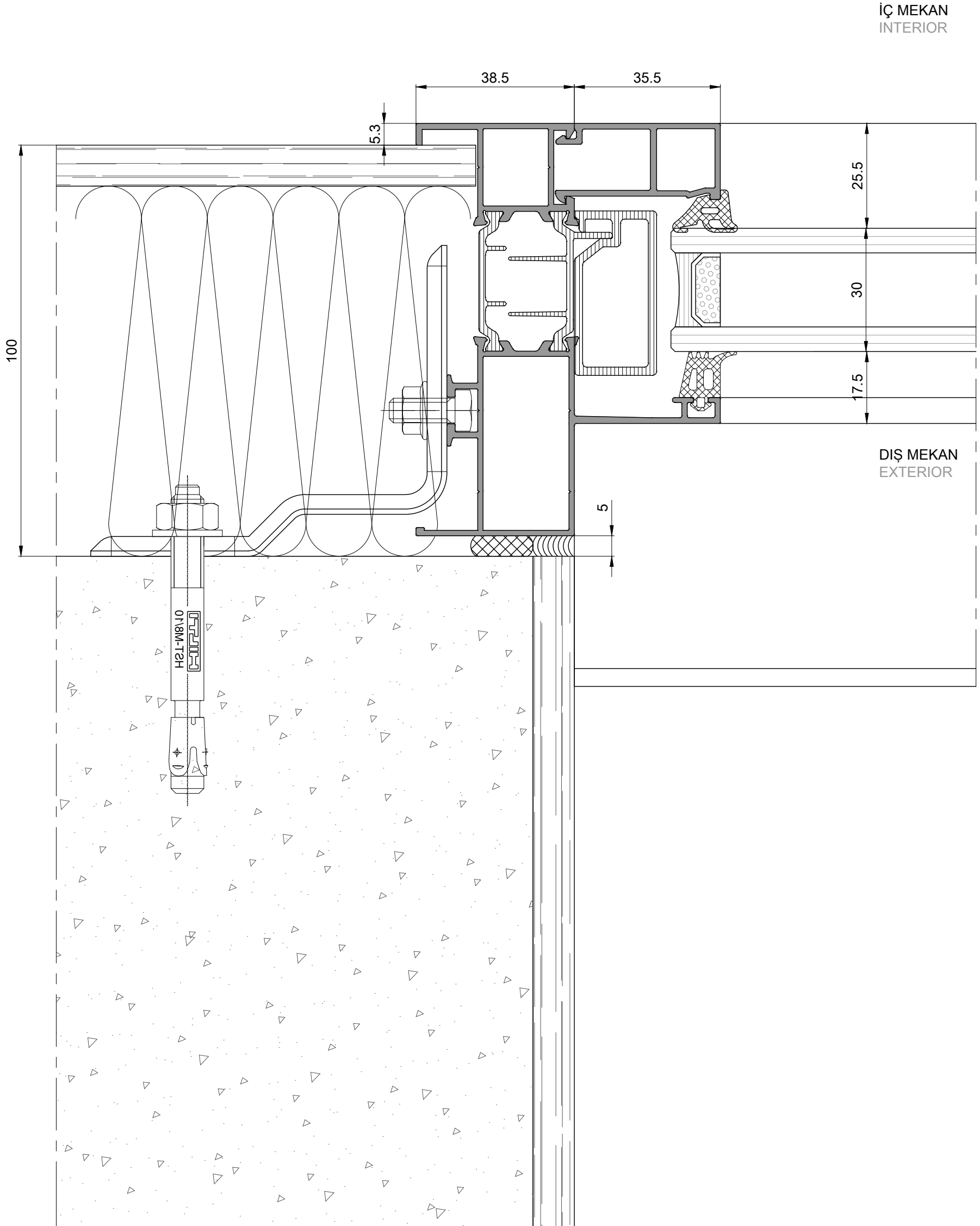
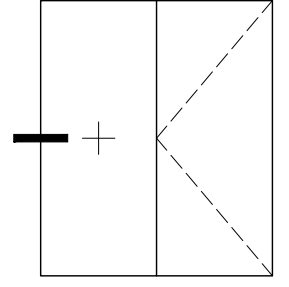

120mm YALITIMLI SOL YAN DETAY
120mm isolation with left side detail

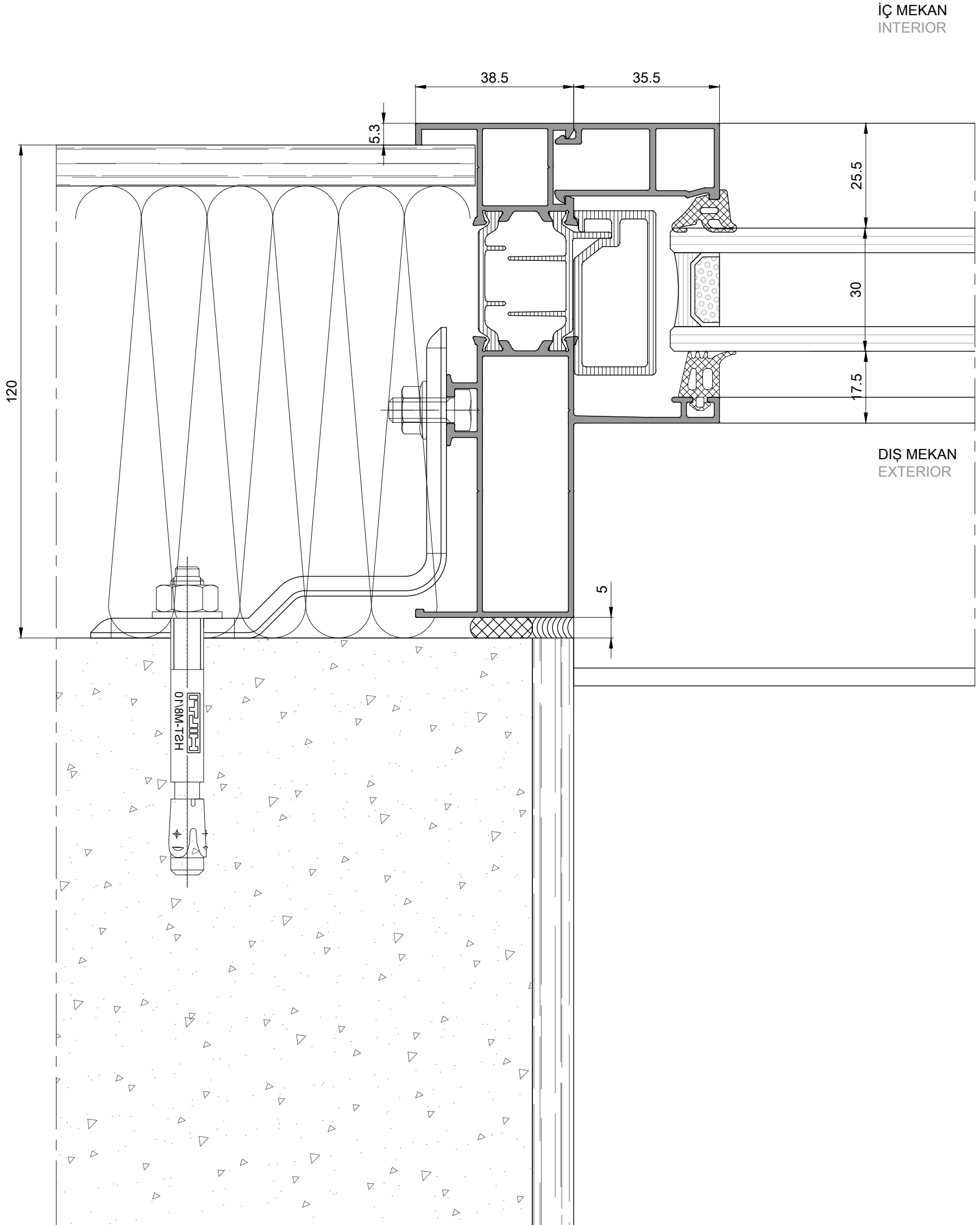
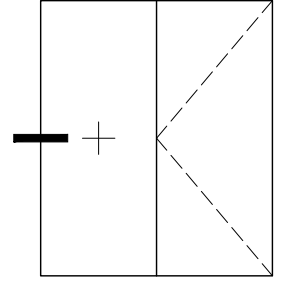

140mm YALITIMLI SOL YAN DETAY
140mm isolation with left side detail

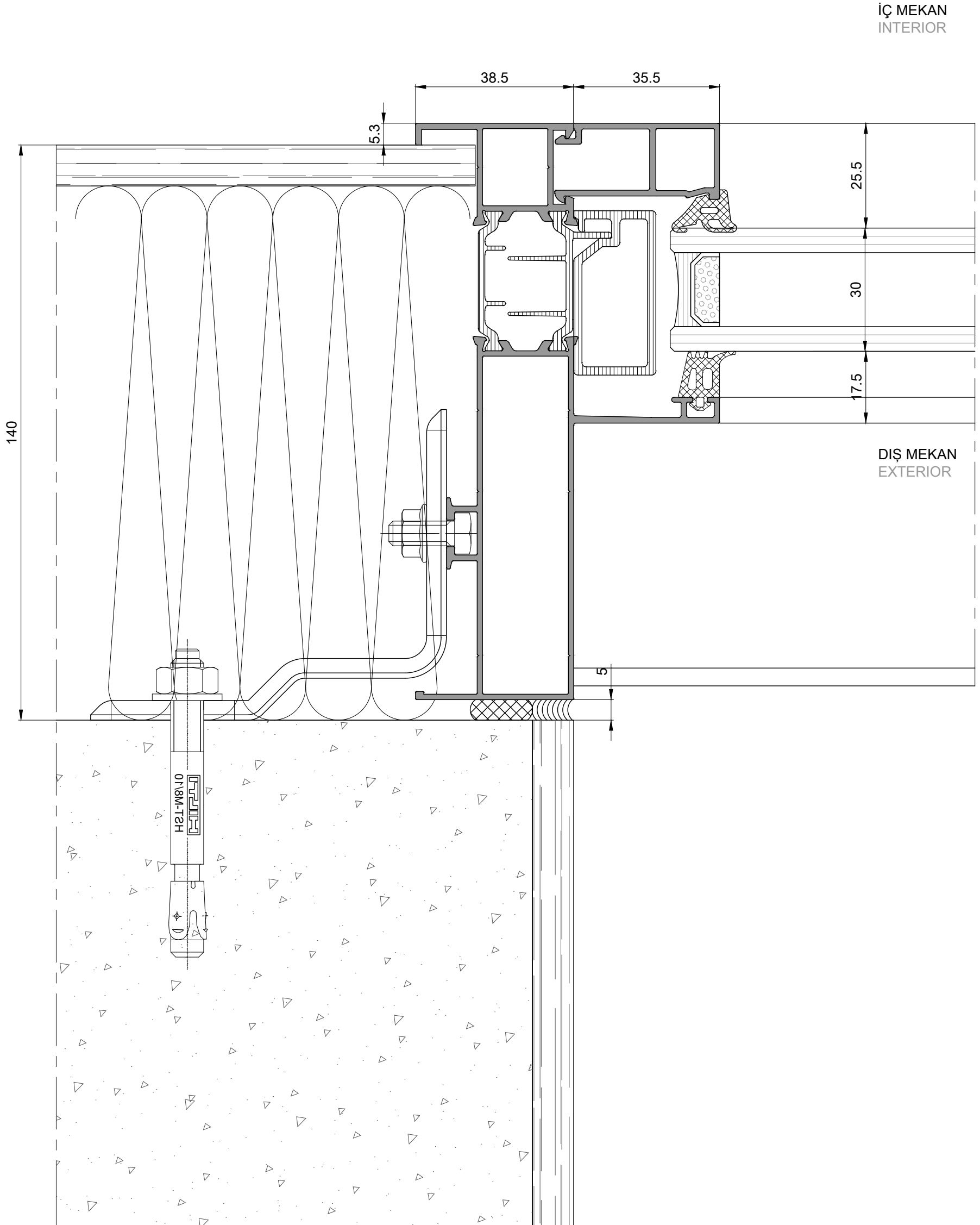
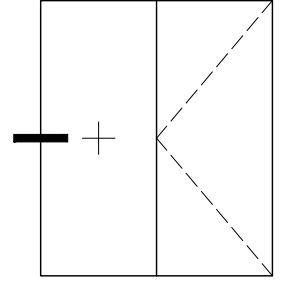

160mm YALITIMLI SOL YAN DETAY
160mm isolation with left side detail

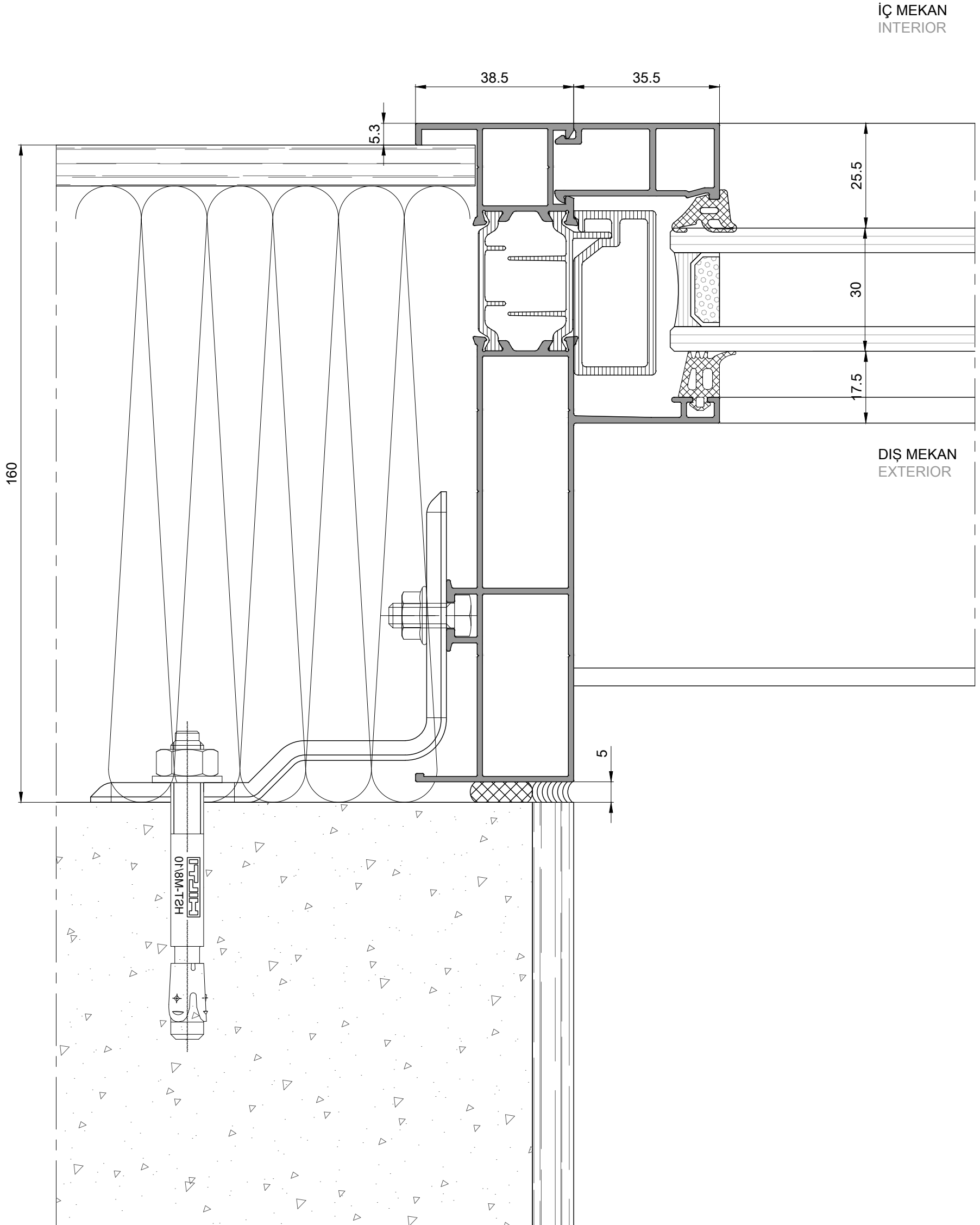
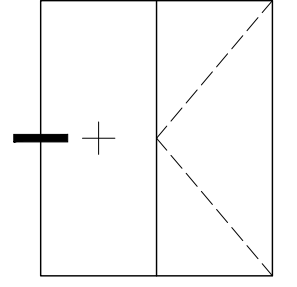

180mm YALITIMLI SOL YAN DETAY
180mm isolation with left side detail

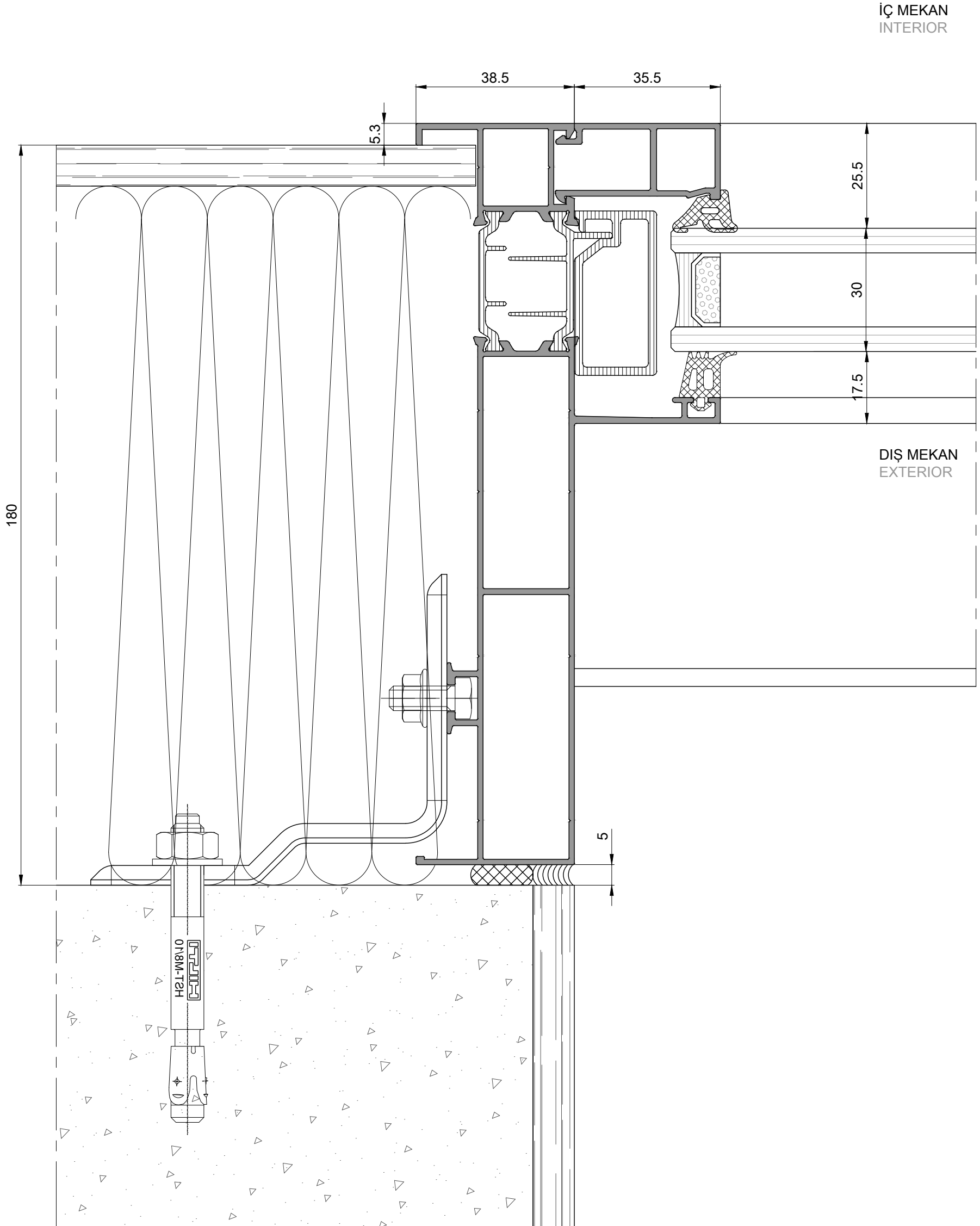
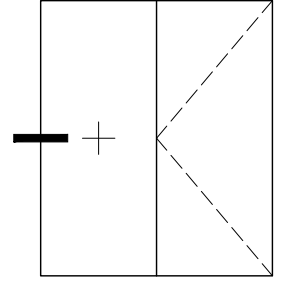

200mm YALITIMLI SOL YAN DETAY
200mm isolation with left side detail

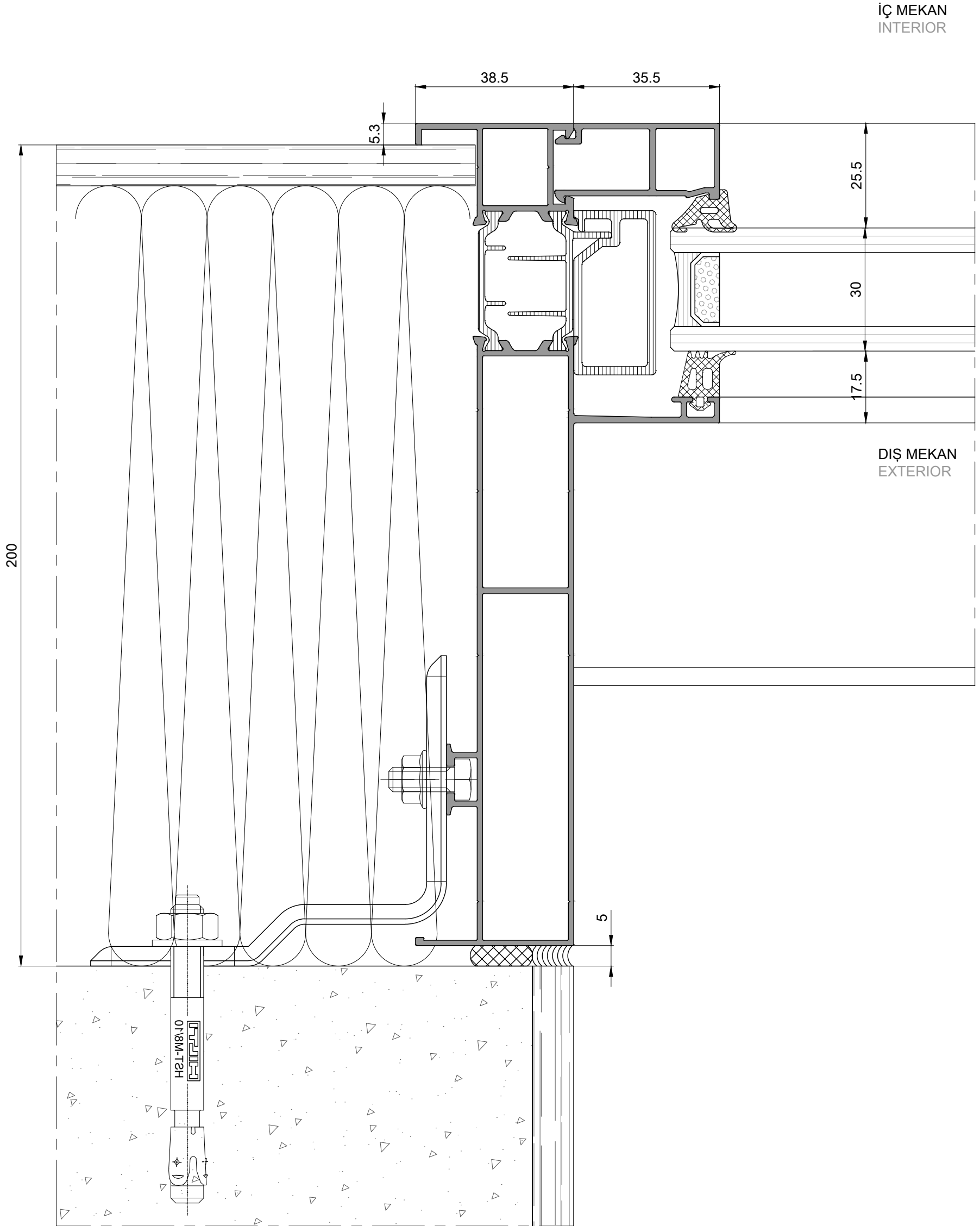
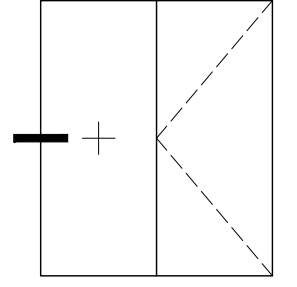

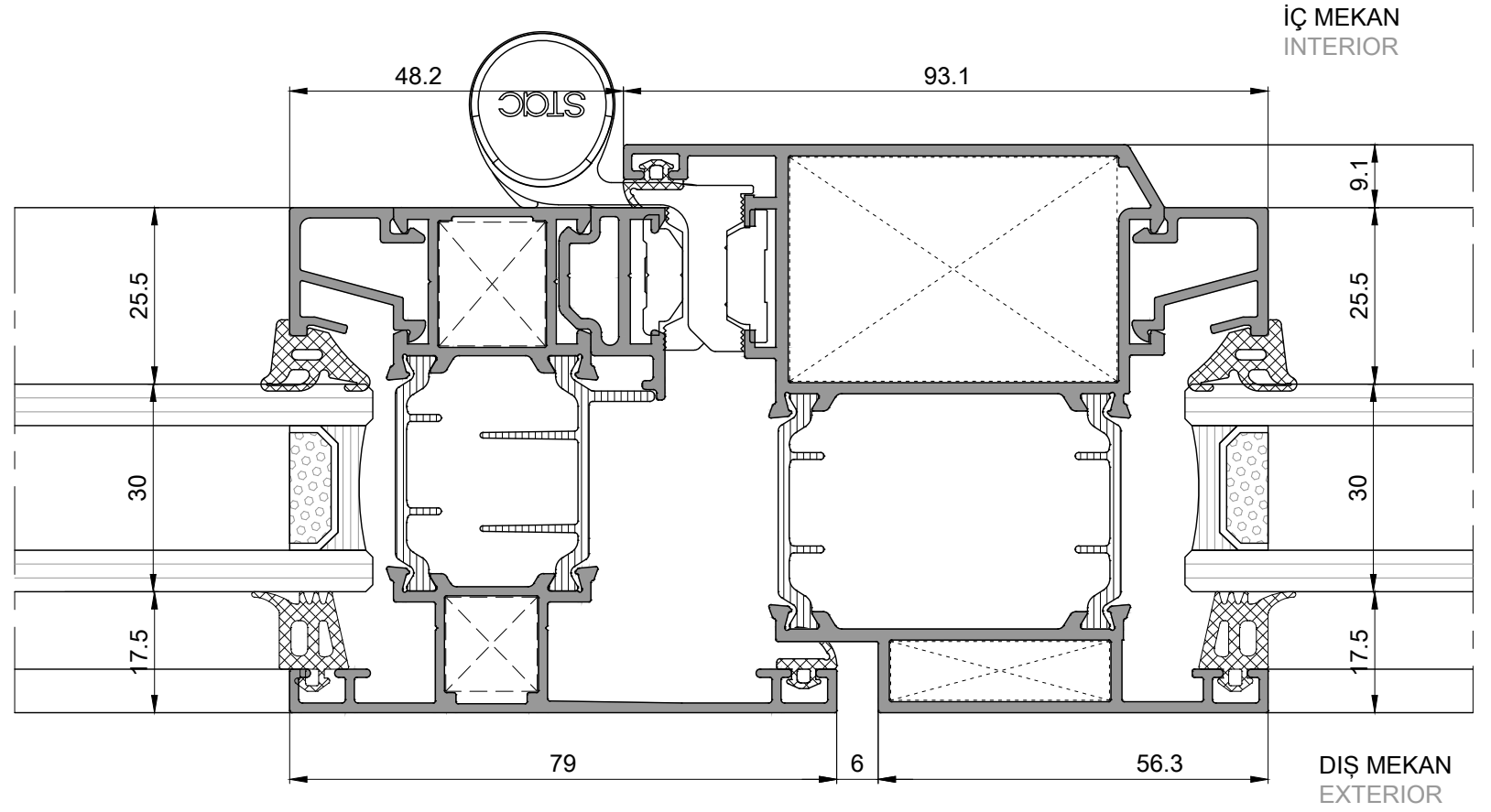
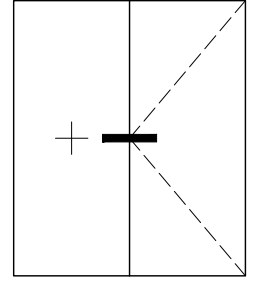

100mm YALITIMLI SAG YAN DETAY
100mm isolation with right side detail

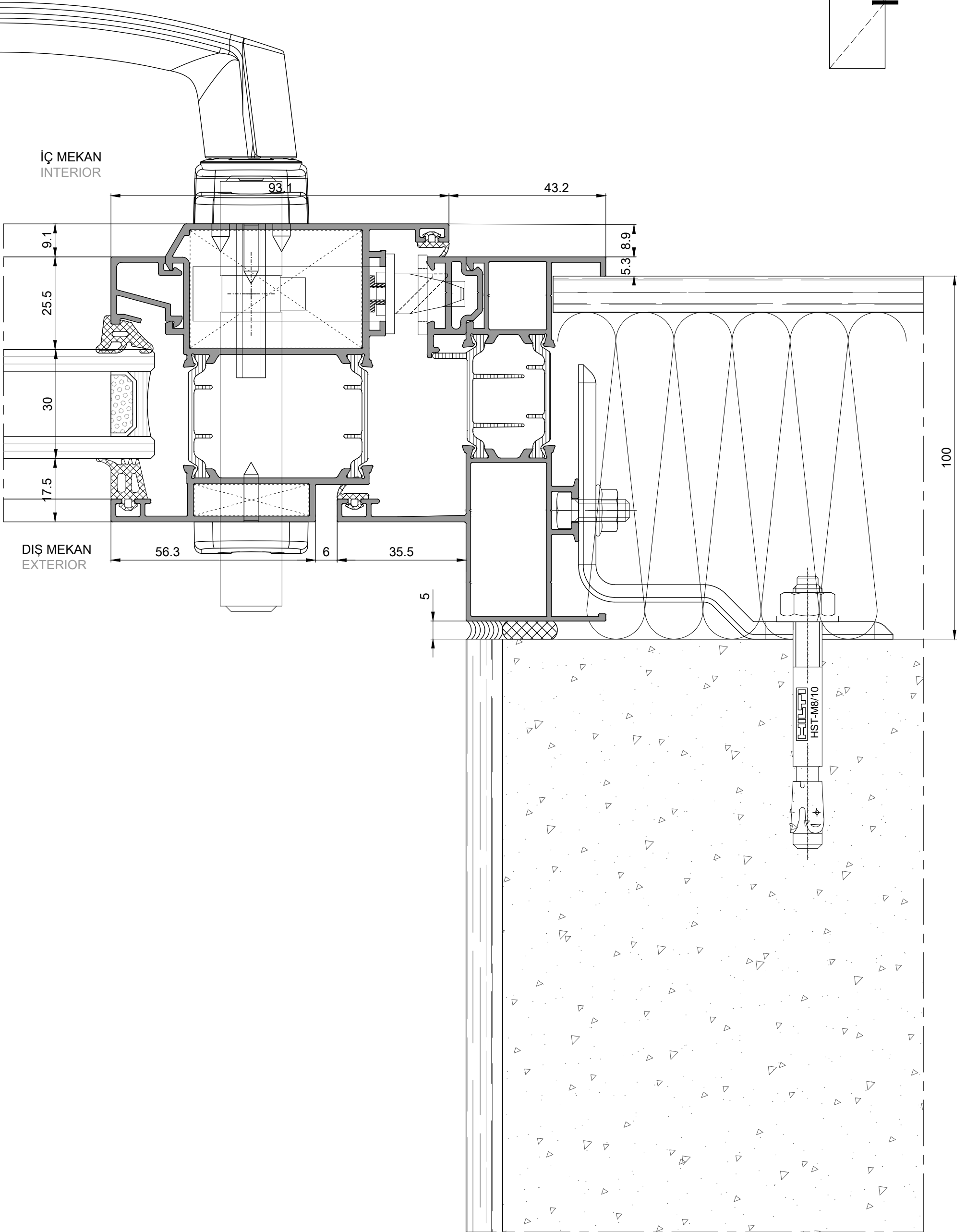
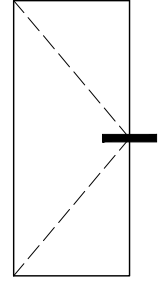

120mm YALITIMLI SAG YAN DETAY
120mm isolation with right side detail

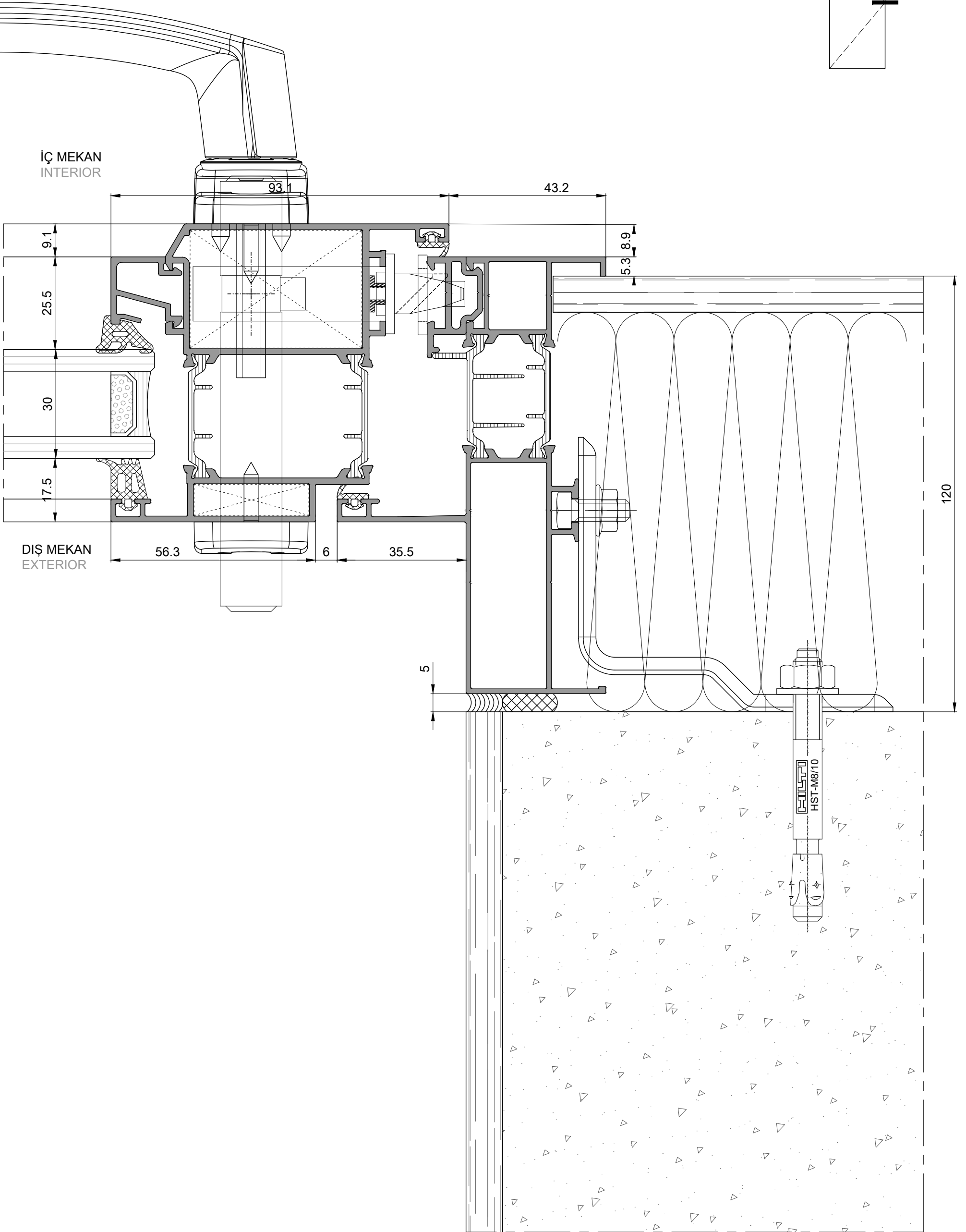
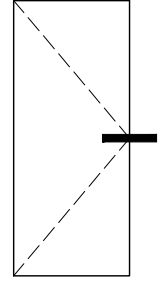

140mm YALITIMLI SAG YAN DETAY
140mm isolation with right side detail

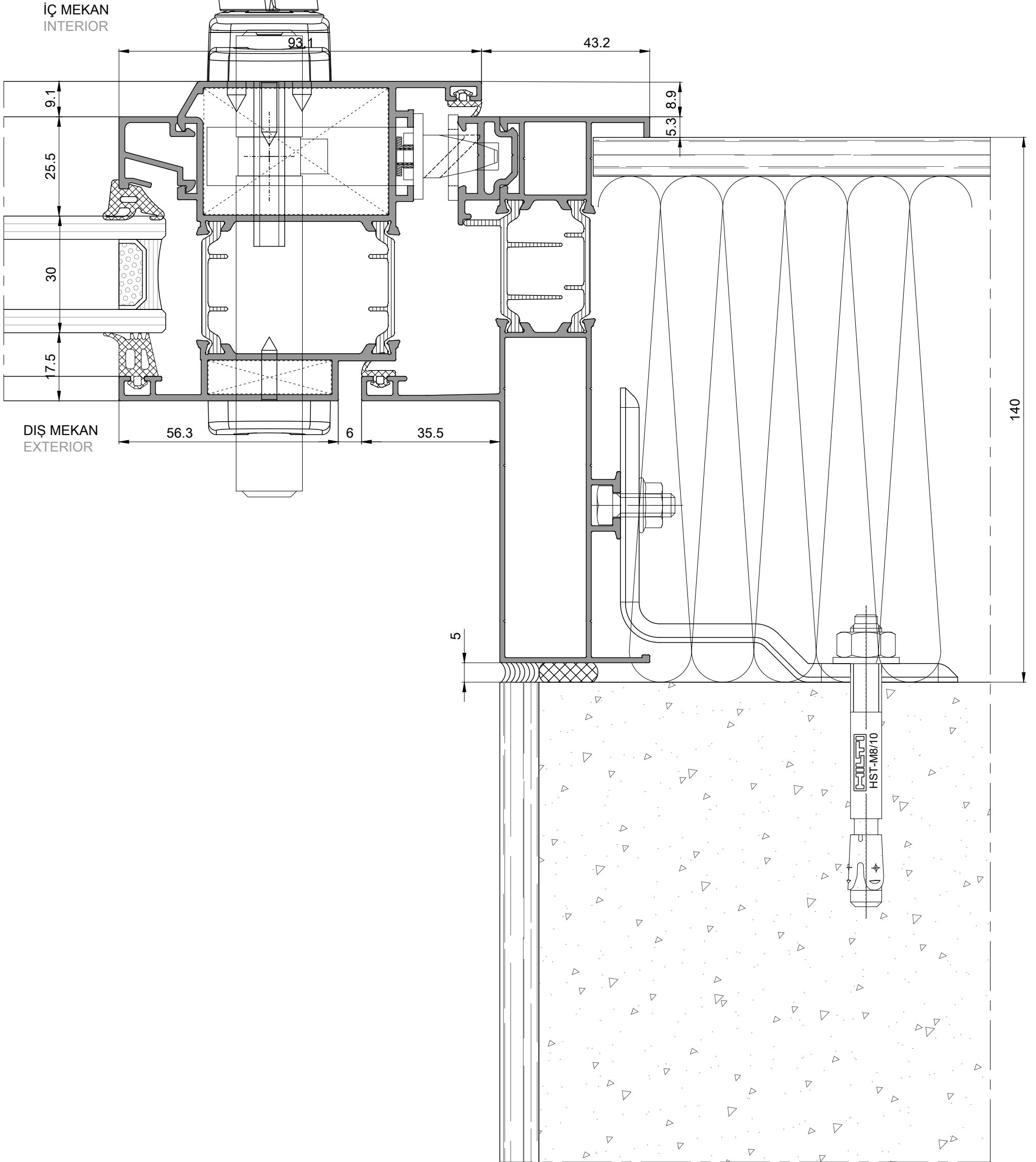
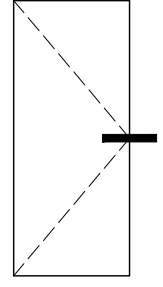

160mm YALITIMLI SAG YAN DETAY
160mm isolation with right side detail

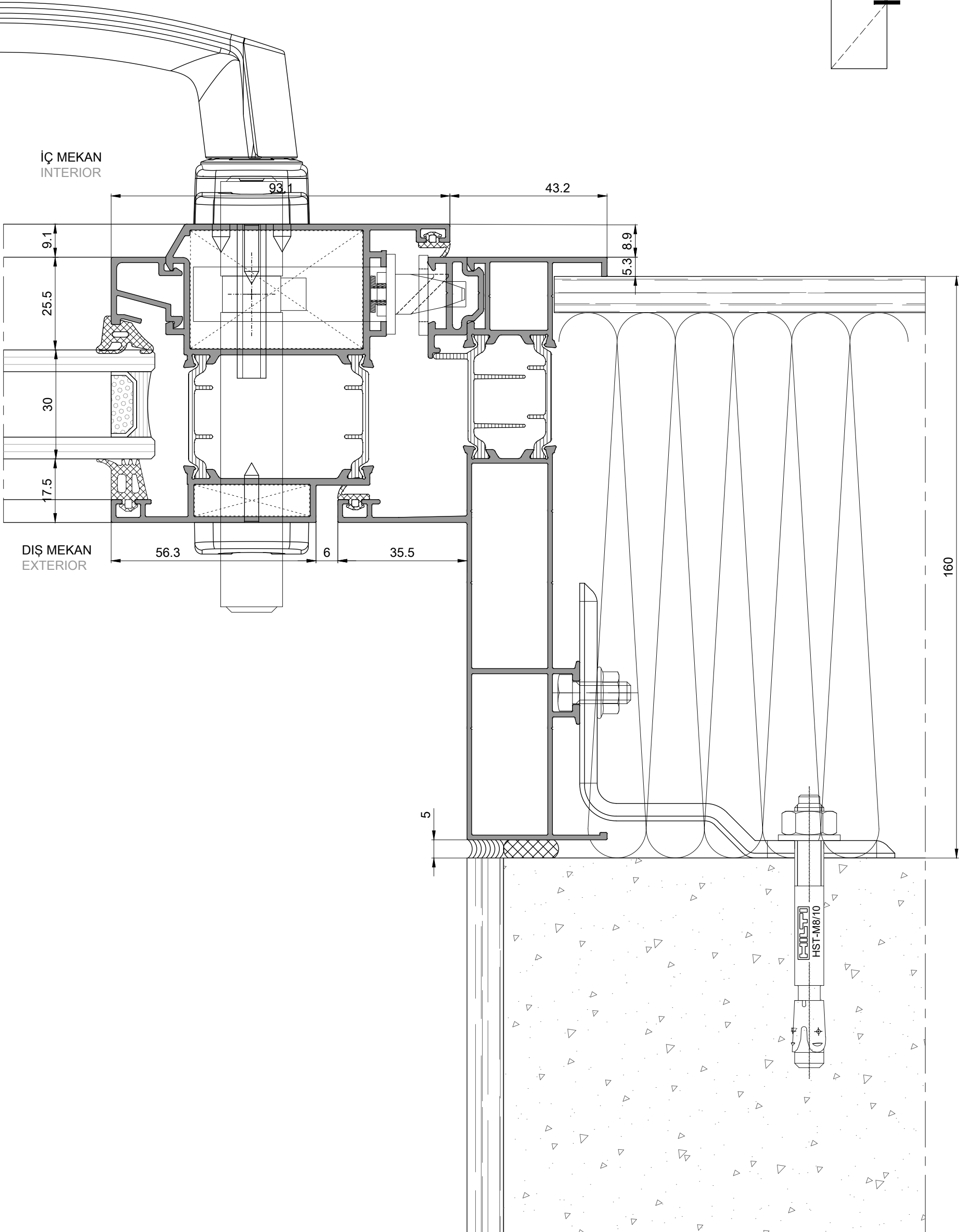
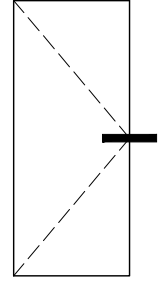

180mm YALITIMLI SAG YAN DETAY
180mm isolation with right side detail

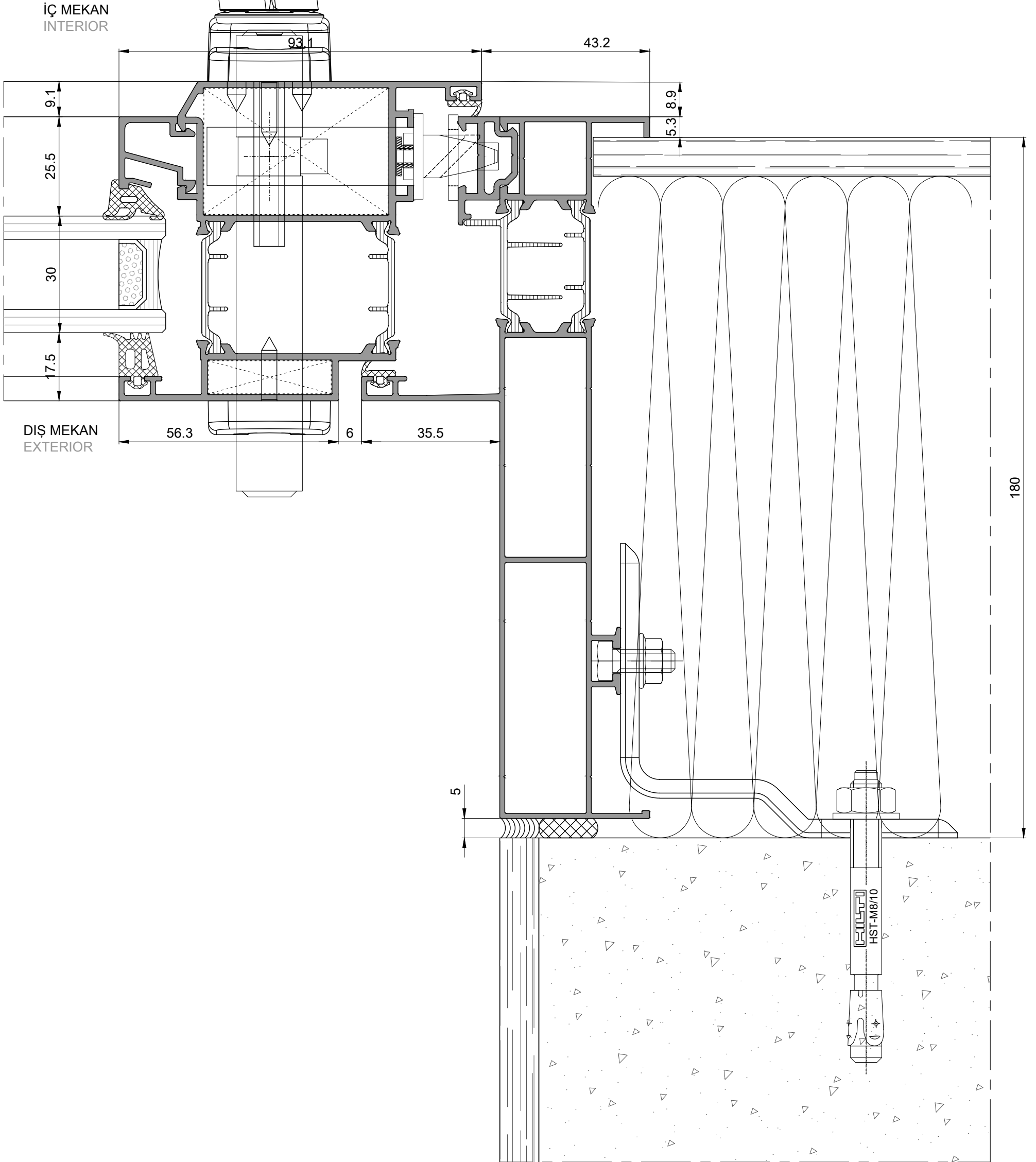
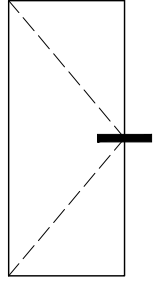

200mm YALITIMLI SAG YAN DETAY
200mm isolation with right side detail

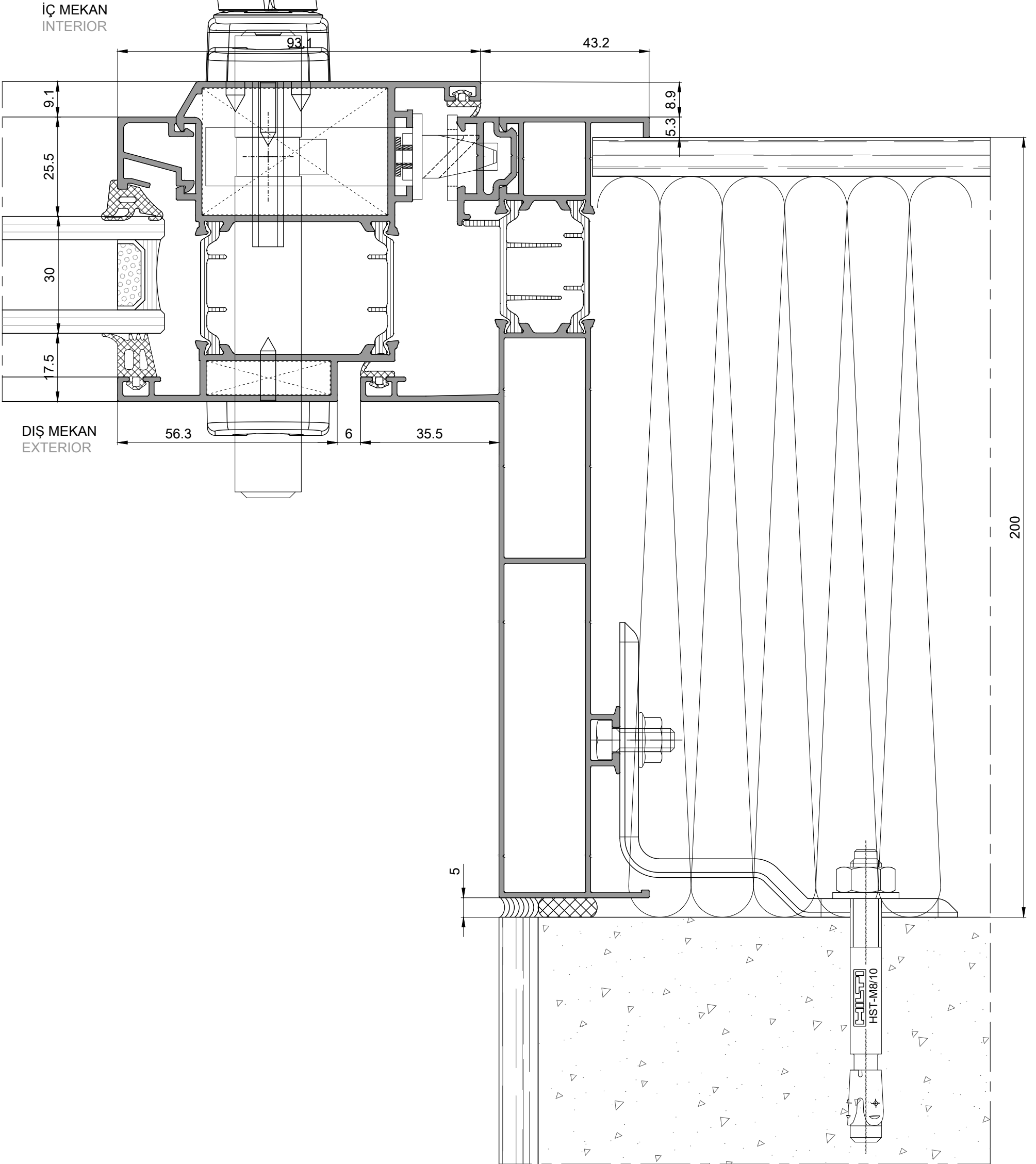
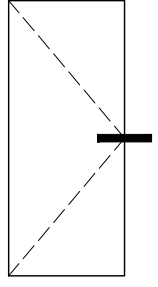

100mm YALITIMLI ÜST DETAY
100mm isolation with top side detail

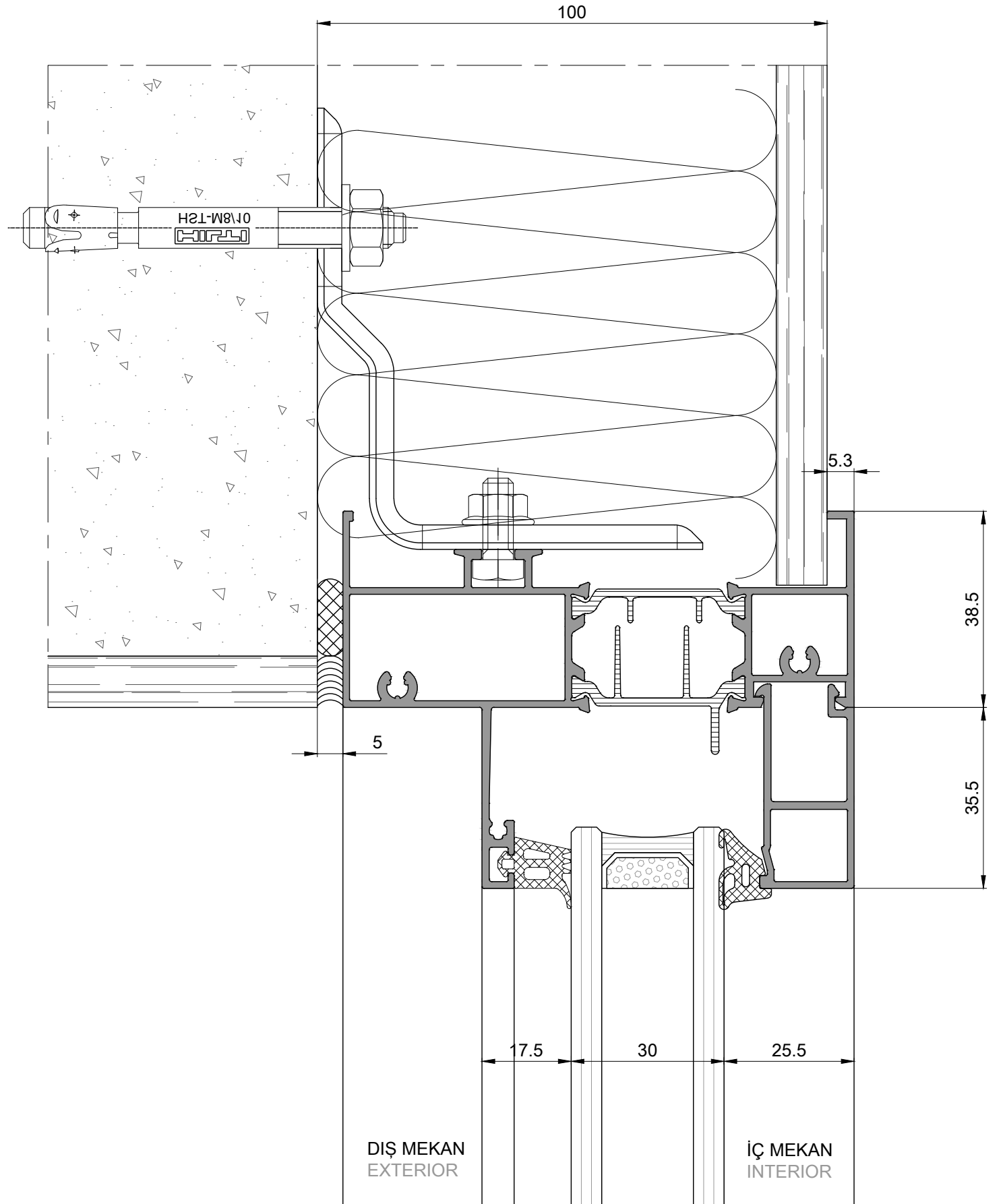
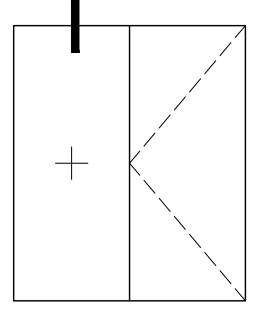

100mm YALITIMLI ÜST DETAY
100mm isolation with top side detail

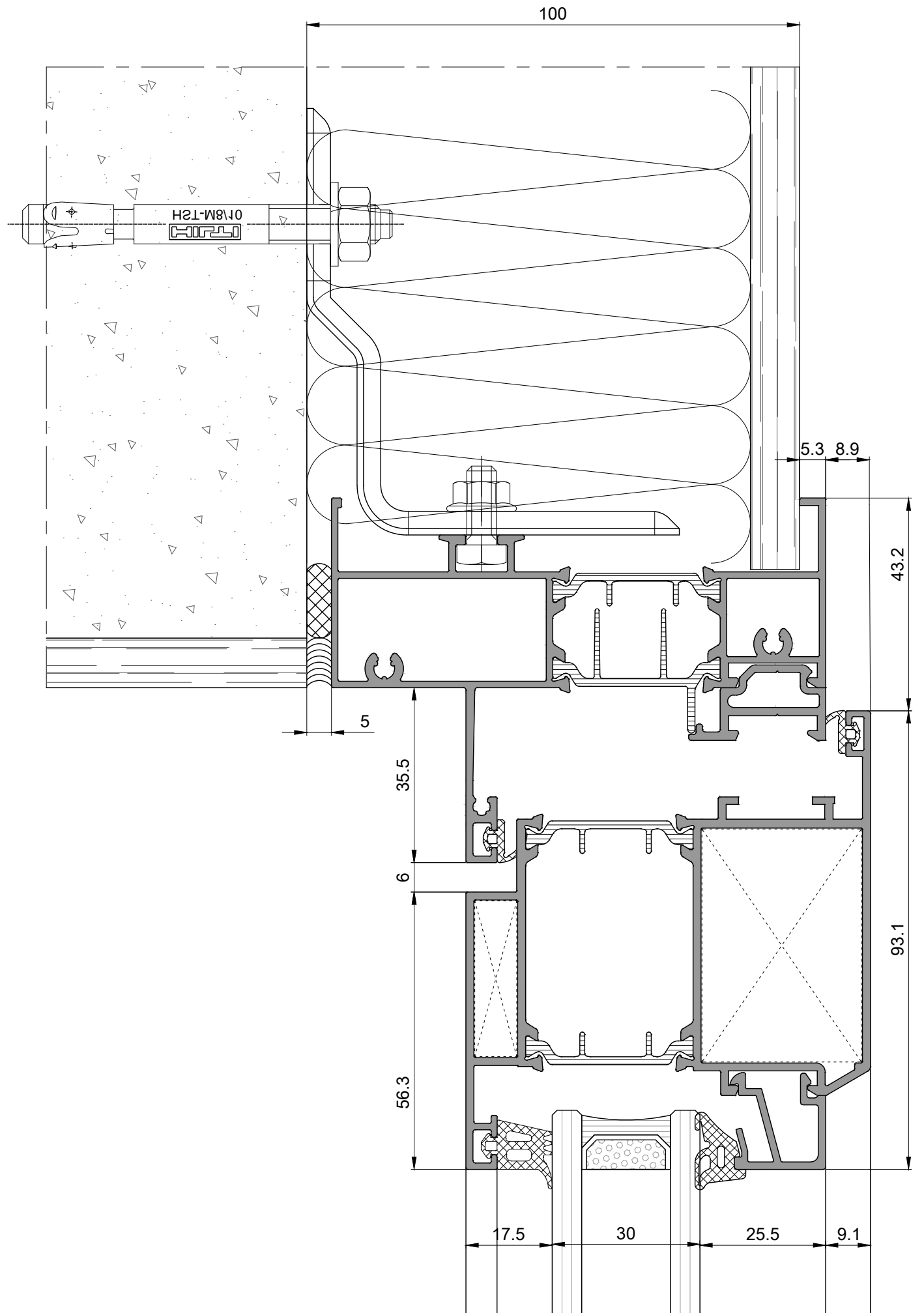
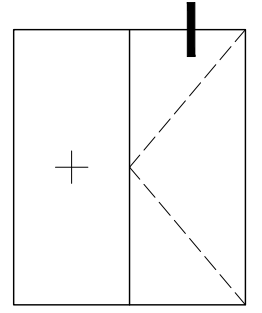

120mm YALITIMLI ÜST DETAY
120mm isolation with top side detail

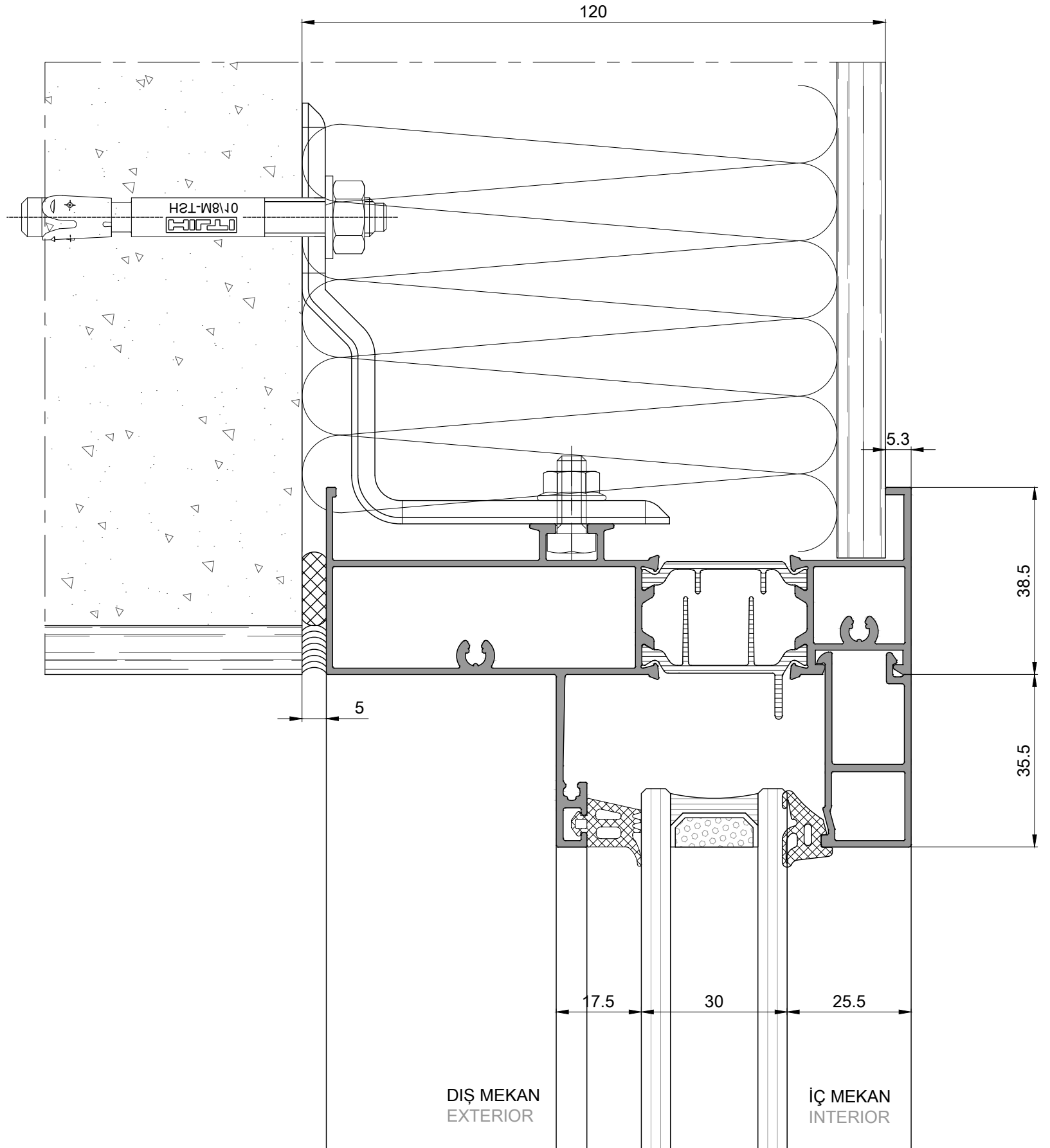
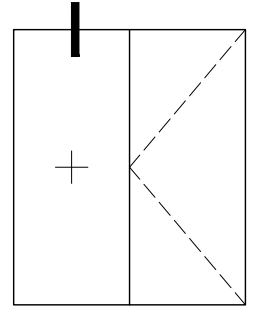

120mm YALITIMLI ÜST DETAY
120mm isolation with top side detail

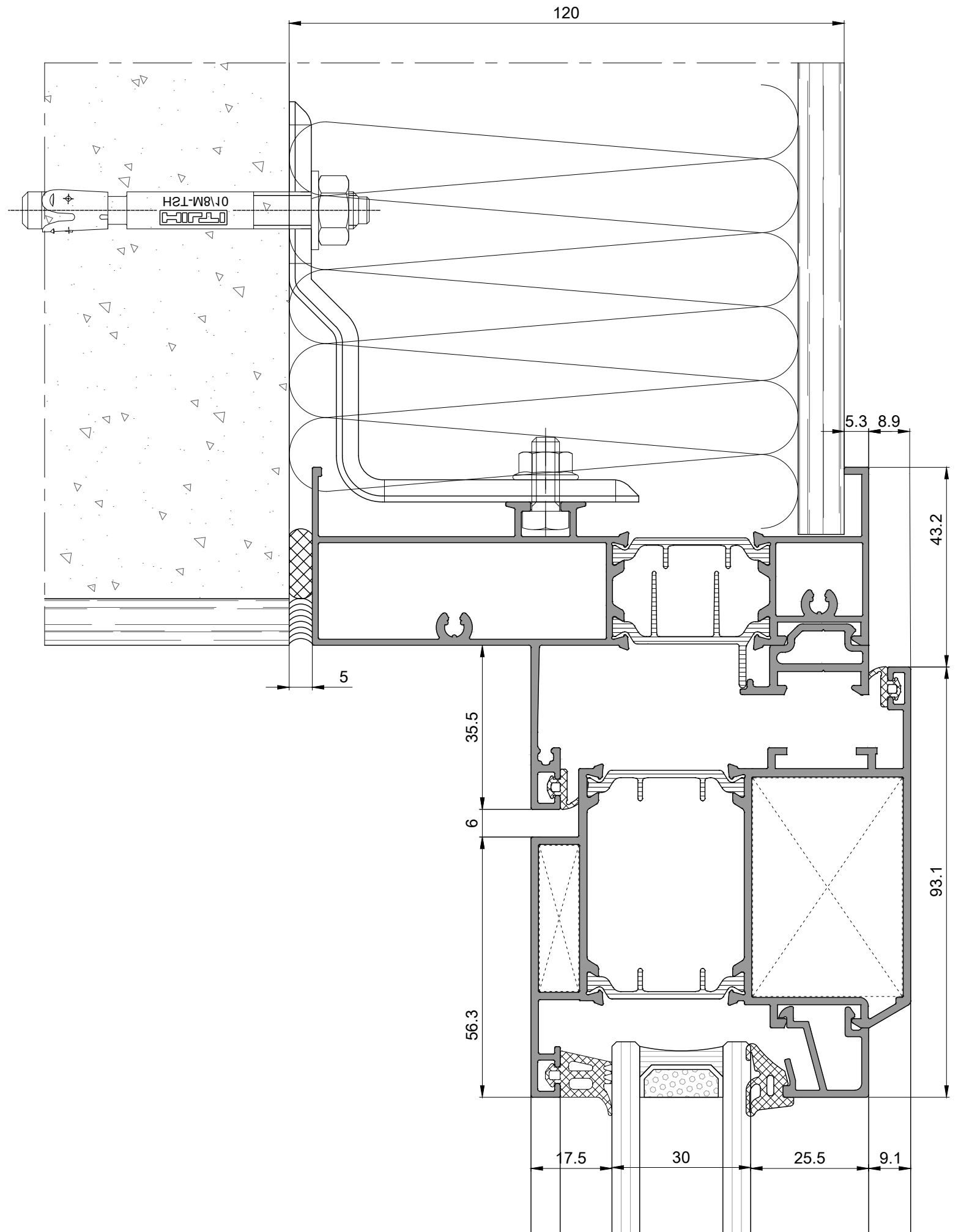
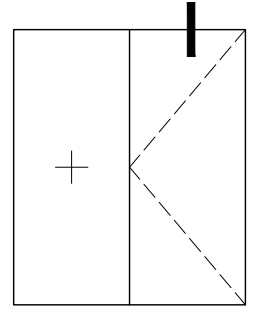

140mm YALITIMLI ÜST DETAY
140mm isolation with top side detail

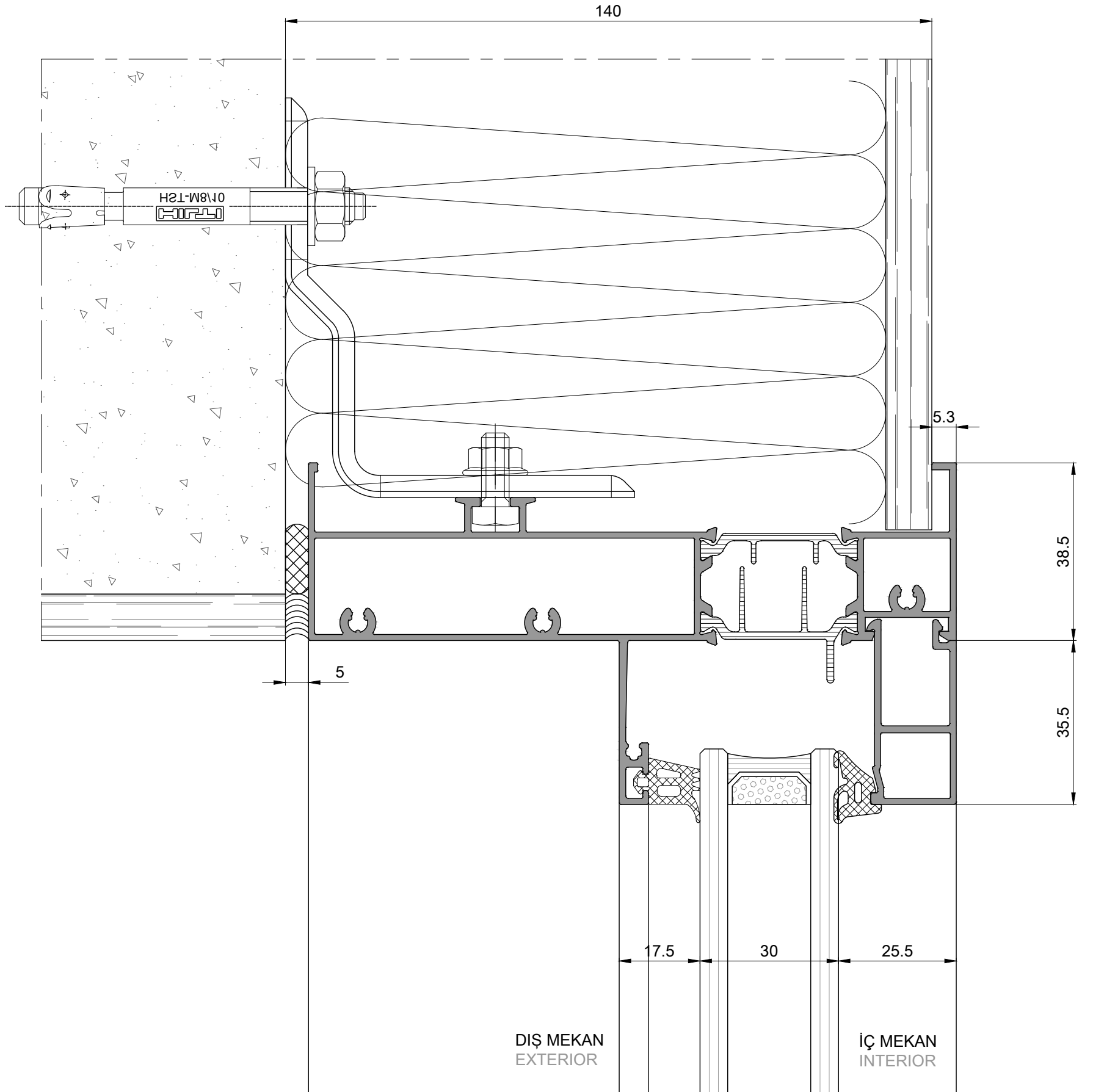
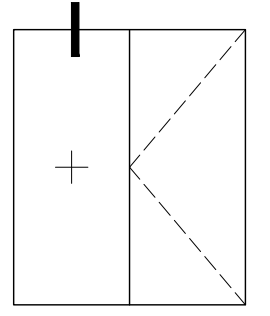

140mm YALITIMLI ÜST DETAY
140mm isolation with top side detail

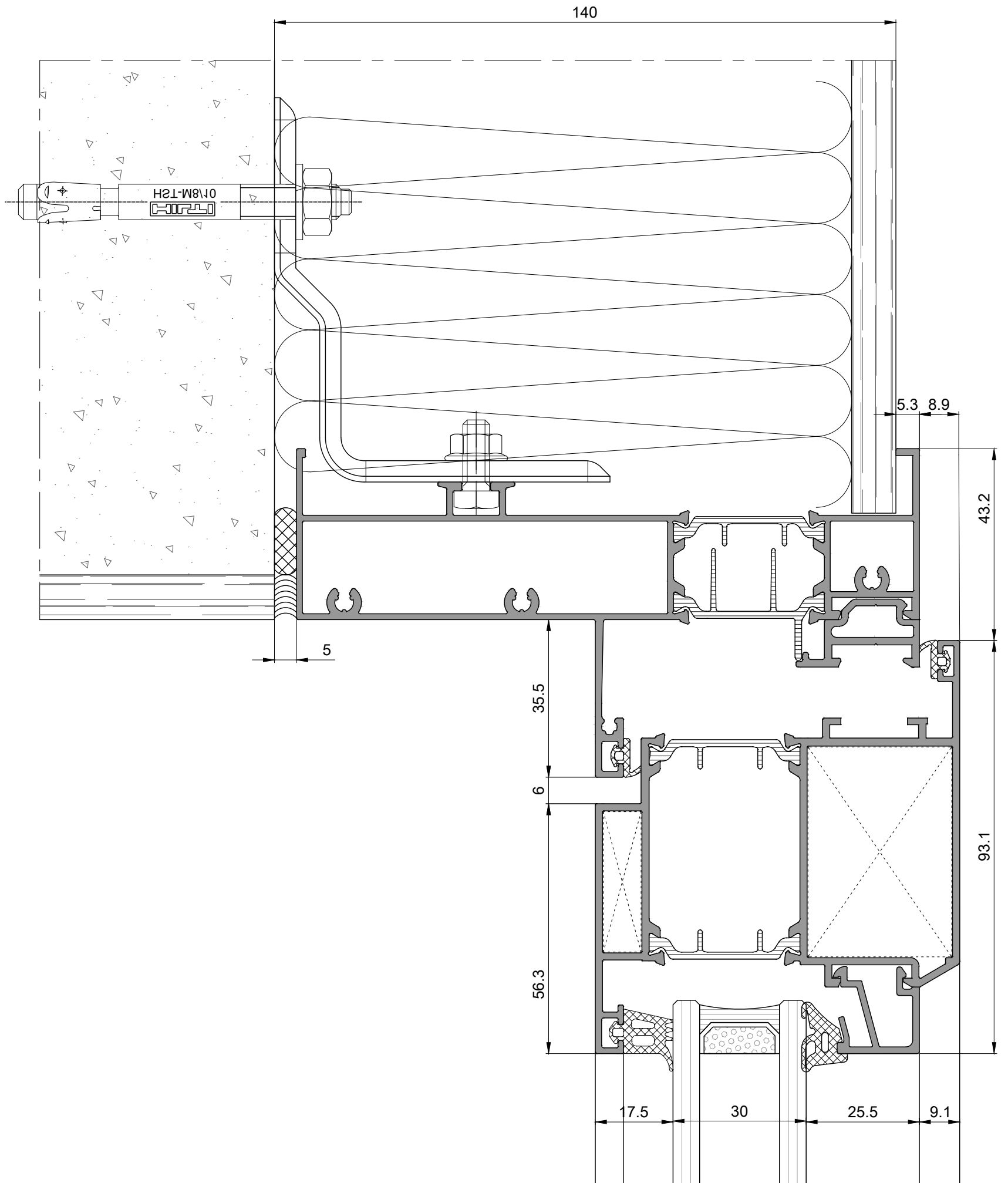
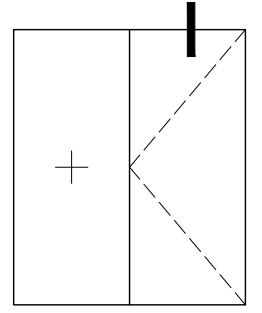

160mm YALITIMLI ÜST DETAY
160mm isolation with top side detail

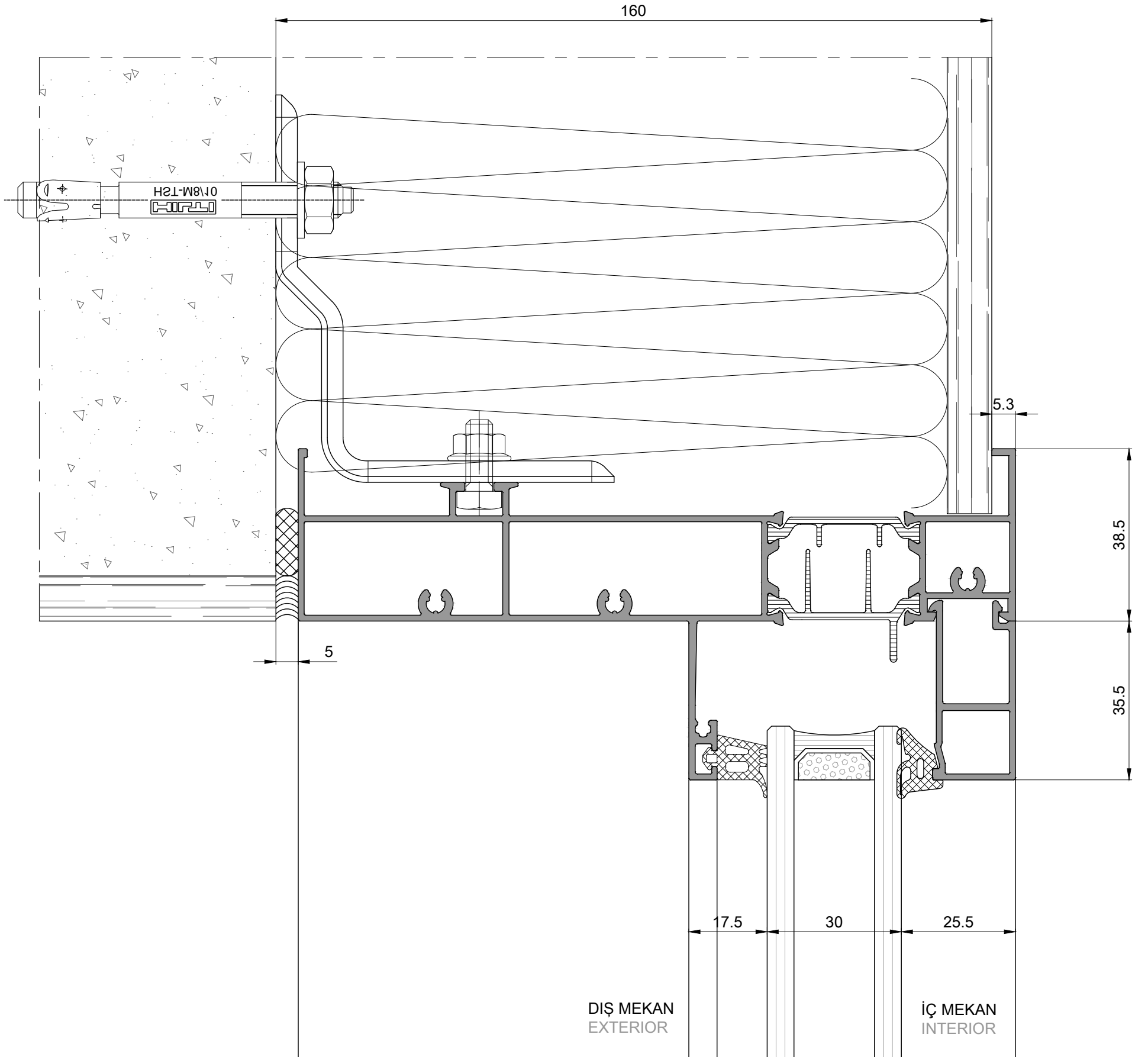
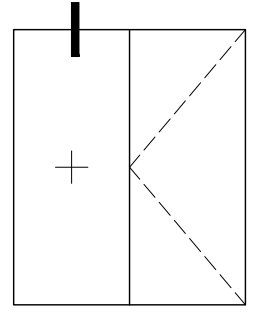

160mm YALITIMLI ÜST DETAY
160mm isolation with top side detail

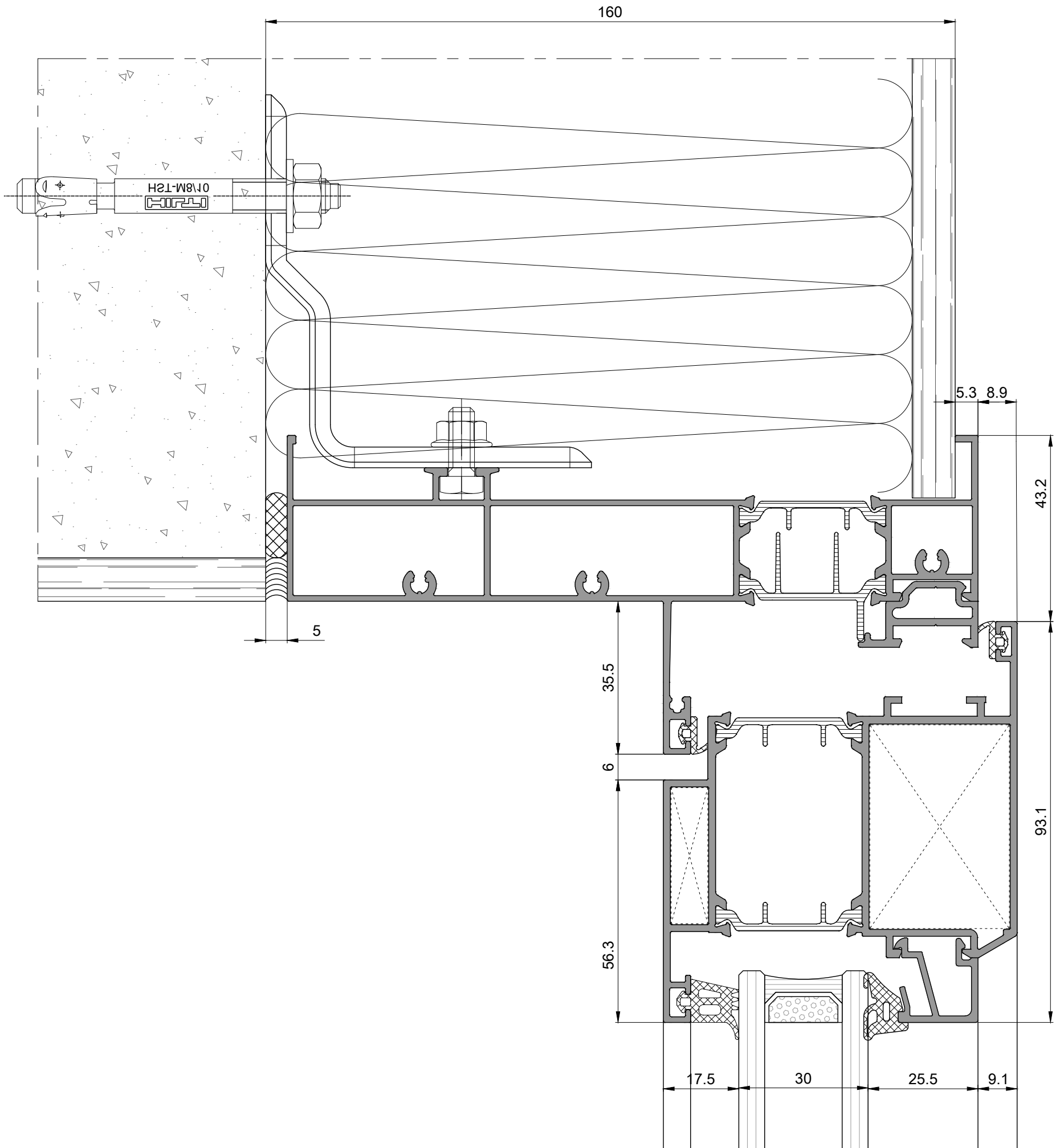
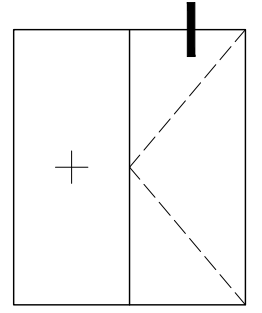

180mm YALITIMLI ÜST DETAY
180mm isolation with top side detail

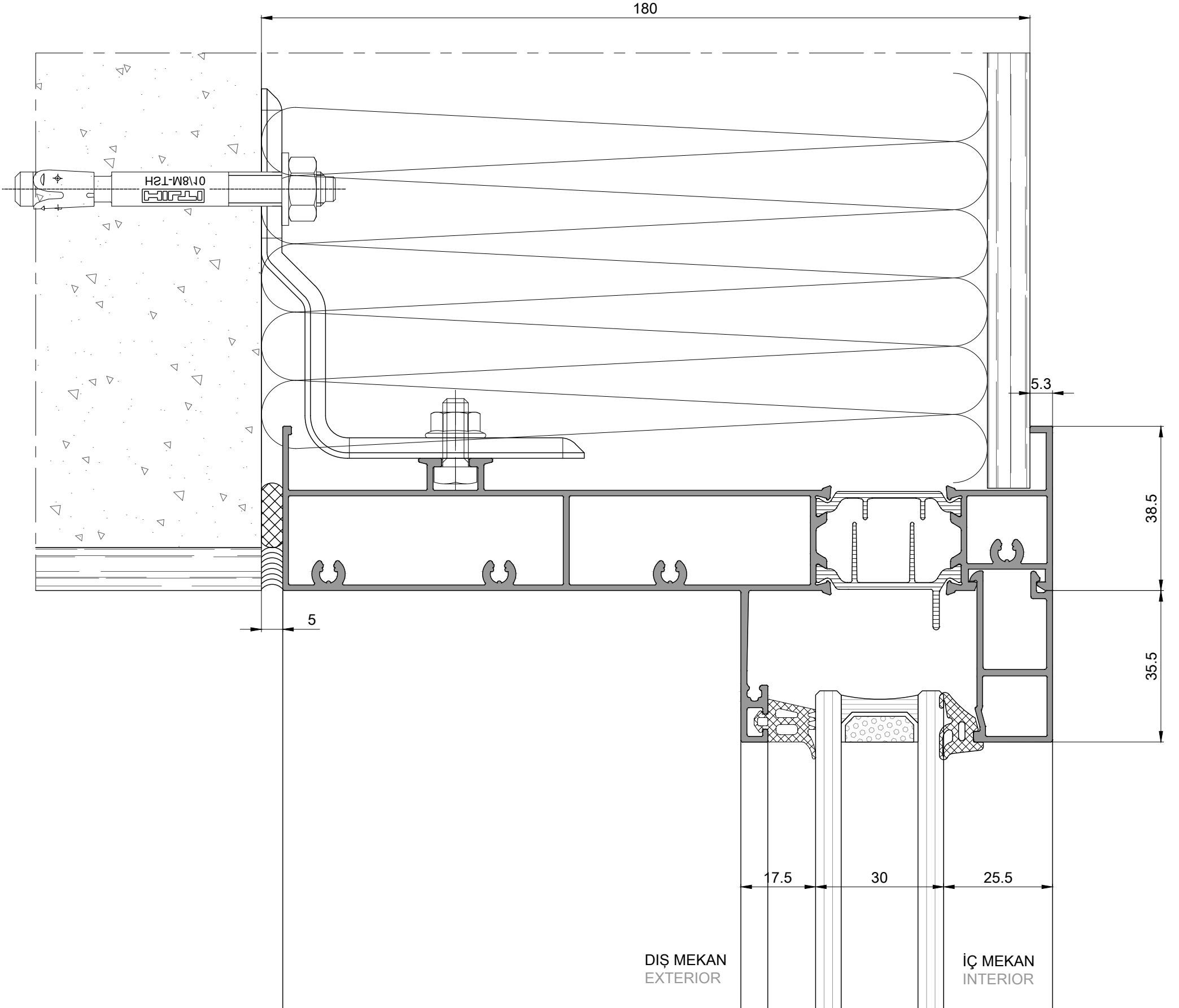
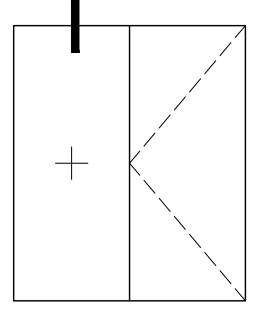

180mm YALITIMLI ÜST DETAY
180mm isolation with top side detail

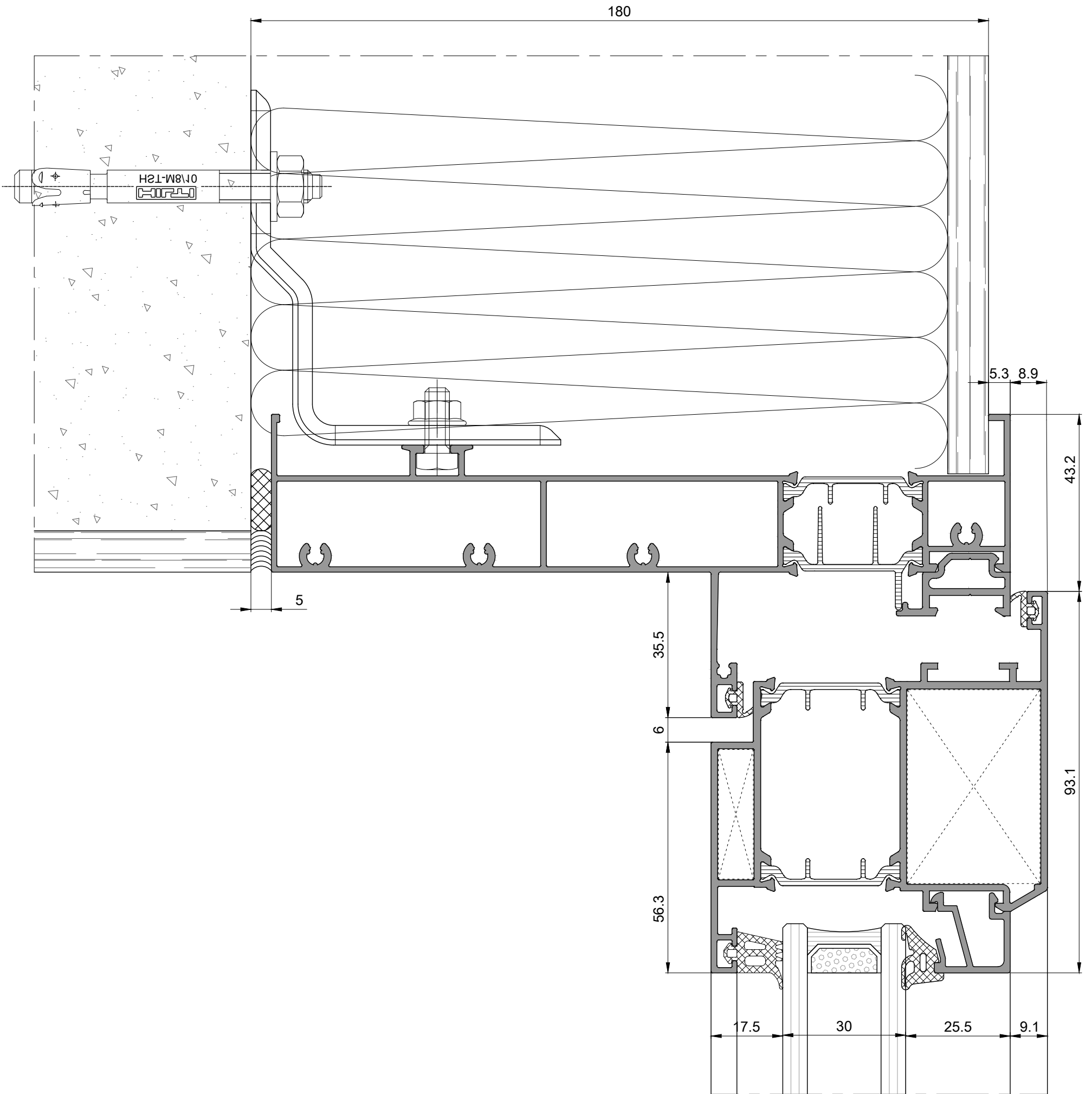
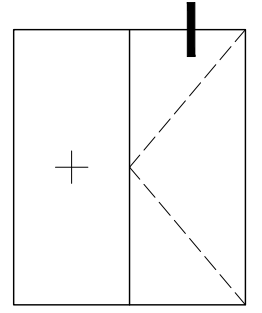

200mm YALITIMLI ÜST DETAY
200mm isolation with top side detail

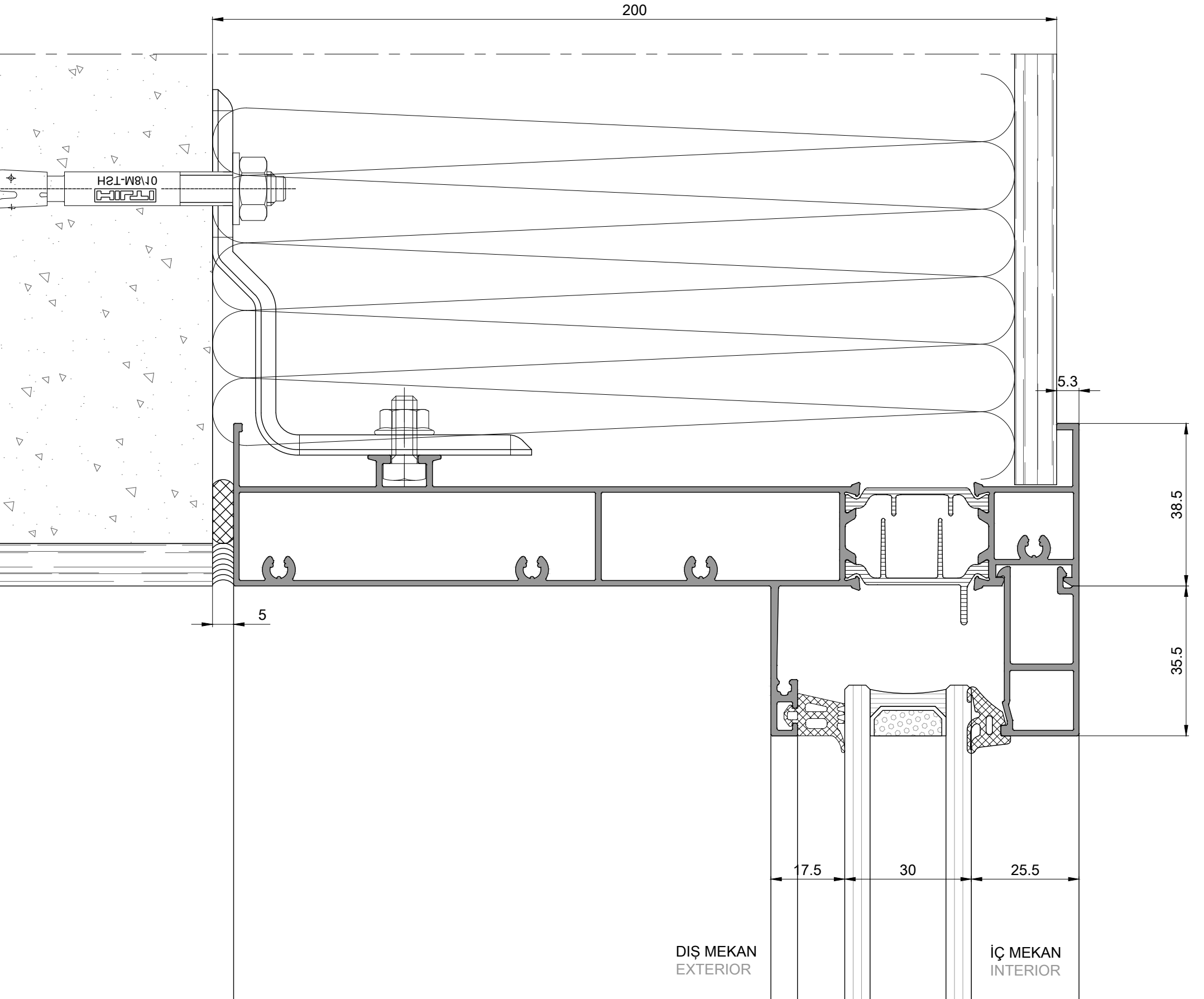
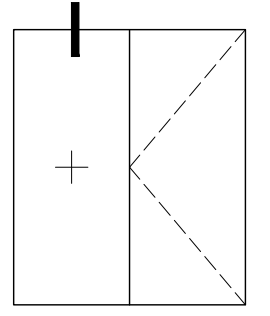

200mm YALITIMLI ÜST DETAY
200mm isolation with top side detail

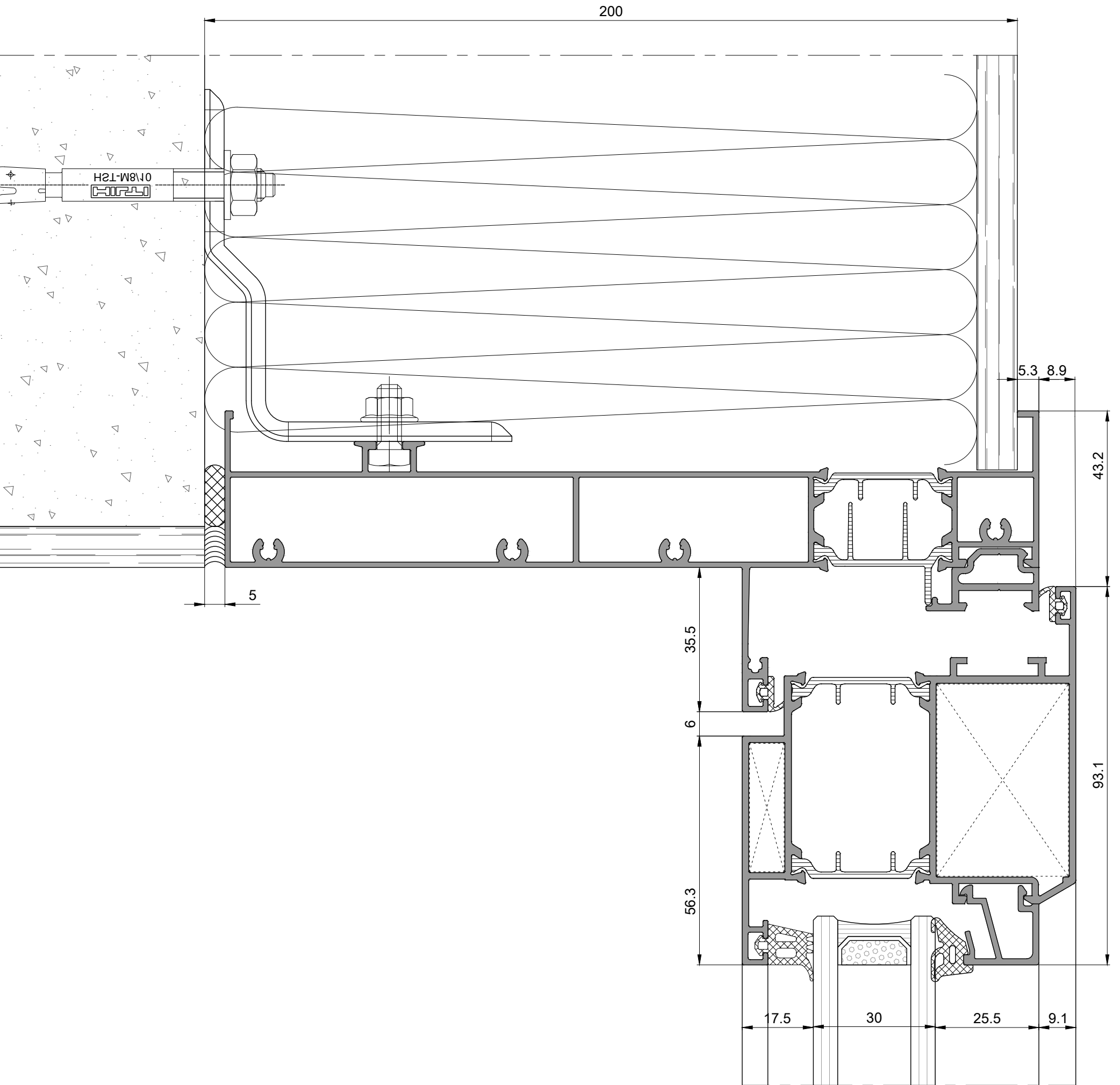
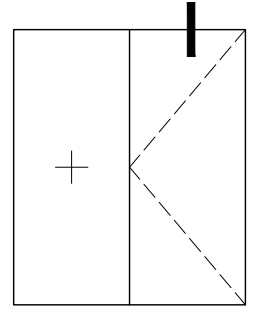

SABİT ALT DETAY
fixed glass bottom detail

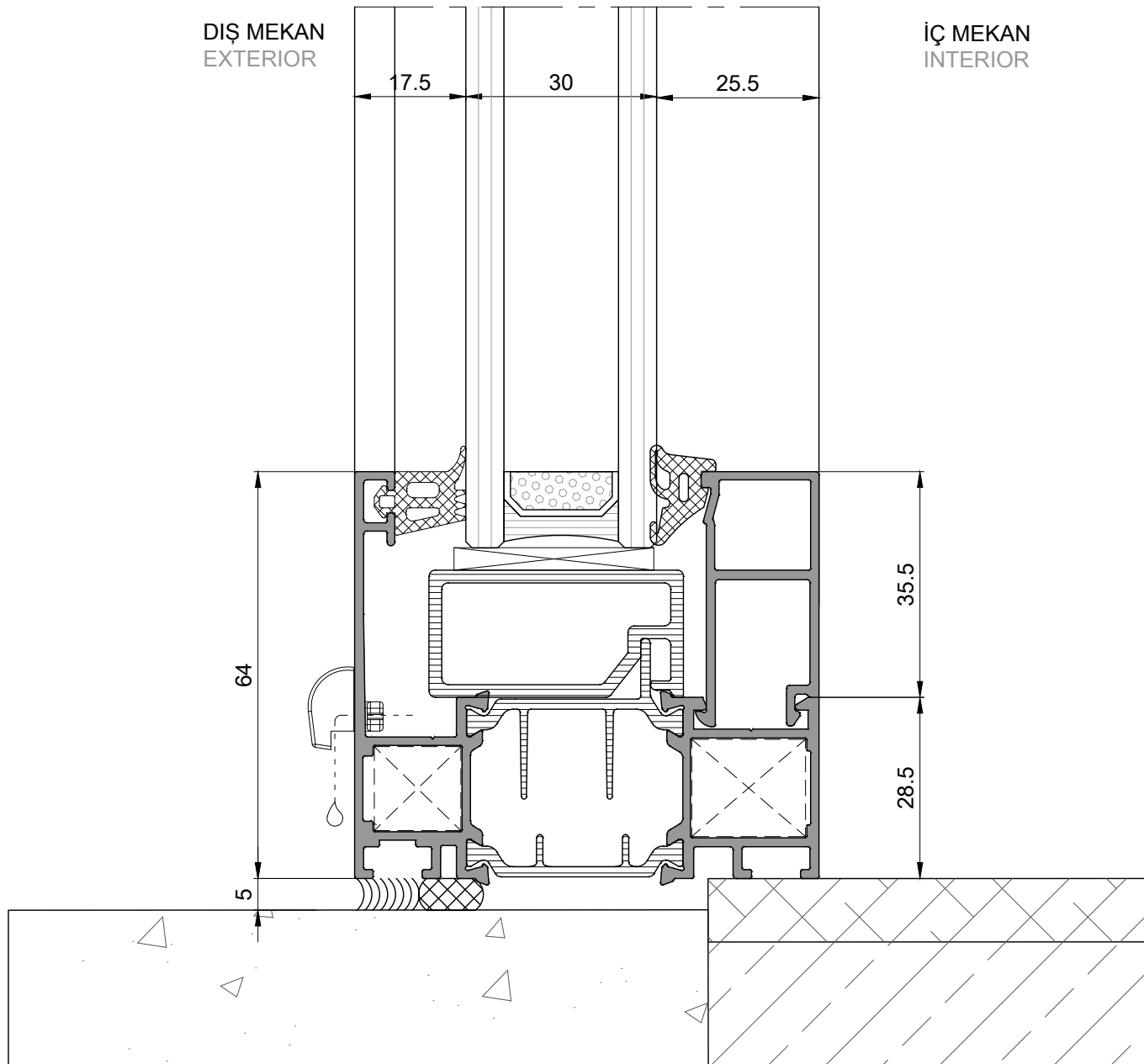
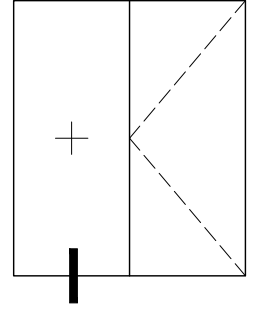

KAPI ALT EŞİK DETAY
Door bottom side threshold detail

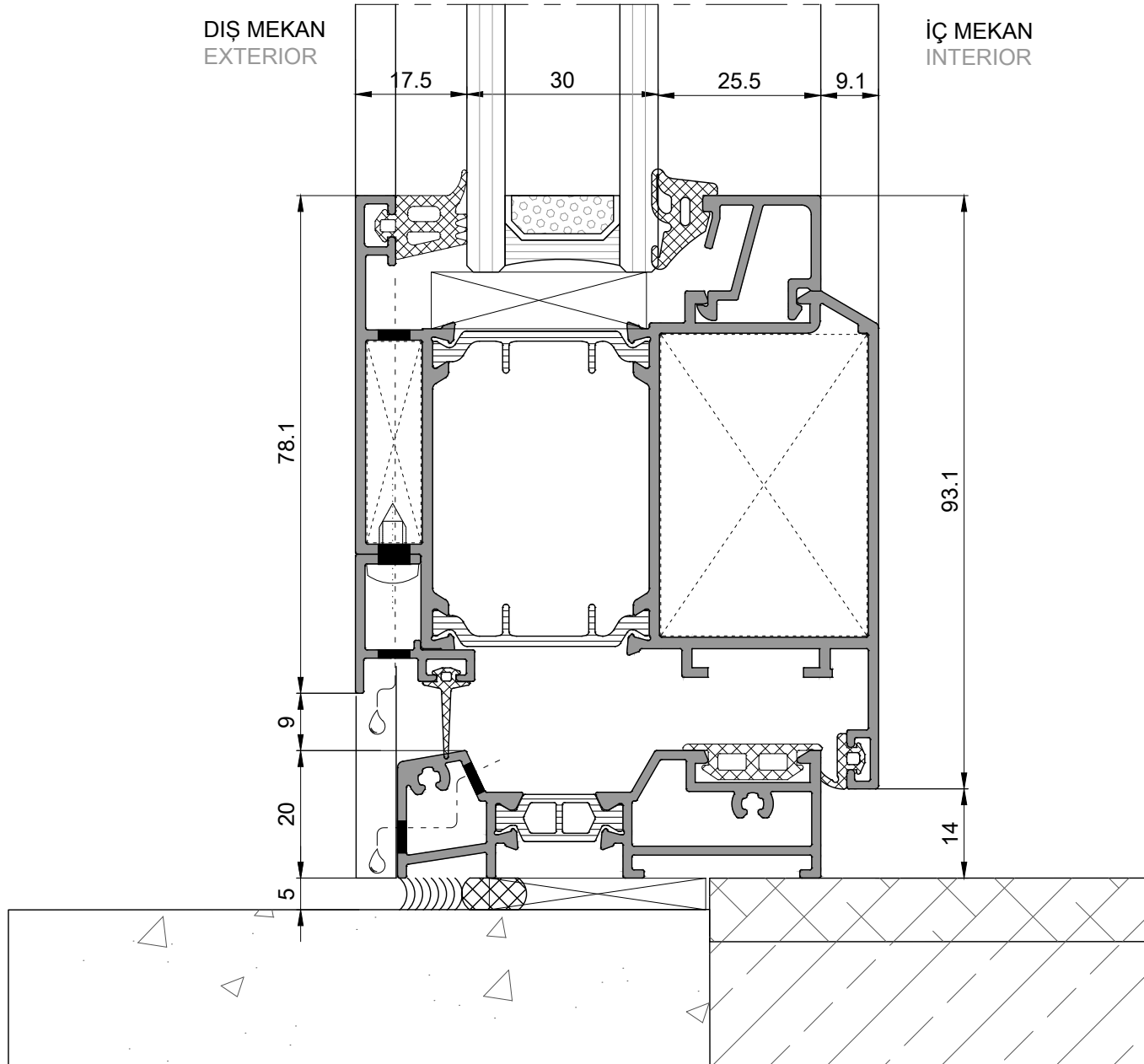
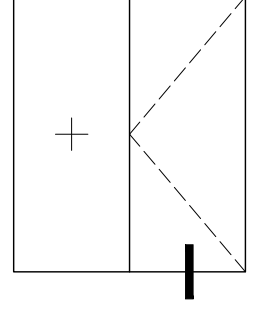

ALFA

GİZLİ KANATLI PENCERE ve KAPI SİSTEMİ CONCEALED SASH WINDOW and DOOR SYSTEM

YARDIMCI PROFİLLER İLE GİZLİ KANATLI
PENCERE PRENSİP SİSTEM DETAYLARI
PRINCIPAL SECTIONS for CONCEALED SASH
WINDOW with ADDITIONAL PROFILES

100mm YALITIMLI SOL YAN DETAY
100mm isolation with left side detail

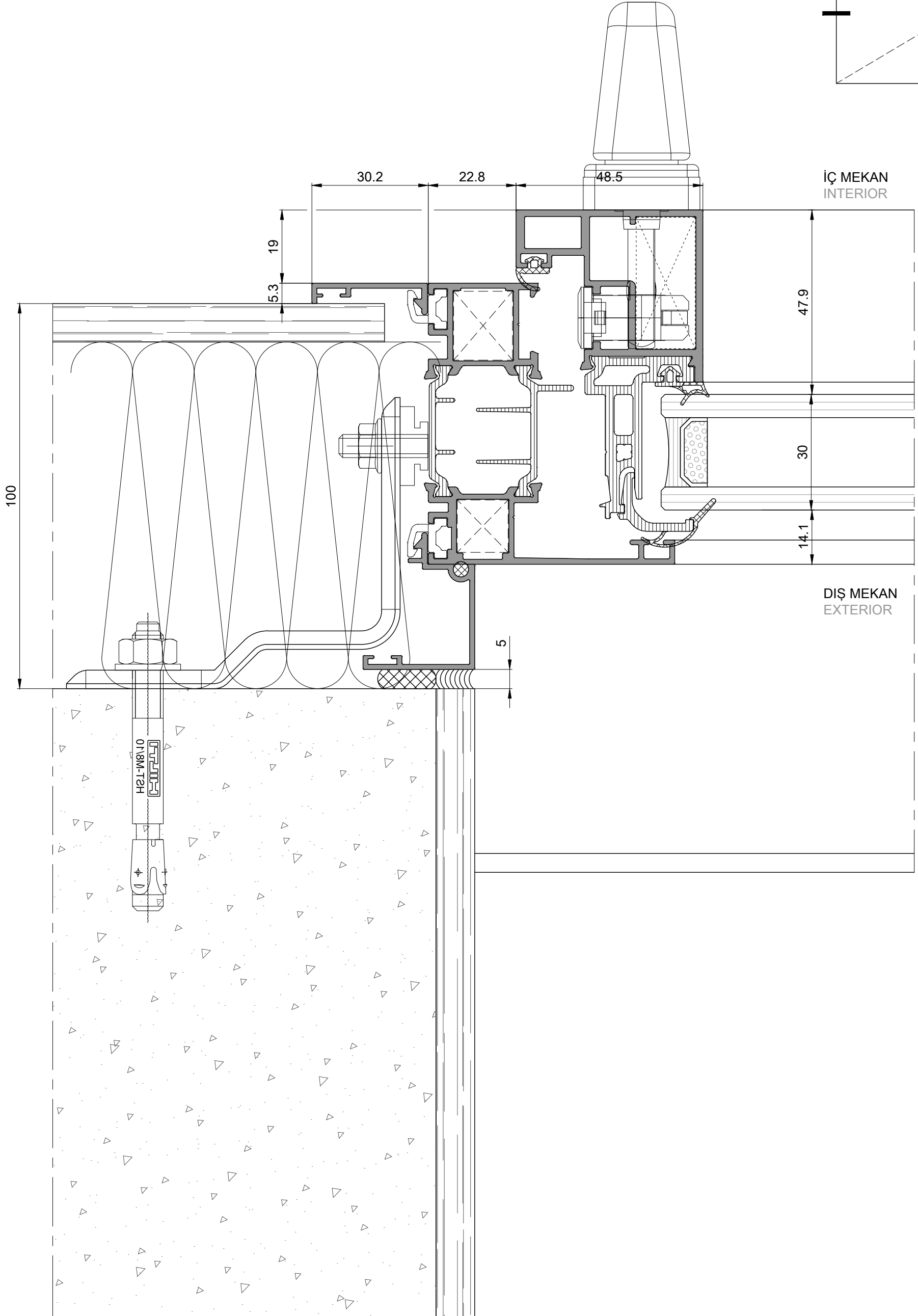

100mm YALITIMLI SOL YAN DETAY
100mm isolation with left side detail

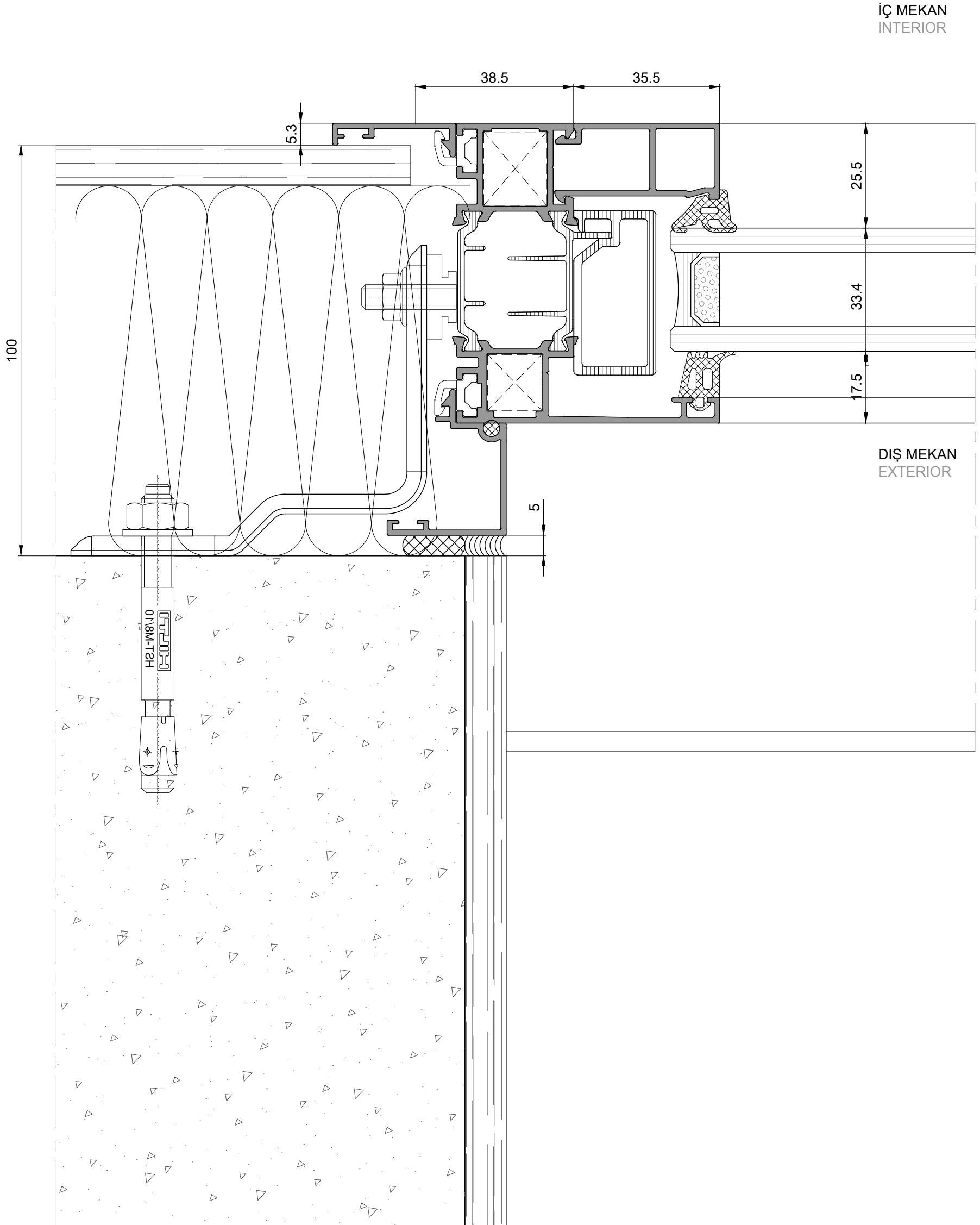
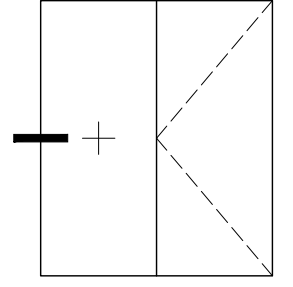

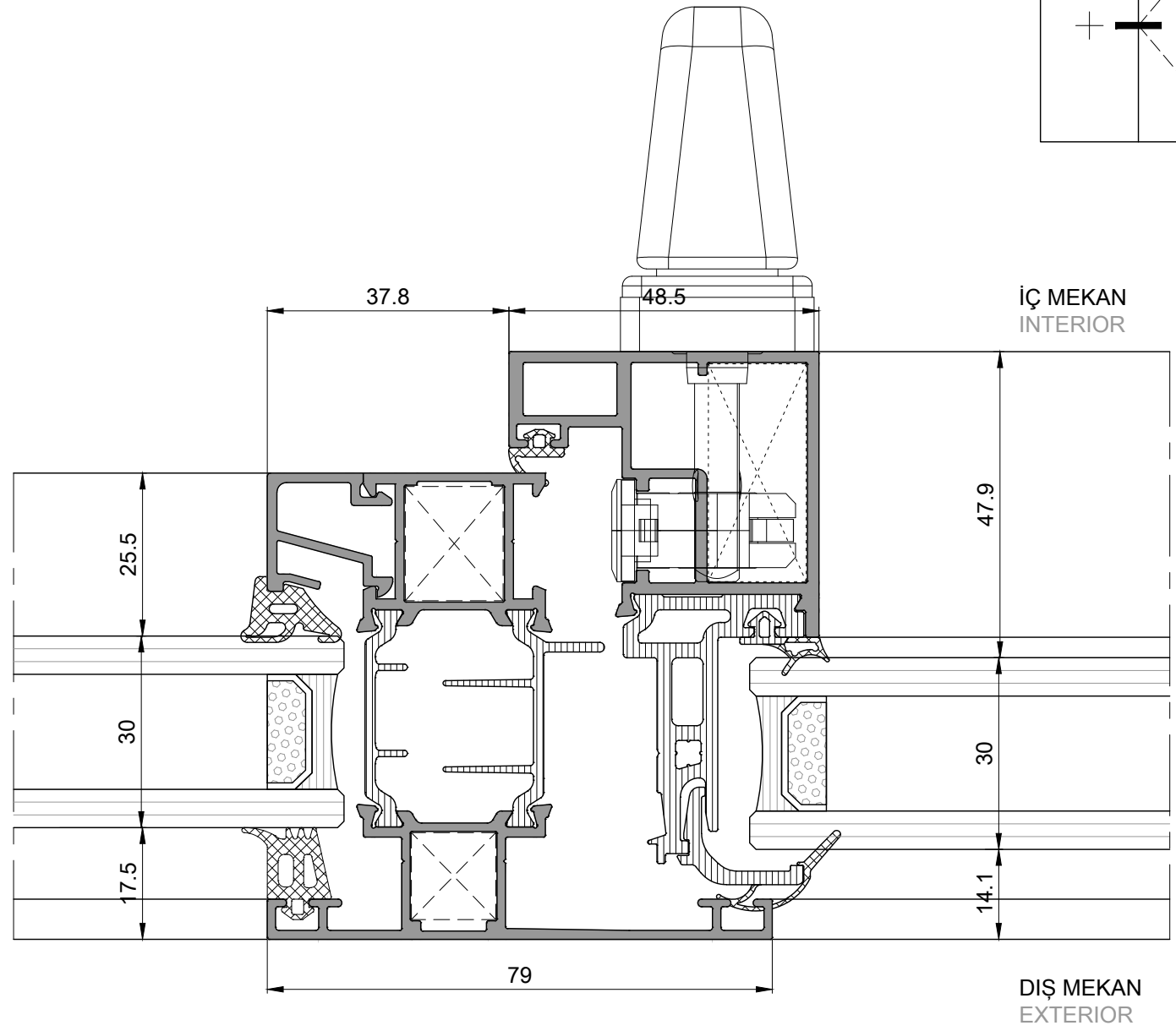
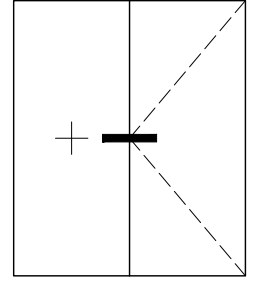

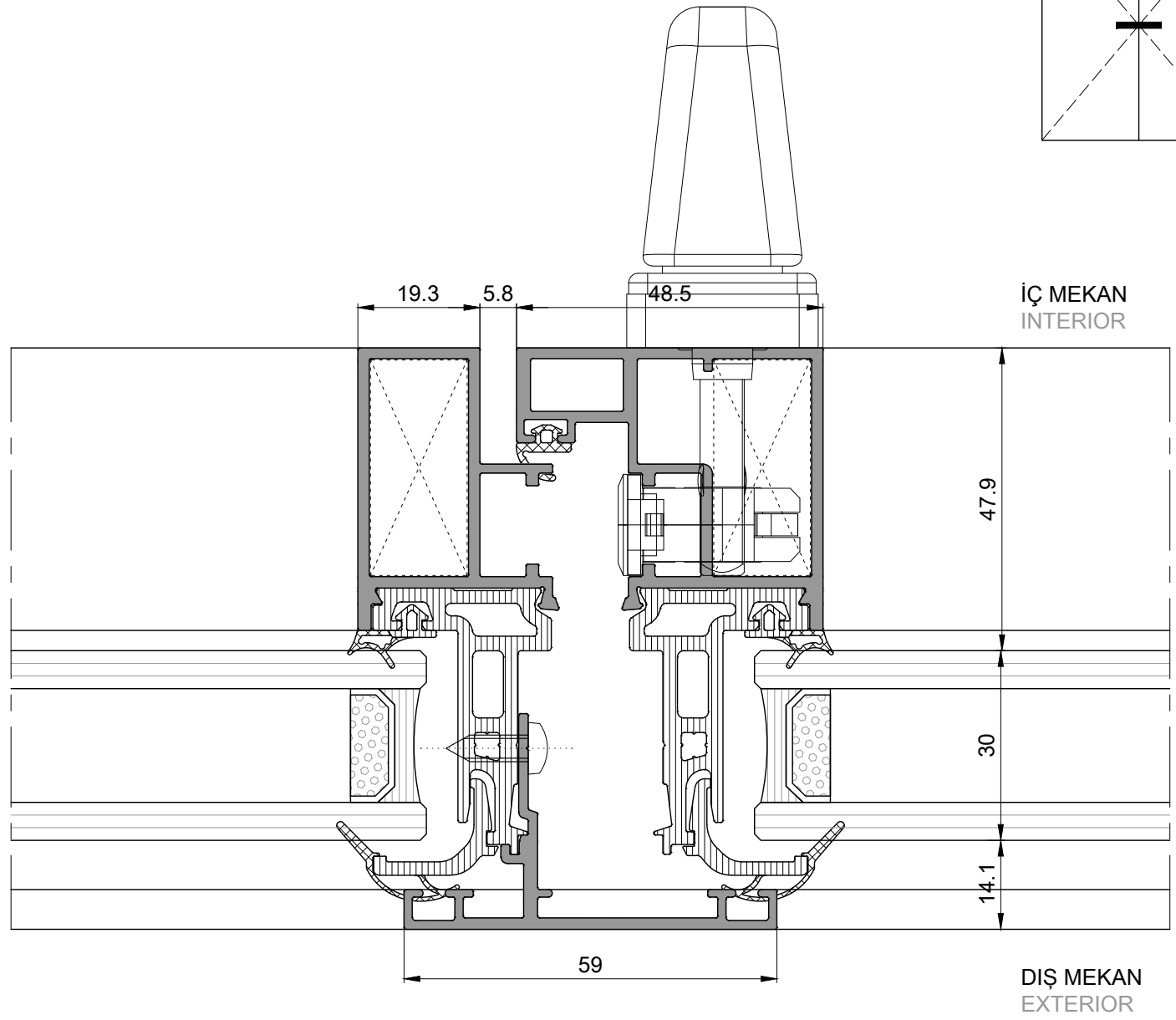
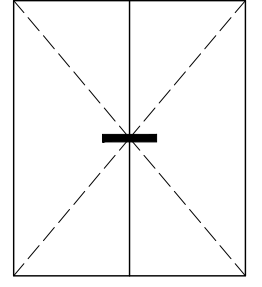

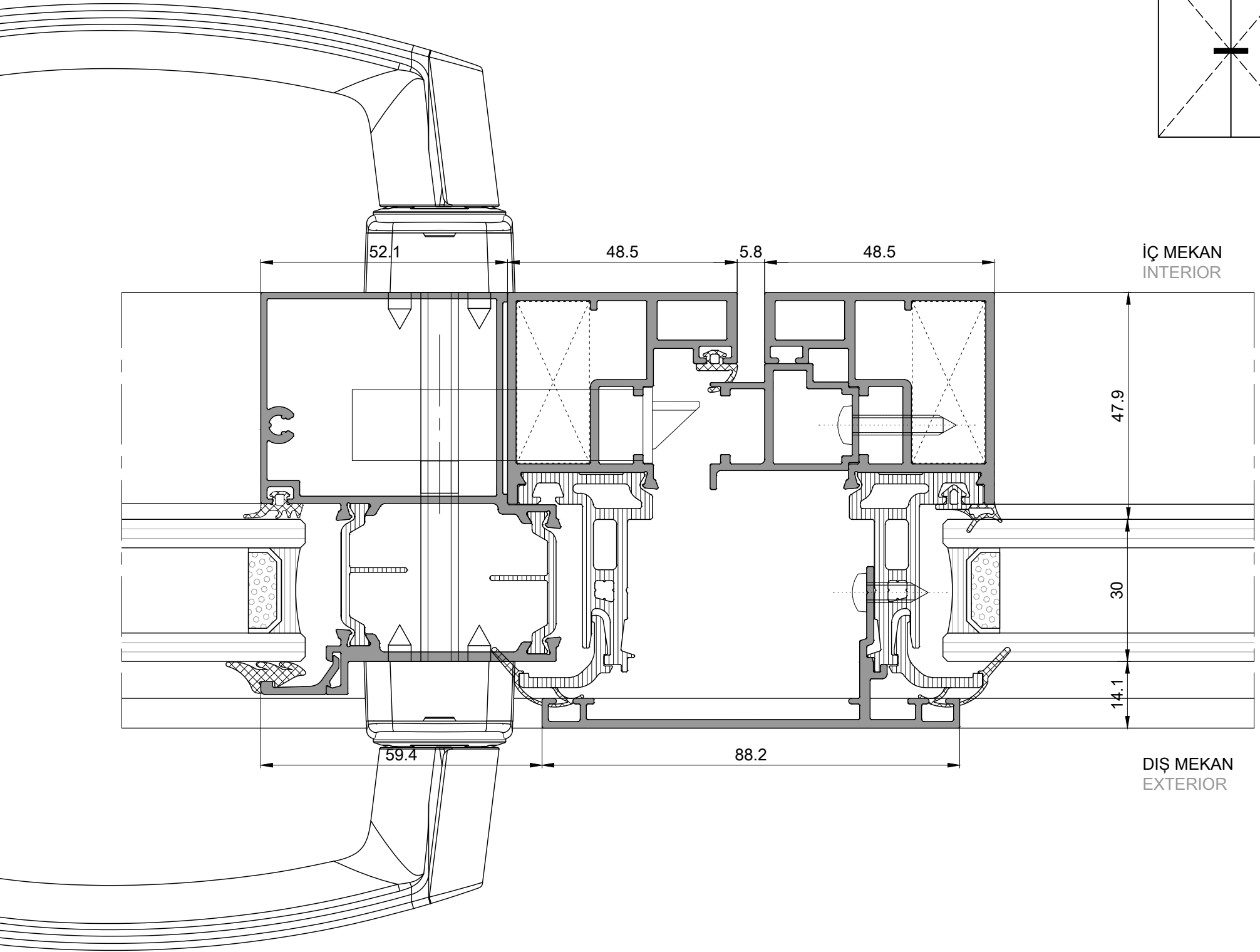
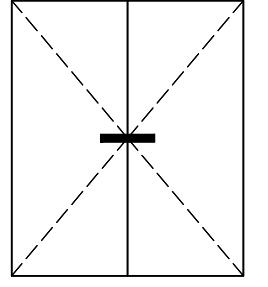

100mm YALITIMLI SOL YAN DETAY
100mm isolation with left side detail

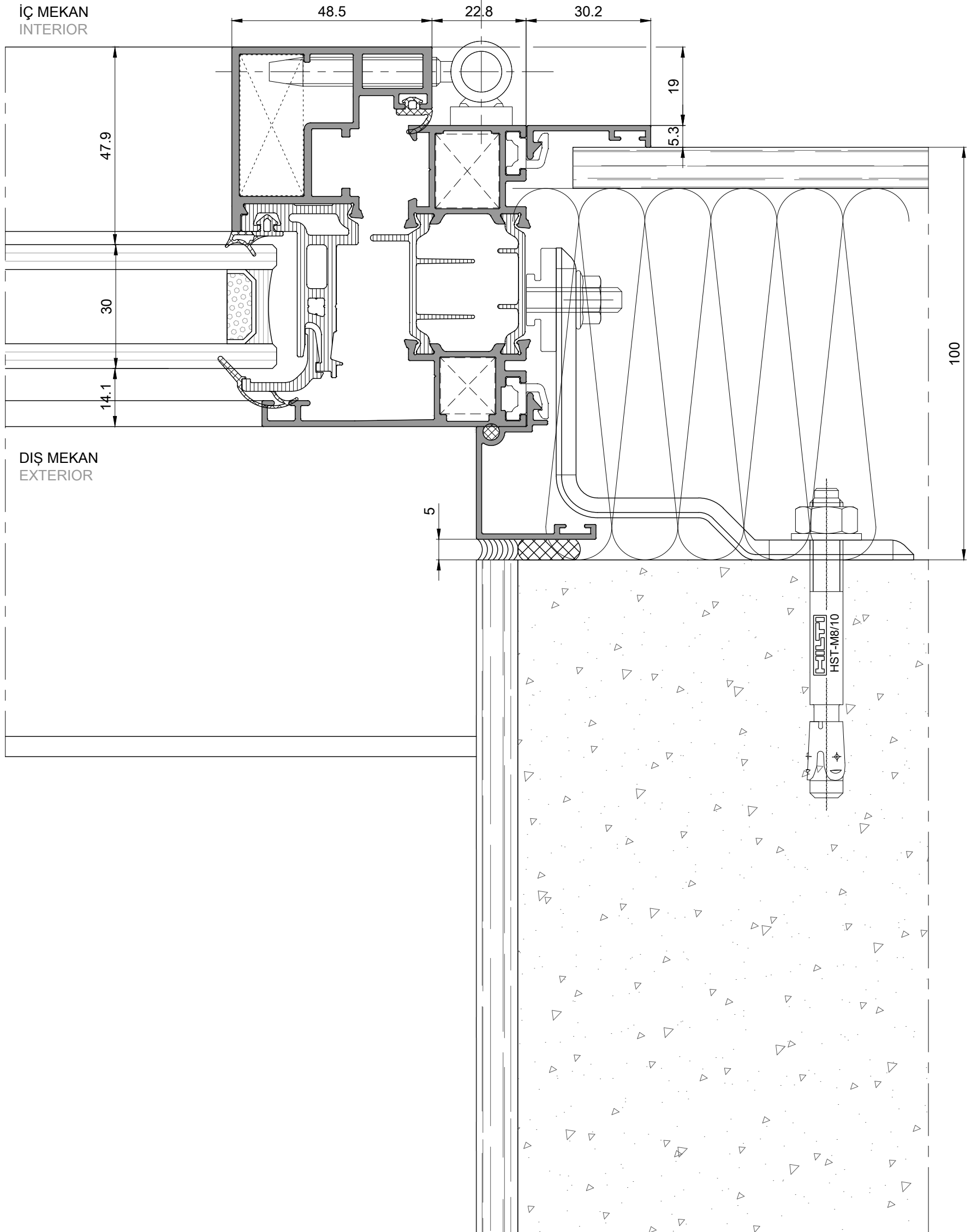
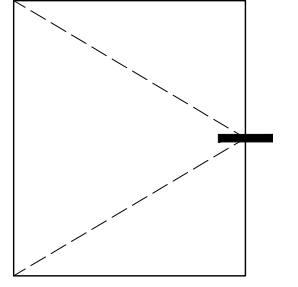

100mm YALITIMLI ÜST DETAY
100mm isolation with top side detail

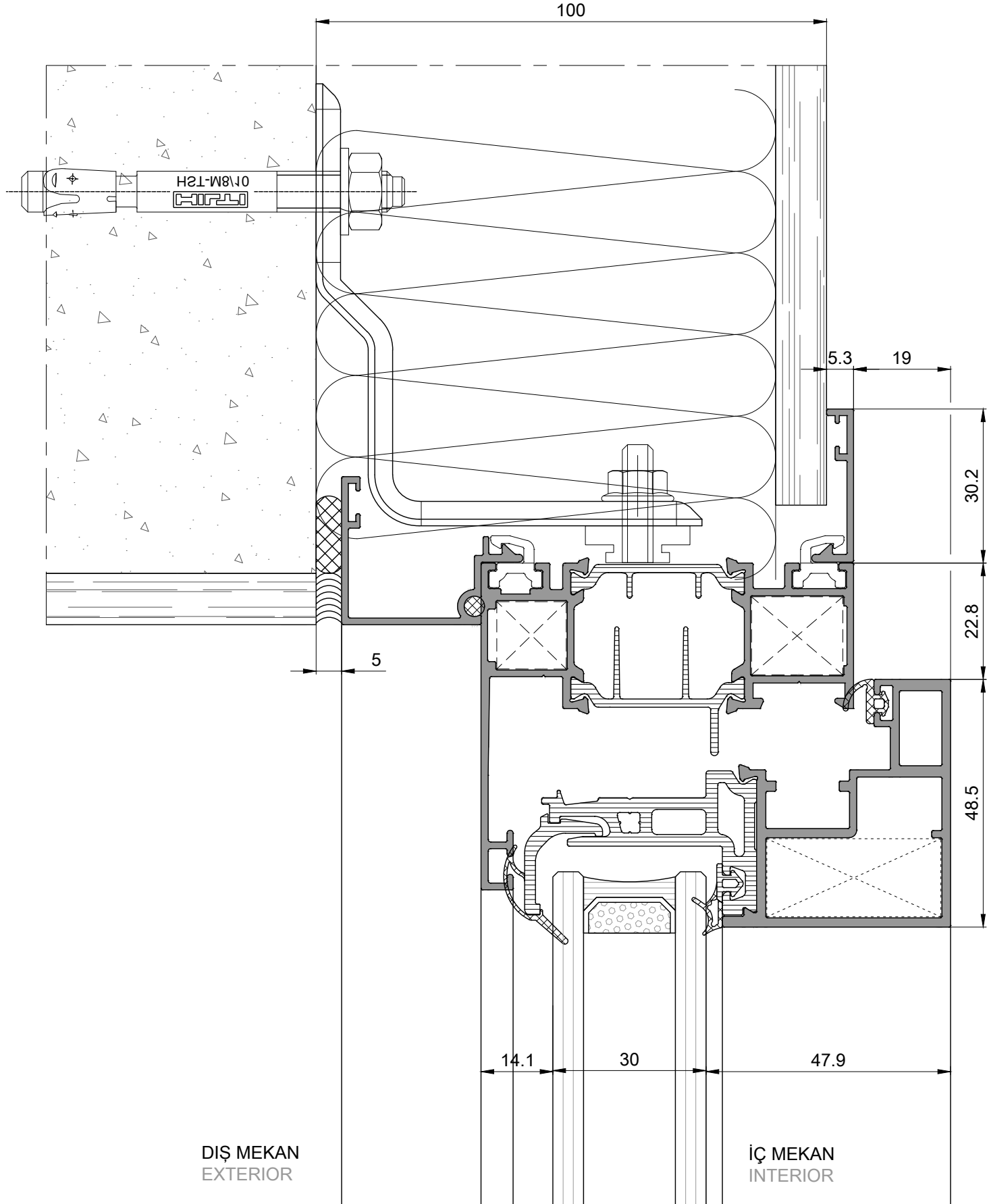
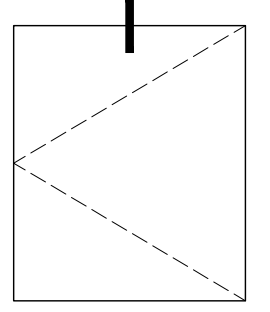

100mm YALITIMLI ÜST DETAY
100mm isolation with top side detail

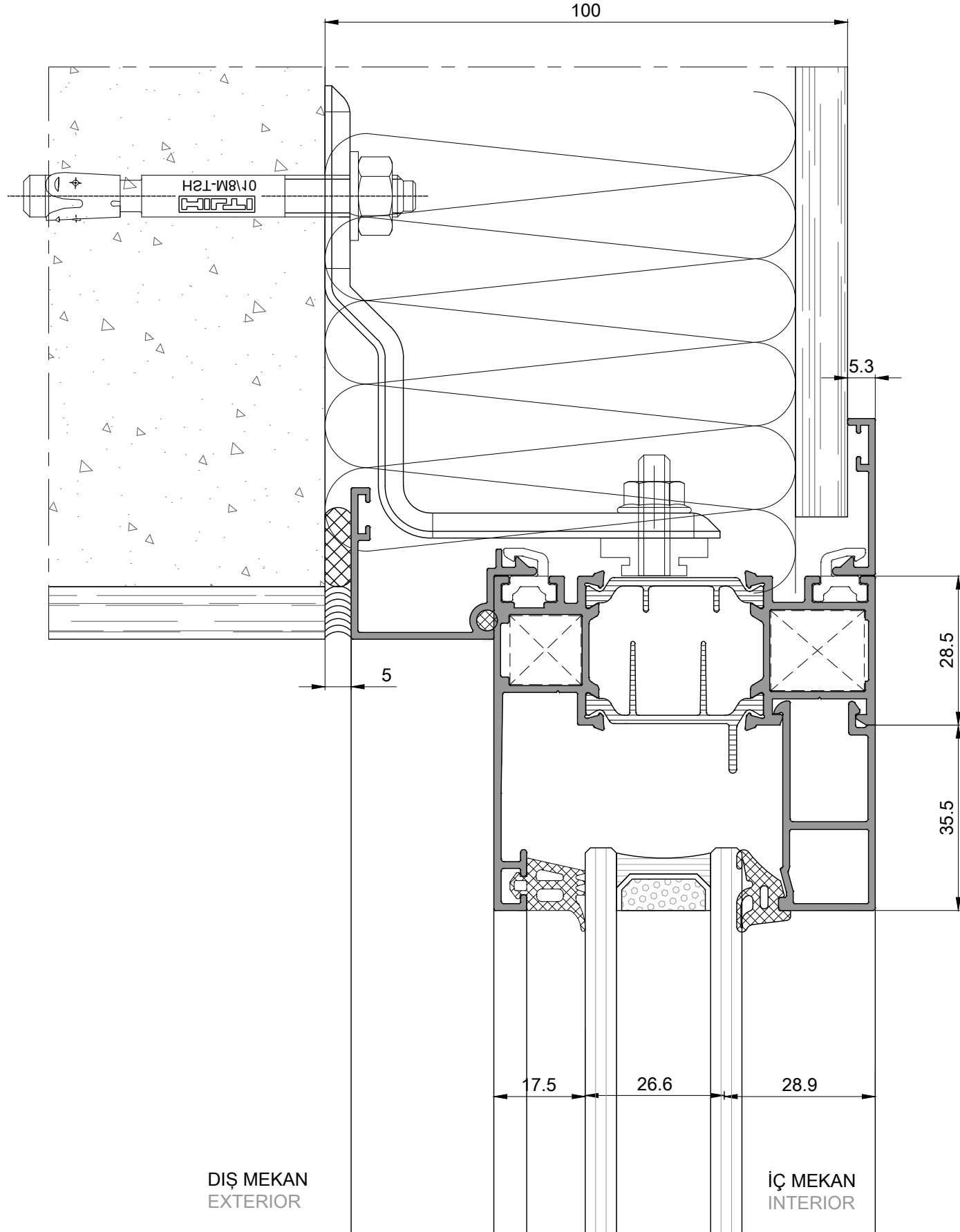
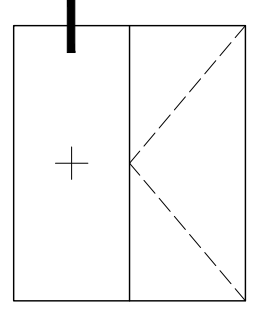

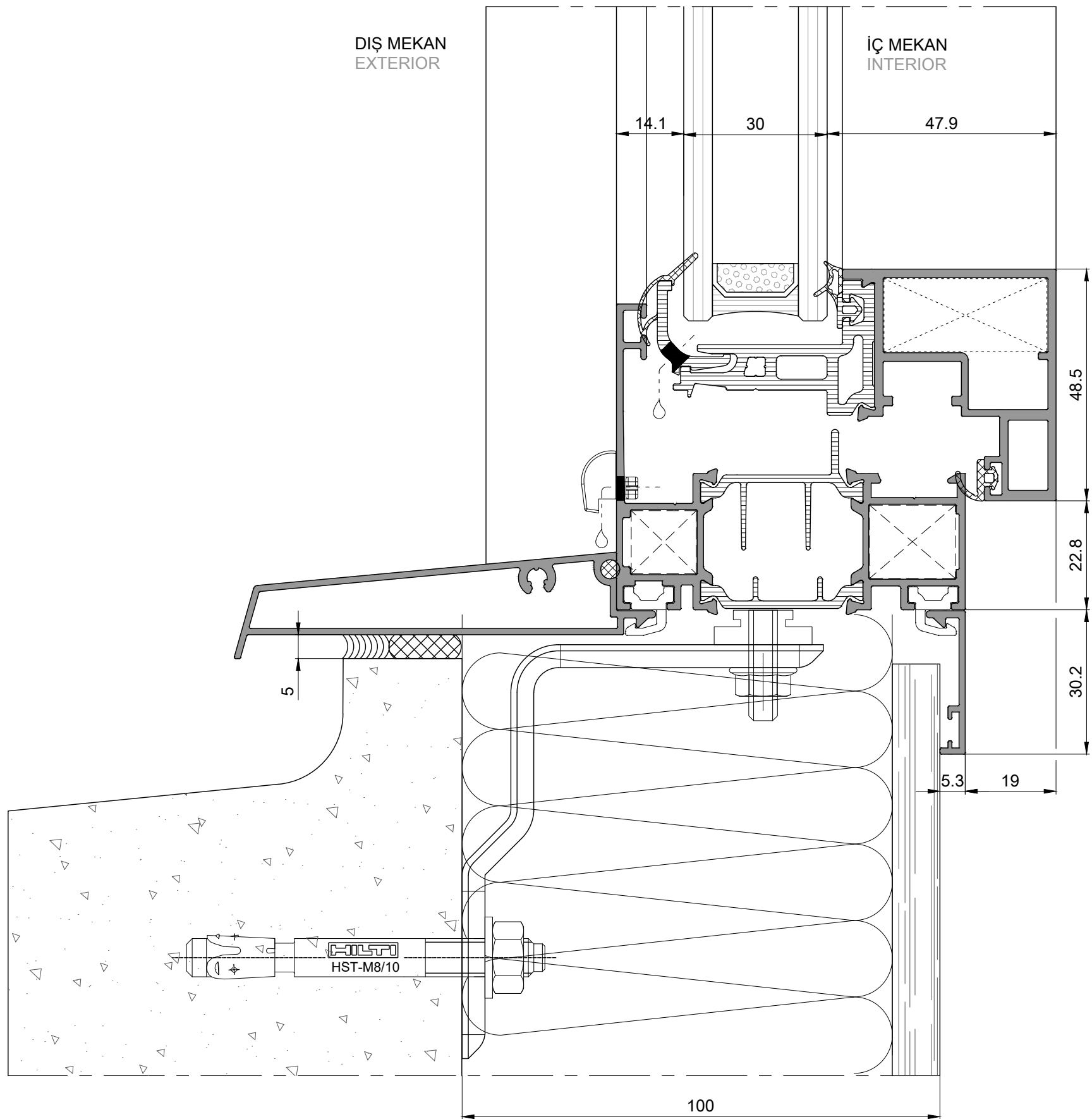
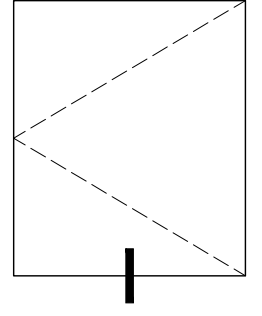

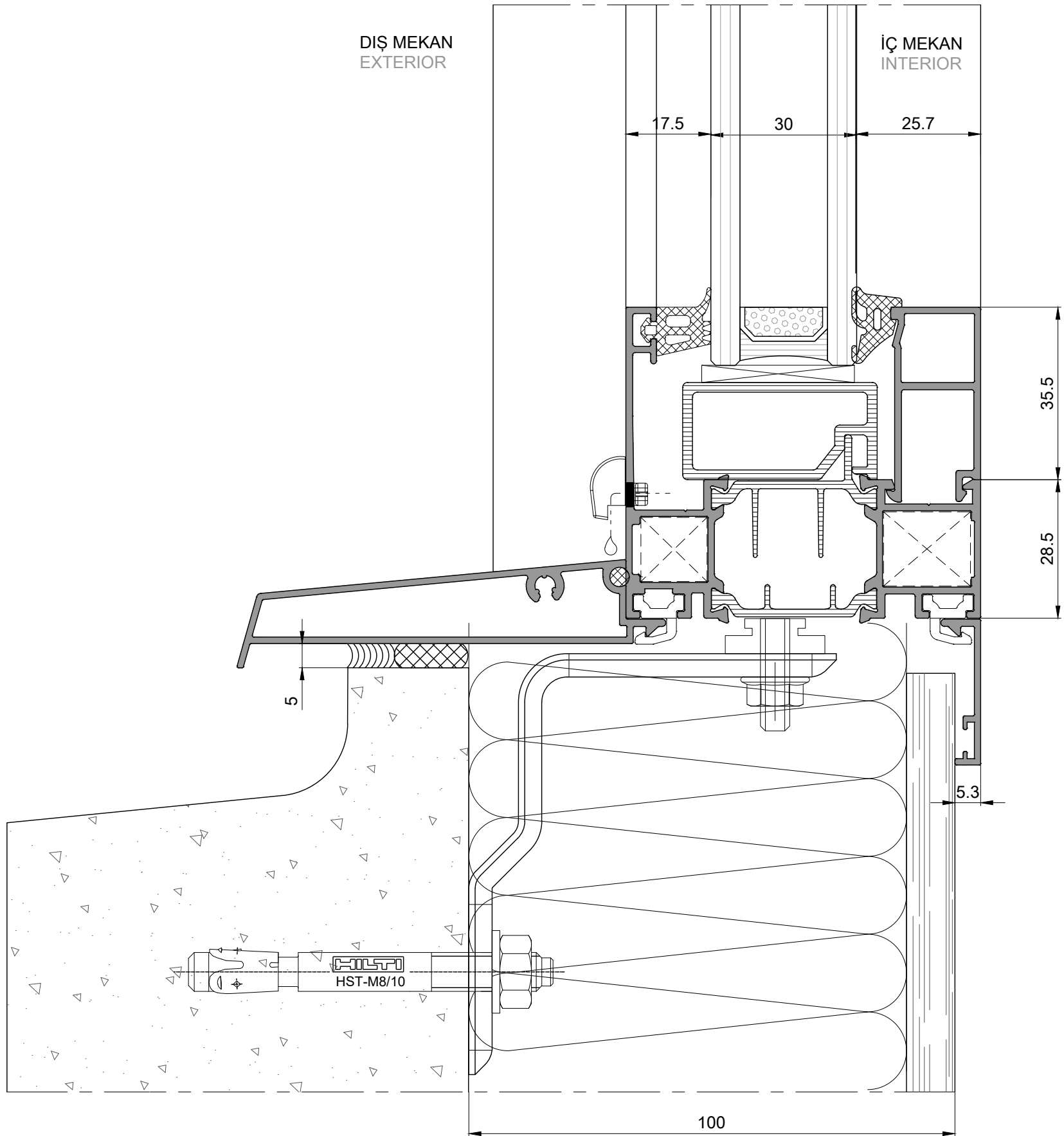
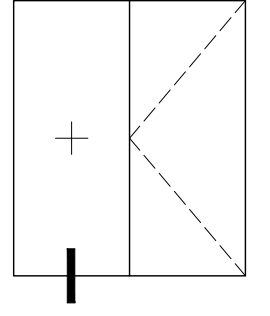

ALFA

GİZLİ KANATLI PENCERE ve KAPI SİSTEMİ CONCEALED SASH WINDOW and DOOR SYSTEM

GİZLİ KANATLI PENCERE DUVAR İÇİNE MONTAJ
PRENSİP SİSTEM DETAYLARI
PRINCIPAL SECTIONS for
CONCEALED SASH WINDOW
POSE CLASSIQUE EN TUNNEL

KLASİK MONTAJLI KASA YAN DETAY
pose classique en tunnel side detail

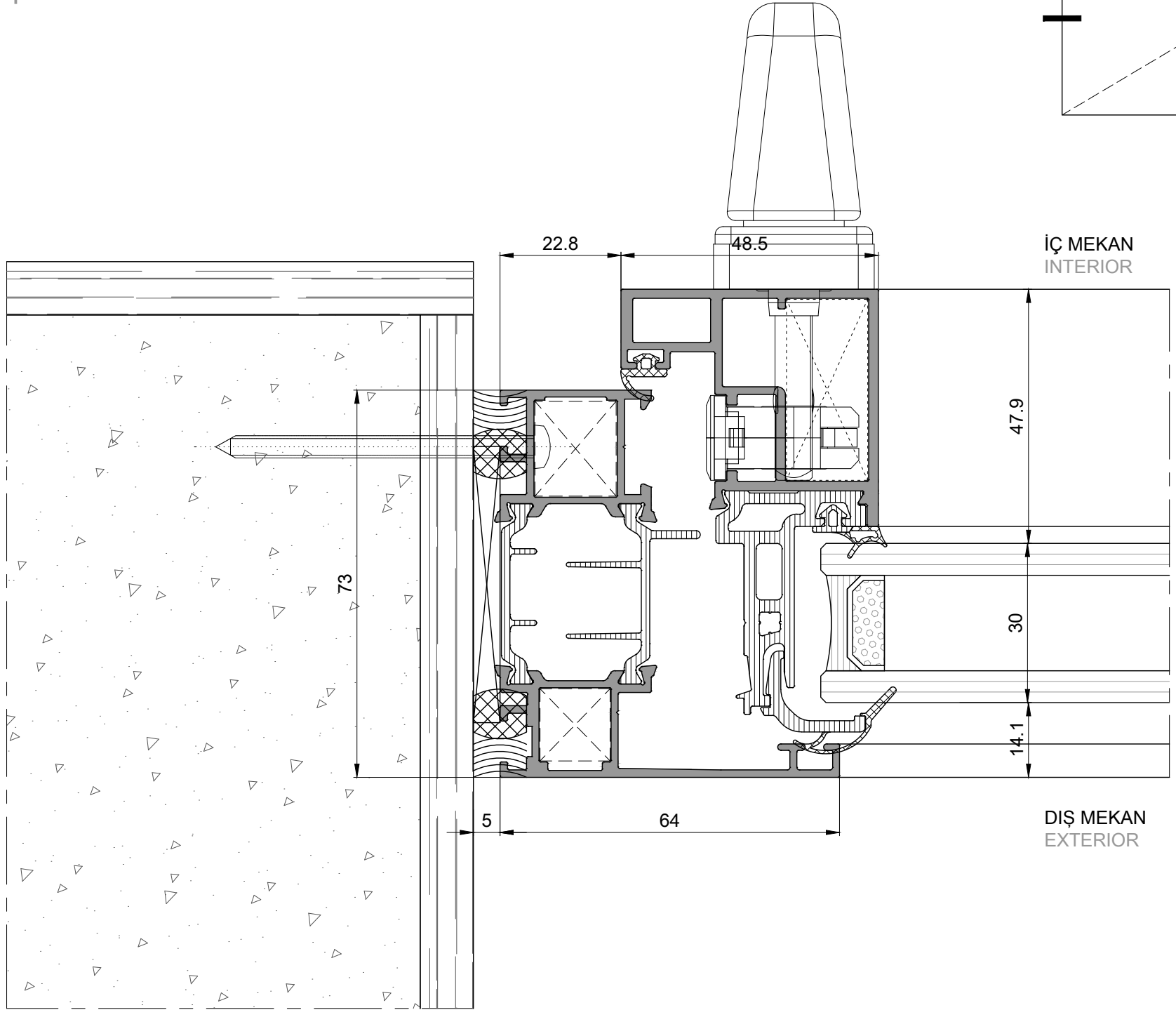
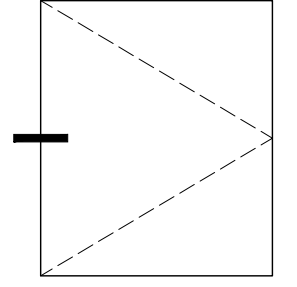

KLASİK MONTAJLI KASA YAN DETAY
pose classique en tunnel side detail

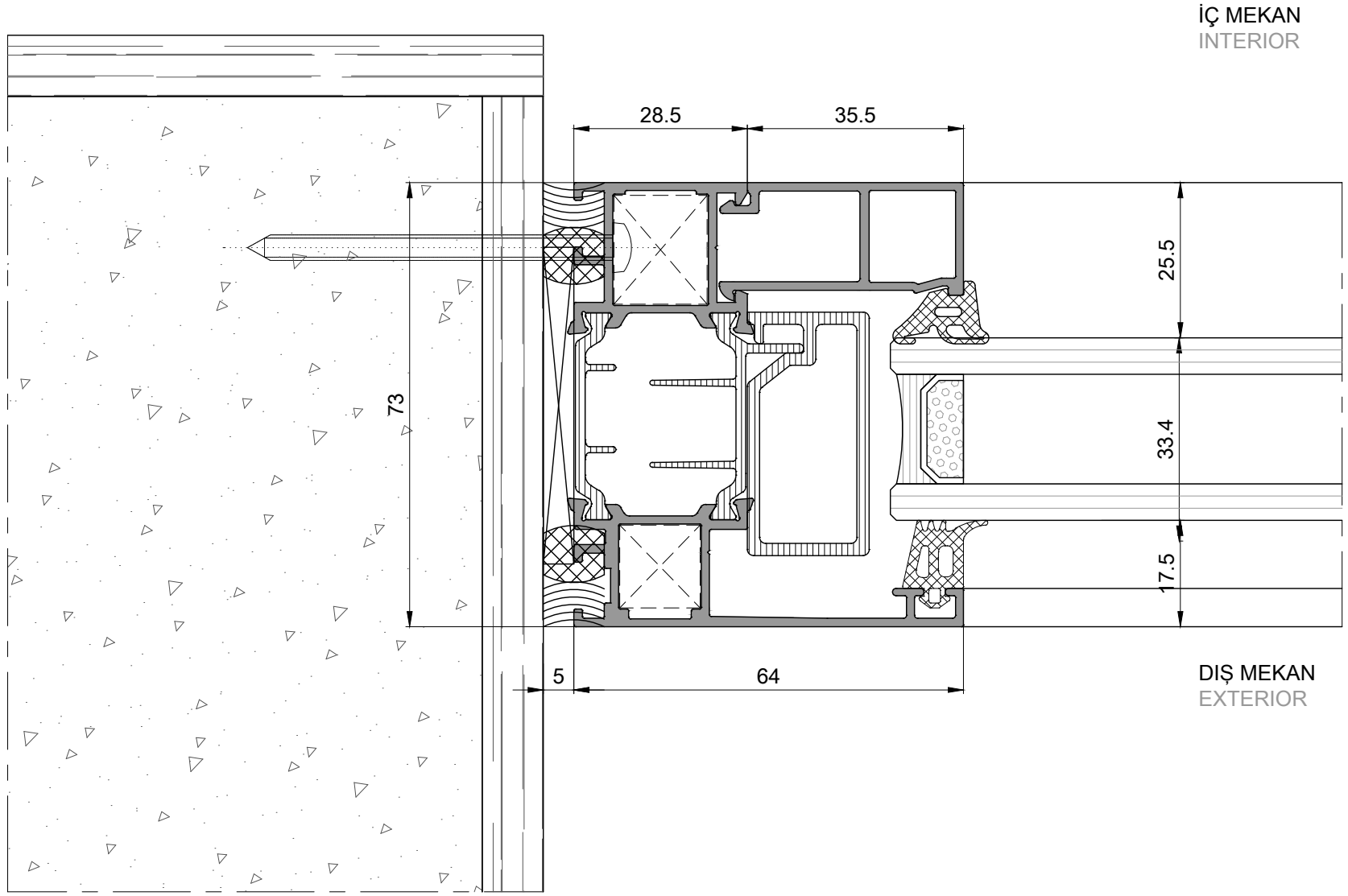
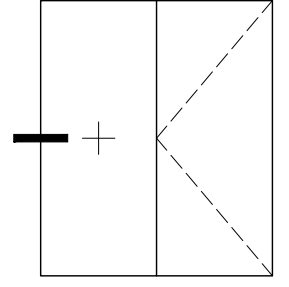

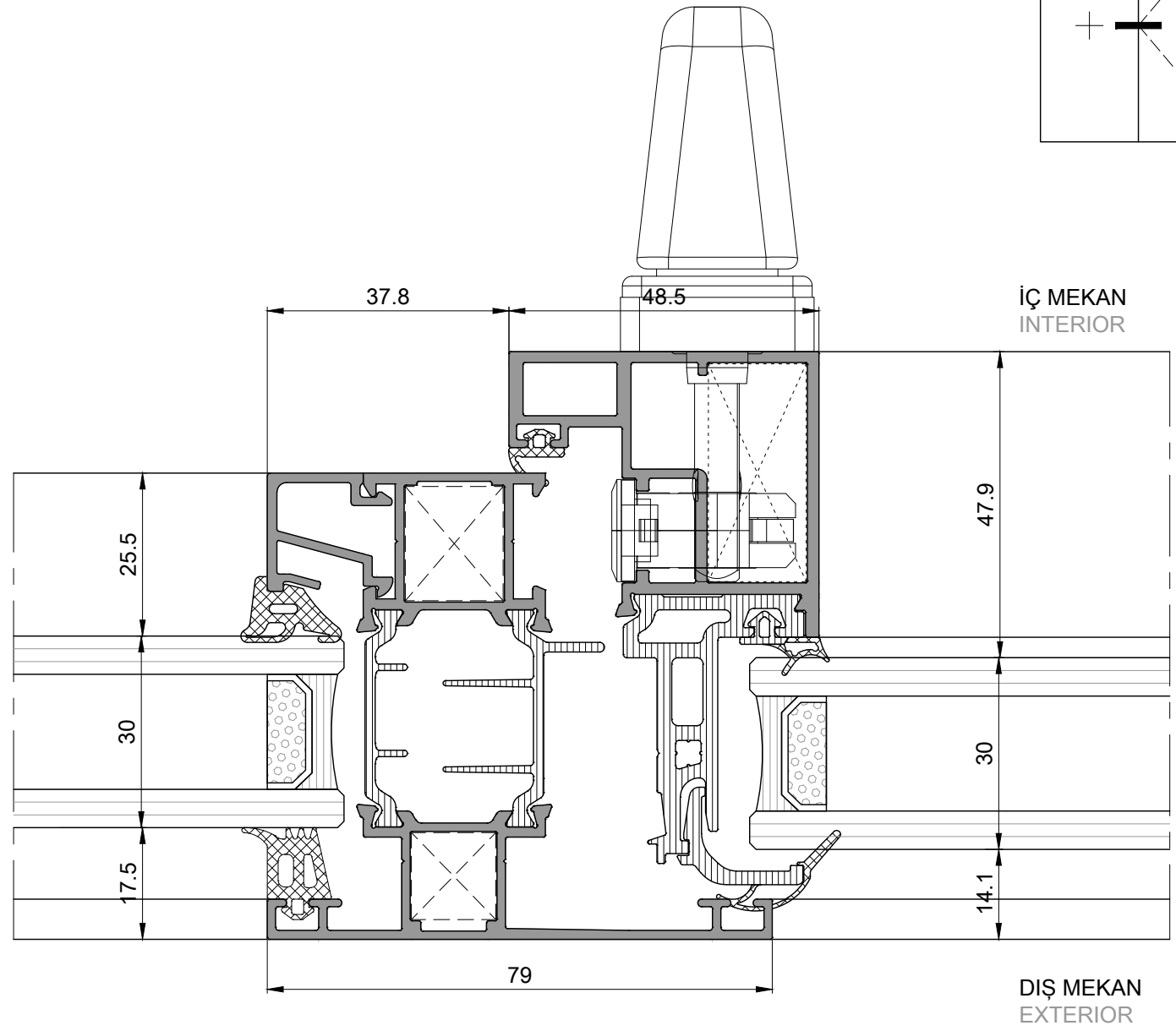
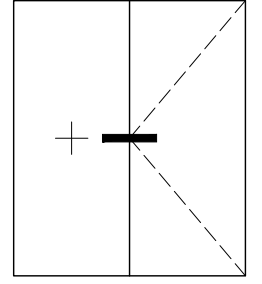

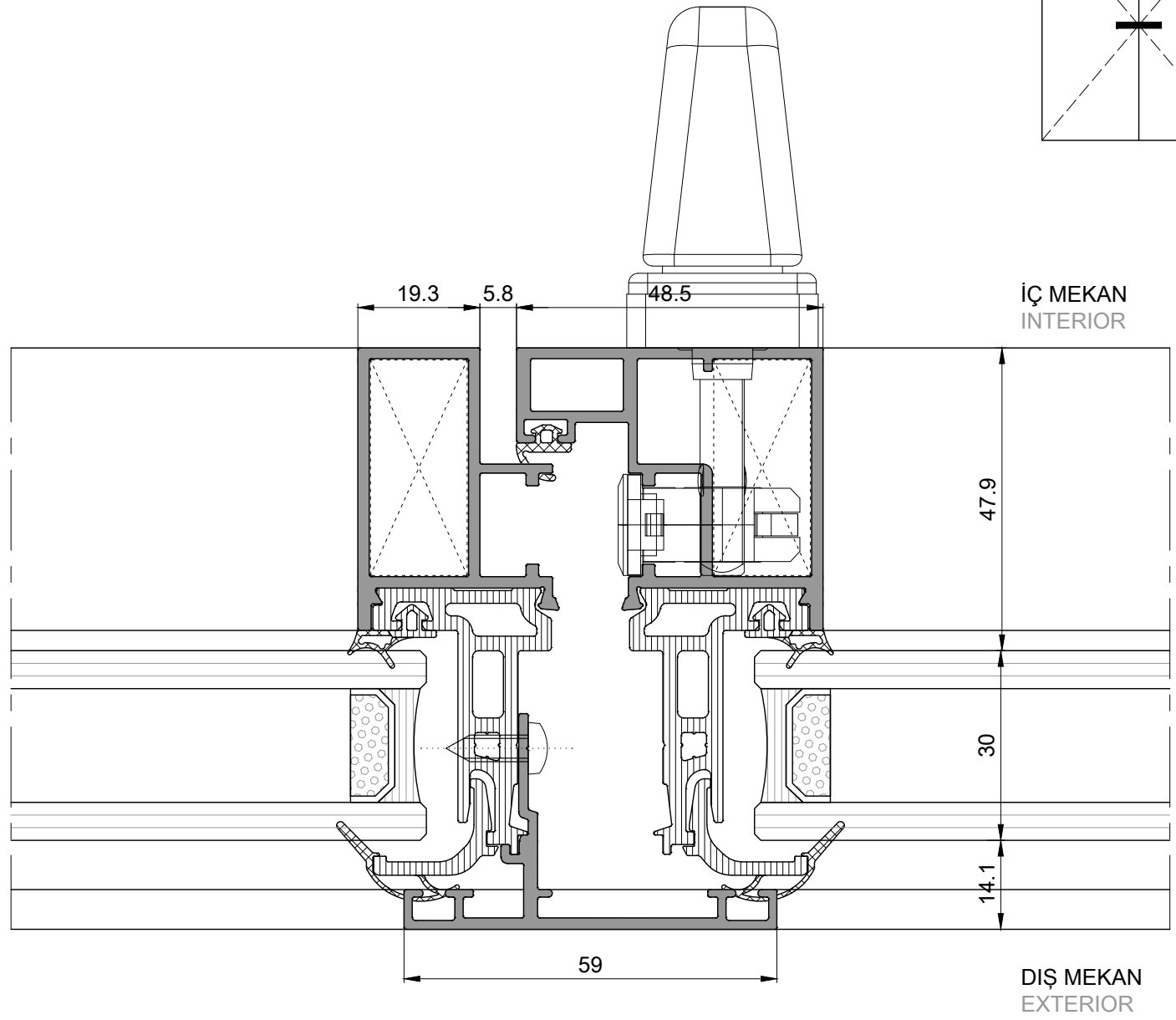
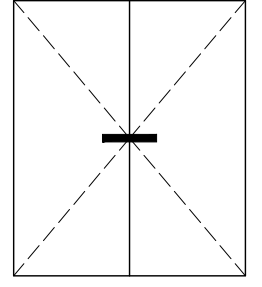

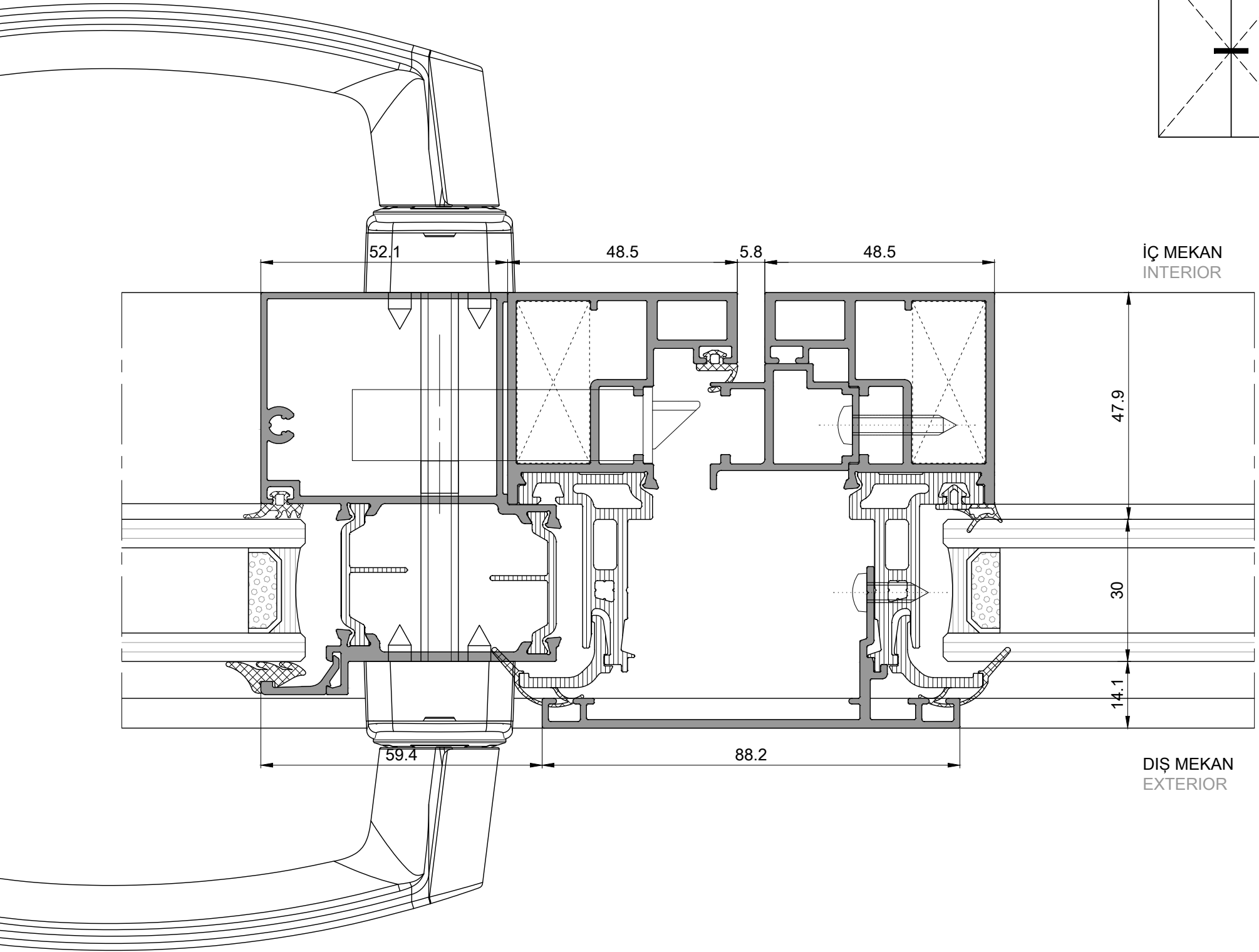
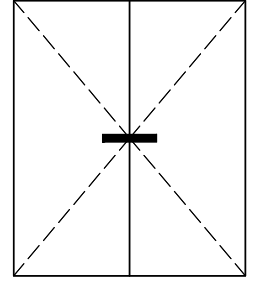

KLASİK MONTAJLI KASA YAN DETAY
pose classique en tunnel side detail

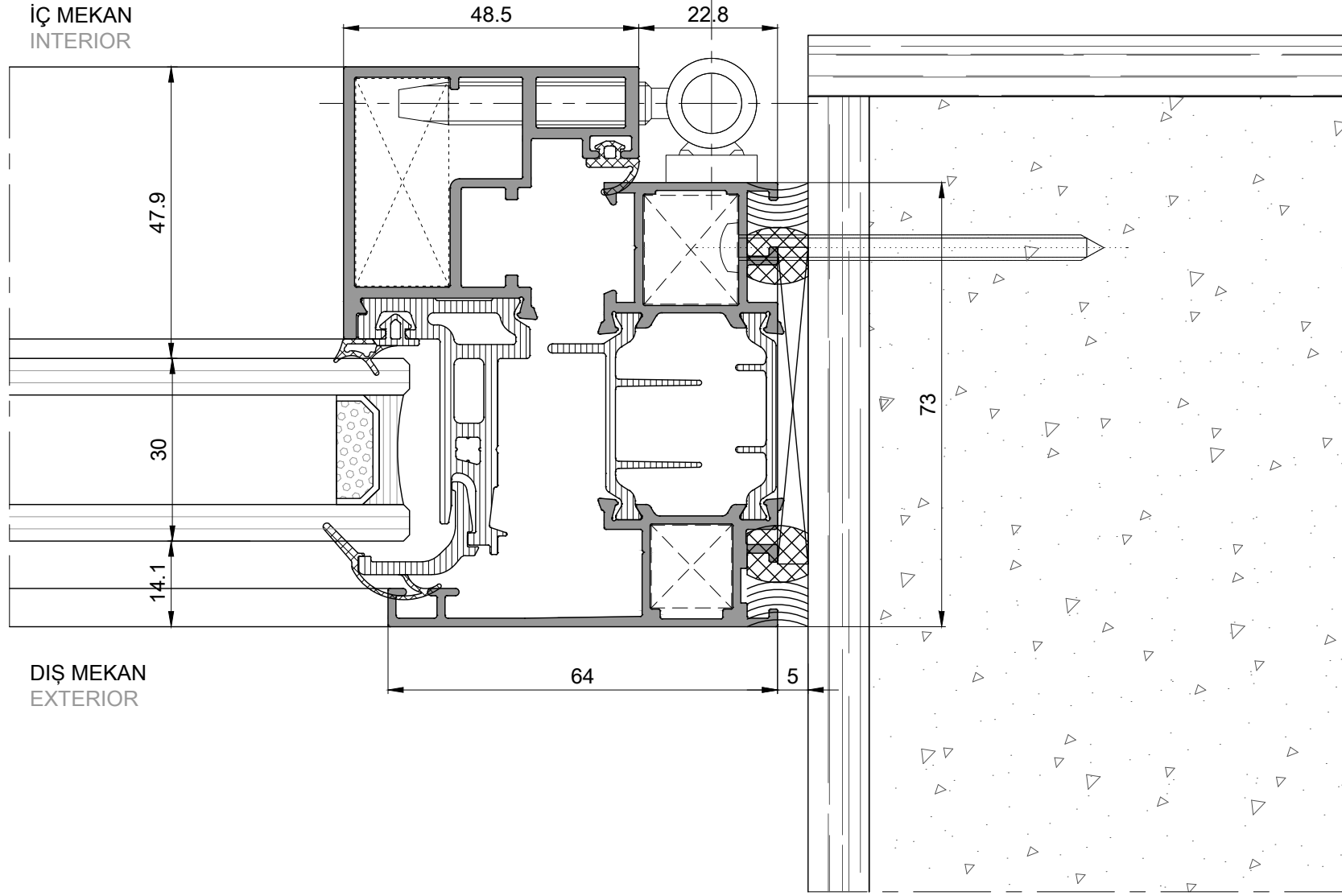
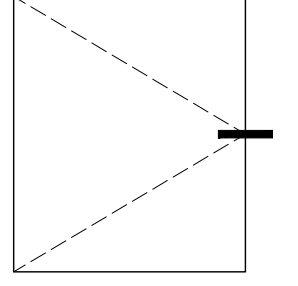

KLASİK MONTAJLI KASA ÜST DETAY
pose classique en tunnel top detail

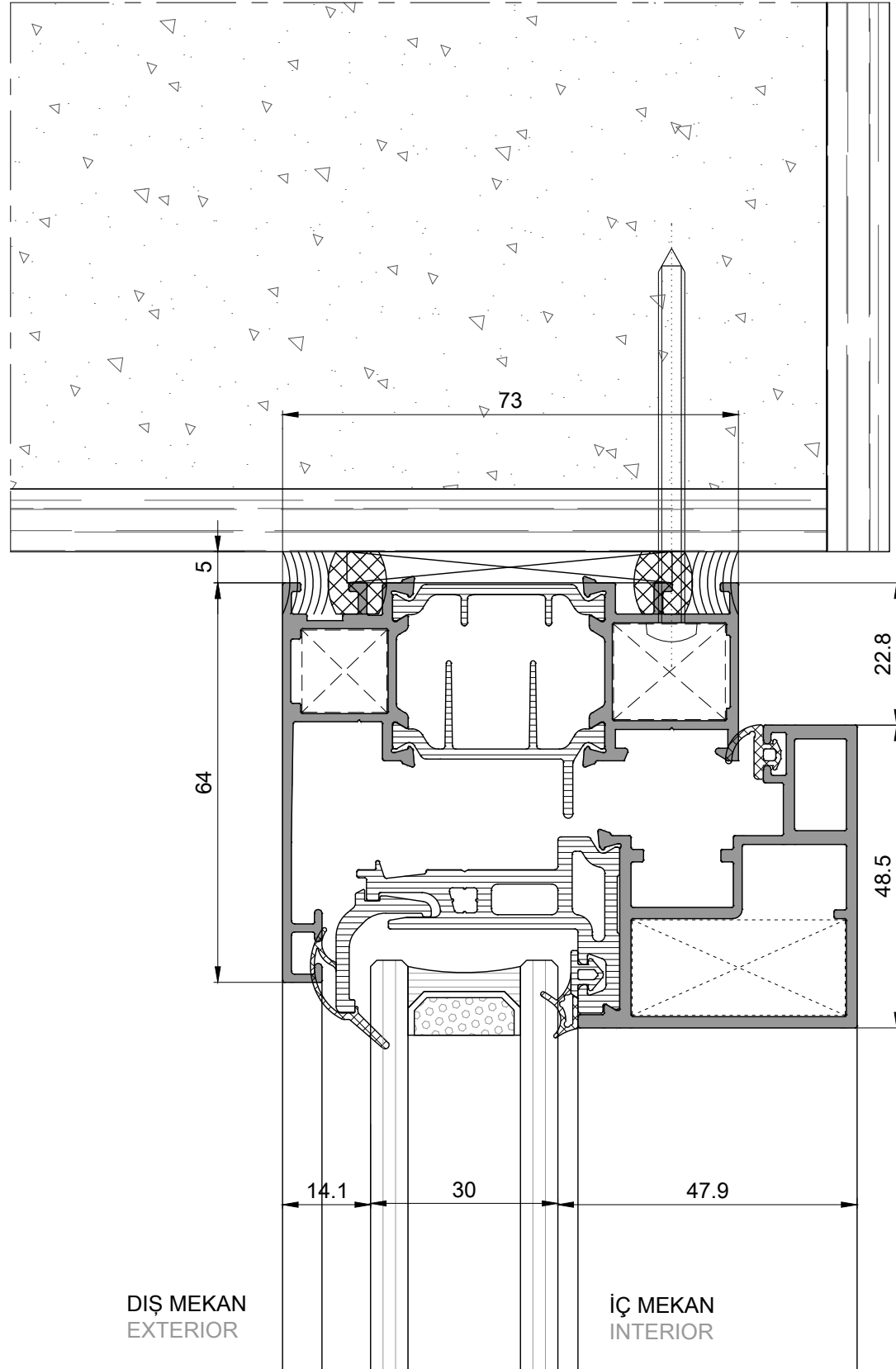
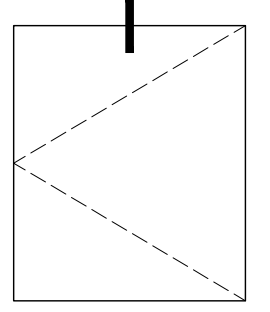

KLASİK MONTAJLI KASA ÜST DETAY
pose classique en tunnel top detail

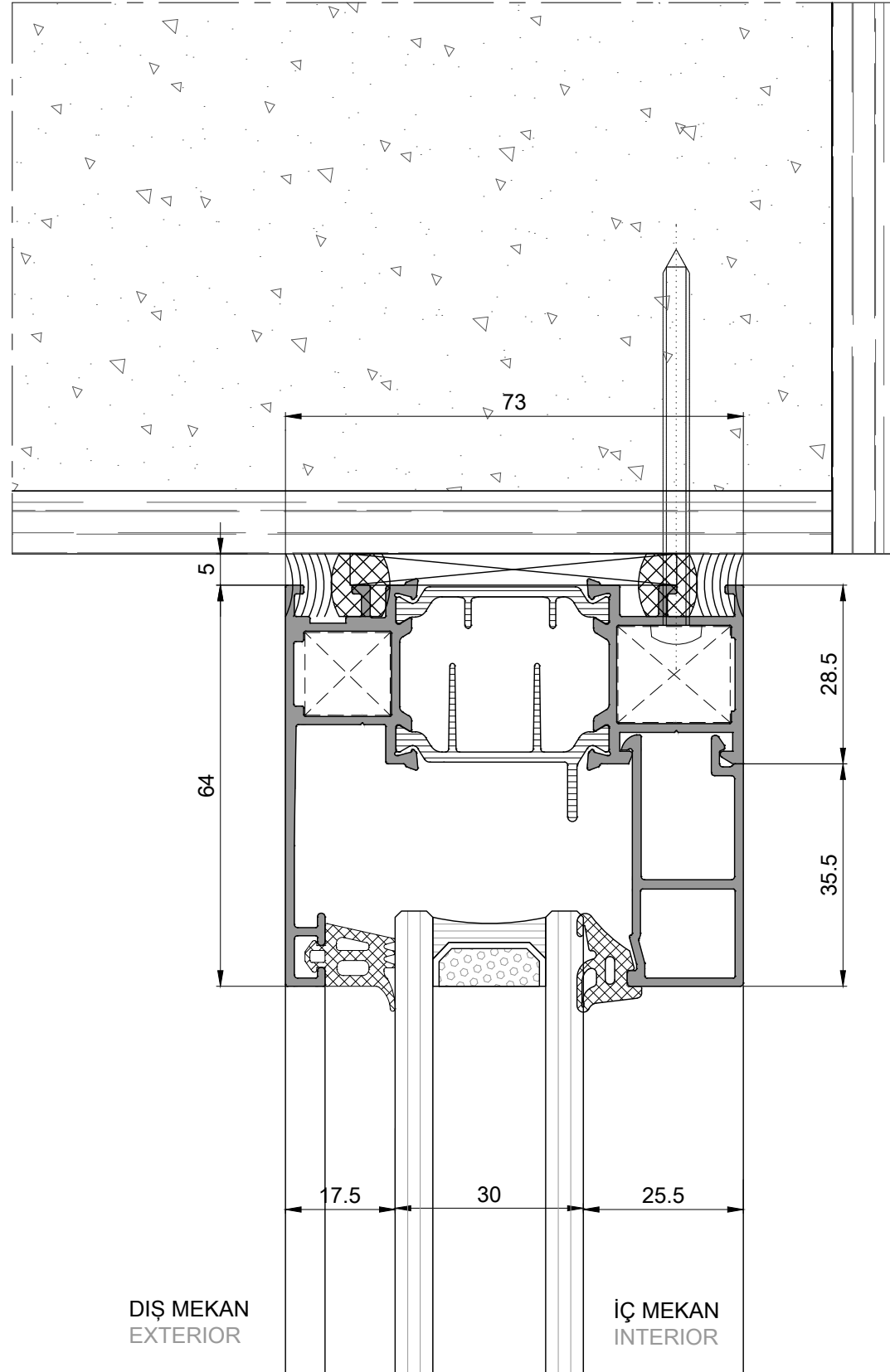
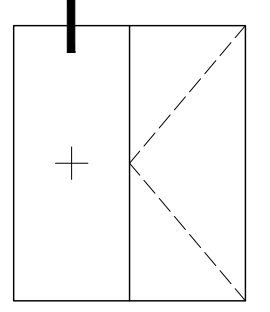

KLASİK MONTAJLI KASA ALT DETAY
pose classique en tunnel bottom detail

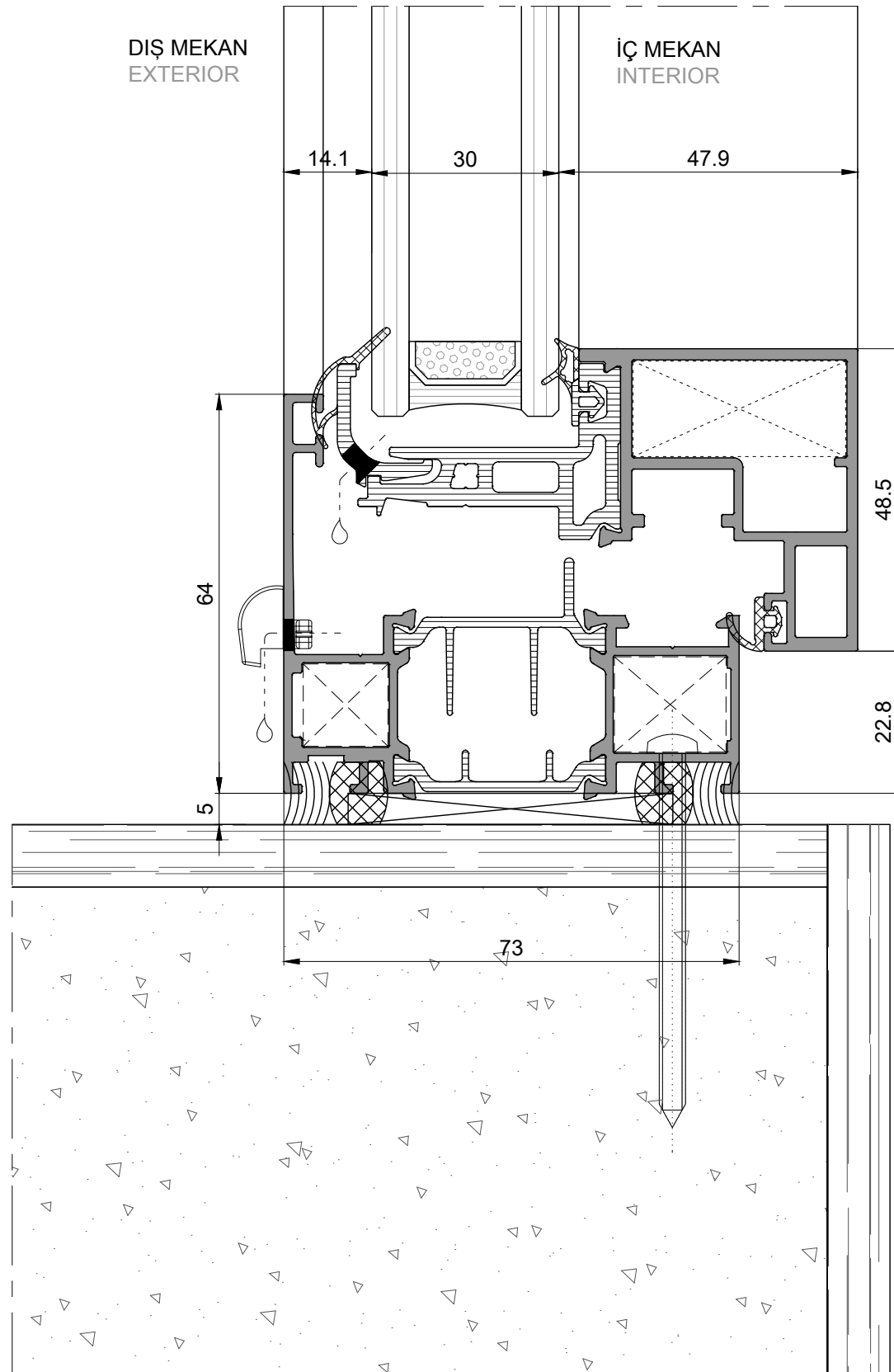
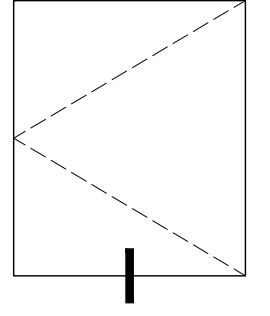

KAPI ALT EŞİK DETAY
Door bottom side threshold detail

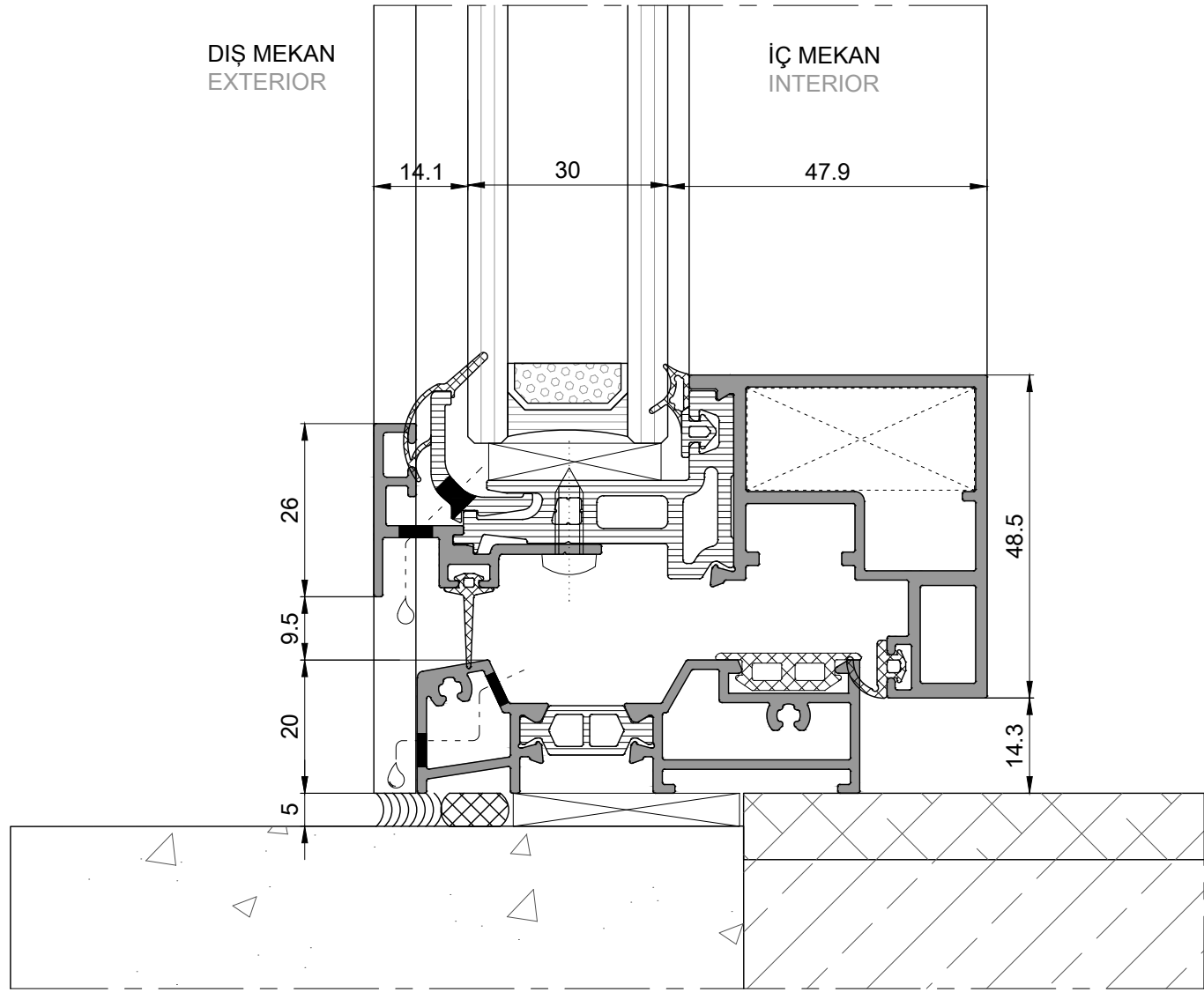
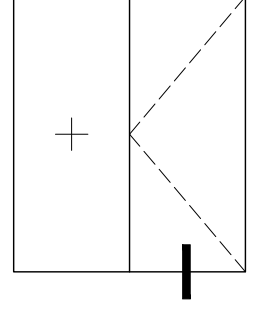

SABİT ALT DETAY
fixed glass bottom detail

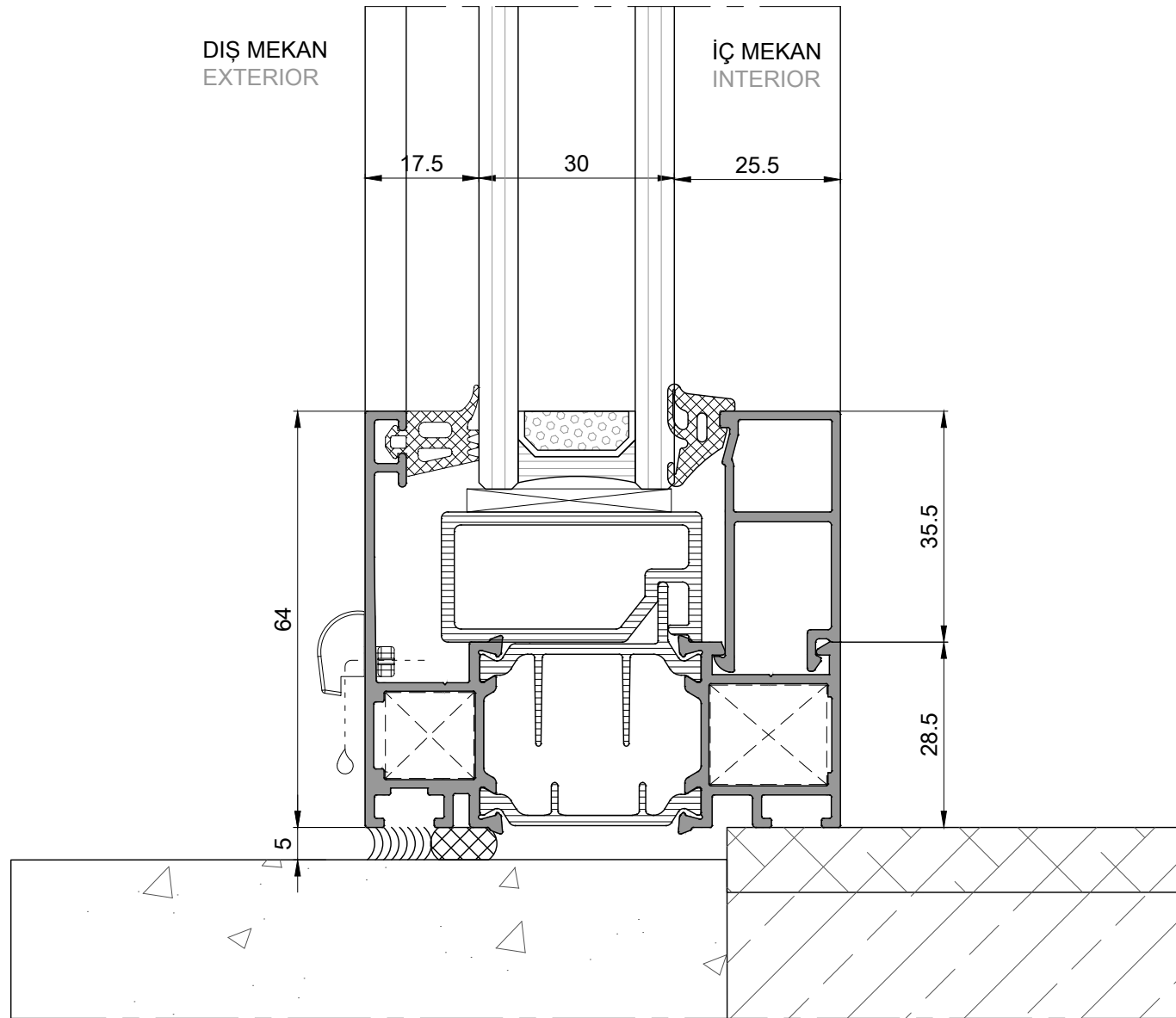
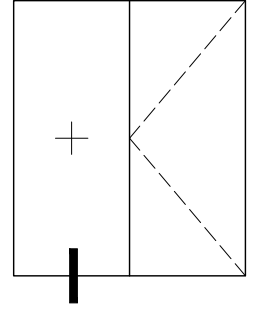

ALFA

GİZLİ KANATLI PENCERE ve KAPI SİSTEMİ CONCEALED SASH WINDOW and DOOR SYSTEM

YENİLEME KASA İLE GİZLİ KANATLI PENCERE PRENSİP SİSTEM DETAYLARI PRINCIPAL SECTIONS for CONCEALED SASH WINDOW RENOVATION

KLASİK MONTAJLI KASA YAN DETAY
pose classique en tunnel side detail

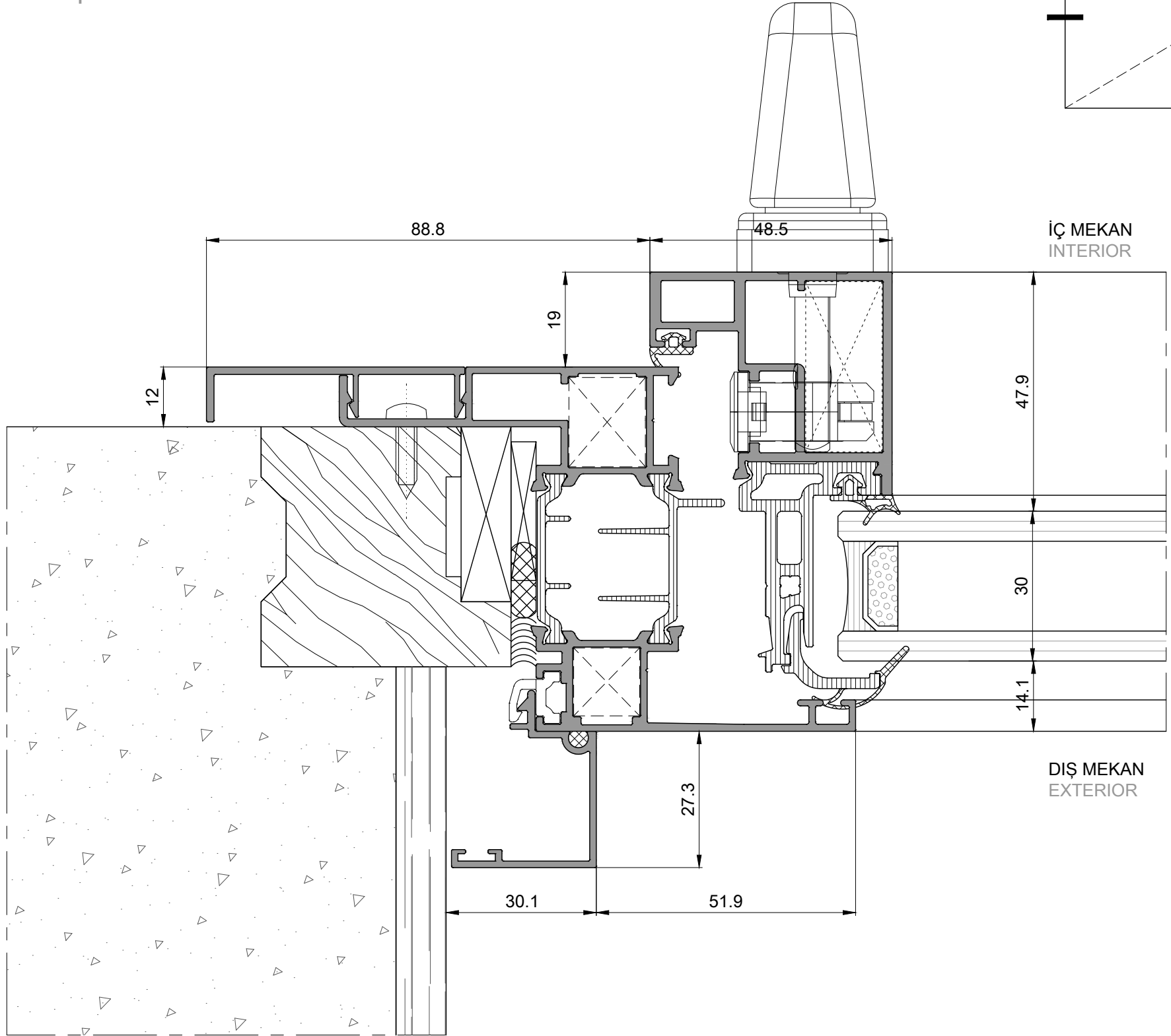

KLASİK MONTAJLI KASA YAN DETAY
pose classique en tunnel side detail

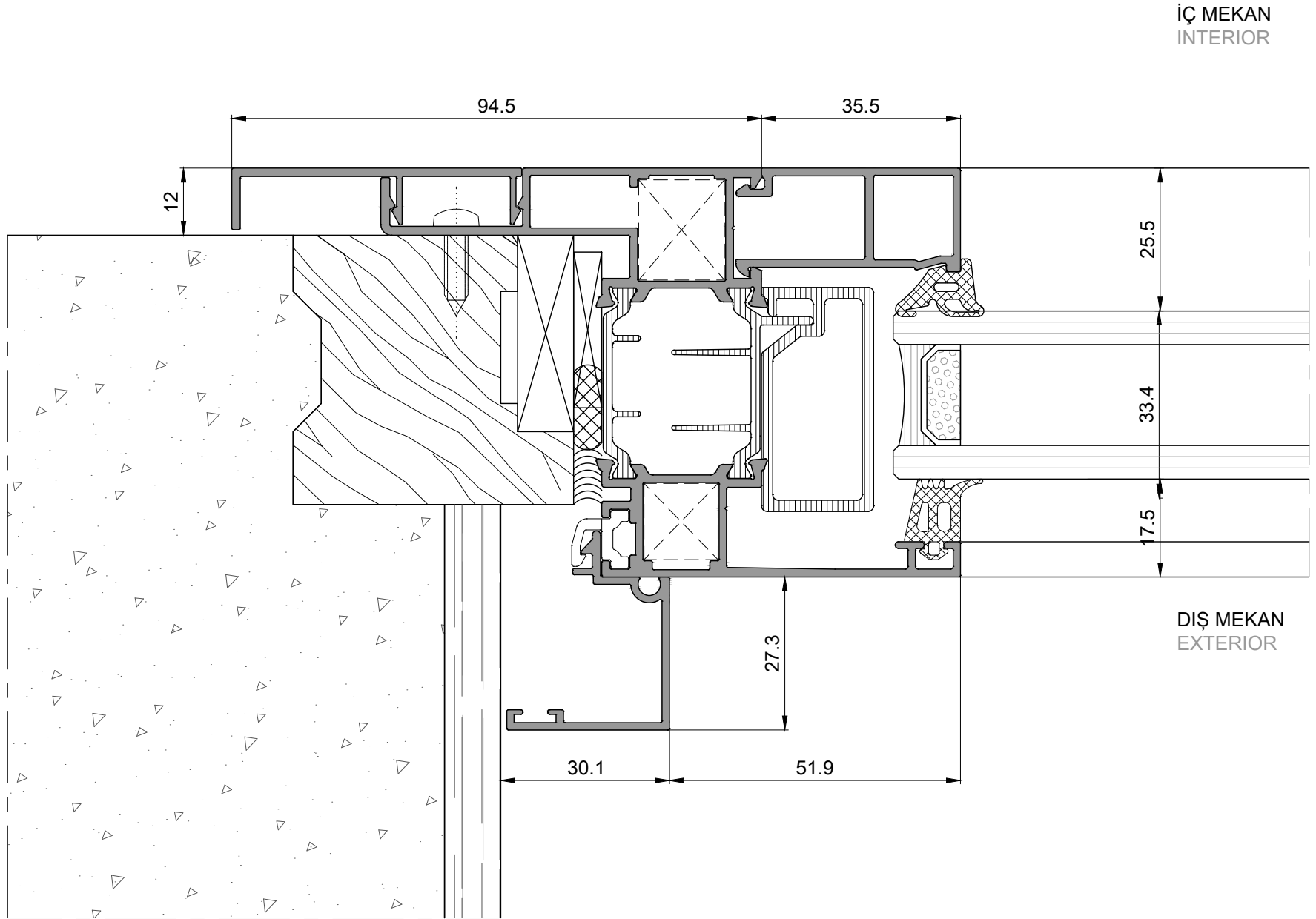
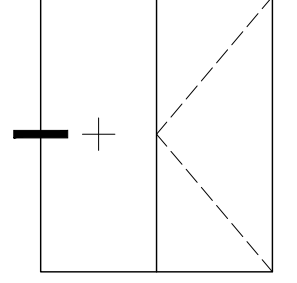

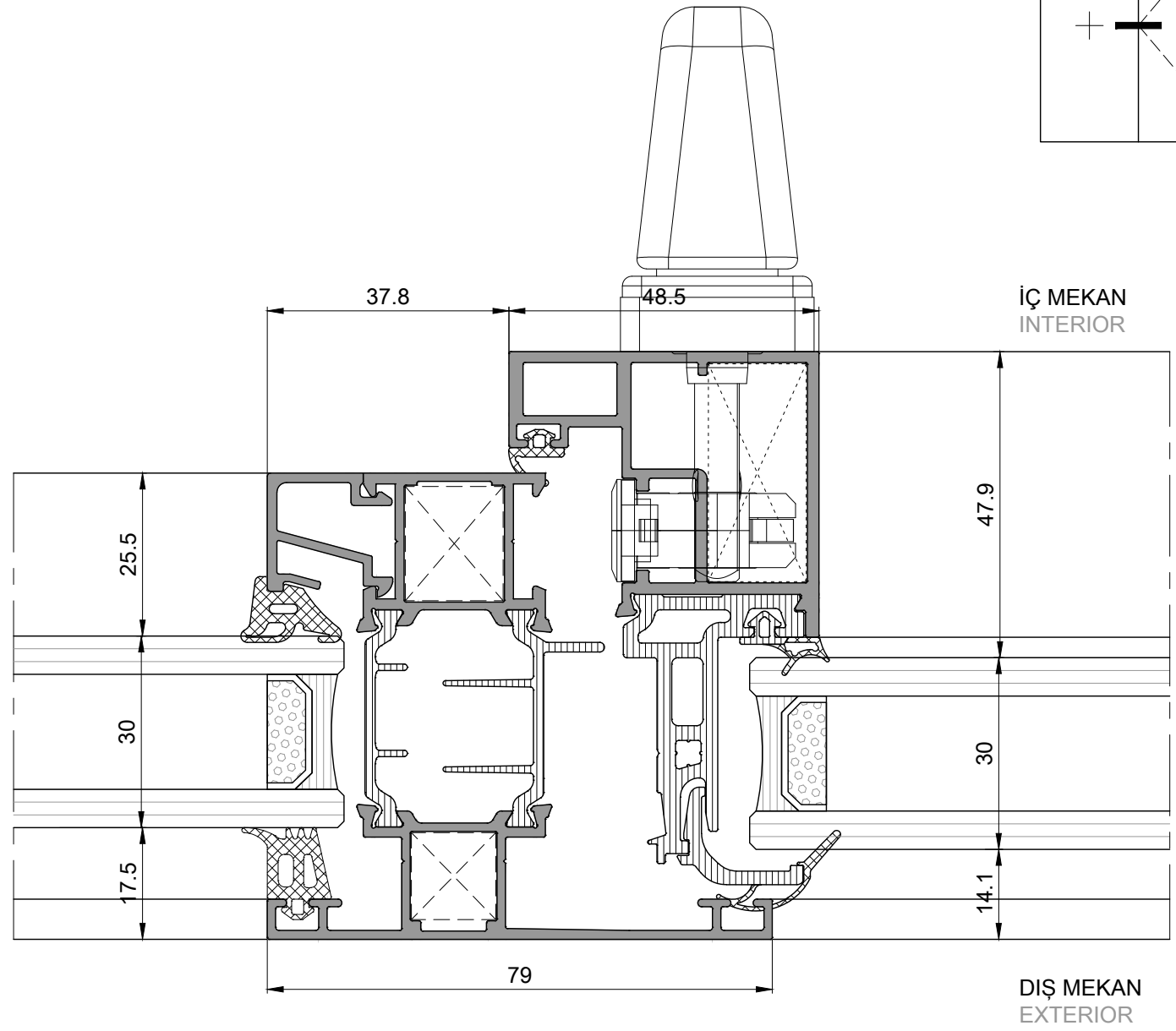
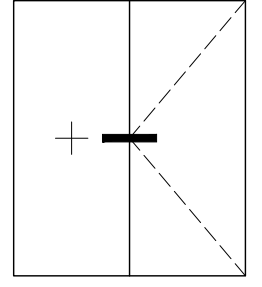

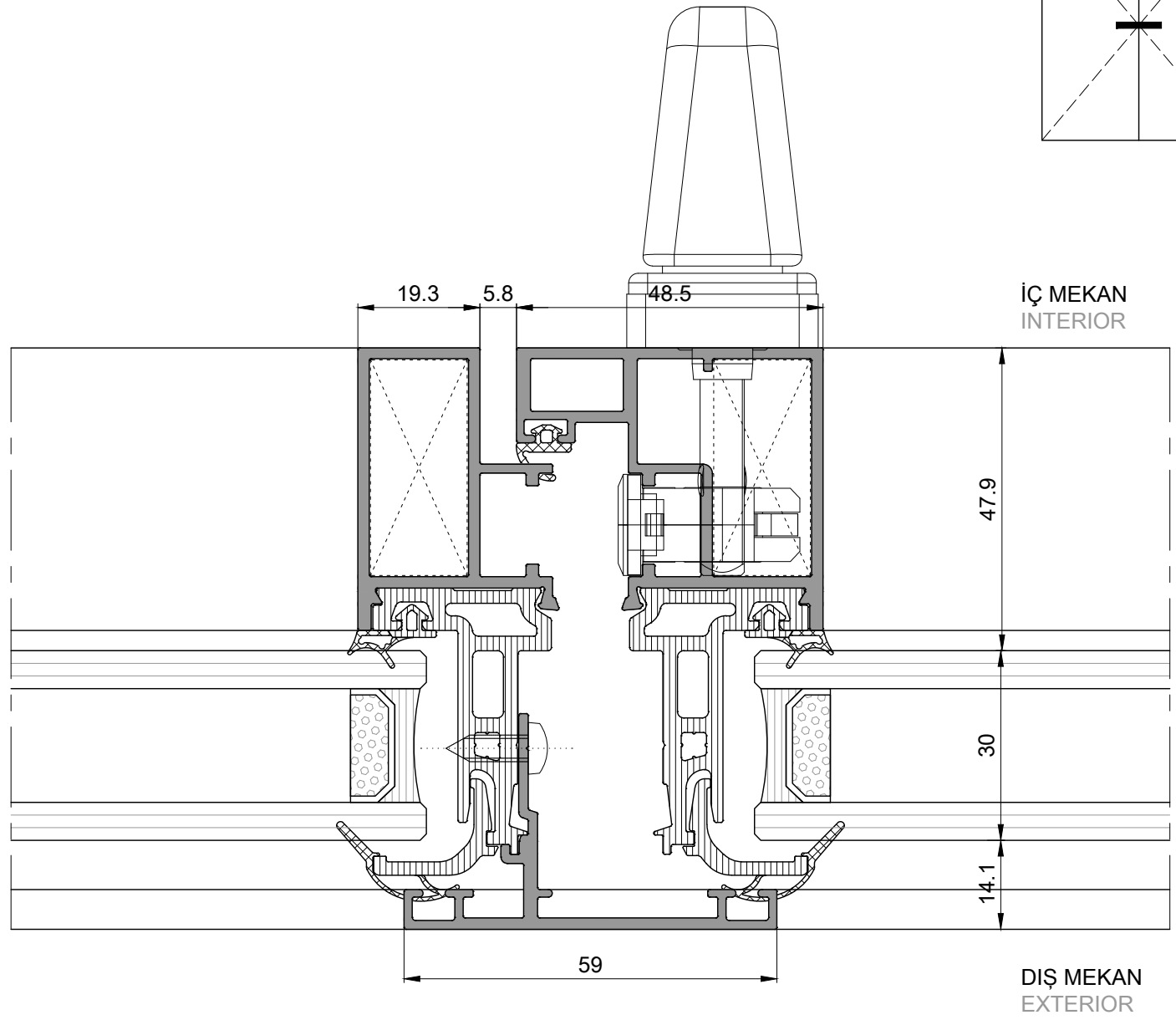
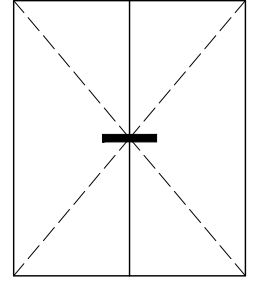

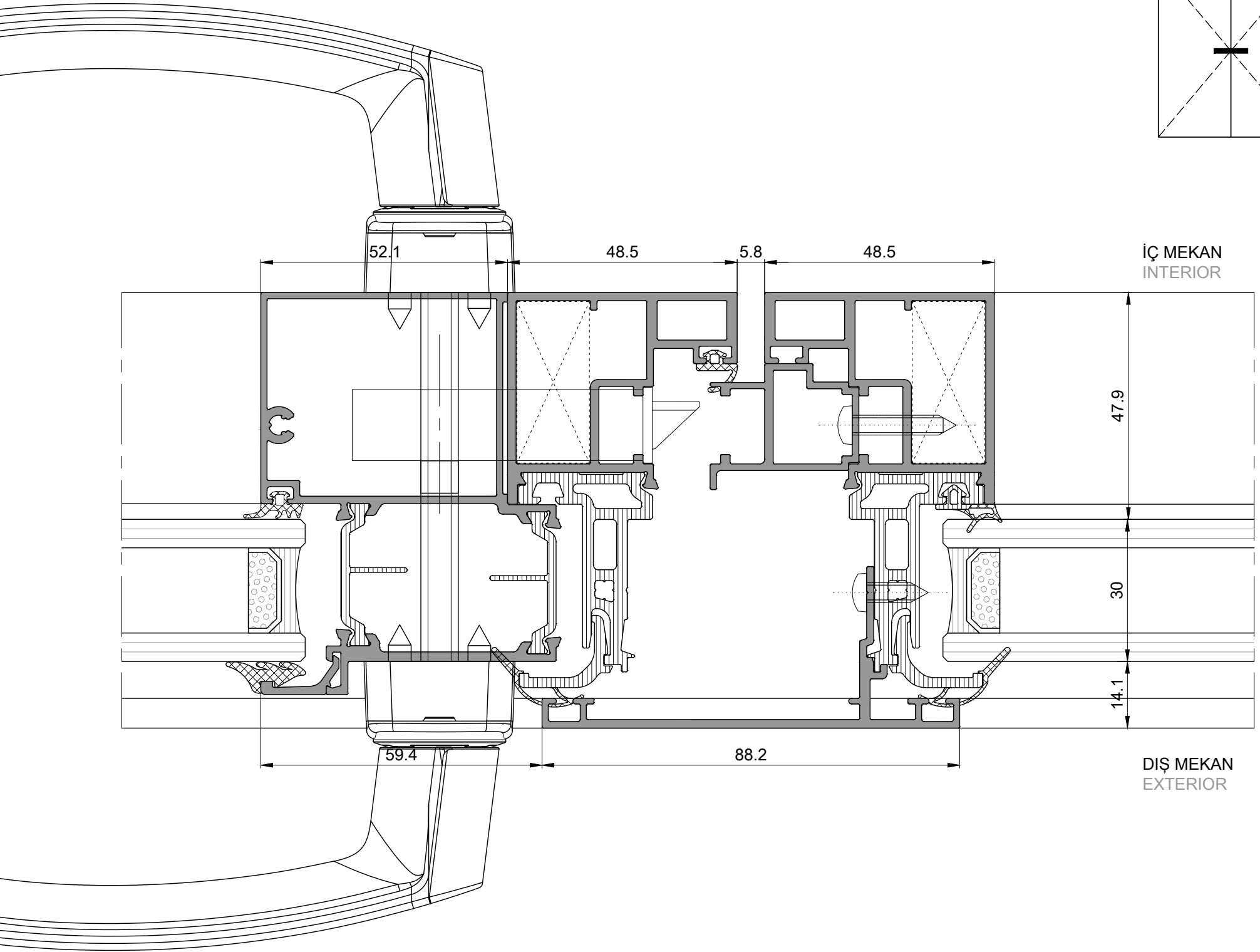
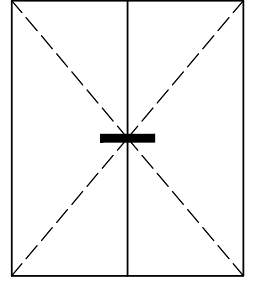

KLASİK MONTAJLI KASA YAN DETAY
pose classique en tunnel side detail

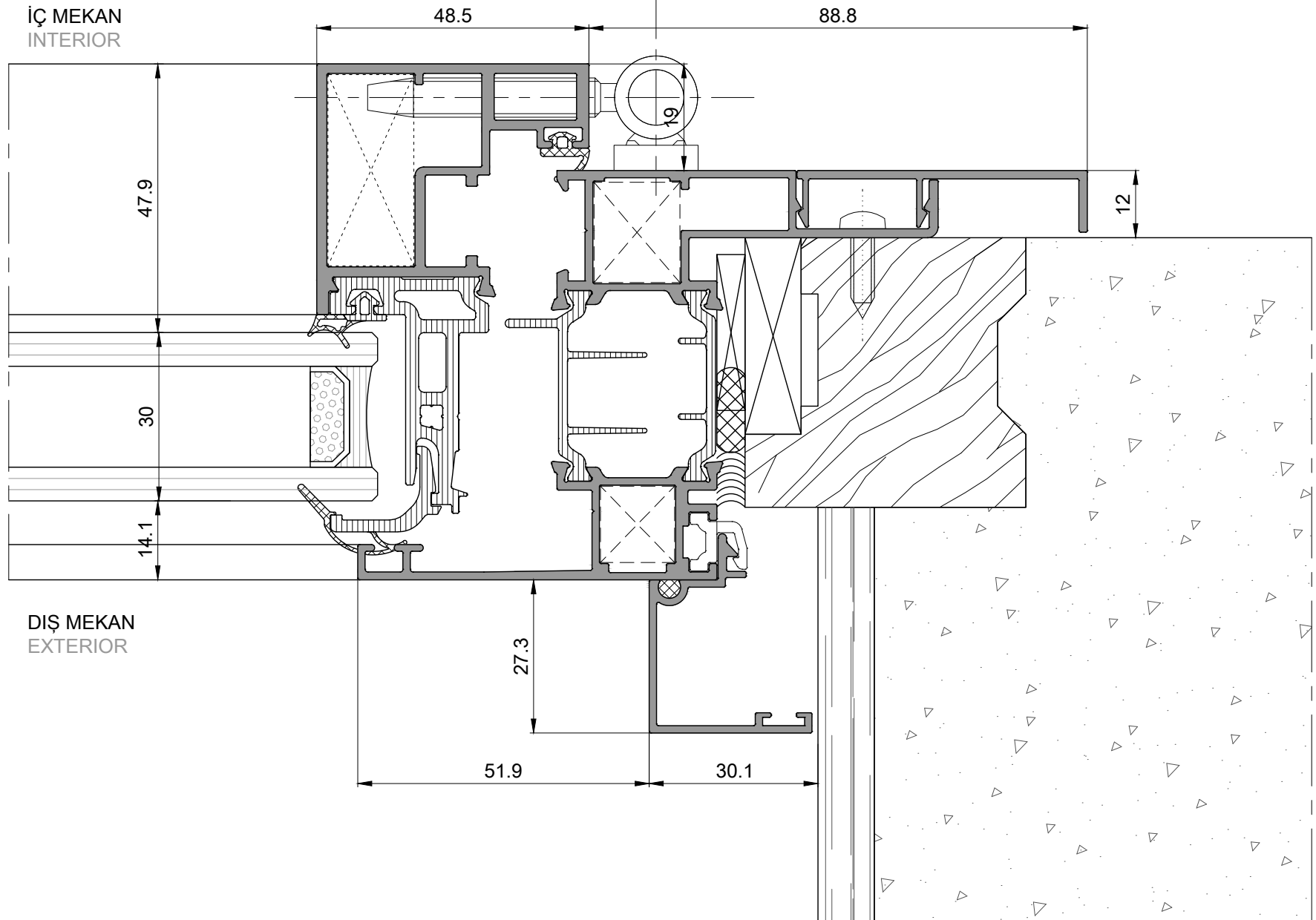
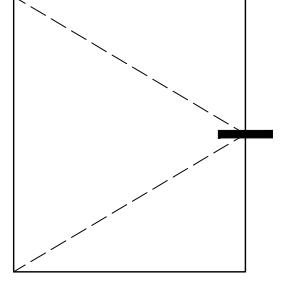

KLASİK MONTAJLI KASA ÜST DETAY
pose classique en tunnel top detail

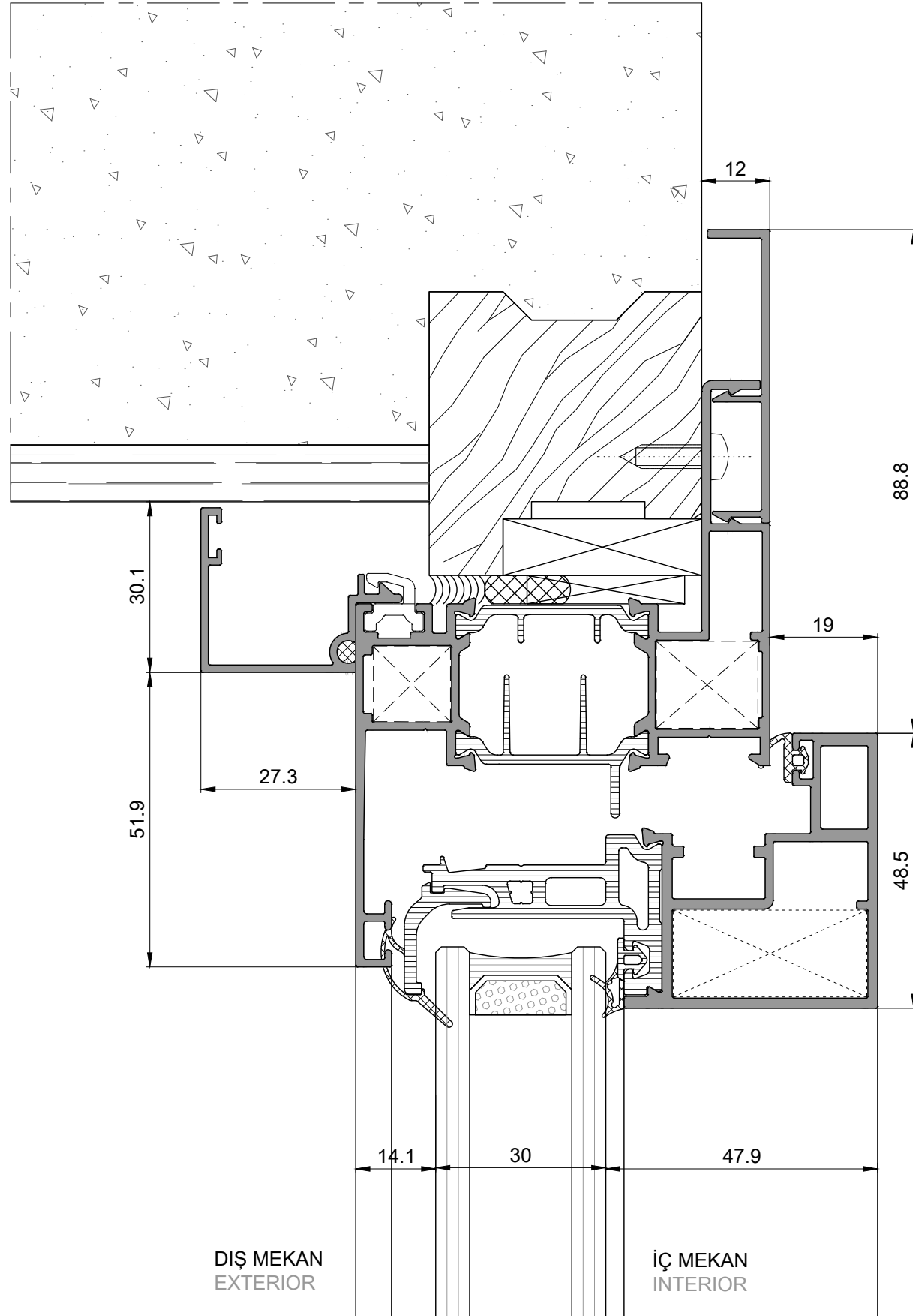
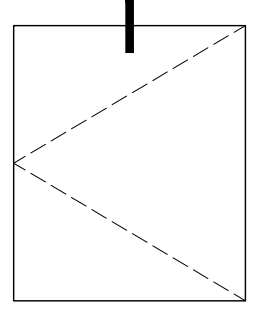

KLASİK MONTAJLI KASA ÜST DETAY
pose classique en tunnel top detail

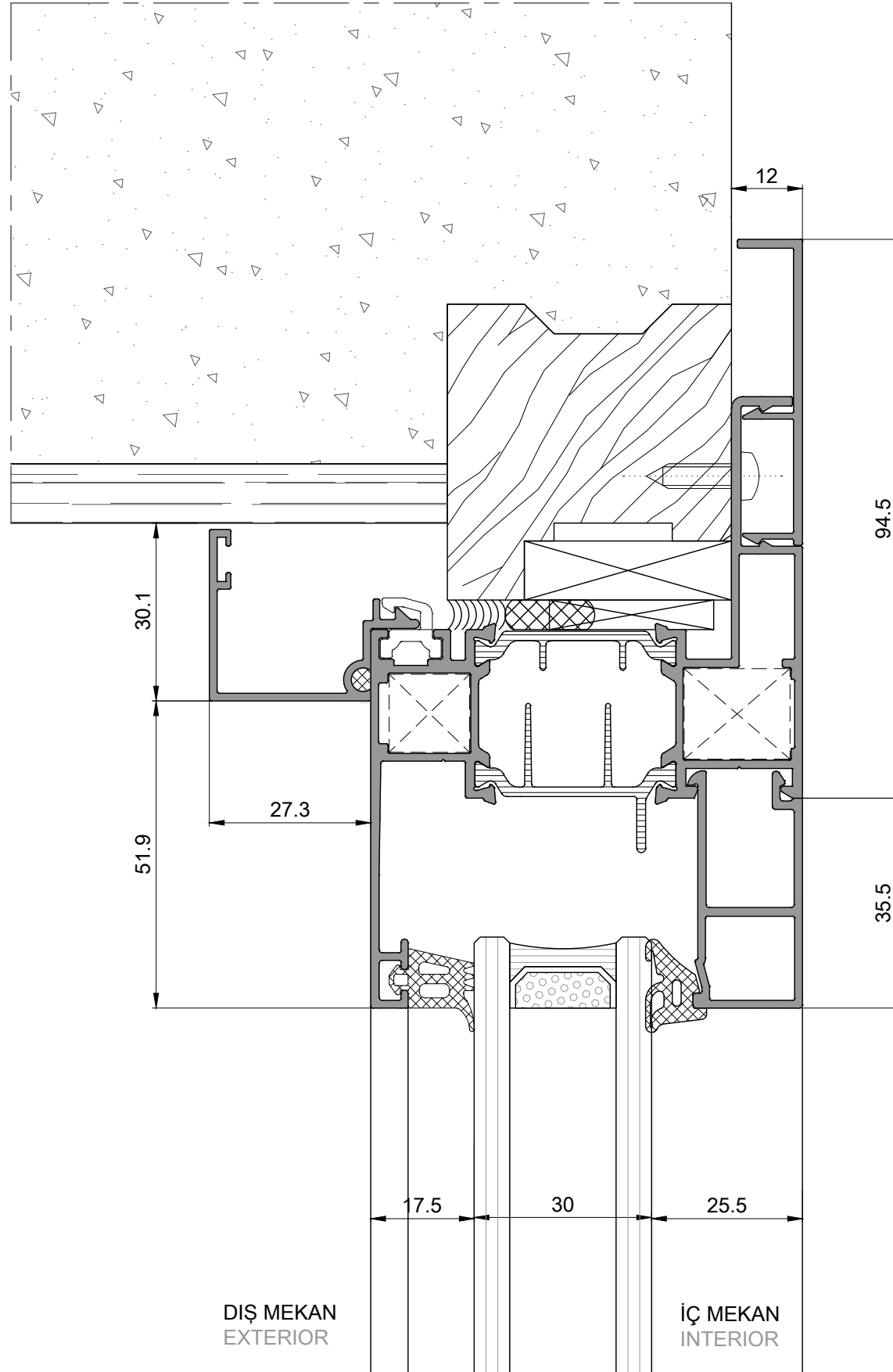
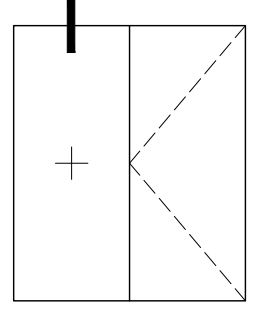

KLASİK MONTAJLI KASA ALT DETAY
pose classique en tunnel bottom detail

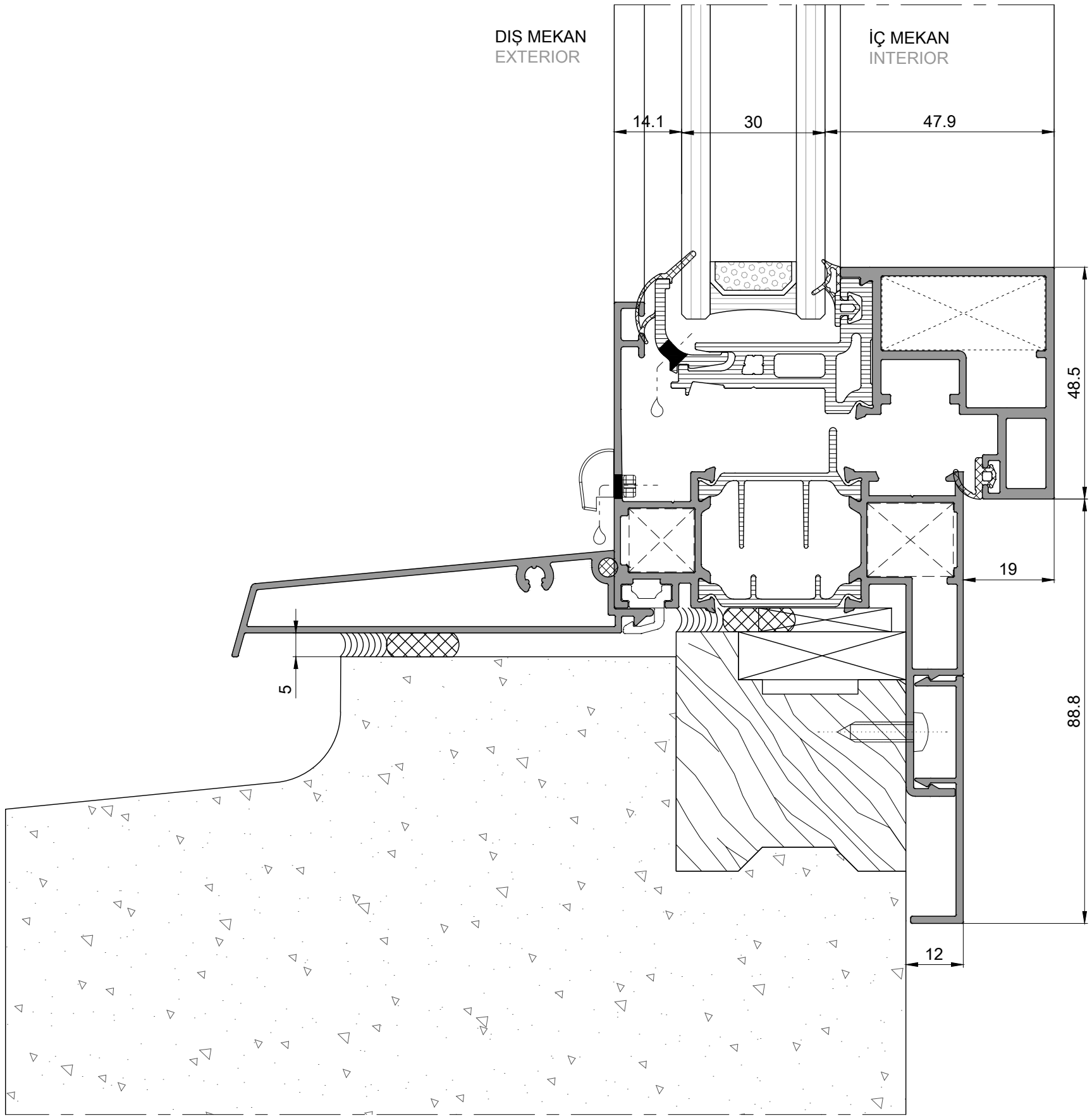
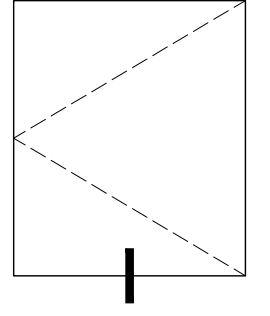

KAPI ALT EŞİK DETAY
Door bottom side threshold detail

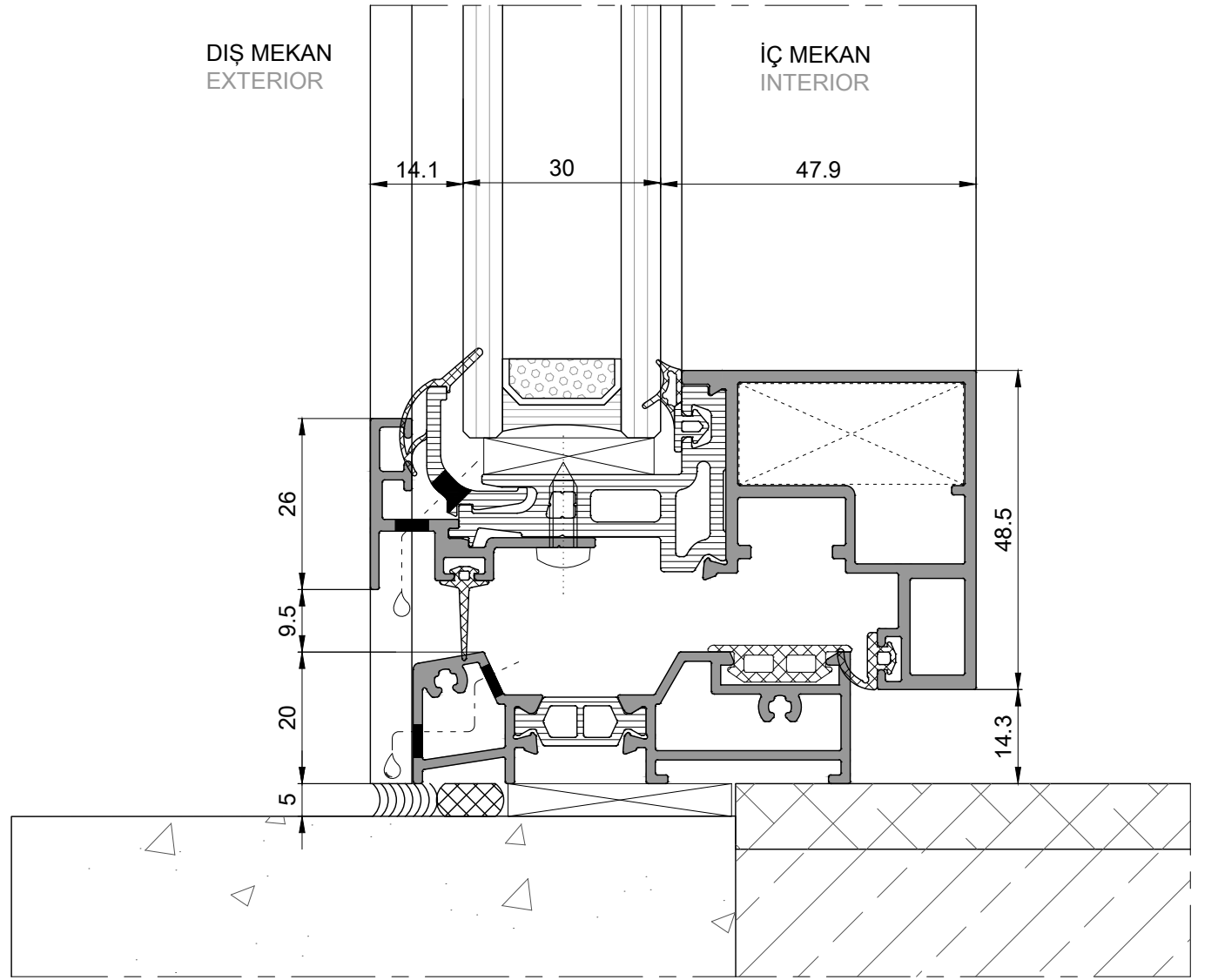
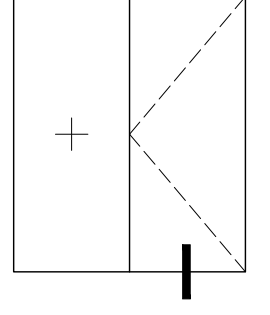

SABİT ALT DETAY
fixed glass bottom detail

